

David Cox John Little Donal O'Shea

# IDEALS, VARIETIES, AND ALGORITHMS

An Introduction to Computational Algebraic  
Geometry and Commutative Algebra

Third Edition



Springer

# Undergraduate Texts in Mathematics

*Editors*

S. Axler

K.A. Ribet

# Undergraduate Texts in Mathematics

---

- Abbott:** Understanding Analysis.
- Anglin:** Mathematics: A Concise History and Philosophy.  
*Readings in Mathematics.*
- Anglin/Lambek:** The Heritage of Thales.  
*Readings in Mathematics.*
- Apostol:** Introduction to Analytic Number Theory. Second edition.
- Armstrong:** Basic Topology.
- Armstrong:** Groups and Symmetry.
- Axler:** Linear Algebra Done Right. Second edition.
- Beardon:** Limits: A New Approach to Real Analysis.
- Bak/Newman:** Complex Analysis. Second edition.
- Banchoff/Wermer:** Linear Algebra Through Geometry. Second edition.
- Berberian:** A First Course in Real Analysis.
- Bix:** Conics and Cubics: A Concrete Introduction to Algebraic Curves.
- Brémaud:** An Introduction to Probabilistic Modeling.
- Bressoud:** Factorization and Primality Testing.
- Bressoud:** Second Year Calculus.  
*Readings in Mathematics.*
- Brickman:** Mathematical Introduction to Linear Programming and Game Theory.
- Browder:** Mathematical Analysis: An Introduction.
- Buchmann:** Introduction to Cryptography. Second edition.
- Buskes/van Rooij:** Topological Spaces: From Distance to Neighborhood.
- Callahan:** The Geometry of Spacetime: An Introduction to Special and General Relativity.
- Carter/van Brunt:** The Lebesgue–Stieltjes Integral: A Practical Introduction.
- Cederberg:** A Course in Modern Geometries. Second edition.
- Chambert-Loir:** A Field Guide to Algebra
- Childs:** A Concrete Introduction to Higher Algebra. Second edition.
- Chung/AitSahlia:** Elementary Probability Theory: With Stochastic Processes and an Introduction to Mathematical Finance. Fourth edition.
- Cox/Little/O’Shea:** Ideals, Varieties, and Algorithms. Third edition.
- Croom:** Basic Concepts of Algebraic Topology.
- Cull/Flahive/Robson:** Difference Equations. From Rabbits to Chaos.
- Curtis:** Linear Algebra: An Introductory Approach. Fourth edition.
- Daepf/Gorkin:** Reading, Writing, and Proving: A Closer Look at Mathematics.
- Devlin:** The Joy of Sets: Fundamentals of Contemporary Set Theory. Second edition.
- Dixmier:** General Topology.
- Driver:** Why Math?
- Ebbinghaus/Flum/Thomas:** Mathematical Logic. Second edition.
- Edgar:** Measure, Topology, and Fractal Geometry.
- Elaydi:** An Introduction to Difference Equations. Third edition.
- Erdős/Surányi:** Topics in the Theory of Numbers.
- Estep:** Practical Analysis on One Variable.
- Exner:** An Accompaniment to Higher Mathematics.
- Exner:** Inside Calculus.
- Fine/Rosenberger:** The Fundamental Theory of Algebra.
- Fischer:** Intermediate Real Analysis.
- Flanigan/Kazdan:** Calculus Two: Linear and Nonlinear Functions. Second edition.
- Fleming:** Functions of Several Variables. Second edition.
- Foulds:** Combinatorial Optimization for Undergraduates.
- Foulds:** Optimization Techniques: An Introduction.
- Franklin:** Methods of Mathematical Economics.
- Frazier:** An Introduction to Wavelets Through Linear Algebra.
- Gamelin:** Complex Analysis.
- Ghorpade/Limaye:** A Course in Calculus and Real Analysis.
- Gordon:** Discrete Probability.
- Hairer/Wanner:** Analysis by Its History.  
*Readings in Mathematics.*
- Halmos:** Finite-Dimensional Vector Spaces. Second edition.
- Halmos:** Naive Set Theory.
- Hämmerlin/Hoffmann:** Numerical Mathematics.  
*Readings in Mathematics.*
- Harris/Hirst/Mossinghoff:** Combinatorics and Graph Theory.
- Hartshorne:** Geometry: Euclid and Beyond.
- Hijab:** Introduction to Calculus and Classical Analysis.
- Hilton/Holton/Pedersen:** Mathematical Reflections: In a Room with Many Mirrors.
- Hilton/Holton/Pedersen:** Mathematical Vistas: From a Room with Many Windows.

(continued after index)

David Cox John Little Donal O'Shea

# Ideals, Varieties, and Algorithms

An Introduction to Computational Algebraic  
Geometry and Commutative Algebra

Third Edition

 Springer

David Cox  
Department of Mathematics  
and Computer Science  
Amherst College  
Amherst, MA 01002-5000  
USA

John Little  
Department of Mathematics  
and Computer Science  
College of the Holy Cross  
Worcester, MA 01610-2395  
USA

Donal O'Shea  
Department of Mathematics  
and Statistics  
Mount Holyoke College  
South Hadley, MA 01075-1493  
USA

*Editorial Board*

S. Axler  
Mathematics Department  
San Francisco State  
University  
San Francisco, CA 94132  
USA

K.A. Ribet  
Department of Mathematics  
University of California  
at Berkeley  
Berkeley, CA 94720-3840  
USA

ISBN: 978-0-387-35650-1

e-ISBN: 978-0-387-35651-8

Library of Congress Control Number: 2006930875

Mathematics Subject Classification (2000): 14-01, 13-01, 13Pxx

© 2007, 1997, 1992 Springer Science+Business Media, LLC

All rights reserved. This work may not be translated or copied in whole or in part without the written permission of the publisher (Springer Science+Business Media, LLC, 233 Spring Street, New York, NY 10013, USA), except for brief excerpts in connection with reviews or scholarly analysis. Use in connection with any form of information storage and retrieval, electronic adaptation, computer software, or by similar or dissimilar methodology now known or hereafter developed is forbidden.

The use in this publication of trade names, trademarks, service marks, and similar terms, even if they are not identified as such, is not to be taken as an expression of opinion as to whether or not they are subject to proprietary rights.

Printed on acid-free paper

9 8 7 6 5 4 3 (Corrected at 3<sup>rd</sup> printing 2012)

springer.com

*To Elaine,  
for her love and support.  
D.A.C.*

*To my mother and the memory of my father.  
J.B.L.*

*To Mary and my children.  
D.O'S.*



# Preface to the First Edition

We wrote this book to introduce undergraduates to some interesting ideas in algebraic geometry and commutative algebra. Until recently, these topics involved a lot of abstract mathematics and were only taught in graduate school. But in the 1960s, Buchberger and Hironaka discovered new algorithms for manipulating systems of polynomial equations. Fueled by the development of computers fast enough to run these algorithms, the last two decades have seen a minor revolution in commutative algebra. The ability to compute efficiently with polynomial equations has made it possible to investigate complicated examples that would be impossible to do by hand, and has changed the practice of much research in algebraic geometry. This has also enhanced the importance of the subject for computer scientists and engineers, who have begun to use these techniques in a whole range of problems.

It is our belief that the growing importance of these computational techniques warrants their introduction into the undergraduate (and graduate) mathematics curriculum. Many undergraduates enjoy the concrete, almost nineteenth-century, flavor that a computational emphasis brings to the subject. At the same time, one can do some substantial mathematics, including the Hilbert Basis Theorem, Elimination Theory, and the Nullstellensatz.

The mathematical prerequisites of the book are modest: the students should have had a course in linear algebra and a course where they learned how to do proofs. Examples of the latter sort of course include discrete math and abstract algebra. It is important to note that abstract algebra is *not* a prerequisite. On the other hand, if all of the students have had abstract algebra, then certain parts of the course will go much more quickly.

The book assumes that the students will have access to a computer algebra system. Appendix C describes the features of AXIOM, Maple, Mathematica, and REDUCE that are most relevant to the text. We do not assume any prior experience with a computer. However, many of the algorithms in the book are described in pseudocode, which may be unfamiliar to students with no background in programming. Appendix B contains a careful description of the pseudocode that we use in the text.

In writing the book, we tried to structure the material so that the book could be used in a variety of courses, and at a variety of different levels. For instance, the book could serve as a basis of a second course in undergraduate abstract algebra, but we think that it just as easily could provide a credible alternative to the first course. Although the



book is aimed primarily at undergraduates, it could also be used in various graduate courses, with some supplements. In particular, beginning graduate courses in algebraic geometry or computational algebra may find the text useful. We hope, of course, that mathematicians and colleagues in other disciplines will enjoy reading the book as much as we enjoyed writing it.

The first four chapters form the core of the book. It should be possible to cover them in a 14-week semester, and there may be some time left over at the end to explore other parts of the text. The following chart explains the logical dependence of the chapters:

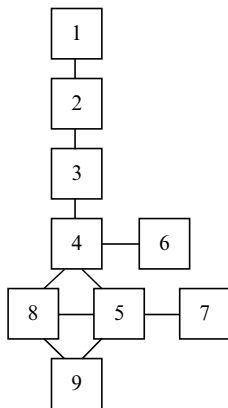

See the table of contents for a description of what is covered in each chapter. As the chart indicates, there are a variety of ways to proceed after covering the first four chapters. Also, a two-semester course could be designed that covers the entire book. For instructors interested in having their students do an independent project, we have included a list of possible topics in Appendix D.

It is a pleasure to thank the New England Consortium for Undergraduate Science Education (and its parent organization, the Pew Charitable Trusts) for providing the major funding for this work. The project would have been impossible without their support. Various aspects of our work were also aided by grants from IBM and the Sloan Foundation, the Alexander von Humboldt Foundation, the Department of Education's FIPSE program, the Howard Hughes Foundation, and the National Science Foundation. We are grateful for their help.

We also wish to thank colleagues and students at Amherst College, George Mason University, Holy Cross College, Massachusetts Institute of Technology, Mount Holyoke College, Smith College, and the University of Massachusetts who participated in courses based on early versions of the manuscript. Their feedback improved the book considerably. Many other colleagues have contributed suggestions, and we thank you all.

Corrections, comments and suggestions for improvement are welcome!

November 1991

*David Cox  
John Little  
Donal O'Shea*

# Preface to the Second Edition

In preparing a new edition of *Ideals, Varieties, and Algorithms*, our goal was to correct some of the omissions of the first edition while maintaining the readability and accessibility of the original. The major changes in the second edition are as follows:

- Chapter 2: A better acknowledgement of Buchberger's contributions and an improved proof of the Buchberger Criterion in §6.
- Chapter 5: An improved bound on the number of solutions in §3 and a new §6 which completes the proof of the Closure Theorem begun in Chapter 3.
- Chapter 8: A complete proof of the Projection Extension Theorem in §5 and a new §7 which contains a proof of Bezout's Theorem.
- Appendix C: a new section on AXIOM and an update on what we say about Maple, Mathematica, and REDUCE.

Finally, we fixed some typographical errors, improved and clarified notation, and updated the bibliography by adding many new references.

We also want to take this opportunity to acknowledge our debt to the many people who influenced us and helped us in the course of this project. In particular, we would like to thank:

- David Bayer and Monique Lejeune-Jalabert, whose thesis BAYER (1982) and notes LEJEUNE-JALABERT (1985) first acquainted us with this wonderful subject.
- Frances Kirwan, whose book KIRWAN (1992) convinced us to include Bezout's Theorem in Chapter 8.
- Steven Kleiman, who showed us how to prove the Closure Theorem in full generality. His proof appears in Chapter 5.
- Michael Singer, who suggested improvements in Chapter 5, including the new Proposition 8 of §3.
- Bernd Sturmfels, whose book STURMFELS (1993) was the inspiration for Chapter 7.

There are also many individuals who found numerous typographical errors and gave us feedback on various aspects of the book. We are grateful to you all!

As with the first edition, we welcome comments and suggestions, and we pay \$1 for every new typographical error. For a list of errors and other information relevant to the book, see our web site <http://www.cs.amherst.edu/~dac/iva.html>.

October 1996

*David Cox*  
*John Little*  
*Donal O'Shea*

# Preface to the Third Edition

The new features of the third edition of *Ideals, Varieties, and Algorithms* are as follows:

- A significantly shorter proof of the Extension Theorem is presented in §6 of Chapter 3. We are grateful to A. H. M. Levelt for bringing this argument to our attention.
- A major update of the section on Maple appears in Appendix C. We also give updated information on AXIOM, CoCoA, Macaulay 2, Magma, Mathematica, and SINGULAR.
- Changes have been made on over 200 pages to enhance clarity and correctness.

We are also grateful to the many individuals who reported typographical errors and gave us feedback on the earlier editions. Thank you all!

As with the first and second editions, we welcome comments and suggestions, and we pay \$1 for every new typographical error.

November, 2006

*David Cox*  
*John Little*  
*Donal O'Shea*



# Contents

<b>Preface to the First Edition</b>	<b>vii</b>
<b>Preface to the Second Edition</b>	<b>ix</b>
<b>Preface to the Third Edition</b>	<b>xi</b>
<b>1. Geometry, Algebra, and Algorithms</b>	<b>1</b>
§1. Polynomials and Affine Space . . . . .	1
§2. Affine Varieties . . . . .	5
§3. Parametrizations of Affine Varieties . . . . .	14
§4. Ideals . . . . .	29
§5. Polynomials of One Variable . . . . .	38
<b>2. Groebner Bases</b>	<b>49</b>
§1. Introduction . . . . .	49
§2. Orderings on the Monomials in $k[x_1, \dots, x_n]$ . . . . .	54
§3. A Division Algorithm in $k[x_1, \dots, x_n]$ . . . . .	61
§4. Monomial Ideals and Dickson's Lemma . . . . .	69
§5. The Hilbert Basis Theorem and Groebner Bases . . . . .	75
§6. Properties of Groebner Bases . . . . .	82
§7. Buchberger's Algorithm . . . . .	88
§8. First Applications of Groebner Bases . . . . .	95
§9. (Optional) Improvements on Buchberger's Algorithm . . . . .	102
<b>3. Elimination Theory</b>	<b>115</b>
§1. The Elimination and Extension Theorems . . . . .	115
§2. The Geometry of Elimination . . . . .	123
§3. Implicitization . . . . .	128
§4. Singular Points and Envelopes . . . . .	137
§5. Unique Factorization and Resultants . . . . .	150
§6. Resultants and the Extension Theorem . . . . .	162

<b>4. The Algebra–Geometry Dictionary</b>	<b>169</b>
§1. Hilbert’s Nullstellensatz . . . . .	169
§2. Radical Ideals and the Ideal–Variety Correspondence . . . . .	175
§3. Sums, Products, and Intersections of Ideals . . . . .	183
§4. Zariski Closure and Quotients of Ideals . . . . .	193
§5. Irreducible Varieties and Prime Ideals . . . . .	198
§6. Decomposition of a Variety into Irreducibles . . . . .	204
§7. (Optional) Primary Decomposition of Ideals . . . . .	210
§8. Summary . . . . .	214
<b>5. Polynomial and Rational Functions on a Variety</b>	<b>215</b>
§1. Polynomial Mappings . . . . .	215
§2. Quotients of Polynomial Rings . . . . .	221
§3. Algorithmic Computations in $k[x_1, \dots, x_n]/I$ . . . . .	230
§4. The Coordinate Ring of an Affine Variety . . . . .	239
§5. Rational Functions on a Variety . . . . .	248
§6. (Optional) Proof of the Closure Theorem . . . . .	258
<b>6. Robotics and Automatic Geometric Theorem Proving</b>	<b>265</b>
§1. Geometric Description of Robots . . . . .	265
§2. The Forward Kinematic Problem . . . . .	271
§3. The Inverse Kinematic Problem and Motion Planning . . . . .	279
§4. Automatic Geometric Theorem Proving . . . . .	291
§5. Wu’s Method . . . . .	307
<b>7. Invariant Theory of Finite Groups</b>	<b>317</b>
§1. Symmetric Polynomials . . . . .	317
§2. Finite Matrix Groups and Rings of Invariants . . . . .	327
§3. Generators for the Ring of Invariants . . . . .	336
§4. Relations Among Generators and the Geometry of Orbits . . . . .	345
<b>8. Projective Algebraic Geometry</b>	<b>357</b>
§1. The Projective Plane . . . . .	357
§2. Projective Space and Projective Varieties . . . . .	368
§3. The Projective Algebra–Geometry Dictionary . . . . .	379
§4. The Projective Closure of an Affine Variety . . . . .	386
§5. Projective Elimination Theory . . . . .	393
§6. The Geometry of Quadric Hypersurfaces . . . . .	408
§7. Bezout’s Theorem . . . . .	422
<b>9. The Dimension of a Variety</b>	<b>439</b>
§1. The Variety of a Monomial Ideal . . . . .	439
§2. The Complement of a Monomial Ideal . . . . .	443

§3. The Hilbert Function and the Dimension of a Variety . . . . .	456
§4. Elementary Properties of Dimension . . . . .	468
§5. Dimension and Algebraic Independence . . . . .	477
§6. Dimension and Nonsingularity . . . . .	484
§7. The Tangent Cone . . . . .	495
<b>Appendix A. Some Concepts from Algebra</b>	<b>509</b>
§1. Fields and Rings . . . . .	509
§2. Groups . . . . .	510
§3. Determinants . . . . .	511
<b>Appendix B. Pseudocode</b>	<b>513</b>
§1. Inputs, Outputs, Variables, and Constants . . . . .	513
§2. Assignment Statements . . . . .	514
§3. Looping Structures . . . . .	514
§4. Branching Structures . . . . .	515
<b>Appendix C. Computer Algebra Systems</b>	<b>517</b>
§1. AXIOM . . . . .	517
§2. Maple . . . . .	520
§3. Mathematica . . . . .	522
§4. REDUCE . . . . .	524
§5. Other Systems . . . . .	528
<b>Appendix D. Independent Projects</b>	<b>530</b>
§1. General Comments . . . . .	530
§2. Suggested Projects . . . . .	530
<b>References</b>	<b>535</b>
<b>Index</b>	<b>541</b>





# 1

## Geometry, Algebra, and Algorithms

This chapter will introduce some of the basic themes of the book. The geometry we are interested in concerns *affine varieties*, which are curves and surfaces (and higher dimensional objects) defined by polynomial equations. To understand affine varieties, we will need some algebra, and in particular, we will need to study *ideals* in the polynomial ring  $k[x_1, \dots, x_n]$ . Finally, we will discuss polynomials in one variable to illustrate the role played by *algorithms*.

### §1 Polynomials and Affine Space

To link algebra and geometry, we will study polynomials over a field. We all know what polynomials are, but the term *field* may be unfamiliar. The basic intuition is that a field is a set where one can define addition, subtraction, multiplication, and division with the usual properties. Standard examples are the real numbers  $\mathbb{R}$  and the complex numbers  $\mathbb{C}$ , whereas the integers  $\mathbb{Z}$  are not a field since division fails (3 and 2 are integers, but their quotient  $3/2$  is not). A formal definition of field may be found in Appendix A.

One reason that fields are important is that linear algebra works over *any* field. Thus, even if your linear algebra course restricted the scalars to lie in  $\mathbb{R}$  or  $\mathbb{C}$ , most of the theorems and techniques you learned apply to an arbitrary field  $k$ . In this book, we will employ different fields for different purposes. The most commonly used fields will be:

- The rational numbers  $\mathbb{Q}$ : the field for most of our computer examples.
- The real numbers  $\mathbb{R}$ : the field for drawing pictures of curves and surfaces.
- The complex numbers  $\mathbb{C}$ : the field for proving many of our theorems.

On occasion, we will encounter other fields, such as fields of rational functions (which will be defined later). There is also a very interesting theory of finite fields—see the exercises for one of the simpler examples.

We can now define polynomials. The reader certainly is familiar with polynomials in one and two variables, but we will need to discuss polynomials in  $n$  variables  $x_1, \dots, x_n$  with coefficients in an arbitrary field  $k$ . We start by defining monomials.

**Definition 1.** A **monomial** in  $x_1, \dots, x_n$  is a product of the form

$$x_1^{\alpha_1} \cdot x_2^{\alpha_2} \cdots x_n^{\alpha_n},$$

where all of the exponents  $\alpha_1, \dots, \alpha_n$  are nonnegative integers. The **total degree** of this monomial is the sum  $\alpha_1 + \dots + \alpha_n$ .

We can simplify the notation for monomials as follows: let  $\alpha = (\alpha_1, \dots, \alpha_n)$  be an  $n$ -tuple of nonnegative integers. Then we set

$$x^\alpha = x_1^{\alpha_1} \cdot x_2^{\alpha_2} \cdots x_n^{\alpha_n}.$$

When  $\alpha = (0, \dots, 0)$ , note that  $x^\alpha = 1$ . We also let  $|\alpha| = \alpha_1 + \dots + \alpha_n$  denote the total degree of the monomial  $x^\alpha$ .

**Definition 2.** A **polynomial**  $f$  in  $x_1, \dots, x_n$  with coefficients in  $k$  is a finite linear combination (with coefficients in  $k$ ) of monomials. We will write a polynomial  $f$  in the form

$$f = \sum_{\alpha} a_{\alpha} x^{\alpha}, \quad a_{\alpha} \in k,$$

where the sum is over a finite number of  $n$ -tuples  $\alpha = (\alpha_1, \dots, \alpha_n)$ . The set of all polynomials in  $x_1, \dots, x_n$  with coefficients in  $k$  is denoted  $k[x_1, \dots, x_n]$ .

When dealing with polynomials in a small number of variables, we will usually dispense with subscripts. Thus, polynomials in one, two, and three variables lie in  $k[x]$ ,  $k[x, y]$  and  $k[x, y, z]$ , respectively. For example,

$$f = 2x^3y^2z + \frac{3}{2}y^3z^3 - 3xyz + y^2$$

is a polynomial in  $\mathbb{Q}[x, y, z]$ . We will usually use the letters  $f, g, h, p, q, r$  to refer to polynomials.

We will use the following terminology in dealing with polynomials.

**Definition 3.** Let  $f = \sum_{\alpha} a_{\alpha} x^{\alpha}$  be a polynomial in  $k[x_1, \dots, x_n]$ .

- (i) We call  $a_{\alpha}$  the **coefficient** of the monomial  $x^{\alpha}$ .
- (ii) If  $a_{\alpha} \neq 0$ , then we call  $a_{\alpha} x^{\alpha}$  a **term** of  $f$ .
- (iii) The **total degree** of  $f$ , denoted  $\deg(f)$ , is the maximum  $|\alpha|$  such that the coefficient  $a_{\alpha}$  is nonzero.

As an example, the polynomial  $f = 2x^3y^2z + \frac{3}{2}y^3z^3 - 3xyz + y^2$  given above has four terms and total degree six. Note that there are two terms of maximal total degree, which is something that cannot happen for polynomials of one variable. In Chapter 2, we will study how to *order* the terms of a polynomial.

The sum and product of two polynomials is again a polynomial. We say that a polynomial  $f$  *divides* a polynomial  $g$  provided that  $g = fh$  for some  $h \in k[x_1, \dots, x_n]$ .

One can show that, under addition and multiplication,  $k[x_1, \dots, x_n]$  satisfies all of the field axioms except for the existence of multiplicative inverses (because, for example,  $1/x_1$  is not a polynomial). Such a mathematical structure is called a commutative ring

(see Appendix A for the full definition), and for this reason we will refer to  $k[x_1, \dots, x_n]$  as a *polynomial ring*.

The next topic to consider is affine space.

**Definition 4.** *Given a field  $k$  and a positive integer  $n$ , we define the  $n$ -dimensional affine space over  $k$  to be the set*

$$k^n = \{(a_1, \dots, a_n) : a_1, \dots, a_n \in k\}.$$

For an example of affine space, consider the case  $k = \mathbb{R}$ . Here we get the familiar space  $\mathbb{R}^n$  from calculus and linear algebra. In general, we call  $k^1 = k$  the *affine line* and  $k^2$  the *affine plane*.

Let us next see how polynomials relate to affine space. The key idea is that a polynomial  $f = \sum_{\alpha} a_{\alpha} x^{\alpha} \in k[x_1, \dots, x_n]$  gives a function

$$f : k^n \rightarrow k$$

defined as follows: given  $(a_1, \dots, a_n) \in k^n$ , replace every  $x_i$  by  $a_i$  in the expression for  $f$ . Since all of the coefficients also lie in  $k$ , this operation gives an element  $f(a_1, \dots, a_n) \in k$ . The ability to regard a polynomial as a function is what makes it possible to link algebra and geometry.

This dual nature of polynomials has some unexpected consequences. For example, the question “is  $f = 0$ ?” now has two potential meanings: is  $f$  the zero polynomial?, which means that all of its coefficients  $a_{\alpha}$  are zero, or is  $f$  the zero function?, which means that  $f(a_1, \dots, a_n) = 0$  for all  $(a_1, \dots, a_n) \in k^n$ . The surprising fact is that these two statements are not equivalent in general. For an example of how they can differ, consider the set consisting of the two elements 0 and 1. In the exercises, we will see that this can be made into a field where  $1 + 1 = 0$ . This field is usually called  $\mathbb{F}_2$ . Now consider the polynomial  $x^2 - x = x(x - 1) \in \mathbb{F}_2[x]$ . Since this polynomial vanishes at 0 and 1, we have found a nonzero polynomial which gives the zero function on the affine space  $\mathbb{F}_2^1$ . Other examples will be discussed in the exercises.

However, as long as  $k$  is infinite, there is no problem.

**Proposition 5.** *Let  $k$  be an infinite field, and let  $f \in k[x_1, \dots, x_n]$ . Then  $f = 0$  in  $k[x_1, \dots, x_n]$  if and only if  $f : k^n \rightarrow k$  is the zero function.*

**Proof.** One direction of the proof is obvious since the zero polynomial clearly gives the zero function. To prove the converse, we need to show that if  $f(a_1, \dots, a_n) = 0$  for all  $(a_1, \dots, a_n) \in k^n$ , then  $f$  is the zero polynomial. We will use induction on the number of variables  $n$ .

When  $n = 1$ , it is well known that a nonzero polynomial in  $k[x]$  of degree  $m$  has at most  $m$  distinct roots (we will prove this fact in Corollary 3 of §5). For our particular  $f \in k[x]$ , we are assuming  $f(a) = 0$  for all  $a \in k$ . Since  $k$  is infinite, this means that  $f$  has infinitely many roots, and, hence,  $f$  must be the zero polynomial.

Now assume that the converse is true for  $n - 1$ , and let  $f \in k[x_1, \dots, x_n]$  be a polynomial that vanishes at all points of  $k^n$ . By collecting the various powers of  $x_n$ , we

can write  $f$  in the form

$$f = \sum_{i=0}^N g_i(x_1, \dots, x_{n-1})x_n^i,$$

where  $g_i \in k[x_1, \dots, x_{n-1}]$ . We will show that each  $g_i$  is the zero polynomial in  $n - 1$  variables, which will force  $f$  to be the zero polynomial in  $k[x_1, \dots, x_n]$ .

If we fix  $(a_1, \dots, a_{n-1}) \in k^{n-1}$ , we get the polynomial  $f(a_1, \dots, a_{n-1}, x_n) \in k[x_n]$ . By our hypothesis on  $f$ , this vanishes for every  $a_n \in k$ . It follows from the case  $n = 1$  that  $f(a_1, \dots, a_{n-1}, x_n)$  is the zero polynomial in  $k[x_n]$ . Using the above formula for  $f$ , we see that the coefficients of  $f(a_1, \dots, a_{n-1}, x_n)$  are  $g_i(a_1, \dots, a_{n-1})$ , and thus,  $g_i(a_1, \dots, a_{n-1}) = 0$  for all  $i$ . Since  $(a_1, \dots, a_{n-1})$  was arbitrarily chosen in  $k^{n-1}$ , it follows that each  $g_i \in k[x_1, \dots, x_{n-1}]$  gives the zero function on  $k^{n-1}$ . Our inductive assumption then implies that each  $g_i$  is the zero polynomial in  $k[x_1, \dots, x_{n-1}]$ . This forces  $f$  to be the zero polynomial in  $k[x_1, \dots, x_n]$  and completes the proof of the proposition.  $\square$

Note that in the statement of Proposition 5, the assertion “ $f = 0$  in  $k[x_1, \dots, x_n]$ ” means that  $f$  is the zero polynomial, i.e., that every coefficient of  $f$  is zero. Thus, we use the same symbol “0” to stand for the zero element of  $k$  and the zero polynomial in  $k[x_1, \dots, x_n]$ . The context will make clear which one we mean.

As a corollary, we see that two polynomials over an infinite field are equal precisely when they give the same function on affine space.

**Corollary 6.** *Let  $k$  be an infinite field, and let  $f, g \in k[x_1, \dots, x_n]$ . Then  $f = g$  in  $k[x_1, \dots, x_n]$  if and only if  $f : k^n \rightarrow k$  and  $g : k^n \rightarrow k$  are the same function.*

**Proof.** To prove the nontrivial direction, suppose that  $f, g \in k[x_1, \dots, x_n]$  give the same function on  $k^n$ . By hypothesis, the polynomial  $f - g$  vanishes at all points of  $k^n$ . Proposition 5 then implies that  $f - g$  is the zero polynomial. This proves that  $f = g$  in  $k[x_1, \dots, x_n]$ .  $\square$

Finally, we need to record a special property of polynomials over the field of complex numbers  $\mathbb{C}$ .

**Theorem 7.** *Every nonconstant polynomial  $f \in \mathbb{C}[x]$  has a root in  $\mathbb{C}$ .*

**Proof.** This is the Fundamental Theorem of Algebra, and proofs can be found in most introductory texts on complex analysis (although many other proofs are known).  $\square$

We say that a field  $k$  is *algebraically closed* if every nonconstant polynomial in  $k[x]$  has a root in  $k$ . Thus  $\mathbb{R}$  is not algebraically closed (what are the roots of  $x^2 + 1$ ?), whereas the above theorem asserts that  $\mathbb{C}$  is algebraically closed. In Chapter 4 we will prove a powerful generalization of Theorem 7 called the Hilbert Nullstellensatz.

## EXERCISES FOR §1

- Let  $\mathbb{F}_2 = \{0, 1\}$ , and define addition and multiplication by  $0 + 0 = 1 + 1 = 0$ ,  $0 + 1 = 1 + 0 = 1$ ,  $0 \cdot 0 = 0 \cdot 1 = 1 \cdot 0 = 0$  and  $1 \cdot 1 = 1$ . Explain why  $\mathbb{F}_2$  is a field. (You need not check the associative and distributive properties, but you should verify the existence of identities and inverses, both additive and multiplicative.)
- Let  $\mathbb{F}_2$  be the field from Exercise 1.
  - Consider the polynomial  $g(x, y) = x^2y + y^2x \in \mathbb{F}_2[x, y]$ . Show that  $g(x, y) = 0$  for every  $(x, y) \in \mathbb{F}_2^2$ , and explain why this does not contradict Proposition 5.
  - Find a nonzero polynomial in  $\mathbb{F}_2[x, y, z]$  which vanishes at every point of  $\mathbb{F}_2^3$ . Try to find one involving all three variables.
  - Find a nonzero polynomial in  $\mathbb{F}_2[x_1, \dots, x_n]$  which vanishes at every point of  $\mathbb{F}_2^n$ . Can you find one in which all of  $x_1, \dots, x_n$  appear?
- (Requires abstract algebra). Let  $p$  be a prime number. The ring of integers modulo  $p$  is a field with  $p$  elements, which we will denote  $\mathbb{F}_p$ .
  - Explain why  $\mathbb{F}_p - \{0\}$  is a group under multiplication.
  - Use Lagrange's Theorem to show that  $a^{p-1} = 1$  for all  $a \in \mathbb{F}_p - \{0\}$ .
  - Prove that  $a^p = a$  for all  $a \in \mathbb{F}_p$ . Hint: Treat the cases  $a = 0$  and  $a \neq 0$  separately.
  - Find a nonzero polynomial in  $\mathbb{F}_p[x]$  which vanishes at every point of  $\mathbb{F}_p$ . Hint: Use part (c).
- (Requires abstract algebra.) Let  $F$  be a finite field with  $q$  elements. Adapt the argument of Exercise 3 to prove that  $x^q - x$  is a nonzero polynomial in  $F[x]$  which vanishes at every point of  $F$ . This shows that Proposition 5 fails for *all* finite fields.
- In the proof of Proposition 5, we took  $f \in k[x_1, \dots, x_n]$  and wrote it as a polynomial in  $x_n$  with coefficients in  $k[x_1, \dots, x_{n-1}]$ . To see what this looks like in a specific case, consider the polynomial

$$f(x, y, z) = x^5y^2z - x^4y^3 + y^5 + x^2z - y^3z + xy + 2x - 5z + 3.$$

- Write  $f$  as a polynomial in  $x$  with coefficients in  $k[y, z]$ .
  - Write  $f$  as a polynomial in  $y$  with coefficients in  $k[x, z]$ .
  - Write  $f$  as a polynomial in  $z$  with coefficients in  $k[x, y]$ .
- Inside of  $\mathbb{C}^n$ , we have the subset  $\mathbb{Z}^n$ , which consists of all points with integer coordinates.
    - Prove that if  $f \in \mathbb{C}[x_1, \dots, x_n]$  vanishes at every point of  $\mathbb{Z}^n$ , then  $f$  is the zero polynomial. Hint: Adapt the proof of Proposition 5.
    - Let  $f \in \mathbb{C}[x_1, \dots, x_n]$ , and let  $M$  be the largest power of any variable that appears in  $f$ . Let  $\mathbb{Z}_{M+1}^n$  be the set of points of  $\mathbb{Z}^n$ , all coordinates of which lie between 1 and  $M + 1$ . Prove that if  $f$  vanishes at all points of  $\mathbb{Z}_{M+1}^n$ , then  $f$  is the zero polynomial.

## §2 Affine Varieties

We can now define the basic geometric object of the book.

**Definition 1.** Let  $k$  be a field, and let  $f_1, \dots, f_s$  be polynomials in  $k[x_1, \dots, x_n]$ . Then we set

$$\mathbf{V}(f_1, \dots, f_s) = \{(a_1, \dots, a_n) \in k^n : f_i(a_1, \dots, a_n) = 0 \text{ for all } 1 \leq i \leq s\}.$$

We call  $\mathbf{V}(f_1, \dots, f_s)$  the **affine variety** defined by  $f_1, \dots, f_s$ .

Thus, an affine variety  $\mathbf{V}(f_1, \dots, f_s) \subset k^n$  is the set of all solutions of the system of equations  $f_1(x_1, \dots, x_n) = \dots = f_s(x_1, \dots, x_n) = 0$ . We will use the letters  $V$ ,  $W$ , etc. to denote affine varieties. The main purpose of this section is to introduce the reader to *lots* of examples, some new and some familiar. We will use  $k = \mathbb{R}$  so that we can draw pictures.

We begin in the plane  $\mathbb{R}^2$  with the variety  $\mathbf{V}(x^2 + y^2 - 1)$ , which is the circle of radius 1 centered at the origin:

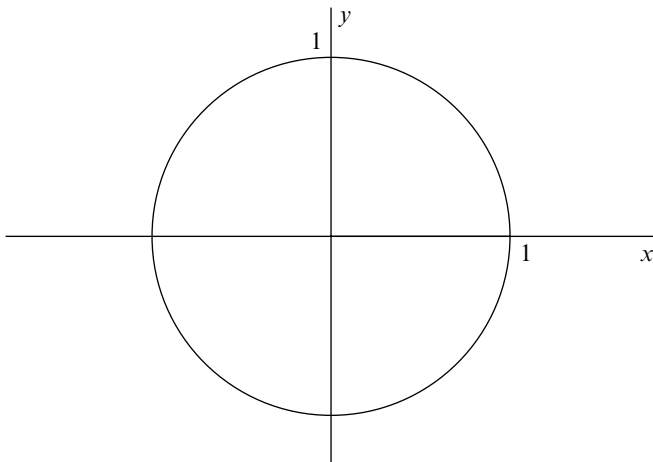

The conic sections studied in analytic geometry (circles, ellipses, parabolas, and hyperbolas) are affine varieties. Likewise, graphs of polynomial functions are affine varieties [the graph of  $y = f(x)$  is  $\mathbf{V}(y - f(x))$ ]. Although not as obvious, graphs of rational functions are also affine varieties. For example, consider the graph of  $y = \frac{x^3 - 1}{x}$ :

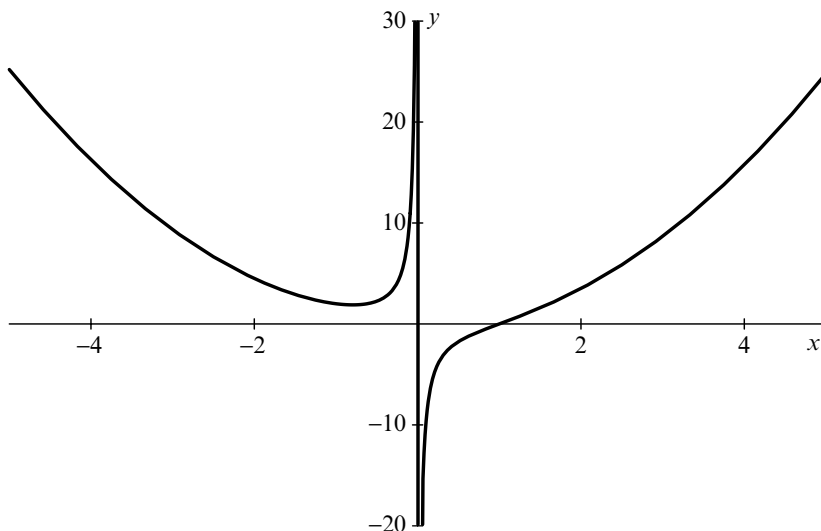

It is easy to check that this is the affine variety  $\mathbf{V}(xy - x^3 + 1)$ .

Next, let us look in the 3-dimensional space  $\mathbb{R}^3$ . A nice affine variety is given by paraboloid of revolution  $\mathbf{V}(z - x^2 - y^2)$ , which is obtained by rotating the parabola  $z = x^2$  about the  $z$ -axis (you can check this using polar coordinates). This gives us the picture:

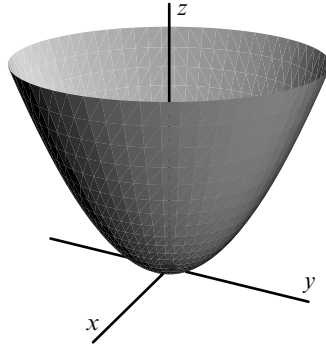

You may also be familiar with the cone  $\mathbf{V}(z^2 - x^2 - y^2)$ :

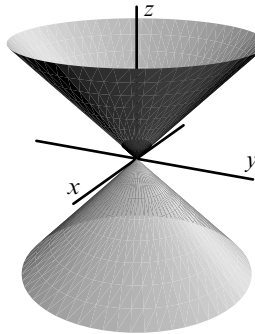

A much more complicated surface is given by  $\mathbf{V}(x^2 - y^2z^2 + z^3)$ :

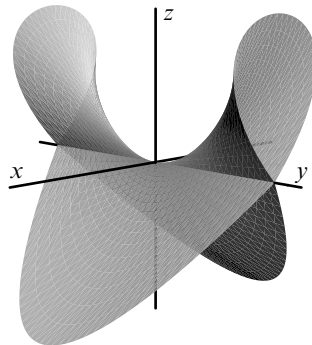



In these last two examples, the surfaces are not smooth everywhere: the cone has a sharp point at the origin, and the last example intersects itself along the whole  $y$ -axis. These are examples of *singular points*, which will be studied later in the book.

An interesting example of a curve in  $\mathbb{R}^3$  is the *twisted cubic*, which is the variety  $\mathbf{V}(y - x^2, z - x^3)$ . For simplicity, we will confine ourselves to the portion that lies in the first octant. To begin, we draw the surfaces  $y = x^2$  and  $z = x^3$  separately:

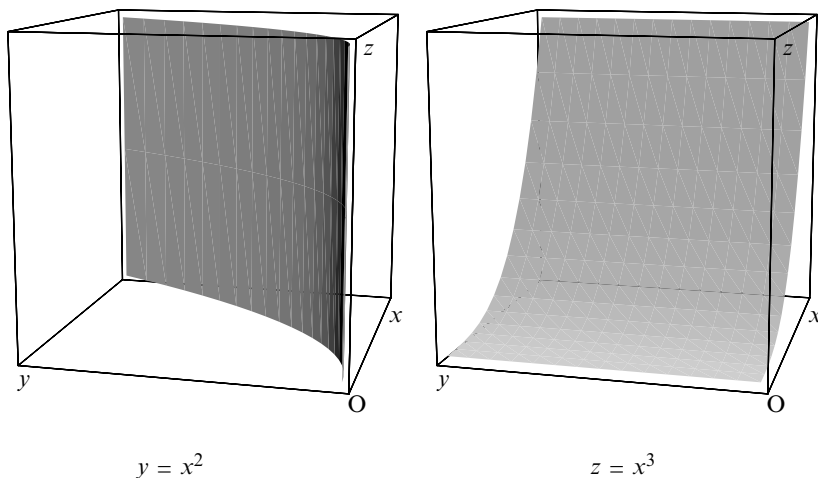

Then their intersection gives the twisted cubic:

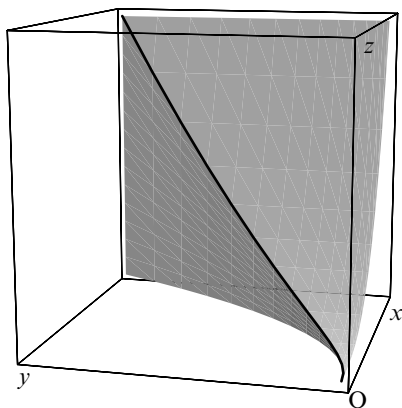

The Twisted Cubic

Notice that when we had one equation in  $\mathbb{R}^2$ , we got a curve, which is a 1-dimensional object. A similar situation happens in  $\mathbb{R}^3$ : one equation in  $\mathbb{R}^3$  usually gives a surface, which has dimension 2. Again, dimension drops by one. But now consider the twisted cubic: here, two equations in  $\mathbb{R}^3$  give a curve, so that dimension drops by two. Since

each equation imposes an extra constraint, intuition suggests that each equation drops the dimension by one. Thus, if we started in  $\mathbb{R}^4$ , one would hope that an affine variety defined by two equations would be a surface. Unfortunately, the notion of dimension is more subtle than indicated by the above examples. To illustrate this, consider the variety  $V(xz, yz)$ . One can easily check that the equations  $xz = yz = 0$  define the union of the  $(x, y)$ -plane and the  $z$ -axis:

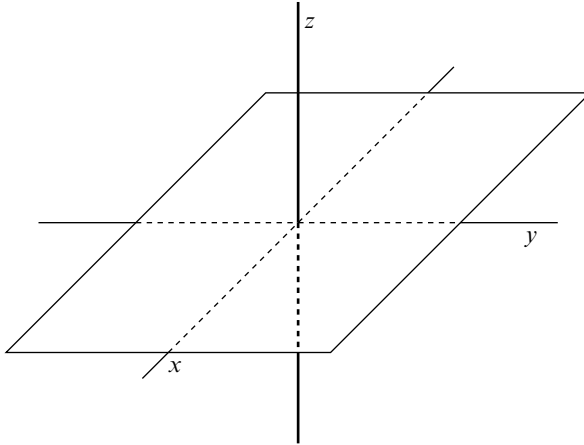

Hence, this variety consists of two pieces which have different dimensions, and one of the pieces (the plane) has the “wrong” dimension according to the above intuition.

We next give some examples of varieties in higher dimensions. A familiar case comes from linear algebra. Namely, fix a field  $k$ , and consider a system of  $m$  linear equations in  $n$  unknowns  $x_1, \dots, x_n$  with coefficients in  $k$ :

$$(1) \quad \begin{aligned} a_{11}x_1 + \cdots + a_{1n}x_n &= b_1, \\ &\vdots \\ a_{m1}x_1 + \cdots + a_{mn}x_n &= b_m. \end{aligned}$$

The solutions of these equations form an affine variety in  $k^n$ , which we will call a *linear variety*. Thus, lines and planes are linear varieties, and there are examples of arbitrarily large dimension. In linear algebra, you learned the method of row reduction (also called Gaussian elimination), which gives an algorithm for finding all solutions of such a system of equations. In Chapter 2, we will study a generalization of this algorithm which applies to systems of polynomial equations.

Linear varieties relate nicely to our discussion of dimension. Namely, if  $V \subset k^n$  is the linear variety defined by (1), then  $V$  need not have dimension  $n - m$  even though  $V$  is defined by  $m$  equations. In fact, when  $V$  is nonempty, linear algebra tells us that  $V$  has dimension  $n - r$ , where  $r$  is the rank of the matrix  $(a_{ij})$ . So for linear varieties, the dimension is determined by the number of *independent* equations. This intuition applies to more general affine varieties, except that the notion of “independent” is more subtle.

Some complicated examples in higher dimensions come from calculus. Suppose, for example, that we wanted to find the minimum and maximum values of  $f(x, y, z) = x^3 + 2xyz - z^2$  subject to the constraint  $g(x, y, z) = x^2 + y^2 + z^2 = 1$ . The method of Lagrange multipliers states that  $\nabla f = \lambda \nabla g$  at a local minimum or maximum [recall that the gradient of  $f$  is the vector of partial derivatives  $\nabla f = (f_x, f_y, f_z)$ ]. This gives us the following system of four equations in four unknowns,  $x, y, z, \lambda$ , to solve:

$$(2) \quad \begin{aligned} 3x^2 + 2yz &= 2x\lambda, \\ 2xz &= 2y\lambda, \\ 2xy - 2z &= 2z\lambda, \\ x^2 + y^2 + z^2 &= 1. \end{aligned}$$

These equations define an affine variety in  $\mathbb{R}^4$ , and our intuition concerning dimension leads us to hope it consists of finitely many points (which have dimension 0) since it is defined by four equations. Students often find Lagrange multipliers difficult because the equations are so hard to solve. The algorithms of Chapter 2 will provide a powerful tool for attacking such problems. In particular, we will find all solutions of the above equations.

We should also mention that affine varieties can be the empty set. For example, when  $k = \mathbb{R}$ , it is obvious that  $\mathbf{V}(x^2 + y^2 + 1) = \emptyset$  since  $x^2 + y^2 = -1$  has no real solutions (although there are solutions when  $k = \mathbb{C}$ ). Another example is  $\mathbf{V}(xy, xy - 1)$ , which is empty no matter what the field is, for a given  $x$  and  $y$  cannot satisfy both  $xy = 0$  and  $xy = 1$ . In Chapter 4 we will study a method for determining when an affine variety over  $\mathbb{C}$  is nonempty.

To give an idea of some of the applications of affine varieties, let us consider a simple example from robotics. Suppose we have a robot arm in the plane consisting of two linked rods of lengths 1 and 2, with the longer rod anchored at the origin:

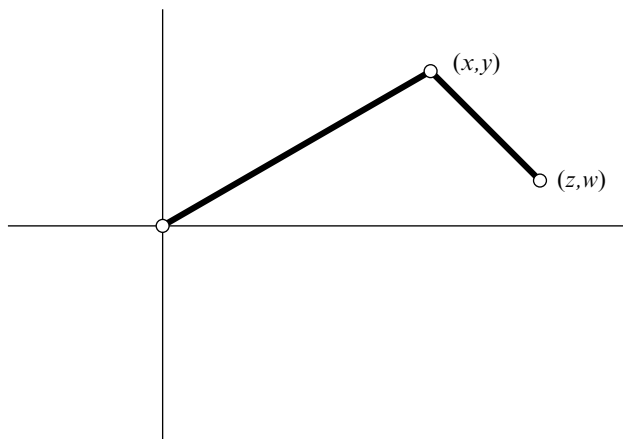

The “state” of the arm is completely described by the coordinates  $(x, y)$  and  $(z, w)$  indicated in the figure. Thus the state can be regarded as a 4-tuple  $(x, y, z, w) \in \mathbb{R}^4$ .

However, not all 4-tuples can occur as states of the arm. In fact, it is easy to see that the subset of possible states is the affine variety in  $\mathbb{R}^4$  defined by the equations

$$\begin{aligned}x^2 + y^2 &= 4, \\(x - z)^2 + (y - w)^2 &= 1.\end{aligned}$$

Notice how even larger dimensions enter quite easily: if we were to consider the same arm in 3-dimensional space, then the variety of states would be defined by two equations in  $\mathbb{R}^6$ . The techniques to be developed in this book have some important applications to the theory of robotics.

So far, all of our drawings have been over  $\mathbb{R}$ . Later in the book, we will consider varieties over  $\mathbb{C}$ . Here, it is more difficult (but not impossible) to get a geometric idea of what such a variety looks like.

Finally, let us record some basic properties of affine varieties.

**Lemma 2.** *If  $V, W \subset k^n$  are affine varieties, then so are  $V \cup W$  and  $V \cap W$ .*

**Proof.** Suppose that  $V = \mathbf{V}(f_1, \dots, f_s)$  and  $W = \mathbf{V}(g_1, \dots, g_t)$ . Then we claim that

$$\begin{aligned}V \cap W &= \mathbf{V}(f_1, \dots, f_s, g_1, \dots, g_t), \\V \cup W &= \mathbf{V}(f_i g_j : 1 \leq i \leq s, 1 \leq j \leq t).\end{aligned}$$

The first equality is trivial to prove: being in  $V \cap W$  means that both  $f_1, \dots, f_s$  and  $g_1, \dots, g_t$  vanish, which is the same as  $f_1, \dots, f_s, g_1, \dots, g_t$  vanishing.

The second equality takes a little more work. If  $(a_1, \dots, a_n) \in V$ , then all of the  $f_i$ 's vanish at this point, which implies that all of the  $f_i g_j$ 's also vanish at  $(a_1, \dots, a_n)$ . Thus,  $V \subset \mathbf{V}(f_i g_j)$ , and  $W \subset \mathbf{V}(f_i g_j)$  follows similarly. This proves that  $V \cup W \subset \mathbf{V}(f_i g_j)$ . Going the other way, choose  $(a_1, \dots, a_n) \in \mathbf{V}(f_i g_j)$ . If this lies in  $V$ , then we are done, and if not, then  $f_{i_0}(a_1, \dots, a_n) \neq 0$  for some  $i_0$ . Since  $f_{i_0} g_j$  vanishes at  $(a_1, \dots, a_n)$  for all  $j$ , the  $g_j$ 's must vanish at this point, proving that  $(a_1, \dots, a_n) \in W$ . This shows that  $\mathbf{V}(f_i g_j) \subset V \cup W$ .  $\square$

This lemma implies that finite intersections and unions of affine varieties are again affine varieties. It turns out that we have already seen examples of unions and intersections. Concerning unions, consider the union of the  $(x, y)$ -plane and the  $z$ -axis in affine 3-space. By the above formula, we have

$$\mathbf{V}(z) \cup \mathbf{V}(x, y) = \mathbf{V}(zx, zy).$$

This, of course, is one of the examples discussed earlier in the section. As for intersections, notice that the twisted cubic was given as the intersection of two surfaces.

The examples given in this section lead to some interesting questions concerning affine varieties. Suppose that we have  $f_1, \dots, f_s \in k[x_1, \dots, x_n]$ . Then:

- (Consistency) Can we determine if  $\mathbf{V}(f_1, \dots, f_s) \neq \emptyset$ , i.e., do the equations  $f_1 = \dots = f_s = 0$  have a common solution?
- (Finiteness) Can we determine if  $\mathbf{V}(f_1, \dots, f_s)$  is finite, and if so, can we find all of the solutions explicitly?
- (Dimension) Can we determine the “dimension” of  $\mathbf{V}(f_1, \dots, f_s)$ ?

The answer to these questions is yes, although care must be taken in choosing the field  $k$  that we work over. The hardest is the one concerning dimension, for it involves some sophisticated concepts. Nevertheless, we will give complete solutions to all three problems.

### EXERCISES FOR §2

1. Sketch the following affine varieties in  $\mathbb{R}^2$ :

- $\mathbf{V}(x^2 + 4y^2 + 2x - 16y + 1)$ .
- $\mathbf{V}(x^2 - y^2)$ .
- $\mathbf{V}(2x + y - 1, 3x - y + 2)$ .

In each case, does the variety have the dimension you would intuitively expect it to have?

- In  $\mathbb{R}^2$ , sketch  $\mathbf{V}(y^2 - x(x - 1)(x - 2))$ . Hint: For which  $x$ 's is it possible to solve for  $y$ ? How many  $y$ 's correspond to each  $x$ ? What symmetry does the curve have?
- In the plane  $\mathbb{R}^2$ , draw a picture to illustrate

$$\mathbf{V}(x^2 + y^2 - 4) \cap \mathbf{V}(xy - 1) = \mathbf{V}(x^2 + y^2 - 4, xy - 1),$$

and determine the points of intersection. Note that this is a special case of Lemma 2.

4. Sketch the following affine varieties in  $\mathbb{R}^3$ :

- $\mathbf{V}(x^2 + y^2 + z^2 - 1)$ .
- $\mathbf{V}(x^2 + y^2 - 1)$ .
- $\mathbf{V}(x + 2, y - 1.5, z)$ .
- $\mathbf{V}(xz^2 - xy)$ . Hint: Factor  $xz^2 - xy$ .
- $\mathbf{V}(x^4 - zx, x^3 - yx)$ .
- $\mathbf{V}(x^2 + y^2 + z^2 - 1, x^2 + y^2 + (z - 1)^2 - 1)$ .

In each case, does the variety have the dimension you would intuitively expect it to have?

- Use the proof of Lemma 2 to sketch  $\mathbf{V}((x - 2)(x^2 - y), y(x^2 - y), (z + 1)(x^2 - y))$  in  $\mathbb{R}^3$ . Hint: This is the union of which two varieties?
- Let us show that all finite subsets of  $k^n$  are affine varieties.
  - Prove that a single point  $(a_1, \dots, a_n) \in k^n$  is an affine variety.
  - Prove that every finite subset of  $k^n$  is an affine variety. Hint: Lemma 2 will be useful.
- One of the prettiest examples from polar coordinates is the four-leaved rose

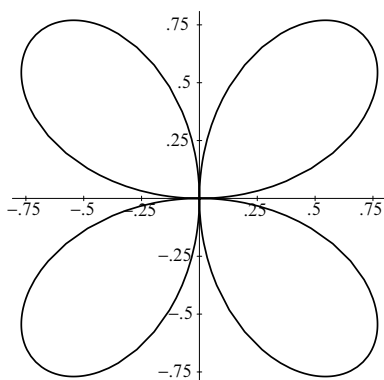

This curve is defined by the polar equation  $r = \sin(2\theta)$ . We will show that this curve is an affine variety.

- a. Using  $r^2 = x^2 + y^2$ ,  $x = r \cos(\theta)$  and  $y = r \sin(\theta)$ , show that the four-leaved rose is contained in the affine variety  $\mathbf{V}((x^2 + y^2)^3 - 4x^2y^2)$ . Hint: Use an identity for  $\sin(2\theta)$ .
- b. Now argue carefully that  $\mathbf{V}((x^2 + y^2)^3 - 4x^2y^2)$  is contained in the four-leaved rose. This is trickier than it seems since  $r$  can be negative in  $r = \sin(2\theta)$ .

Combining parts a and b, we have proved that the four-leaved rose is the affine variety  $\mathbf{V}((x^2 + y^2)^3 - 4x^2y^2)$ .

8. It can take some work to show that something is *not* an affine variety. For example, consider the set

$$X = \{(x, x) : x \in \mathbb{R}, x \neq 1\} \subset \mathbb{R}^2,$$

which is the straight line  $x = y$  with the point  $(1, 1)$  removed. To show that  $X$  is not an affine variety, suppose that  $X = \mathbf{V}(f_1, \dots, f_s)$ . Then each  $f_i$  vanishes on  $X$ , and if we can show that  $f_i$  also vanishes at  $(1, 1)$ , we will get the desired contradiction. Thus, here is what you are to prove: if  $f \in \mathbb{R}[x, y]$  vanishes on  $X$ , then  $f(1, 1) = 0$ . Hint: Let  $g(t) = f(t, t)$ , which is a polynomial  $\mathbb{R}[t]$ . Now apply the proof of Proposition 5 of §1.

9. Let  $R = \{(x, y) \in \mathbb{R}^2 : y > 0\}$  be the upper half plane. Prove that  $R$  is not an affine variety.
10. Let  $\mathbb{Z}^n \subset \mathbb{C}^n$  consist of those points with integer coordinates. Prove that  $\mathbb{Z}^n$  is not an affine variety. Hint: See Exercise 6 from §1.
11. So far, we have discussed varieties over  $\mathbb{R}$  or  $\mathbb{C}$ . It is also possible to consider varieties over the field  $\mathbb{Q}$ , although the questions here tend to be *much* harder. For example, let  $n$  be a positive integer, and consider the variety  $F_n \subset \mathbb{Q}^2$  defined by

$$x^n + y^n = 1.$$

Notice that there are some obvious solutions when  $x$  or  $y$  is zero. We call these *trivial solutions*. An interesting question is whether or not there are any nontrivial solutions.

- a. Show that  $F_n$  has two trivial solutions if  $n$  is odd and four trivial solutions if  $n$  is even.
- b. Show that  $F_n$  has a nontrivial solution for some  $n \geq 3$  if and only if Fermat's Last Theorem were false.

*Fermat's Last Theorem* states that, for  $n \geq 3$ , the equation

$$x^n + y^n = z^n$$

has no solutions where  $x$ ,  $y$ , and  $z$  are nonzero integers. The general case of this conjecture was proved by Andrew Wiles in 1994 using some very sophisticated number theory. The proof is *extremely* difficult.

12. Find a Lagrange multipliers problem in a calculus book and write down the corresponding system of equations. Be sure to use an example where one wants to find the minimum or maximum of a polynomial function subject to a polynomial constraint. This way the equations define an affine variety, and try to find a problem that leads to complicated equations. Later we will use Groebner basis methods to solve these equations.
13. Consider a robot arm in  $\mathbb{R}^2$  that consists of three arms of lengths 3, 2, and 1, respectively. The arm of length 3 is anchored at the origin, the arm of length 2 is attached to the free end of the arm of length 3, and the arm of length 1 is attached to the free end of the arm of length 2. The "hand" of the robot arm is attached to the end of the arm of length 1.
- a. Draw a picture of the robot arm.
- b. How many variables does it take to determine the "state" of the robot arm?
- c. Give the equations for the variety of possible states.
- d. Using the intuitive notion of dimension discussed in this section, guess what the dimension of the variety of states should be.

14. This exercise will study the possible “hand” positions of the robot arm described in Exercise 13.
- If  $(u, v)$  is the position of the hand, explain why  $u^2 + v^2 \leq 36$ .
  - Suppose we “lock” the joint between the length 3 and length 2 arms to form a straight angle, but allow the other joint to move freely. Draw a picture to show that in these configurations,  $(u, v)$  can be *any* point of the annulus  $16 \leq u^2 + v^2 \leq 36$ .
  - Draw a picture to show that  $(u, v)$  can be any point in the disk  $u^2 + v^2 \leq 36$ . Hint: These positions can be reached by putting the second joint in a fixed, special position.
15. In Lemma 2, we showed that if  $V$  and  $W$  are affine varieties, then so are their union  $V \cup W$  and intersection  $V \cap W$ . In this exercise we will study how other set-theoretic operations affect affine varieties.
- Prove that finite unions and intersections of affine varieties are again affine varieties. Hint: Induction.
  - Give an example to show that an infinite union of affine varieties need not be an affine variety. Hint: By Exercises 8–10, we know some subsets of  $k^n$  that are not affine varieties. Surprisingly, an infinite intersection of affine varieties is still an affine variety. This is a consequence of the Hilbert Basis Theorem, which will be discussed in Chapters 2 and 4.
  - Give an example to show that the set-theoretic difference  $V - W$  of two affine varieties need not be an affine variety.
  - Let  $V \subset k^n$  and  $W \subset k^m$  be two affine varieties, and let

$$V \times W = \{(x_1, \dots, x_n, y_1, \dots, y_m) \in k^{n+m} : \\ (x_1, \dots, x_n) \in V, (y_1, \dots, y_m) \in W\}$$

be their cartesian product. Prove that  $V \times W$  is an affine variety in  $k^{n+m}$ . Hint: If  $V$  is defined by  $f_1, \dots, f_s \in k[x_1, \dots, x_n]$ , then we can regard  $f_1, \dots, f_s$  as polynomials in  $k[x_1, \dots, x_n, y_1, \dots, y_m]$ , and similarly for  $W$ . Show that this gives defining equations for the cartesian product.

### §3 Parametrizations of Affine Varieties

In this section, we will discuss the problem of describing the points of an affine variety  $V(f_1, \dots, f_s)$ . This reduces to asking whether there is a way to “write down” the solutions of the system of polynomial equations  $f_1 = \dots = f_s = 0$ . When there are finitely many solutions, the goal is simply to list them all. But what do we do when there are infinitely many? As we will see, this question leads to the notion of parametrizing an affine variety.

To get started, let us look at an example from linear algebra. Let the field be  $\mathbb{R}$ , and consider the system of equations

$$(1) \quad \begin{aligned} x + y + z &= 1, \\ x + 2y - z &= 3. \end{aligned}$$

Geometrically, this represents the line in  $\mathbb{R}^3$  which is the intersection of the planes  $x + y + z = 1$  and  $x + 2y - z = 3$ . It follows that there are infinitely many solutions. To describe the solutions, we use row operations on equations (1) to obtain the

equivalent equations

$$\begin{aligned}x + 3z &= -1, \\y - 2z &= 2.\end{aligned}$$

Letting  $z = t$ , where  $t$  is arbitrary, this implies that all solutions of (1) are given by

$$(2) \quad \begin{aligned}x &= -1 - 3t, \\y &= 2 + 2t, \\z &= t\end{aligned}$$

as  $t$  varies over  $\mathbb{R}$ . We call  $t$  a *parameter*, and (2) is, thus, a *parametrization* of the solutions of (1).

To see if the idea of parametrizing solutions can be applied to other affine varieties, let us look at the example of the unit circle

$$(3) \quad x^2 + y^2 = 1.$$

A common way to parametrize the circle is using trigonometric functions:

$$\begin{aligned}x &= \cos(t), \\y &= \sin(t).\end{aligned}$$

There is also a more algebraic way to parametrize this circle:

$$(4) \quad \begin{aligned}x &= \frac{1-t^2}{1+t^2}, \\y &= \frac{2t}{1+t^2}.\end{aligned}$$

You should check that the points defined by these equations lie on the circle (3). It is also interesting to note that this parametrization does not describe the whole circle: since  $x = \frac{1-t^2}{1+t^2}$  can never equal  $-1$ , the point  $(-1, 0)$  is not covered. At the end of the section, we will explain how this parametrization was obtained.

Notice that equations (4) involve quotients of polynomials. These are examples of *rational functions*, and before we can say what it means to parametrize a variety, we need to define the general notion of rational function.

**Definition 1.** Let  $k$  be a field. A **rational function** in  $t_1, \dots, t_m$  with coefficients in  $k$  is a quotient  $f/g$  of two polynomials  $f, g \in k[t_1, \dots, t_m]$ , where  $g$  is not the zero polynomial. Furthermore, two rational functions  $f/g$  and  $f'/g'$  are equal, provided that  $g'f = gf'$  in  $k[t_1, \dots, t_m]$ . Finally, the set of all rational functions in  $t_1, \dots, t_m$  with coefficients in  $k$  is denoted  $k(t_1, \dots, t_m)$ .

It is not difficult to show that addition and multiplication of rational functions are well defined and that  $k(t_1, \dots, t_m)$  is a field. We will assume these facts without proof.

Now suppose that we are given a variety  $V = \mathbf{V}(f_1, \dots, f_s) \subset k^n$ . Then a *rational parametric representation* of  $V$  consists of rational functions  $r_1, \dots, r_n \in k(t_1, \dots, t_m)$



such that the points given by

$$\begin{aligned}x_1 &= r_1(t_1, \dots, t_m), \\x_2 &= r_2(t_1, \dots, t_m), \\&\vdots \\x_n &= r_n(t_1, \dots, t_m)\end{aligned}$$

lie in  $V$ . We also require that  $V$  be the “smallest” variety containing these points. As the example of the circle shows, a parametrization may not cover all points of  $V$ . In Chapter 3, we will give a more precise definition of what we mean by “smallest.”

In many situations, we have a parametrization of a variety  $V$ , where  $r_1, \dots, r_n$  are polynomials rather than rational functions. This is what we call a *polynomial parametric representation* of  $V$ .

By contrast, the original defining equations  $f_1 = \dots = f_s = 0$  of  $V$  are called an *implicit representation* of  $V$ . In our previous examples, note that equations (1) and (3) are implicit representations of varieties, whereas (2) and (4) are parametric.

One of the main virtues of a parametric representation of a curve or surface is that it is easy to draw on a computer. Given the formulas for the parametrization, the computer evaluates them for various values of the parameters and then plots the resulting points. For example, in §2 we viewed the surface  $\mathbf{V}(x^2 - y^2z^2 + z^3)$ :

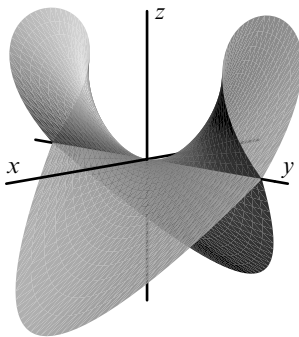

This picture was not plotted using the implicit representation  $x^2 - y^2z^2 + z^3 = 0$ . Rather, we used the parametric representation given by

$$(5) \quad \begin{aligned}x &= t(u^2 - t^2), \\y &= u, \\z &= u^2 - t^2.\end{aligned}$$

There are two parameters  $t$  and  $u$  since we are describing a surface, and the above picture was drawn using  $t, u$  in the range  $-1 \leq t, u \leq 1$ . In the exercises, we will derive this parametrization and check that it covers the entire surface  $\mathbf{V}(x^2 - y^2z^2 + z^3)$ .

At the same time, it is often useful to have an implicit representation of a variety. For example, suppose we want to know whether or not the point  $(1, 2, -1)$  is on the above surface. If all we had was the parametrization (5), then, to decide this question, we would need to solve the equations

$$(6) \quad \begin{aligned} 1 &= t(u^2 - t^2), \\ 2 &= u, \\ -1 &= u^2 - t^2 \end{aligned}$$

for  $t$  and  $u$ . On the other hand, if we have the implicit representation  $x^2 - y^2z^2 + z^3 = 0$ , then it is simply a matter of plugging into this equation. Since

$$1^2 - 2^2(-1)^2 + (-1)^3 = 1 - 4 - 1 = -4 \neq 0,$$

it follows that  $(1, 2, -1)$  is not on the surface [and, consequently, equations (6) have no solution].

The desirability of having both types of representations leads to the following two questions:

- (Parametrization) Does every affine variety have a rational parametric representation?
- (Implicitization) Given a parametric representation of an affine variety, can we find the defining equations (i.e., can we find an implicit representation)?

The answer to the first question is no. In fact, most affine varieties cannot be parametrized in the sense described here. Those that can are called *unirational*. In general, it is difficult to tell whether a given variety is unirational or not. The situation for the second question is much nicer. In Chapter 3, we will see that the answer is always yes: given a parametric representation, we can always find the defining equations.

Let us look at an example of how implicitization works. Consider the parametric representation

$$(7) \quad \begin{aligned} x &= 1 + t, \\ y &= 1 + t^2. \end{aligned}$$

This describes a curve in the plane, but at this point, we cannot be sure that it lies on an affine variety. To find the equation we are looking for, notice that we can solve the first equation for  $t$  to obtain

$$t = x - 1.$$

Substituting this into the second equation yields

$$y = 1 + (x - 1)^2 = x^2 - 2x + 2.$$

Hence the parametric equations (7) describe the affine variety  $\mathbf{V}(y - x^2 + 2x - 2)$ .

In the above example, notice that the basic strategy was to eliminate the variable  $t$  so that we were left with an equation involving only  $x$  and  $y$ . This illustrates the

role played by *elimination theory*, which will be studied in much greater detail in Chapter 3.

We will next discuss two examples of how geometry can be used to parametrize varieties. Let us start with the unit circle  $x^2 + y^2 = 1$ , which was parametrized in (4) via

$$x = \frac{1 - t^2}{1 + t^2},$$

$$y = \frac{2t}{1 + t^2}.$$

To see where this parametrization comes from, notice that each nonvertical line through  $(-1, 0)$  will intersect the circle in a unique point  $(x, y)$ :

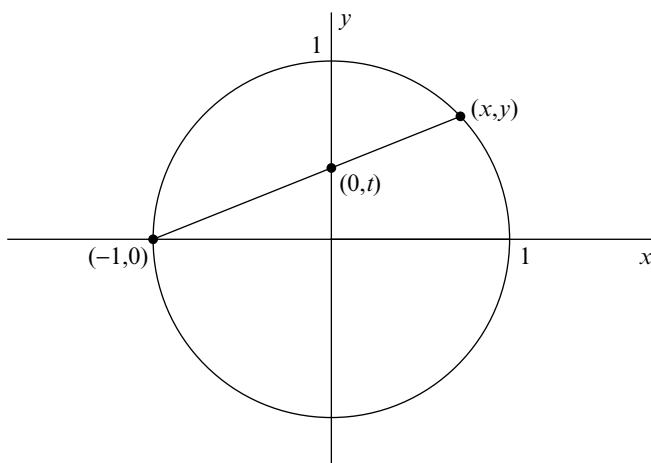

Each nonvertical line also meets the  $y$ -axis, and this is the point  $(0, t)$  in the above picture.

This gives us a geometric parametrization of the circle: given  $t$ , draw the line connecting  $(-1, 0)$  to  $(0, t)$ , and let  $(x, y)$  be the point where the line meets  $x^2 + y^2 = 1$ . Notice that the previous sentence really gives a parametrization: as  $t$  runs from  $-\infty$  to  $\infty$  on the vertical axis, the corresponding point  $(x, y)$  traverses all of the circle except for the point  $(-1, 0)$ .

It remains to find explicit formulas for  $x$  and  $y$  in terms of  $t$ . To do this, consider the *slope* of the line in the above picture. We can compute the slope in two ways, using either the points  $(-1, 0)$  and  $(0, t)$ , or the points  $(-1, 0)$  and  $(x, y)$ . This gives us the equation

$$\frac{t - 0}{0 - (-1)} = \frac{y - 0}{x - (-1)},$$

which simplifies to become

$$t = \frac{y}{x+1}.$$

Thus,  $y = t(x+1)$ . If we substitute this into  $x^2 + y^2 = 1$ , we get

$$x^2 + t^2(x+1)^2 = 1,$$

which gives the quadratic equation

$$(8) \quad (1+t^2)x^2 + 2t^2x + t^2 - 1 = 0.$$

This equation gives the  $x$ -coordinates of where the line meets the circle, and it is quadratic since there are two points of intersection. One of the points is  $-1$ , so that  $x+1$  is a factor of (8). It is now easy to find the other factor, and we can rewrite (8) as

$$(x+1)((1+t^2)x - (1-t^2)) = 0.$$

Since the  $x$ -coordinate we want is given by the second factor, we obtain

$$x = \frac{1-t^2}{1+t^2}.$$

Furthermore,  $y = t(x+1)$  easily leads to

$$y = \frac{2t}{1+t^2}$$

(you should check this), and we have now derived the parametrization given earlier. Note how the geometry tells us exactly what portion of the circle is covered.

For our second example, let us consider the twisted cubic  $\mathbf{V}(y-x^2, z-x^3)$  from §2. This is a curve in 3-dimensional space, and by looking at the tangent lines to the curve, we will get an interesting surface. The idea is as follows. Given one point on the curve, we can draw the tangent line at that point:

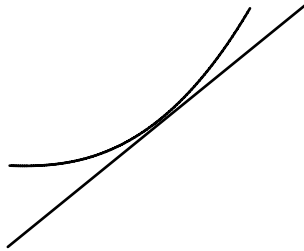

Now imagine taking the tangent lines for *all* points on the twisted cubic. This gives us the following surface:

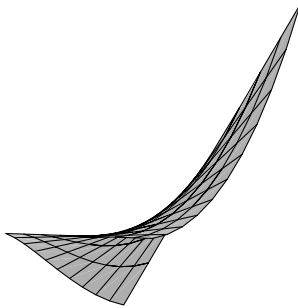

This picture shows several of the tangent lines. The above surface is called the *tangent surface* of the twisted cubic.

To convert this geometric description into something more algebraic, notice that setting  $x = t$  in  $y - x^2 = z - x^3 = 0$  gives us a parametrization

$$\begin{aligned}x &= t, \\y &= t^2, \\z &= t^3\end{aligned}$$

of the twisted cubic. We will write this as  $\mathbf{r}(t) = (t, t^2, t^3)$ . Now fix a particular value of  $t$ , which gives us a point on the curve. From calculus, we know that the tangent vector to the curve at the point given by  $\mathbf{r}(t)$  is  $\mathbf{r}'(t) = (1, 2t, 3t^2)$ . It follows that the tangent line is parametrized by

$$\mathbf{r}(t) + u\mathbf{r}'(t) = (t, t^2, t^3) + u(1, 2t, 3t^2) = (t + u, t^2 + 2tu, t^3 + 3t^2u),$$

where  $u$  is a parameter that moves along the tangent line. If we now allow  $t$  to vary, then we can parametrize the entire tangent surface by

$$\begin{aligned}x &= t + u, \\y &= t^2 + 2tu, \\z &= t^3 + 3t^2u.\end{aligned}$$

The parameters  $t$  and  $u$  have the following interpretations:  $t$  tells where we are on the curve, and  $u$  tells where we are on the tangent line. This parametrization was used to draw the picture of the tangent surface presented earlier.

A final question concerns the implicit representation of the tangent surface: how do we find its defining equation? This is a special case of the implicitization problem mentioned earlier and is equivalent to eliminating  $t$  and  $u$  from the above parametric equations. In Chapters 2 and 3, we will see that there is an algorithm for doing this, and, in particular, we will prove that the tangent surface to the twisted cubic is defined by the equation

$$-4x^3z + 3x^2y^2 - 4y^3 + 6xyz - z^2 = 0.$$

We will end this section with an example from Computer Aided Geometric Design (CAGD). When creating complex shapes like automobile hoods or airplane wings, design engineers need curves and surfaces that are varied in shape, easy to describe, and quick to draw. Parametric equations involving polynomial and rational functions satisfy these requirements; there is a large body of literature on this topic.

For simplicity, let us suppose that a design engineer wants to describe a curve in the plane. Complicated curves are usually created by joining together simpler pieces, and for the pieces to join smoothly, the tangent directions must match up at the endpoints. Thus, for each piece, the designer needs to control the following geometric data:

- the starting and ending points of the curve;
- the tangent directions at the starting and ending points.

The *Bézier cubic*, introduced by Renault auto designer P. Bézier, is especially well suited for this purpose. A Bézier cubic is given parametrically by the equations

$$(9) \quad \begin{aligned} x &= (1-t)^3x_0 + 3t(1-t)^2x_1 + 3t^2(1-t)x_2 + t^3x_3, \\ y &= (1-t)^3y_0 + 3t(1-t)^2y_1 + 3t^2(1-t)y_2 + t^3y_3 \end{aligned}$$

for  $0 \leq t \leq 1$ , where  $x_0, y_0, x_1, y_1, x_2, y_2, x_3, y_3$  are constants specified by the design engineer. We need to see how these constants correspond to the above geometric data.

If we evaluate the above formulas at  $t = 0$  and  $t = 1$ , then we obtain

$$\begin{aligned} (x(0), y(0)) &= (x_0, y_0), \\ (x(1), y(1)) &= (x_3, y_3). \end{aligned}$$

As  $t$  varies from 0 to 1, equations (9) describe a curve starting at  $(x_0, y_0)$  and ending at  $(x_3, y_3)$ . This gives us half of the needed data. We will next use calculus to find the tangent directions when  $t = 0$  and 1. We know that the tangent vector to (9) when  $t = 0$  is  $(x'(0), y'(0))$ . To calculate  $x'(0)$ , we differentiate the first line of (9) to obtain

$$x' = -3(1-t)^2x_0 + 3((1-t)^2 - 2t(1-t))x_1 + 3(2t(1-t) - t^2)x_2 + 3t^2x_3.$$

Then substituting  $t = 0$  yields

$$x'(0) = -3x_0 + 3x_1 = 3(x_1 - x_0),$$

and from here, it is straightforward to show that

$$(10) \quad \begin{aligned} (x'(0), y'(0)) &= 3(x_1 - x_0, y_1 - y_0), \\ (x'(1), y'(1)) &= 3(x_3 - x_2, y_3 - y_2). \end{aligned}$$

Since  $(x_1 - x_0, y_1 - y_0) = (x_1, y_1) - (x_0, y_0)$ , it follows that  $(x'(0), y'(0))$  is three times the vector from  $(x_0, y_0)$  to  $(x_1, y_1)$ . Hence, by placing  $(x_1, y_1)$ , the designer can control the tangent direction at the beginning of the curve. In a similar way, the placement of  $(x_2, y_2)$  controls the tangent direction at the end of the curve.

The points  $(x_0, y_0)$ ,  $(x_1, y_1)$ ,  $(x_2, y_2)$  and  $(x_3, y_3)$  are called the *control points* of the Bézier cubic. They are usually labelled  $P_0$ ,  $P_1$ ,  $P_2$  and  $P_3$ , and the convex quadrilateral they determine is called the *control polygon*. Here is a picture of a Bézier curve together with its control polygon:

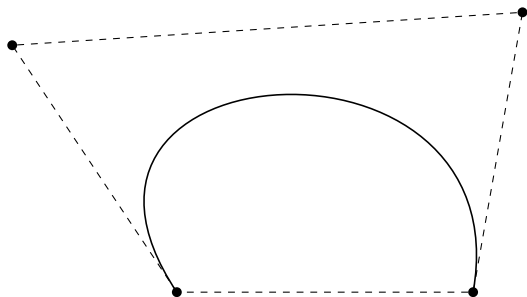

In the exercises, we will show that a Bézier cubic always lies inside its control polygon.

The data determining a Bézier cubic is thus easy to specify and has a strong geometric meaning. One issue not resolved so far is the *length* of the tangent vectors  $(x'(0), y'(0))$  and  $(x'(1), y'(1))$ . According to (10), it is possible to change the points  $(x_1, y_1)$  and  $(x_2, y_2)$  without changing the tangent directions. For example, if we keep the same directions as in the previous picture, but lengthen the tangent vectors, then we get the following curve:

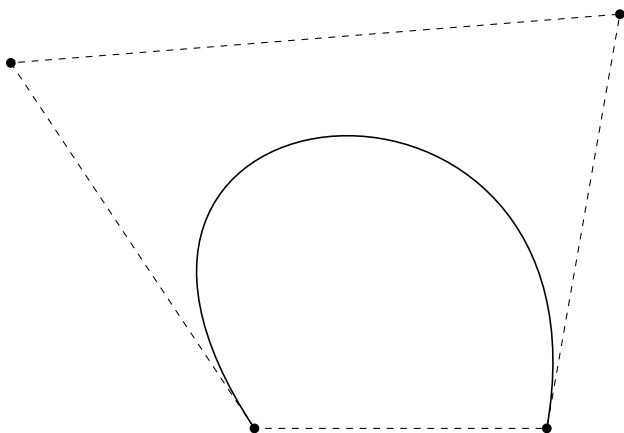

Thus, increasing the velocity at an endpoint makes the curve stay close to the tangent line for a longer distance. With practice and experience, a designer can become proficient in using Bézier cubics to create a wide variety of curves. It is interesting to note that the designer may never be aware of equations (9) that are used to describe the curve.

Besides CAGD, we should mention that Bézier cubics are also used in the page description language PostScript. The `curveto` command in PostScript has the coordinates of the control points as input and the Bézier cubic as output. This is how the above

Bézier cubics were drawn—each curve was specified by a single `curveto` instruction in a PostScript file.

**EXERCISES FOR §3**

1. Parametrize all solutions of the linear equations

$$\begin{aligned}x + 2y - 2z + w &= -1, \\x + y + z - w &= 2.\end{aligned}$$

2. Use a trigonometric identity to show that

$$\begin{aligned}x &= \cos(t), \\y &= \cos(2t)\end{aligned}$$

parametrizes a portion of a parabola. Indicate exactly what portion of the parabola is covered.

3. Given  $f \in k[x]$ , find a parametrization of  $\mathbf{V}(y - f(x))$ .  
4. Consider the parametric representation

$$\begin{aligned}x &= \frac{t}{1+t}, \\y &= 1 - \frac{1}{t^2}.\end{aligned}$$

- a. Find the equation of the affine variety determined by the above parametric equations.  
b. Show that the above equations parametrize all points of the variety found in part a except for the point  $(1,1)$ .  
5. This problem will be concerned with the hyperbola  $x^2 - y^2 = 1$ .

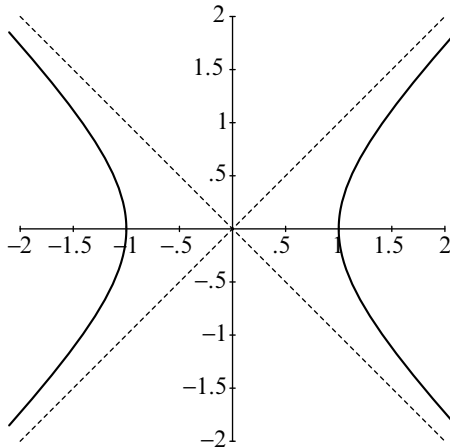

- a. Just as trigonometric functions are used to parametrize the circle, hyperbolic functions are used to parametrize the hyperbola. Show that the point

$$\begin{aligned}x &= \cosh(t), \\y &= \sinh(t)\end{aligned}$$

always lies on  $x^2 - y^2 = 1$ . What portion of the hyperbola is covered?



- b. Show that a straight line meets a hyperbola in 0, 1, or 2 points, and illustrate your answer with a picture. Hint: Consider the cases  $x = a$  and  $y = mx + b$  separately.
- c. Adapt the argument given at the end of the section to derive a parametrization of the hyperbola. Hint: Consider nonvertical lines through the point  $(-1, 0)$  on the hyperbola.
- d. The parametrization you found in part c is undefined for two values of  $t$ . Explain how this relates to the asymptotes of the hyperbola.
6. The goal of this problem is to show that the sphere  $x^2 + y^2 + z^2 = 1$  in 3-dimensional space can be parametrized by

$$\begin{aligned}x &= \frac{2u}{u^2 + v^2 + 1}, \\y &= \frac{2v}{u^2 + v^2 + 1}, \\z &= \frac{u^2 + v^2 - 1}{u^2 + v^2 + 1}.\end{aligned}$$

The idea is to adapt the argument given at the end of the section to 3-dimensional space.

- a. Given a point  $(u, v, 0)$  in the  $xy$ -plane, draw the line from this point to the “north pole”  $(0, 0, 1)$  of the sphere, and let  $(x, y, z)$  be the other point where the line meets the sphere. Draw a picture to illustrate this, and argue geometrically that mapping  $(u, v)$  to  $(x, y, z)$  gives a parametrization of the sphere minus the north pole.
- b. Show that the line connecting  $(0, 0, 1)$  to  $(u, v, 0)$  is parametrized by  $(tu, tv, 1-t)$ , where  $t$  is a parameter that moves along the line.
- c. Substitute  $x = tu$ ,  $y = tv$  and  $z = 1-t$  into the equation for the sphere  $x^2 + y^2 + z^2 = 1$ . Use this to derive the formulas given at the beginning of the problem.
7. Adapt the argument of the previous exercise to parametrize the “sphere”  $x_1^2 + \dots + x_n^2 = 1$  in  $n$ -dimensional affine space. Hint: There will be  $n - 1$  parameters.
8. Consider the curve defined by  $y^2 = cx^2 - x^3$ , where  $c$  is some constant. Here is a picture of the curve when  $c > 0$ :

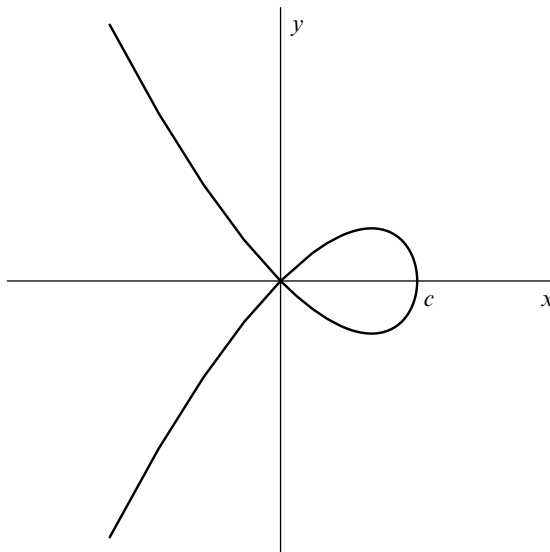

Our goal is to parametrize this curve.

- Show that a line will meet this curve at either 0, 1, 2, or 3 points. Illustrate your answer with a picture. Hint: Let the equation of the line be either  $x = a$  or  $y = mx + b$ .
- Show that a nonvertical line through the origin meets the curve at exactly one other point when  $m^2 \neq c$ . Draw a picture to illustrate this, and see if you can come up with an intuitive explanation as to why this happens.
- Now draw the vertical line  $x = 1$ . Given a point  $(1, t)$  on this line, draw the line connecting  $(1, t)$  to the origin. This will intersect the curve in a point  $(x, y)$ . Draw a picture to illustrate this, and argue geometrically that this gives a parametrization of the entire curve.
- Show that the geometric description from part (c) leads to the parametrization

$$\begin{aligned} x &= c - t^2, \\ y &= t(c - t^2). \end{aligned}$$

- The *strophoid* is a curve that was studied by various mathematicians, including Isaac Barrow (1630–1677), Jean Bernoulli (1667–1748), and Maria Agnesi (1718–1799). A trigonometric parametrization is given by

$$\begin{aligned} x &= a \sin(t), \\ y &= a \tan(t)(1 + \sin(t)) \end{aligned}$$

where  $a$  is a constant. If we let  $t$  vary in the range  $-4.5 \leq t \leq 1.5$ , we get the picture shown below.

- Find the equation in  $x$  and  $y$  that describes the strophoid. Hint: If you are sloppy, you will get the equation  $(a^2 - x^2)y^2 = x^2(a + x)^2$ . To see why this is not quite correct, see what happens when  $x = -a$ .
- Find an algebraic parametrization of the strophoid.

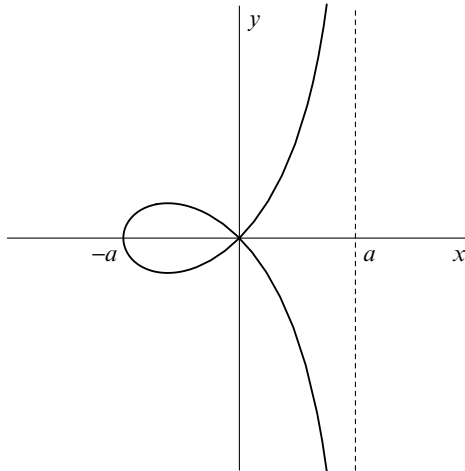

- Around 180 B.C., Diocles wrote the book *On Burning-Glasses*, and one of the curves he considered was the *cissoïd*. He used this curve to solve the problem of the duplication of the cube [see part (c) below]. The cissoïd has the equation  $y^2(a + x) = (a - x)^3$ , where  $a$  is a constant. This gives the following curve in the plane:

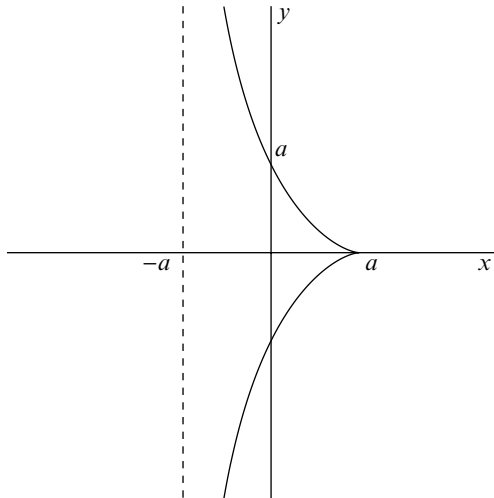

- a. Find an algebraic parametrization of the cissoid.
- b. Diocles described the cissoid using the following geometric construction. Given a circle of radius  $a$  (which we will take as centered at the origin), pick  $x$  between  $a$  and  $-a$ , and draw the line  $L$  connecting  $(a, 0)$  to the point  $P = (-x, \sqrt{a^2 - x^2})$  on the circle. This determines a point  $Q = (x, y)$  on  $L$ :

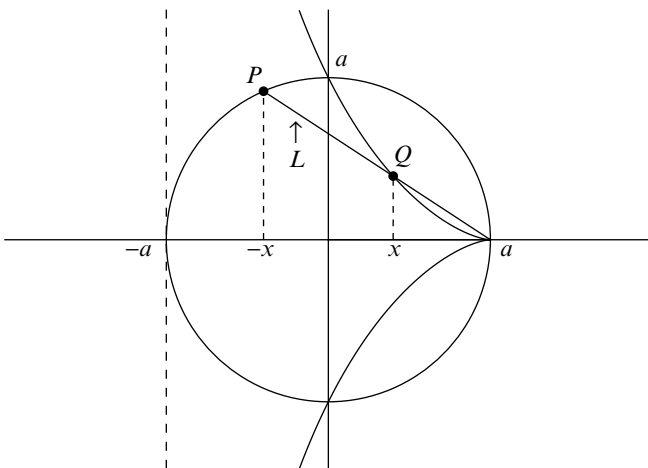

Prove that the cissoid is the locus of all such points  $Q$ .

- c. The duplication of the cube is the classical Greek problem of trying to construct  $\sqrt[3]{2}$  using ruler and compass. It is known that this is impossible given just a ruler and compass. Diocles showed that if in addition, you allow the use of the cissoid, then one can construct  $\sqrt[3]{2}$ . Here is how it works. Draw the line connecting  $(-a, 0)$  to  $(0, a/2)$ . This line will

meet the cissoid at a point  $(x, y)$ . Then prove that

$$2 = \left( \frac{a-x}{y} \right)^3,$$

which shows how to construct  $\sqrt[3]{2}$  using ruler, compass and cissoid.

11. In this problem, we will derive the parametrization

$$\begin{aligned}x &= t(u^2 - t^2), \\y &= u, \\z &= u^2 - t^2,\end{aligned}$$

of the surface  $x^2 - y^2z^2 + z^3 = 0$  considered in the text.

- a. Adapt the formulas in part (d) of Exercise 8 to show that the curve  $x^2 = cz^2 - z^3$  is parametrized by

$$\begin{aligned}z &= c - t^2, \\x &= t(c - t^2).\end{aligned}$$

- b. Now replace the  $c$  in part (a) by  $y^2$ , and explain how this leads to the above parametrization of  $x^2 - y^2z^2 + z^3 = 0$ .
- c. Explain why this parametrization covers the entire surface  $\mathbf{V}(x^2 - y^2z^2 + z^3)$ . Hint: See part (c) of Exercise 8.
12. Consider the variety  $V = \mathbf{V}(y - x^2, z - x^4) \subset \mathbb{R}^3$ .
- a. Draw a picture of  $V$ .
- b. Parametrize  $V$  in a way similar to what we did with the twisted cubic.
- c. Parametrize the tangent surface of  $V$ .
13. The general problem of finding the equation of a parametrized surface will be studied in Chapters 2 and 3. However, when the surface is a plane, methods from calculus or linear algebra can be used. For example, consider the plane in  $\mathbb{R}^3$  parametrized by

$$\begin{aligned}x &= 1 + u - v, \\y &= u + 2v, \\z &= -1 - u + v.\end{aligned}$$

Find the equation of the plane determined this way. Hint: Let the equation of the plane be  $ax + by + cz = d$ . Then substitute in the above parametrization to obtain a system of equations for  $a, b, c, d$ . Another way to solve the problem would be to write the parametrization in vector form as  $(1, 0, -1) + u(1, 1, -1) + v(-1, 2, 1)$ . Then one can get a quick solution using the cross product.

14. This problem deals with convex sets and will be used in the next exercise to show that a Bézier cubic lies within its control polygon. A subset  $C \subset \mathbb{R}^2$  is *convex* if for all  $P, Q \in C$ , the line segment joining  $P$  to  $Q$  also lies in  $C$ .
- a. If  $P = \begin{pmatrix} x \\ y \end{pmatrix}$  and  $Q = \begin{pmatrix} z \\ w \end{pmatrix}$  lie in a convex set  $C$ , then show that

$$t \begin{pmatrix} x \\ y \end{pmatrix} + (1-t) \begin{pmatrix} z \\ w \end{pmatrix} \in C$$

when  $0 \leq t \leq 1$ .

- b. If  $P_i = \begin{pmatrix} x_i \\ y_i \end{pmatrix}$  lies in a convex set  $C$  for  $1 \leq i \leq n$ , then show that

$$\sum_{i=1}^n t_i \begin{pmatrix} x_i \\ y_i \end{pmatrix} \in C$$

wherever  $t_1, \dots, t_n$  are nonnegative numbers such that  $\sum_{i=1}^n t_i = 1$ . Hint: Use induction on  $n$ .

15. Let a Bézier cubic be given by

$$\begin{aligned} x &= (1-t)^3 x_0 + 3t(1-t)^2 x_1 + 3t^2(1-t)x_2 + t^3 x_3, \\ y &= (1-t)^3 y_0 + 3t(1-t)^2 y_1 + 3t^2(1-t)y_2 + t^3 y_3. \end{aligned}$$

- a. Show that the above equations can be written in vector form

$$\begin{pmatrix} x \\ y \end{pmatrix} = (1-t)^3 \begin{pmatrix} x_0 \\ y_0 \end{pmatrix} + 3t(1-t)^2 \begin{pmatrix} x_1 \\ y_1 \end{pmatrix} + 3t^2(1-t) \begin{pmatrix} x_2 \\ y_2 \end{pmatrix} + t^3 \begin{pmatrix} x_3 \\ y_3 \end{pmatrix}.$$

- b. Use the previous exercise to show that a Bézier cubic always lies inside its control polygon. Hint: In the above equations, what is the sum of the coefficients?

16. One disadvantage of Bézier cubics is that curves like circles and hyperbolas cannot be described exactly by cubics. In this exercise, we will discuss a method similar to example (4) for parametrizing conic sections. Our treatment is based on BALL (1987).

A *conic section* is a curve in the plane defined by a second degree equation of the form  $ax^2 + bxy + cy^2 + dx + ey + f = 0$ . Conic sections include the familiar examples of circles, ellipses, parabolas, and hyperbolas. Now consider the curve parametrized by

$$\begin{aligned} x &= \frac{(1-t)^2 x_1 + 2t(1-t)w x_2 + t^2 x_3}{(1-t)^2 + 2t(1-t)w + t^2}, \\ y &= \frac{(1-t)^2 y_1 + 2t(1-t)w y_2 + t^2 y_3}{(1-t)^2 + 2t(1-t)w + t^2} \end{aligned}$$

for  $0 \leq t \leq 1$ . The constants  $w, x_1, y_1, x_2, y_2, x_3, y_3$  are specified by the design engineer, and we will assume that  $w \geq 0$ . In Chapter 3, we will show that these equations parametrize a conic section. The goal of this exercise is to give a geometric interpretation for the quantities  $w, x_1, y_1, x_2, y_2, x_3, y_3$ .

- Show that our assumption  $w \geq 0$  implies that the denominator in the above formulas never vanishes.
- Evaluate the above formulas at  $t = 0$  and  $t = 1$ . This should tell you what  $x_1, y_1, x_3, y_3$  mean.
- Now compute  $(x'(0), y'(0))$  and  $(x'(1), y'(1))$ . Use this to show that  $(x_2, y_2)$  is the intersection of the tangent lines at the start and end of the curve. Explain why  $(x_1, y_1), (x_2, y_2),$  and  $(x_3, y_3)$  are called the *control points* of the curve.
- Define the *control polygon* (it is actually a triangle in this case), and prove that the curve defined by the above equations always lies in its control polygon. Hint: Adapt the argument of the previous exercise. This gives the following picture:

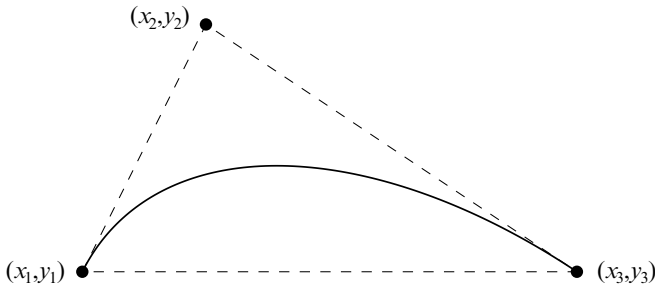

It remains to explain the constant  $w$ , which is called the *shape factor*. A hint should come from the answer to part (c), for note that  $w$  appears in the formulas for the tangent vectors when  $t = 0$  and  $1$ . So  $w$  somehow controls the “velocity,” and a larger  $w$  should force the curve closer to  $(x_2, y_2)$ . In the last two parts of the problem, we will determine exactly what  $w$  does.

e. Prove that

$$\begin{pmatrix} x \\ y \end{pmatrix} \left( \frac{1}{2} \right) = \frac{1}{1+w} \begin{pmatrix} \frac{1}{2}(x_1) \\ \frac{1}{2}(y_1) \end{pmatrix} + \frac{1}{1+w} \begin{pmatrix} \frac{1}{2}(x_3) \\ \frac{1}{2}(y_3) \end{pmatrix} + \frac{w}{1+w} \begin{pmatrix} x_2 \\ y_2 \end{pmatrix}.$$

Use this formula to show that  $\left(x\left(\frac{1}{2}\right), y\left(\frac{1}{2}\right)\right)$  lies on the line segment connecting  $(x_2, y_2)$  to the midpoint of the line between  $(x_1, y_1)$  and  $(x_3, y_3)$ .

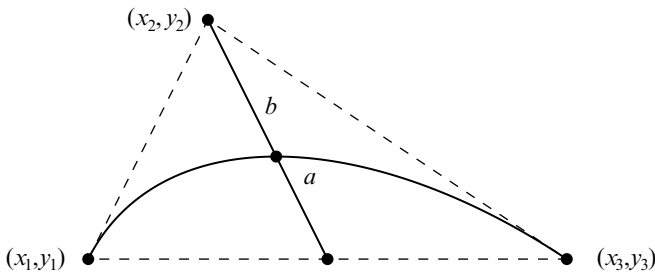

f. Notice that  $\left(x\left(\frac{1}{2}\right), y\left(\frac{1}{2}\right)\right)$  divides this line segment into two pieces, say of lengths  $a$  and  $b$  as indicated in the above picture. Then prove that

$$w = \frac{a}{b},$$

so that  $w$  tells us exactly where the curve crosses this line segment. Hint: Use the distance formula.

17. Use the formulas of the previous exercise to parametrize the arc of the circle  $x^2 + y^2 = 1$  from  $(1, 0)$  to  $(0, 1)$ . Hint: Use part (f) of Exercise 16 to show that  $w = 1/\sqrt{2}$ .

## §4 Ideals

We next define the basic algebraic object of the book.

**Definition 1.** A subset  $I \subset k[x_1, \dots, x_n]$  is an **ideal** if it satisfies:

- (i)  $0 \in I$ .
- (ii) If  $f, g \in I$ , then  $f + g \in I$ .
- (iii) If  $f \in I$  and  $h \in k[x_1, \dots, x_n]$ , then  $hf \in I$ .

The goal of this section is to introduce the reader to some naturally occurring ideals and to see how ideals relate to affine varieties. The real importance of ideals is that they will give us a language for computing with affine varieties.

The first natural example of an ideal is the ideal generated by a finite number of polynomials.

**Definition 2.** Let  $f_1, \dots, f_s$  be polynomials in  $k[x_1, \dots, x_n]$ . Then we set

$$\langle f_1, \dots, f_s \rangle = \left\{ \sum_{i=1}^s h_i f_i : h_1, \dots, h_s \in k[x_1, \dots, x_n] \right\}.$$

The crucial fact is that  $\langle f_1, \dots, f_s \rangle$  is an ideal.

**Lemma 3.** If  $f_1, \dots, f_s \in k[x_1, \dots, x_n]$ , then  $\langle f_1, \dots, f_s \rangle$  is an ideal of  $k[x_1, \dots, x_n]$ . We will call  $\langle f_1, \dots, f_s \rangle$  the **ideal generated by**  $f_1, \dots, f_s$ .

**Proof.** First,  $0 \in \langle f_1, \dots, f_s \rangle$  since  $0 = \sum_{i=1}^s 0 \cdot f_i$ . Next, suppose that  $f = \sum_{i=1}^s p_i f_i$  and  $g = \sum_{i=1}^s q_i f_i$ , and let  $h \in k[x_1, \dots, x_n]$ . Then the equations

$$\begin{aligned} f + g &= \sum_{i=1}^s (p_i + q_i) f_i, \\ hf &= \sum_{i=1}^s (hp_i) f_i \end{aligned}$$

complete the proof that  $\langle f_1, \dots, f_s \rangle$  is an ideal. □

The ideal  $\langle f_1, \dots, f_s \rangle$  has a nice interpretation in terms of polynomial equations. Given  $f_1, \dots, f_s \in k[x_1, \dots, x_n]$ , we get the system of equations

$$\begin{aligned} f_1 &= 0, \\ &\vdots \\ f_s &= 0. \end{aligned}$$

From these equations, one can derive others using algebra. For example, if we multiply the first equation by  $h_1 \in k[x_1, \dots, x_n]$ , the second by  $h_2 \in k[x_1, \dots, x_n]$ , etc., and then add the resulting equations, we obtain

$$h_1 f_1 + h_2 f_2 + \dots + h_s f_s = 0,$$

which is a consequence of our original system. Notice that the left-hand side of

this equation is exactly an element of the ideal  $\langle f_1, \dots, f_s \rangle$ . Thus, we can think of  $\langle f_1, \dots, f_s \rangle$  as consisting of all “polynomial consequences” of the equations  $f_1 = f_2 = \dots = f_s = 0$ .

To see what this means in practice, consider the example from §3 where we took

$$\begin{aligned}x &= 1 + t, \\y &= 1 + t^2\end{aligned}$$

and eliminated  $t$  to obtain

$$y = x^2 - 2x + 2$$

[see the discussion following equation (7) in §3]. Let us redo this example using the above ideas. We start by writing the equations as

$$(1) \quad \begin{aligned}x - 1 - t &= 0, \\y - 1 - t^2 &= 0.\end{aligned}$$

To cancel the  $t$  terms, we multiply the first equation by  $x - 1 + t$  and the second by  $-1$ :

$$\begin{aligned}(x - 1)^2 - t^2 &= 0, \\-y + 1 + t^2 &= 0,\end{aligned}$$

and then add to obtain

$$(x - 1)^2 - y + 1 = x^2 - 2x + 2 - y = 0.$$

In terms of the ideal generated by equations (1), we can write this as

$$\begin{aligned}x^2 - 2x + 2 - y &= (x - 1 + t)(x - 1 - t) + (-1)(y - 1 - t^2) \\&\in \langle x - 1 - t, y - 1 - t^2 \rangle.\end{aligned}$$

Similarly, any other “polynomial consequence” of (1) leads to an element of this ideal.

We say that an ideal  $I$  is *finitely generated* if there exist  $f_1, \dots, f_s \in k[x_1, \dots, x_n]$  such that  $I = \langle f_1, \dots, f_s \rangle$ , and we say that  $f_1, \dots, f_s$  are a *basis* of  $I$ . In Chapter 2, we will prove the amazing fact that *every* ideal of  $k[x_1, \dots, x_n]$  is finitely generated (this is known as the Hilbert Basis Theorem). Note that a given ideal may have many different bases. In Chapter 2, we will show that one can choose an especially useful type of basis, called a Groebner basis.

There is a nice analogy with linear algebra that can be made here. The definition of an ideal is similar to the definition of a subspace: both have to be closed under addition and multiplication, except that, for a subspace, we multiply by scalars, whereas for an ideal, we multiply by polynomials. Further, notice that the ideal generated by polynomials  $f_1, \dots, f_s$  is similar to the span of a finite number of vectors  $v_1, \dots, v_s$ . In each case, one takes linear combinations, using field coefficients for the span and polynomial coefficients for the ideal generated. Relations with linear algebra are explored further in Exercise 6.



Another indication of the role played by ideals is the following proposition, which shows that a variety depends only on the *ideal* generated by its defining equations.

**Proposition 4.** *If  $f_1, \dots, f_s$  and  $g_1, \dots, g_t$  are bases of the same ideal in  $k[x_1, \dots, x_n]$ , so that  $\langle f_1, \dots, f_s \rangle = \langle g_1, \dots, g_t \rangle$ , then we have  $\mathbf{V}(f_1, \dots, f_s) = \mathbf{V}(g_1, \dots, g_t)$ .*

**Proof.** The proof is very straightforward and is left as an exercise. □

As an example, consider the variety  $\mathbf{V}(2x^2 + 3y^2 - 11, x^2 - y^2 - 3)$ . It is easy to show that  $\langle 2x^2 + 3y^2 - 11, x^2 - y^2 - 3 \rangle = \langle x^2 - 4, y^2 - 1 \rangle$  (see Exercise 3), so that

$$\mathbf{V}(2x^2 + 3y^2 - 11, x^2 - y^2 - 3) = \mathbf{V}(x^2 - 4, y^2 - 1) = \{(\pm 2, \pm 1)\}$$

by the above proposition. Thus, by changing the basis of the ideal, we made it easier to determine the variety.

The ability to change the basis without affecting the variety is very important. Later in the book, this will lead to the observation that affine varieties are determined by *ideals*, not equations. (In fact, the correspondence between ideals and varieties is the main topic of Chapter 4.) From a more practical point of view, we will also see that Proposition 4, when combined with the Groebner bases mentioned above, provides a powerful tool for understanding affine varieties.

We will next discuss how affine varieties give rise to an interesting class of ideals. Suppose we have an affine variety  $V = \mathbf{V}(f_1, \dots, f_s) \subset k^n$  defined by  $f_1, \dots, f_s \in k[x_1, \dots, x_n]$ . We know that  $f_1, \dots, f_s$  vanish on  $V$ , but are these the only ones? Are there other polynomials that vanish on  $V$ ? For example, consider the twisted cubic studied in §2. This curve is defined by the vanishing of  $y - x^2$  and  $z - x^3$ . From the parametrization  $(t, t^2, t^3)$  discussed in §3, we see that  $z - xy$  and  $y^2 - xz$  are two more polynomials that vanish on the twisted cubic. Are there other such polynomials? How do we find them all?

To study this question, we will consider the set of *all* polynomials that vanish on a given variety.

**Definition 5.** *Let  $V \subset k^n$  be an affine variety. Then we set*

$$\mathbf{I}(V) = \{f \in k[x_1, \dots, x_n] : f(a_1, \dots, a_n) = 0 \text{ for all } (a_1, \dots, a_n) \in V\}.$$

The crucial observation is that  $\mathbf{I}(V)$  is an ideal.

**Lemma 6.** *If  $V \subset k^n$  is an affine variety, then  $\mathbf{I}(V) \subset k[x_1, \dots, x_n]$  is an ideal. We will call  $\mathbf{I}(V)$  the **ideal of  $V$** .*

**Proof.** It is obvious that  $0 \in \mathbf{I}(V)$  since the zero polynomial vanishes on all of  $k^n$ , and so, in particular it vanishes on  $V$ . Next, suppose that  $f, g \in \mathbf{I}(V)$  and  $h \in k[x_1, \dots, x_n]$ .

Let  $(a_1, \dots, a_n)$  be an arbitrary point of  $V$ . Then

$$\begin{aligned} f(a_1, \dots, a_n) + g(a_1, \dots, a_n) &= 0 + 0 = 0, \\ h(a_1, \dots, a_n)f(a_1, \dots, a_n) &= h(a_1, \dots, a_n) \cdot 0 = 0, \end{aligned}$$

and it follows that  $\mathbf{I}(V)$  is an ideal.  $\square$

For an example of the ideal of a variety, consider the variety  $\{(0, 0)\}$  consisting of the origin in  $k^2$ . Then its ideal  $\mathbf{I}(\{(0, 0)\})$  consists of all polynomials that vanish at the origin, and we claim that

$$\mathbf{I}(\{(0, 0)\}) = \langle x, y \rangle.$$

One direction of proof is trivial, for any polynomial of the form  $A(x, y)x + B(x, y)y$  obviously vanishes at the origin. Going the other way, suppose that  $f = \sum_{i,j} a_{ij}x^i y^j$  vanishes at the origin. Then  $a_{00} = f(0, 0) = 0$  and, consequently,

$$\begin{aligned} f &= a_{00} + \sum_{i,j \neq 0,0} a_{ij}x^i y^j \\ &= 0 + \left( \sum_{\substack{i,j \\ i>0}} a_{ij}x^{i-1}y^j \right) x + \left( \sum_{j>0} a_{0j}y^{j-1} \right) y \in \langle x, y \rangle. \end{aligned}$$

Our claim is now proved.

For another example, consider the case when  $V$  is all of  $k^n$ . Then  $\mathbf{I}(k^n)$  consists of polynomials that vanish everywhere, and, hence, by Proposition 5 of §1, we have

$$\mathbf{I}(k^n) = \{0\} \quad \text{when } k \text{ is infinite.}$$

(Here, “0” denotes the zero polynomial in  $k[x_1, \dots, x_n]$ .) Note that Proposition 5 of §1 is equivalent to the above statement. In the exercises, we will discuss what happens when  $k$  is a finite field.

For a more interesting example, consider the twisted cubic  $V = \mathbf{V}(y-x^2, z-x^3) \subset \mathbb{R}^3$ . We claim that

$$\mathbf{I}(V) = \langle y - x^2, z - x^3 \rangle.$$

To prove this, we will first show that given a polynomial  $f \in \mathbb{R}[x, y, z]$ , we can write  $f$  in the form

$$(2) \quad f = h_1(y - x^2) + h_2(z - x^3) + r,$$

where  $h_1, h_2 \in \mathbb{R}[x, y, z]$  and  $r$  is a polynomial in the variable  $x$  alone. First, consider the case when  $f$  is a monomial  $x^\alpha y^\beta z^\gamma$ . Then the binomial theorem tells us that

$$\begin{aligned} x^\alpha y^\beta z^\gamma &= x^\alpha (x^2 + (y - x^2))^\beta (x^3 + (z - x^3))^\gamma \\ &= x^\alpha (x^{2\beta} + \text{terms involving } y - x^2)(x^{3\gamma} + \text{terms involving } z - x^3), \end{aligned}$$

and multiplying this out shows that

$$x^\alpha y^\beta z^\gamma = h_1(y - x^2) + h_2(z - x^3) + x^{\alpha+2\beta+3\gamma}$$

for some polynomials  $h_1, h_2 \in \mathbb{R}[x, y, z]$ . Thus, (2) is true in this case. Since an arbitrary  $f \in \mathbb{R}[x, y, z]$  is an  $\mathbb{R}$ -linear combination of monomials, it follows that (2) holds in general.

We can now prove  $\mathbf{I}(V) = \langle y - x^2, z - x^3 \rangle$ . First, by the definition of the twisted cubic  $V$ , we have  $y - x^2, z - x^3 \in \mathbf{I}(V)$ , and since  $\mathbf{I}(V)$  is an ideal, it follows that  $h_1(y - x^2) + h_2(z - x^3) \in \mathbf{I}(V)$ . This proves that  $\langle y - x^2, z - x^3 \rangle \subset \mathbf{I}(V)$ . To prove the opposite inclusion, let  $f \in \mathbf{I}(V)$  and let

$$f = h_1(y - x^2) + h_2(z - x^3) + r$$

be the decomposition given by (2). To prove that  $r$  is zero, we will use the parametrization  $(t, t^2, t^3)$  of the twisted cubic. Since  $f$  vanishes on  $V$ , we obtain

$$0 = f(t, t^2, t^3) = 0 + 0 + r(t)$$

(recall that  $r$  is a polynomial in  $x$  alone). Since  $t$  can be any real number,  $r \in \mathbb{R}[x]$  must be the zero polynomial by Proposition 5 of §1. But  $r = 0$  shows that  $f$  has the desired form, and  $\mathbf{I}(V) = \langle y - x^2, z - x^3 \rangle$  is proved.

What we did in (2) is reminiscent of the division of polynomials, except that we are dividing by two polynomials instead of one. In fact, (2) is a special case of the generalized division algorithm to be studied in Chapter 2.

A nice corollary of the above example is that given a polynomial  $f \in \mathbb{R}[x, y, z]$ , we have  $f \in \langle y - x^2, z - x^3 \rangle$  if and only if  $f(t, t^2, t^3)$  is identically zero. This gives us an algorithm for deciding whether a polynomial lies in the ideal. However, this method is dependent on the parametrization  $(t, t^2, t^3)$ . Is there a way of deciding whether  $f \in \langle y - x^2, z - x^3 \rangle$  without using the parametrization? In Chapter 2, we will answer this question positively using Groebner bases and the generalized division algorithm.

The example of the twisted cubic is very suggestive. We started with the polynomials  $y - x^2$  and  $z - x^3$ , used them to define an affine variety, took all functions vanishing on the variety, and got back the ideal generated by the two polynomials. It is natural to wonder if this happens in general. So take  $f_1, \dots, f_s \in k[x_1, \dots, x_n]$ . This gives us

$$\begin{array}{ccccc} \text{polynomials} & & \text{variety} & & \text{ideal} \\ f_1, \dots, f_s & \rightarrow & \mathbf{V}(f_1, \dots, f_s) & \rightarrow & \mathbf{I}(\mathbf{V}(f_1, \dots, f_s)), \end{array}$$

and the natural question to ask is whether  $\mathbf{I}(\mathbf{V}(f_1, \dots, f_s)) = \langle f_1, \dots, f_s \rangle$ ? The answer, unfortunately, is not always yes. Here is the best answer we can give at this point.

**Lemma 7.** *If  $f_1, \dots, f_s \in k[x_1, \dots, x_n]$ , then  $\langle f_1, \dots, f_s \rangle \subset \mathbf{I}(\mathbf{V}(f_1, \dots, f_s))$ , although equality need not occur.*

**Proof.** Let  $f \in \langle f_1, \dots, f_s \rangle$ , which means that  $f = \sum_{i=1}^s h_i f_i$  for some polynomials  $h_1, \dots, h_s \in k[x_1, \dots, x_n]$ . Since  $f_1, \dots, f_s$  vanish on  $\mathbf{V}(f_1, \dots, f_s)$ , so must  $\sum_{i=1}^s h_i f_i$ . Thus,  $f$  vanishes on  $\mathbf{V}(f_1, \dots, f_s)$ , which proves  $f \in \mathbf{I}(\mathbf{V}(f_1, \dots, f_s))$ .

For the second part of the lemma, we need an example where  $\mathbf{I}(\mathbf{V}(f_1, \dots, f_s))$  is strictly larger than  $\langle f_1, \dots, f_s \rangle$ . We will show that the inclusion

$$\langle x^2, y^2 \rangle \subset \mathbf{I}(\mathbf{V}(x^2, y^2))$$

is not an equality. We first compute  $\mathbf{I}(\mathbf{V}(x^2, y^2))$ . The equations  $x^2 = y^2 = 0$  imply that  $\mathbf{V}(x^2, y^2) = \{(0, 0)\}$ . But an earlier example showed that the ideal of  $\{(0, 0)\}$  is  $\langle x, y \rangle$ , so that  $\mathbf{I}(\mathbf{V}(x^2, y^2)) = \langle x, y \rangle$ . To see that this is strictly larger than  $\langle x^2, y^2 \rangle$ , note that  $x \notin \langle x^2, y^2 \rangle$  since for polynomials of the form  $h_1(x, y)x^2 + h_2(x, y)y^2$ , every monomial has total degree at least two.  $\square$

For arbitrary fields, the relationship between  $\langle f_1, \dots, f_s \rangle$  and  $\mathbf{I}(\mathbf{V}(f_1, \dots, f_s))$  can be rather subtle (see the exercises for some examples). However, over an algebraically closed field like  $\mathbb{C}$ , there is a straightforward relation between these ideals. This will be explained when we prove the Nullstellensatz in Chapter 4.

Although for a general field,  $\mathbf{I}(\mathbf{V}(f_1, \dots, f_s))$  may not equal  $\langle f_1, \dots, f_s \rangle$ , the ideal of a variety always contains enough information to determine the variety uniquely.

**Proposition 8.** *Let  $V$  and  $W$  be affine varieties in  $k^n$ . Then:*

- (i)  $V \subset W$  if and only if  $\mathbf{I}(V) \supset \mathbf{I}(W)$ .
- (ii)  $V = W$  if and only if  $\mathbf{I}(V) = \mathbf{I}(W)$ .

**Proof.** We leave it as an exercise to show that (ii) is an immediate consequence of (i). To prove (i), first suppose that  $V \subset W$ . Then any polynomial vanishing on  $W$  must vanish on  $V$ , which proves  $\mathbf{I}(W) \subset \mathbf{I}(V)$ . Next, assume that  $\mathbf{I}(W) \subset \mathbf{I}(V)$ . We know that  $W$  is the variety defined by some polynomials  $g_1, \dots, g_t \in k[x_1, \dots, x_n]$ . Then  $g_1, \dots, g_t \in \mathbf{I}(W) \subset \mathbf{I}(V)$ , and hence the  $g_i$ 's vanish on  $V$ . Since  $W$  consists of *all* common zeros of the  $g_i$ 's, it follows that  $V \subset W$ .  $\square$

There is a rich relationship between ideals and affine varieties; the material presented so far is just the tip of the iceberg. We will explore this relation further in Chapter 4. In particular, we will see that theorems proved about ideals have strong geometric implications. For now, let us list three questions we can pose concerning ideals in  $k[x_1, \dots, x_n]$ :

- (Ideal Description) Can every ideal  $I \subset k[x_1, \dots, x_n]$  be written as  $\langle f_1, \dots, f_s \rangle$  for some  $f_1, \dots, f_s \in k[x_1, \dots, x_n]$ ?
- (Ideal Membership) If  $f_1, \dots, f_s \in k[x_1, \dots, x_n]$ , is there an algorithm to decide whether a given  $f \in k[x_1, \dots, x_n]$  lies in  $\langle f_1, \dots, f_s \rangle$ ?
- (Nullstellensatz) Given  $f_1, \dots, f_s \in k[x_1, \dots, x_n]$ , what is the exact relation between  $\langle f_1, \dots, f_s \rangle$  and  $\mathbf{I}(\mathbf{V}(f_1, \dots, f_s))$ ?

In the chapters that follow, we will solve these problems completely (and we will explain where the name Nullstellensatz comes from), although we will need to be careful about which field we are working over.

## EXERCISES FOR §4

1. Consider the equations

$$\begin{aligned}x^2 + y^2 - 1 &= 0, \\xy - 1 &= 0\end{aligned}$$

which describe the intersection of a circle and a hyperbola.

- Use algebra to eliminate  $y$  from the above equations.
  - Show how the polynomial found in part (a) lies in  $\langle x^2 + y^2 - 1, xy - 1 \rangle$ . Your answer should be similar to what we did in (1). Hint: Multiply the second equation by  $xy + 1$ .
2. Let  $I \subset k[x_1, \dots, x_n]$  be an ideal, and let  $f_1, \dots, f_s \in k[x_1, \dots, x_n]$ . Prove that the following statements are equivalent:
- $f_1, \dots, f_s \in I$ .
  - $\langle f_1, \dots, f_s \rangle \subset I$ .

This fact is useful when you want to show that one ideal is contained in another.

3. Use the previous exercise to prove the following equalities of ideals in  $\mathbb{Q}[x, y]$ :
- $\langle x + y, x - y \rangle = \langle x, y \rangle$ .
  - $\langle x + xy, y + xy, x^2, y^2 \rangle = \langle x, y \rangle$ .
  - $\langle 2x^2 + 3y^2 - 11, x^2 - y^2 - 3 \rangle = \langle x^2 - 4, y^2 - 1 \rangle$ .
- This illustrates that the same ideal can have many different bases and that different bases may have different numbers of elements.
4. Prove Proposition 4.
5. Show that  $\mathbf{V}(x + xy, y + xy, x^2, y^2) = \mathbf{V}(x, y)$ . Hint: See Exercise 3.
6. The word “basis” is used in various ways in mathematics. In this exercise, we will see that “a basis of an ideal,” as defined in this section, is quite different from “a basis of a subspace,” which is studied in linear algebra.

- First, consider the ideal  $I = \langle x \rangle \subset k[x]$ . As an ideal,  $I$  has a basis consisting of the one element  $x$ . But  $I$  can also be regarded as a subspace of  $k[x]$ , which is a vector space over  $k$ . Prove that any vector space basis of  $I$  over  $k$  is infinite. Hint: It suffices to find one basis that is infinite. Thus, allowing  $x$  to be multiplied by elements of  $k[x]$  instead of just  $k$  is what enables  $\langle x \rangle$  to have a finite basis.
- In linear algebra, a basis must span and be linearly independent over  $k$ , whereas for an ideal, a basis is concerned only with spanning—there is no mention of any sort of independence. The reason is that once we allow polynomial coefficients, no independence is possible. To see this, consider the ideal  $\langle x, y \rangle \subset k[x, y]$ . Show that zero can be written as a linear combination of  $y$  and  $x$  with nonzero polynomial coefficients.
- More generally, suppose that  $f_1, \dots, f_s$  is the basis of an ideal  $I \subset k[x_1, \dots, x_n]$ . If  $s \geq 2$  and  $f_i \neq 0$  for all  $i$ , then show that for any  $i$  and  $j$ , zero can be written as a linear combination of  $f_i$  and  $f_j$  with nonzero polynomial coefficients.
- A consequence of the lack of independence is that when we write an element  $f \in \langle f_1, \dots, f_s \rangle$  as  $f = \sum_{i=1}^s h_i f_i$ , the coefficients  $h_i$  are not unique. As an example, consider  $f = x^2 + xy + y^2 \in \langle x, y \rangle$ . Express  $f$  as a linear combination of  $x$  and  $y$  in two different ways. (Even though the  $h_i$ 's are not unique, one can measure their lack of uniqueness. This leads to the interesting topic of syzygies.)
- A basis  $f_1, \dots, f_s$  of an ideal  $I$  is said to be *minimal* if no proper subset of  $f_1, \dots, f_s$  is a basis of  $I$ . For example,  $x, x^2$  is a basis of an ideal, but not a minimal basis since  $x$  generates the same ideal. Unfortunately, an ideal can have minimal bases consisting

of different numbers of elements. To see this, show that  $x$  and  $x + x^2, x^2$  are minimal bases of the same ideal of  $k[x]$ . Explain how this contrasts with the situation in linear algebra.

7. Show that  $\mathbf{I}(\mathbf{V}(x^n, y^m)) = \langle x, y \rangle$  for any positive integers  $n$  and  $m$ .
8. The ideal  $\mathbf{I}(V)$  of a variety has a special property not shared by all ideals. Specifically, we define an ideal  $I$  to be *radical* if whenever a power  $f^m$  of a polynomial  $f$  is in  $I$ , then  $f$  itself is in  $I$ . More succinctly,  $I$  is radical when  $f \in I$  if and only if  $f^m \in I$  for some positive integer  $m$ .
  - a. Prove that  $\mathbf{I}(V)$  is always a radical ideal.
  - b. Prove that  $\langle x^2, y^2 \rangle$  is not a radical ideal. This implies that  $\langle x^2, y^2 \rangle \neq \mathbf{I}(V)$  for any variety  $V \subset k^2$ .

Radical ideals will play an important role in Chapter 4. In particular, the Nullstellensatz will imply that there is a one-to-one correspondence between varieties in  $\mathbb{C}^n$  and radical ideals in  $\mathbb{C}[x_1, \dots, x_n]$ .

9. Let  $V = \mathbf{V}(y - x^2, z - x^3)$  be the twisted cubic. In the text, we showed that  $\mathbf{I}(V) = \langle y - x^2, z - x^3 \rangle$ .
  - a. Use the parametrization of the twisted cubic to show that  $y^2 - xz \in \mathbf{I}(V)$ .
  - b. Use the argument given in the text to express  $y^2 - xz$  as a combination of  $y - x^2$  and  $z - x^3$ .
10. Use the argument given in the discussion of the twisted cubic to show that  $\mathbf{I}(\mathbf{V}(x - y)) = \langle x - y \rangle$ . Your argument should be valid for any infinite field  $k$ .
11. Let  $V \subset \mathbb{R}^3$  be the curve parametrized by  $(t, t^3, t^4)$ .
  - a. Prove that  $V$  is an affine variety.
  - b. Adapt the method used in the case of the twisted cubic to determine  $\mathbf{I}(V)$ .
12. Let  $V \subset \mathbb{R}^3$  be the curve parametrized by  $(t^2, t^3, t^4)$ .
  - a. Prove that  $V$  is an affine variety.
  - b. Determine  $\mathbf{I}(V)$ .

This problem is quite a bit more challenging than the previous one—figuring out the proper analogue of equation (2) is not easy. Once we study the division algorithm in Chapter 2, this exercise will become much easier.

13. In Exercise 2 of §1, we showed that  $x^2y + y^2x$  vanishes at all points of  $\mathbb{F}_2^2$ . More generally, let  $I \subset \mathbb{F}_2[x, y]$  be the ideal of all polynomials that vanish at all points of  $\mathbb{F}_2^2$ . The goal of this exercise is to show that  $I = \langle x^2 - x, y^2 - y \rangle$ .
  - a. Show that  $\langle x^2 - x, y^2 - y \rangle \subset I$ .
  - b. Show that every  $f \in \mathbb{F}_2[x, y]$  can be written as  $f = A(x^2 - x) + B(y^2 - y) + axy + bx + cy + d$ , where  $A, B \in \mathbb{F}_2[x, y]$  and  $a, b, c, d \in \mathbb{F}_2$ . Hint: Write  $f$  in the form  $\sum_i p_i(x)y^i$  and use the division algorithm (Proposition 2 of §5) to divide each  $p_i$  by  $x^2 - x$ . From this, you can write  $f = A(x^2 - x) + q_1(y)x + q_2(y)$ . Now divide  $q_1$  and  $q_2$  by  $y^2 - y$ . Again, this argument will become vastly simpler once we know the division algorithm from Chapter 2.
  - c. Show that  $axy + bx + cy + d \in I$  if and only if  $a = b = c = d = 0$ .
  - d. Using parts (b) and (c), complete the proof that  $I = \langle x^2 - x, y^2 - y \rangle$ .
  - e. Express  $x^2y + y^2x$  as a combination of  $x^2 - x$  and  $y^2 - y$ . Hint: Remember that  $2 = 1 + 1 = 0$  in  $\mathbb{F}_2$ .
14. This exercise is concerned with Proposition 8.
  - a. Prove that part (ii) of the proposition follows from part (i).
  - b. Prove the following corollary of the proposition: if  $V$  and  $W$  are affine varieties in  $k^n$ , then  $V \subsetneq W$  if and only if  $\mathbf{I}(V) \supsetneq \mathbf{I}(W)$ .

15. In the text, we defined  $\mathbf{I}(V)$  for a variety  $V \subset k^n$ . We can generalize this as follows: if  $S \subset k^n$  is any subset, then we set

$$\mathbf{I}(S) = \{f \in k[x_1, \dots, x_n] : f(a_1, \dots, a_n) = 0 \text{ for all } (a_1, \dots, a_n) \in S\}.$$

- Prove that  $\mathbf{I}(S)$  is an ideal.
- Let  $X = \{(a, a) \in \mathbb{R}^2 : a \neq 1\}$ . By Exercise 8 of §2, we know that  $X$  is not an affine variety. Determine  $\mathbf{I}(X)$ . Hint: What you proved in Exercise 8 of §2 will be useful. See also Exercise 10 of this section.
- Let  $\mathbb{Z}^n$  be the points of  $\mathbb{C}^n$  with integer coordinates. Determine  $\mathbf{I}(\mathbb{Z}^n)$ . Hint: See Exercise 6 of §1.

## §5 Polynomials of One Variable

In this section, we will discuss polynomials of one variable and study the *division algorithm* from high school algebra. This simple algorithm has some surprisingly deep consequences—for example, we will use it to determine the structure of ideals of  $k[x]$  and to explore the idea of a *greatest common divisor*. The theory developed will allow us to solve, in the special case of polynomials in  $k[x]$ , most of the problems raised in earlier sections. We will also begin to understand the important role played by algorithms.

By this point in their mathematics careers, most students have already seen a variety of algorithms, although the term “algorithm” may not have been used. Informally, an algorithm is a specific set of instructions for manipulating symbolic or numerical data. Examples are the differentiation formulas from calculus and the method of row reduction from linear algebra. An algorithm will have *inputs*, which are objects used by the algorithm, and *outputs*, which are the results of the algorithm. At each stage of execution, the algorithm must specify exactly what the next step will be.

When we are studying an algorithm, we will usually present it in “pseudocode,” which will make the formal structure easier to understand. Pseudocode is similar to the computer language Pascal, and a brief discussion is given in Appendix B. Another reason for using pseudocode is that it indicates how the algorithm could be programmed on a computer. We should also mention that most of the algorithms in this book are implemented in computer algebra systems such as AXIOM, Macsyma, Maple, Mathematica, and REDUCE. Appendix C has more details concerning these programs.

We begin by discussing the division algorithm for polynomials in  $k[x]$ . A crucial component of this algorithm is the notion of the “leading term” of a polynomial in one variable. The precise definition is as follows.

**Definition 1.** Given a nonzero polynomial  $f \in k[x]$ , let

$$f = a_0x^m + a_1x^{m-1} + \cdots + a_m,$$

where  $a_i \in k$  and  $a_0 \neq 0$  [thus,  $m = \deg(f)$ ]. Then we say that  $a_0x^m$  is the **leading term** of  $f$ , written  $\text{LT}(f) = a_0x^m$ .

For example, if  $f = 2x^3 - 4x + 3$ , then  $\text{LT}(f) = 2x^3$ . Notice also that if  $f$  and  $g$  are nonzero polynomials, then

$$(1) \quad \deg(f) \leq \deg(g) \iff \text{LT}(f) \text{ divides } \text{LT}(g).$$

We can now describe the division algorithm.

**Proposition 2 (The Division Algorithm).** *Let  $k$  be a field and let  $g$  be a nonzero polynomial in  $k[x]$ . Then every  $f \in k[x]$  can be written as*

$$f = qg + r,$$

where  $q, r \in k[x]$ , and either  $r = 0$  or  $\deg(r) < \deg(g)$ . Furthermore,  $q$  and  $r$  are unique, and there is an algorithm for finding  $q$  and  $r$ .

**Proof.** Here is the algorithm for finding  $q$  and  $r$ , presented in pseudocode:

```

Input:  $g, f$ 
Output:  $q, r$ 
 $q := 0; r := f$ 
WHILE  $r \neq 0$  AND  $\text{LT}(g)$  divides  $\text{LT}(r)$  DO
     $q := q + \text{LT}(r)/\text{LT}(g)$ 
     $r := r - (\text{LT}(r)/\text{LT}(g))g$ 

```

The WHILE . . . DO statement means doing the indented operations until the expression between the WHILE and DO becomes false. The statements  $q := \dots$  and  $r := \dots$  indicate that we are defining or redefining the values of  $q$  and  $r$ . Both  $q$  and  $r$  are *variables* in this algorithm—they change value at each step. We need to show that the algorithm terminates and that the final values of  $q$  and  $r$  have the required properties. (For a fuller discussion of pseudocode, see Appendix B.)

To see why this algorithm works, first note that  $f = qg + r$  holds for the initial values of  $q$  and  $r$ , and that whenever we redefine  $q$  and  $r$ , the equality  $f = qg + r$  remains true. This is because of the identity

$$f = qg + r = (q + \text{LT}(r)/\text{LT}(g))g + (r - (\text{LT}(r)/\text{LT}(g))g).$$

Next, note that the WHILE . . . DO statement terminates when “ $r \neq 0$  and  $\text{LT}(g)$  divides  $\text{LT}(r)$ ” is false, i.e., when either  $r = 0$  or  $\text{LT}(g)$  does not divide  $\text{LT}(r)$ . By (1), this last statement is equivalent to  $\deg(r) < \deg(g)$ . Thus, when the algorithm terminates, it produces  $q$  and  $r$  with the required properties.

We are not quite done; we still need to show that the algorithm terminates, i.e., that the expression between the WHILE and DO eventually becomes false (otherwise, we would be stuck in an infinite loop). The key observation is that  $r - (\text{LT}(r)/\text{LT}(g))g$  is either 0 or has smaller degree than  $r$ . To see why, suppose that

$$\begin{aligned} r &= a_0x^m + \dots + a_m, & \text{LT}(r) &= a_0x^m, \\ g &= b_0x^k + \dots + b_k, & \text{LT}(g) &= b_0x^k, \end{aligned}$$



and suppose that  $m \geq k$ . Then

$$r - (\text{LT}(r)/\text{LT}(g))g = (a_0x^m + \dots) - (a_0/b_0)x^{m-k}(b_0x^k + \dots),$$

and it follows that the degree of  $r$  must drop (or the whole expression may vanish). Since the degree is finite, it can drop at most finitely many times, which proves that the algorithm terminates.

To see how this algorithm corresponds to the process learned in high school, consider the following partially completed division:

$$\begin{array}{r} \frac{1}{2}x^2 \\ 2x + 1 \overline{) x^3 + 2x^2 + x + 1} \\ \underline{x^3 + \frac{1}{2}x^2} \phantom{+ 1} \\ \frac{3}{2}x^2 + x + 1. \end{array}$$

Here,  $f$  and  $g$  are given by  $f = x^3 + 2x^2 + x + 1$  and  $g = 2x + 1$ , and more importantly, the current (but *not* final) values of  $q$  and  $r$  are  $q = \frac{1}{2}x^2$  and  $r = \frac{3}{2}x^2 + x + 1$ . Now notice that the statements

$$\begin{aligned} q &:= q + \text{LT}(r)/\text{LT}(g), \\ r &:= r - (\text{LT}(r)/\text{LT}(g))g \end{aligned}$$

in the WHILE...DO loop correspond exactly to the next step in the above division.

The final step in proving the proposition is to show that  $q$  and  $r$  are unique. So suppose that  $f = qg + r = q'g + r'$  where both  $r$  and  $r'$  have degree less than  $g$  (unless one or both are 0). If  $r \neq r'$ , then  $\deg(r' - r) < \deg(g)$ . On the other hand, since

$$(2) \quad (q - q')g = r' - r,$$

we would have  $q - q' \neq 0$ , and consequently,

$$\deg(r' - r) = \deg((q - q')g) = \deg(q - q') + \deg(g) \geq \deg(g).$$

This contradiction forces  $r = r'$ , and then (2) shows that  $q = q'$ . This completes the proof of the proposition.  $\square$

Most computer algebra systems implement the above algorithm [with some modifications—see DAVENPORT, SIRET, and TOURNIER (1993)] for dividing polynomials.

A useful corollary of the division algorithm concerns the number of roots of a polynomial in one variable.

**Corollary 3.** *If  $k$  is a field and  $f \in k[x]$  is a nonzero polynomial, then  $f$  has at most  $\deg(f)$  roots in  $k$ .*

**Proof.** We will use induction on  $m = \deg(f)$ . When  $m = 0$ ,  $f$  is a nonzero constant, and the corollary is obviously true. Now assume that the corollary holds for all polynomials of degree  $m - 1$ , and let  $f$  have degree  $m$ . If  $f$  has no roots in  $k$ , then we are done. So suppose  $a$  is a root in  $k$ . If we divide  $f$  by  $x - a$ , then Proposition 2 tells

us that  $f = q(x - a) + r$ , where  $r \in k$  since  $x - a$  has degree one. To determine  $r$ , evaluate both sides at  $x = a$ , which gives  $0 = f(a) = q(a)(a - a) + r = r$ . It follows that  $f = q(x - a)$ . Note also that  $q$  has degree  $m - 1$ .

We claim that any root of  $f$  other than  $a$  is also a root of  $q$ . To see this, let  $b \neq a$  be a root of  $f$ . Then  $0 = f(b) = q(b)(b - a)$  implies that  $q(b) = 0$  since  $k$  is a field. Since  $q$  has at most  $m - 1$  roots by our inductive assumption,  $f$  has at most  $m$  roots in  $k$ . This completes the proof.  $\square$

Corollary 3 was used to prove Proposition 5 in §1, which states that  $\mathbf{I}(k^n) = \{0\}$  whenever  $k$  is infinite. This is an example of how a geometric fact can be the consequence of an algorithm.

We can also use Proposition 2 to determine the structure of all ideals of  $k[x]$ .

**Corollary 4.** *If  $k$  is a field, then every ideal of  $k[x]$  can be written in the form  $\langle f \rangle$  for some  $f \in k[x]$ . Furthermore,  $f$  is unique up to multiplication by a nonzero constant in  $k$ .*

**Proof.** Take an ideal  $I \subset k[x]$ . If  $I = \{0\}$ , then we are done since  $I = \langle 0 \rangle$ . Otherwise, let  $f$  be a nonzero polynomial of minimum degree contained in  $I$ . We claim that  $\langle f \rangle = I$ . The inclusion  $\langle f \rangle \subset I$  is obvious since  $I$  is an ideal. Going the other way, take  $g \in I$ . By division algorithm (Proposition 2), we have  $g = qf + r$ , where either  $r = 0$  or  $\deg(r) < \deg(f)$ . Since  $I$  is an ideal,  $qf \in I$  and, thus,  $r = g - qf \in I$ . If  $r$  were not zero, then  $\deg(r) < \deg(f)$ , which would contradict our choice of  $f$ . Thus,  $r = 0$ , so that  $g = qf \in \langle f \rangle$ . This proves that  $I = \langle f \rangle$ .

To study uniqueness, suppose that  $\langle f \rangle = \langle g \rangle$ . Then  $f \in \langle g \rangle$  implies that  $f = hg$  for some polynomial  $h$ . Thus,

$$(3) \quad \deg(f) = \deg(h) + \deg(g),$$

so that  $\deg(f) \geq \deg(g)$ . The same argument with  $f$  and  $g$  interchanged shows  $\deg(f) \leq \deg(g)$ , and it follows that  $\deg(f) = \deg(g)$ . Then (3) implies  $\deg(h) = 0$ , so that  $h$  is a nonzero constant.  $\square$

In general, an ideal generated by one element is called a *principal ideal*. In view of Corollary 4, we say that  $k[x]$  is a *principal ideal domain*, abbreviated PID.

The proof of Corollary 4 tells us that the generator of an ideal in  $k[x]$  is the nonzero polynomial of minimum degree contained in the ideal. This description is not useful in practice, for it requires that we check the degrees of all polynomials (there are infinitely many) in the ideal. Is there a better way to find the generator? For example, how do we find a generator of the ideal

$$\langle x^4 - 1, x^6 - 1 \rangle \subset k[x]?$$

The tool needed to solve this problem is the greatest common divisor.

**Definition 5.** A **greatest common divisor** of polynomials  $f, g \in k[x]$  is a polynomial  $h$  such that:

- (i)  $h$  divides  $f$  and  $g$ .  
(ii) If  $p$  is another polynomial which divides  $f$  and  $g$ , then  $p$  divides  $h$ . When  $h$  has these properties, we write  $h = \text{GCD}(f, g)$ .

Here are the main properties of GCDs.

**Proposition 6.** *Let  $f, g \in k[x]$ . Then:*

- (i)  $\text{GCD}(f, g)$  exists and is unique up to multiplication by a nonzero constant in  $k$ .  
(ii)  $\text{GCD}(f, g)$  is a generator of the ideal  $\langle f, g \rangle$ .  
(iii) There is an algorithm for finding  $\text{GCD}(f, g)$ .

**Proof.** Consider the ideal  $\langle f, g \rangle$ . Since every ideal of  $k[x]$  is principal (Corollary 4), there exists  $h \in k[x]$  such that  $\langle f, g \rangle = \langle h \rangle$ . We claim that  $h$  is the GCD of  $f, g$ . To see this, first note that  $h$  divides  $f$  and  $g$  since  $f, g \in \langle h \rangle$ . Thus, the first part of Definition 5 is satisfied. Next, suppose that  $p \in k[x]$  divides  $f$  and  $g$ . This means that  $f = Cp$  and  $g = Dp$  for some  $C, D \in k[x]$ . Since  $h \in \langle f, g \rangle$ , there are  $A, B$  such that  $Af + Bg = h$ . Substituting, we obtain

$$h = Af + Bg = ACp + BDp = (AC + BD)p,$$

which shows that  $p$  divides  $h$ . Thus,  $h = \text{GCD}(f, g)$ .

This proves the existence of the GCD. To prove uniqueness, suppose that  $h'$  was another GCD of  $f$  and  $g$ . Then, by the second part of Definition 5,  $h$  and  $h'$  would each divide the other. This easily implies that  $h$  is a nonzero constant multiple of  $h'$ . Thus, part (i) of the corollary is proved, and part (ii) follows by the way we found  $h$  in the above paragraph.

The existence proof just given is not useful in practice. It depends on our ability to find a generator of  $\langle f, g \rangle$ . As we noted in the discussion following Corollary 4, this involves checking the degrees of infinitely many polynomials. Fortunately, there is a classic algorithm, known as the *Euclidean Algorithm*, which computes the GCD of two polynomials in  $k[x]$ . This is what part (iii) of the proposition is all about.

We will need the following notation. Let  $f, g \in k[x]$ , where  $g \neq 0$ , and write  $f = qg + r$ , where  $q$  and  $r$  are as in Proposition 2. Then we set  $r = \text{remainder}(f, g)$ . We can now state the Euclidean Algorithm for finding  $\text{GCD}(f, g)$ :

```

Input:  $f, g$ 
Output:  $h$ 
 $h := f$ 
 $s := g$ 
WHILE  $s \neq 0$  DO
     $rem := \text{remainder}(h, s)$ 
     $h := s$ 
     $s := rem$ 

```

To see why this algorithm computes the GCD, write  $f = qg + r$  as in Proposition 2. We claim that

$$(4) \quad \text{GCD}(f, g) = \text{GCD}(f - qg, g) = \text{GCD}(r, g).$$

To prove this, by part (ii) of the proposition, it suffices to show that the ideals  $\langle f, g \rangle$  and  $\langle f - qg, g \rangle$  are equal. We will leave this easy argument as an exercise.

We can write (4) in the form

$$\text{GCD}(f, g) = \text{GCD}(g, r).$$

Notice that  $\deg(g) > \deg(r)$  or  $r = 0$ . If  $r \neq 0$ , we can make things yet smaller by repeating this process. Thus, we write  $g = q'r + r'$  as in Proposition 2, and arguing as above, we obtain

$$\text{GCD}(g, r) = \text{GCD}(r, r'),$$

where  $\deg(r) > \deg(r')$  or  $r' = 0$ . Continuing in this way, we get

$$(5) \quad \text{GCD}(f, g) = \text{GCD}(g, r) = \text{GCD}(r, r') = \text{GCD}(r', r'') = \dots,$$

where either the degrees drop

$$\deg(g) > \deg(r) > \deg(r') > \deg(r'') > \dots,$$

or the process terminates when one of  $r, r', r'', \dots$  becomes 0.

We can now explain how the Euclidean Algorithm works. The algorithm has variables  $h$  and  $s$ , and we can see these variables in equation (5): the values of  $h$  are the first polynomial in each GCD, and the values of  $s$  are the second. You should check that in (5), going from one GCD to the next is exactly what is done in the WHILE...DO loop of the algorithm. Thus, at every stage of the algorithm,  $\text{GCD}(h, s) = \text{GCD}(f, g)$ .

The algorithm must terminate because the degree of  $s$  keeps dropping, so that at some stage,  $s = 0$ . When this happens, we have  $\text{GCD}(h, 0) = \text{GCD}(f, g)$ , and since  $\langle h, 0 \rangle$  obviously equals  $\langle h \rangle$ , we have  $\text{GCD}(h, 0) = h$ . Combining these last two equations, it follows that  $h = \text{GCD}(f, g)$  when  $s = 0$ . This proves that  $h$  is the GCD of  $f$  and  $g$  when the algorithm terminates, and the proof of Proposition 6 is now complete.  $\square$

We should mention that there is also a version of the Euclidean Algorithm for finding the GCD of two integers. Most computer algebra systems have a command for finding the GCD of two polynomials (or integers) that uses a modified form of the Euclidean Algorithm [see DAVENPORT, SIRET, and TOURNIER (1993) for more details].

For an example of how the Euclidean Algorithm works, let us compute the GCD of  $x^4 - 1$  and  $x^6 - 1$ . First, we use the division algorithm:

$$\begin{aligned} x^4 - 1 &= 0(x^6 - 1) + x^4 - 1, \\ x^6 - 1 &= x^2(x^4 - 1) + x^2 - 1, \\ x^4 - 1 &= (x^2 + 1)(x^2 - 1) + 0. \end{aligned}$$

Then, by equation (5), we have

$$\begin{aligned} \text{GCD}(x^4 - 1, x^6 - 1) &= \text{GCD}(x^6 - 1, x^4 - 1) \\ &= \text{GCD}(x^4 - 1, x^2 - 1) = \text{GCD}(x^2 - 1, 0) = x^2 - 1. \end{aligned}$$

Note that this GCD computation answers our earlier question of finding a generator for the ideal  $\langle x^4 - 1, x^6 - 1 \rangle$ . Namely, Proposition 6 and  $\text{GCD}(x^4 - 1, x^6 - 1) = x^2 - 1$  imply that

$$\langle x^4 - 1, x^6 - 1 \rangle = \langle x^2 - 1 \rangle.$$

At this point, it is natural to ask what happens for an ideal generated by three or more polynomials. How do we find a generator in this case? The idea is to extend the definition of GCD to more than two polynomials.

**Definition 7.** A **greatest common divisor** of polynomials  $f_1, \dots, f_s \in k[x]$  is a polynomial  $h$  such that:

- (i)  $h$  divides  $f_1, \dots, f_s$ .
  - (ii) If  $p$  is another polynomial which divides  $f_1, \dots, f_s$ , then  $p$  divides  $h$ .
- When  $h$  has these properties, we write  $h = \text{GCD}(f_1, \dots, f_s)$ .

Here are the main properties of these GCDs.

**Proposition 8.** Let  $f_1, \dots, f_s \in k[x]$ , where  $s \geq 2$ . Then:

- (i)  $\text{GCD}(f_1, \dots, f_s)$  exists and is unique up to multiplication by a nonzero constant in  $k$ .
- (ii)  $\text{GCD}(f_1, \dots, f_s)$  is a generator of the ideal  $\langle f_1, \dots, f_s \rangle$ .
- (iii) If  $s \geq 3$ , then  $\text{GCD}(f_1, \dots, f_s) = \text{GCD}(f_1, \text{GCD}(f_2, \dots, f_s))$ .
- (iv) There is an algorithm for finding  $\text{GCD}(f_1, \dots, f_s)$ .

**Proof.** The proofs of parts (i) and (ii) are similar to the proofs given in Proposition 6 and will be omitted. To prove part (iii), let  $h = \text{GCD}(f_2, \dots, f_s)$ . We leave it as an exercise to show that

$$\langle f_1, h \rangle = \langle f_1, f_2, \dots, f_s \rangle.$$

By part (ii) of this proposition, we see that

$$\langle \text{GCD}(f_1, h) \rangle = \langle \text{GCD}(f_1, \dots, f_s) \rangle.$$

Then  $\text{GCD}(f_1, h) = \text{GCD}(f_1, \dots, f_s)$  follows from the uniqueness part of Corollary 4, which proves what we want.

Finally, we need to show that there is an algorithm for finding  $\text{GCD}(f_1, \dots, f_s)$ . The basic idea is to combine part (iii) with the Euclidean Algorithm. For example, suppose that we wanted to compute the GCD of four polynomials  $f_1, f_2, f_3, f_4$ . Using part (iii) of the proposition twice, we obtain

$$\begin{aligned} \text{GCD}(f_1, f_2, f_3, f_4) &= \text{GCD}(f_1, \text{GCD}(f_2, f_3, f_4)) \\ (6) \qquad \qquad \qquad &= \text{GCD}(f_1, \text{GCD}(f_2, \text{GCD}(f_3, f_4))). \end{aligned}$$

Then if we use the Euclidean Algorithm three times [once for each GCD in the second line of (6)], we get the GCD of  $f_1, f_2, f_3, f_4$ . In the exercises, you will be asked to write pseudocode for an algorithm that implements this idea for an arbitrary number of polynomials. Proposition 8 is proved.  $\square$

The GCD command in most computer algebra systems only handles two polynomials at a time. Thus, to work with more than two polynomials, you will need to use the method described in the proof of Proposition 8. For an example, consider the ideal

$$\langle x^3 - 3x + 2, x^4 - 1, x^6 - 1 \rangle \subset k[x].$$

We know that  $\text{GCD}(x^3 - 3x + 2, x^4 - 1, x^6 - 1)$  is a generator. Furthermore, you can check that

$$\begin{aligned} \text{GCD}(x^3 - 3x + 2, x^4 - 1, x^6 - 1) &= \text{GCD}(x^3 - 3x + 2, \text{GCD}(x^4 - 1, x^6 - 1)) \\ &= \text{GCD}(x^3 - 3x + 2, x^2 - 1) = x - 1. \end{aligned}$$

It follows that

$$\langle x^3 - 3x + 2, x^4 - 1, x^6 - 1 \rangle = \langle x - 1 \rangle.$$

More generally, given  $f_1, \dots, f_s \in k[x]$ , it is clear that we now have an algorithm for finding a generator of  $\langle f_1, \dots, f_s \rangle$ .

For another application of the algorithms developed here, consider the *ideal membership problem* from §4: given  $f_1, \dots, f_s \in k[x]$ , is there an algorithm for deciding whether a given polynomial  $f \in k[x]$  lies in the ideal  $\langle f_1, \dots, f_s \rangle$ ? The answer is yes, and the algorithm is easy to describe. The first step is to use GCDs to find a generator  $h$  of  $\langle f_1, \dots, f_s \rangle$ . Then, since  $f \in \langle f_1, \dots, f_s \rangle$  is equivalent to  $f \in \langle h \rangle$ , we need only use the division algorithm to write  $f = qh + r$ , where  $\deg(r) < \deg(h)$ . It follows that  $f$  is in the ideal if and only if  $r = 0$ . For example, suppose we wanted to know whether

$$x^3 + 4x^2 + 3x - 7 \in \langle x^3 - 3x + 2, x^4 - 1, x^6 - 1 \rangle.$$

We saw above that  $x - 1$  is a generator of this ideal so that our question can be rephrased as to whether

$$x^3 + 4x^2 + 3x - 7 \in \langle x - 1 \rangle.$$

Dividing, we find that

$$x^3 + 4x^2 + 3x - 7 = (x^2 + 5x + 8)(x - 1) + 1$$

and it follows that  $x^3 + 4x^2 + 3x - 7$  is *not* in the ideal  $\langle x^3 - 3x + 2, x^4 - 1, x^6 - 1 \rangle$ . In Chapter 2, we will solve the ideal membership problem for polynomials in  $k[x_1, \dots, x_n]$  using a similar strategy: we will first find a nice basis of the ideal (called a Groebner basis) and then we will use a generalized division algorithm to determine whether or not a polynomial is in the ideal.

In the exercises, we will see that in the one-variable case, other problems posed in earlier sections can be solved algorithmically using the methods discussed here.

## EXERCISES FOR §5

- Over the complex numbers  $\mathbb{C}$ , Corollary 3 can be stated in a stronger form. Namely, prove that if  $f \in \mathbb{C}[x]$  is a polynomial of degree  $n > 0$ , then  $f$  can be written in the form  $f = c(x - a_1) \cdots (x - a_n)$ , where  $c, a_1, \dots, a_n \in \mathbb{C}$  and  $c \neq 0$ . Hint: Use Theorem 7 of §1. Note that this result holds for *any* algebraically closed field.
- Although Corollary 3 is simple to prove, it has some interesting consequences. For example, consider the  $n \times n$  Vandermonde determinant determined by  $a_1, \dots, a_n$  in a field  $k$ :

$$\det \begin{pmatrix} 1 & a_1 & a_1^2 & \cdots & a_1^{n-1} \\ 1 & a_2 & a_2^2 & \cdots & a_2^{n-1} \\ \vdots & \vdots & \vdots & & \vdots \\ 1 & a_n & a_n^2 & \cdots & a_n^{n-1} \end{pmatrix}.$$

Prove that this determinant is nonzero when the  $a_i$ 's are distinct. Hint: If the determinant is zero, then the columns are linearly dependent. Show that the coefficients of the linear relation determine a polynomial of degree  $\leq n - 1$  which has  $n$  roots. Then use Corollary 3.

- The fact that every ideal of  $k[x]$  is principal (generated by one element) is special to the case of polynomials in one variable. In this exercise we will see why. Namely, consider the ideal  $I = \langle x, y \rangle \subset k[x, y]$ . Prove that  $I$  is not a principal ideal. Hint: If  $x = fg$ , where  $f, g \in k[x, y]$ , then prove that  $f$  or  $g$  is a constant. It follows that the treatment of GCDs given in this section applies only to polynomials in one variable. GCDs can be computed for polynomials of  $\geq 2$  variables, but the theory involved is more complicated [see DAVENPORT, SIRET, and TOURNIER (1993), §4.1.2].
- If  $h$  is the GCD of  $f, g \in k[x]$ , then prove that there are polynomials  $A, B \in k[x]$  such that  $Af + Bg = h$ .
- If  $f, g \in k[x]$ , then prove that  $\langle f - qg, g \rangle = \langle f, g \rangle$  for any  $q$  in  $k[x]$ . This will prove equation (4) in the text.
- Given  $f_1, \dots, f_s \in k[x]$ , let  $h = \text{GCD}(f_2, \dots, f_s)$ . Then use the equality  $\langle h \rangle = \langle f_2, \dots, f_s \rangle$  to show that  $\langle f_1, h \rangle = \langle f_1, f_2, \dots, f_s \rangle$ . This equality is used in the proof of part (iii) of Proposition 8.
- If you are allowed to compute the GCD of only two polynomials at a time (which is true for most computer algebra systems), give pseudocode for an algorithm that computes the GCD of polynomials  $f_1, \dots, f_s \in k[x]$ , where  $s > 2$ . Prove that your algorithm works. Hint: See (6). This will complete the proof of part (iv) of Proposition 8.
- Use a computer algebra system to compute the following GCDs:
  - $\text{GCD}(x^4 + x^2 + 1, x^4 - x^2 - 2x - 1, x^3 - 1)$ .
  - $\text{GCD}(x^3 + 2x^2 - x - 2, x^3 - 2x^2 - x + 2, x^3 - x^2 - 4x + 4)$ .
- Use the method described in the text to decide whether  $x^2 - 4 \in \langle x^3 + x^2 - 4x - 4, x^3 - x^2 - 4x + 4, x^3 - 2x^2 - x + 2 \rangle$ .
- Give pseudocode for an algorithm that has input  $f, g \in k[x]$  and output  $h, A, B \in k[x]$  where  $h = \text{GCD}(f, g)$  and  $Af + Bg = h$ . Hint: The idea is to add variables  $A, B, C, D$  to the algorithm so that  $Af + Bg = h$  and  $Cf + Dg = s$  remain true at every step of the algorithm. Note that the initial values of  $A, B, C, D$  are 1, 0, 0, 1, respectively. You may find it useful to let  $\text{quotient}(f, g)$  denote the quotient of  $f$  on division by  $g$ , i.e., if the division algorithm yields  $f = qg + r$ , then  $q = \text{quotient}(f, g)$ .
- In this exercise we will study the one-variable case of the *consistency problem* from §2. Given  $f_1, \dots, f_s \in k[x]$ , this asks if there is an algorithm to decide whether  $\mathbf{V}(f_1, \dots, f_s)$  is nonempty. We will see that the answer is yes when  $k = \mathbb{C}$ .

- a. Let  $f \in \mathbb{C}[x]$  be a nonzero polynomial. Then use Theorem 7 of §1 to show that  $\mathbf{V}(f) = \emptyset$  if and only if  $f$  is constant.
- b. If  $f_1, \dots, f_s \in \mathbb{C}[x]$ , prove  $\mathbf{V}(f_1, \dots, f_s) = \emptyset$  if and only if  $\text{GCD}(f_1, \dots, f_s) = 1$ .
- c. Describe (in words, not pseudocode) an algorithm for determining whether or not  $\mathbf{V}(f_1, \dots, f_s)$  is nonempty.

When  $k = \mathbb{R}$ , the consistency problem is much more difficult. It requires giving an algorithm that tells whether a polynomial  $f \in \mathbb{R}[x]$  has a real root.

12. This exercise will study the one-variable case of the *Nullstellensatz problem* from §4, which asks for the relation between  $\mathbf{I}(\mathbf{V}(f_1, \dots, f_s))$  and  $\langle f_1, \dots, f_s \rangle$  when  $f_1, \dots, f_s \in \mathbb{C}[x]$ . By using GCDs, we can reduce to the case of a single generator. So, in this problem, we will explicitly determine  $\mathbf{I}(\mathbf{V}(f))$  when  $f \in \mathbb{C}[x]$  is a nonconstant polynomial. Since we are working over the complex numbers, we know by Exercise 1 that  $f$  factors completely, i.e.,

$$f = c(x - a_1)^{r_1} \cdots (x - a_l)^{r_l},$$

where  $a_1, \dots, a_l \in \mathbb{C}$  are distinct and  $c \in \mathbb{C} - \{0\}$ . Define the polynomial

$$f_{\text{red}} = c(x - a_1) \cdots (x - a_l).$$

Note that  $f$  and  $f_{\text{red}}$  have the same roots, but their *multiplicities* may differ. In particular, all roots of  $f_{\text{red}}$  have multiplicity one. It is common to call  $f_{\text{red}}$  the *reduced* or *square-free* part of  $f$ . To explain the latter name, notice that  $f_{\text{red}}$  is the square-free factor of  $f$  of largest degree.

- a. Show that  $\mathbf{V}(f) = \{a_1, \dots, a_l\}$ .
- b. Show that  $\mathbf{I}(\mathbf{V}(f)) = \langle f_{\text{red}} \rangle$ .

Whereas part (b) describes  $\mathbf{I}(\mathbf{V}(f))$ , the answer is not completely satisfactory because we need to factor  $f$  completely to find  $f_{\text{red}}$ . In Exercises 13, 14, and 15 we will show how to determine  $f_{\text{red}}$  without *any* factoring.

13. We will study the formal derivative of  $f = a_0x^n + a_1x^{n-1} + \cdots + a_{n-1}x + a_n \in \mathbb{C}[x]$ . The *formal derivative* is defined by the usual formulas from calculus:

$$f' = na_0x^{n-1} + (n-1)a_1x^{n-2} + \cdots + a_{n-1} + 0.$$

Prove that the following rules of differentiation apply:

$$\begin{aligned} (af)' &= af' \quad \text{when } a \in \mathbb{C}, \\ (f+g)' &= f' + g', \\ (fg)' &= f'g + fg'. \end{aligned}$$

14. In this exercise we will use the differentiation properties of Exercise 13 to compute  $\text{GCD}(f, f')$  when  $f \in \mathbb{C}[x]$ .
- a. Suppose  $f = (x - a)^r h$  in  $\mathbb{C}[x]$ , where  $h(a) \neq 0$ . Then prove that  $f' = (x - a)^{r-1} h_1$ , where  $h_1 \in \mathbb{C}[x]$  does not vanish at  $a$ . Hint: Use the product rule.
- b. Let  $f = c(x - a_1)^{r_1} \cdots (x - a_l)^{r_l}$  be the factorization of  $f$ , where  $a_1, \dots, a_l$  are distinct. Prove that  $f'$  is a product  $f' = (x - a_1)^{r_1-1} \cdots (x - a_l)^{r_l-1} H$ , where  $H \in \mathbb{C}[x]$  is a polynomial vanishing at none of  $a_1, \dots, a_l$ .
- c. Prove that  $\text{GCD}(f, f') = (x - a_1)^{r_1-1} \cdots (x - a_l)^{r_l-1}$ .
15. This exercise is concerned with the square-free part  $f_{\text{red}}$  of a polynomial  $f \in \mathbb{C}[x]$ , which is defined in Exercise 12.
- a. Use Exercise 14 to prove that  $f_{\text{red}}$  is given by the formula

$$f_{\text{red}} = \frac{f}{\text{GCD}(f, f')}.$$



The virtue of this formula is that it allows us to find the square-free part without factoring  $f$ . This allows for much quicker computations.

- b. Use a computer algebra system to find the square-free part of the polynomial

$$x^{11} - x^{10} + 2x^8 - 4x^7 + 3x^5 - 3x^4 + x^3 + 3x^2 - x - 1.$$

16. Use Exercises 12 and 15 to describe (in words, not pseudocode) an algorithm whose input consists of polynomials  $f_1, \dots, f_s \in \mathbb{C}[x]$  and whose output consists of a basis of  $\mathbf{I}(\mathbf{V}(f_1, \dots, f_s))$ . It is *much* more difficult to construct such an algorithm when dealing with polynomials of more than one variable.
17. Find a basis for the ideal  $\mathbf{I}(\mathbf{V}(x^5 - 2x^4 + 2x^2 - x, x^5 - x^4 - 2x^3 + 2x^2 + x - 1))$ .

# 2

## Groebner Bases

### §1 Introduction

In Chapter 1, we have seen how the algebra of the polynomial rings  $k[x_1, \dots, x_n]$  and the geometry of affine algebraic varieties are linked. In this chapter, we will study the method of Groebner bases, which will allow us to solve problems about polynomial ideals in an algorithmic or computational fashion. The method of Groebner bases is also used in several powerful computer algebra systems to study specific polynomial ideals that arise in applications. In Chapter 1, we posed many problems concerning the algebra of polynomial ideals and the geometry of affine varieties. In this chapter and the next, we will focus on four of these problems.

#### *Problems*

- The Ideal Description Problem: Does every ideal  $I \subset k[x_1, \dots, x_n]$  have a finite generating set? In other words, can we write  $I = \langle f_1, \dots, f_s \rangle$  for some  $f_i \in k[x_1, \dots, x_n]$ ?
- The Ideal Membership Problem: Given  $f \in k[x_1, \dots, x_n]$  and an ideal  $I = \langle f_1, \dots, f_s \rangle$ , determine if  $f \in I$ . Geometrically, this is closely related to the problem of determining whether  $\mathbf{V}(f_1, \dots, f_s)$  lies on the variety  $\mathbf{V}(f)$ .
- The Problem of Solving Polynomial Equations: Find all common solutions in  $k^n$  of a system of polynomial equations

$$f_1(x_1, \dots, x_n) = \dots = f_s(x_1, \dots, x_n) = 0.$$

Of course, this is the same as asking for the points in the affine variety  $\mathbf{V}(f_1, \dots, f_s)$ .

- The Implicitization Problem: Let  $V$  be a subset of  $k^n$  given parametrically as

$$\begin{aligned}x_1 &= g_1(t_1, \dots, t_m), \\ &\vdots \\ x_n &= g_n(t_1, \dots, t_m).\end{aligned}$$



We row-reduce the matrix of the system to reduced row echelon form:

$$\begin{pmatrix} 1 & 0 & 1 & 3 \\ 0 & 1 & -1 & -2 \\ 0 & 0 & 0 & 0 \end{pmatrix}.$$

The form of this matrix shows that  $x_3$  is a free variable, and setting  $x_3 = t$  (any element of  $k$ ), we have

$$\begin{aligned} x_1 &= -t + 3, \\ x_2 &= t - 2, \\ x_3 &= t. \end{aligned}$$

These are parametric equations for a line  $L$  in  $k^3$ . The original system of equations (2) presents  $L$  as an affine variety.

In the general case, one performs row operations on the matrix of (1)

$$\begin{pmatrix} a_{11} & \cdots & a_{1n} & -b_1 \\ \vdots & & \vdots & \vdots \\ a_{m1} & \cdots & a_{mn} & -b_m \end{pmatrix}.$$

until it is in *reduced row echelon form* (where the first nonzero entry on each row is 1, and all other entries in the column containing a leading 1 are zero). Then we can find all solutions of the original system (1) by substituting values for the *free variables* in the reduced row echelon form system. In some examples there may be only one solution, or no solutions. This last case will occur, for instance, if the reduced row echelon matrix contains a row  $(0 \dots 0 \ 1)$ , corresponding to the inconsistent equation  $0 = 1$ .

**Example 3.** Once again, take  $n$  arbitrary, and consider the subset  $V$  of  $k^n$  parametrized by

$$(3) \quad \begin{aligned} x_1 &= a_{11}t_1 + \cdots + a_{1m}t_m + b_1, \\ &\vdots \\ x_n &= a_{n1}t_1 + \cdots + a_{nm}t_m + b_n. \end{aligned}$$

We see that  $V$  is an affine linear subspace of  $k^n$  since  $V$  is the image of the mapping  $F : k^m \rightarrow k^n$  defined by

$$F(t_1, \dots, t_m) = (a_{11}t_1 + \cdots + a_{1m}t_m + b_1, \dots, a_{n1}t_1 + \cdots + a_{nm}t_m + b_n).$$

This is a linear mapping, followed by a translation. Let us consider the implicitization problem in this case. In other words, we seek a system of linear equations [as in (1)] whose solutions are the points of  $V$ .

For example, consider the affine linear subspace  $V \subset k^4$  defined by

$$\begin{aligned} x_1 &= t_1 + t_2 + 1, \\ x_2 &= t_1 - t_2 + 3, \\ x_3 &= 2t_1 - 2, \\ x_4 &= t_1 + 2t_2 - 3. \end{aligned}$$

We rewrite the equations by subtracting the  $x_i$  terms and constants from both sides and apply the row reduction algorithm to the corresponding matrix:

$$\begin{pmatrix} 1 & 1 & -1 & 0 & 0 & 0 & -1 \\ 1 & -1 & 0 & -1 & 0 & 0 & -3 \\ 2 & 0 & 0 & 0 & -1 & 0 & 2 \\ 1 & 2 & 0 & 0 & 0 & -1 & 3 \end{pmatrix}$$

(where the coefficients of the  $x_i$  have been placed after the coefficients of the  $t_j$  in each row). We obtain the reduced row echelon form:

$$\begin{pmatrix} 1 & 0 & 0 & 0 & -1/2 & 0 & 1 \\ 0 & 1 & 0 & 0 & 1/4 & -1/2 & 1 \\ 0 & 0 & 1 & 0 & -1/4 & -1/2 & 3 \\ 0 & 0 & 0 & 1 & -3/4 & 1/2 & 3 \end{pmatrix}.$$

Because the entries in the first two columns of rows 3 and 4 are zero, the last two rows of this matrix correspond to the following two equations with no  $t_j$  terms:

$$\begin{aligned} x_1 - (1/4)x_3 - (1/2)x_4 - 3 &= 0, \\ x_2 - (3/4)x_3 + (1/2)x_4 - 3 &= 0. \end{aligned}$$

(Note that this system is also in reduced row echelon form.) These two equations define  $V$  in  $k^4$ .

The same method can be applied to find implicit equations for any affine linear subspace  $V$  given parametrically as in (3): one computes the reduced row echelon form of (3), and the rows involving only  $x_1, \dots, x_n$  give the equations for  $V$ . We thus have an algorithmic solution to the implicitization problem in this case.

Our goal in this chapter will be to develop extensions of the methods used in these examples to systems of polynomial equations of any degrees in any number of variables. What we will see is that a sort of “combination” of row-reduction and division of polynomials—the method of Groebner bases mentioned at the outset—allows us to handle all these problems.

### EXERCISES FOR §1

- Determine whether the given polynomial is in the given ideal  $I \subset \mathbb{R}[x]$  using the method of Example 1.
  - $f(x) = x^2 - 3x + 2$ ,  $I = \langle x - 2 \rangle$ .
  - $f(x) = x^5 - 4x + 1$ ,  $I = \langle x^3 - x^2 + x \rangle$ .
  - $f(x) = x^2 - 4x + 4$ ,  $I = \langle x^4 - 6x^2 + 12x - 8, 2x^3 - 10x^2 + 16x - 8 \rangle$ .
  - $f(x) = x^3 - 1$ ,  $I = \langle x^9 - 1, x^5 + x^3 - x^2 - 1 \rangle$ .
- Find a parametrization of the affine variety defined by each of the following sets of equations:
  - In  $\mathbb{R}^3$  or  $\mathbb{C}^3$ :

$$\begin{aligned} 2x + 3y - z &= 9, \\ x - y &= 1, \\ 3x + 7y - 2z &= 17. \end{aligned}$$

b. In  $\mathbb{R}^4$  or  $\mathbb{C}^4$ :

$$\begin{aligned}x_1 + x_2 - x_3 - x_4 &= 0, \\x_1 - x_2 + x_3 &= 0.\end{aligned}$$

c. In  $\mathbb{R}^3$  or  $\mathbb{C}^3$ :

$$\begin{aligned}y - x^3 &= 0, \\z - x^5 &= 0.\end{aligned}$$

3. Find implicit equations for the affine varieties parametrized as follows.

a. In  $\mathbb{R}^3$  or  $\mathbb{C}^3$ :

$$\begin{aligned}x_1 &= t - 5, \\x_2 &= 2t + 1, \\x_3 &= -t + 6.\end{aligned}$$

b. In  $\mathbb{R}^4$  or  $\mathbb{C}^4$ :

$$\begin{aligned}x_1 &= 2t - 5u, \\x_2 &= t + 2u, \\x_3 &= -t + u, \\x_4 &= t + 3u.\end{aligned}$$

c. In  $\mathbb{R}^3$  or  $\mathbb{C}^3$ :

$$\begin{aligned}x &= t, \\y &= t^4, \\z &= t^7.\end{aligned}$$

4. Let  $x_1, x_2, x_3, \dots$  be an infinite collection of independent variables indexed by the natural numbers. A *polynomial* with coefficients in a field  $k$  in the  $x_i$  is a finite linear combination of (finite) monomials  $x_{i_1}^{e_1} \dots x_{i_n}^{e_n}$ . Let  $R$  denote the set of all polynomials in the  $x_i$ . Note that we can add and multiply elements of  $R$  in the usual way. Thus,  $R$  is the polynomial ring  $k[x_1, x_2, \dots]$  in infinitely many variables.

a. Let  $I = \langle x_1, x_2, x_3, \dots \rangle$  be the set of polynomials of the form  $x_{t_1} f_1 + \dots + x_{t_m} f_m$ , where  $f_j \in R$ . Show that  $I$  is an ideal in the ring  $R$ .

b. Show, arguing by contradiction, that  $I$  has no finite generating set. Hint: It is not enough only to consider subsets of  $\{x_i : i \geq 1\}$ .

5. In this problem you will show that all polynomial parametric curves in  $k^2$  are contained in affine algebraic varieties.

a. Show that the number of distinct monomials  $x^a y^b$  of total degree  $\leq m$  in  $k[x, y]$  is equal to  $(m+1)(m+2)/2$ . [Note: This is the binomial coefficient  $\binom{m+2}{2}$ .]

b. Show that if  $f(t)$  and  $g(t)$  are polynomials of degree  $\leq n$  in  $t$ , then for  $m$  large enough, the “monomials”

$$[f(t)]^a [g(t)]^b$$

with  $a + b \leq m$  are linearly *dependent*.

c. Deduce from part (b) that if  $C : x = f(t), y = g(t)$  is any polynomial parametric curve in  $k^2$ , then  $C$  is contained in  $\mathbf{V}(F)$  for some  $F \in k[x, y]$ .

- d. Generalize parts a, b, and c of this problem to show that any polynomial parametric surface

$$x = f(t, u), \quad y = g(t, u), \quad z = h(t, u)$$

is contained in an algebraic surface  $\mathbf{V}(F)$ , where  $F \in k[x, y, z]$ .

## §2 Orderings on the Monomials in $k[x_1, \dots, x_n]$

If we examine in detail the division algorithm in  $k[x]$  and the row-reduction (Gaussian elimination) algorithm for systems of linear equations (or matrices), we see that a notion of *ordering of terms* in polynomials is a key ingredient of both (though this is not often stressed). For example, in dividing  $f(x) = x^5 - 3x^2 + 1$  by  $g(x) = x^2 - 4x + 7$  by the standard method, we would:

- Write the terms in the polynomials in decreasing order by degree in  $x$ .
- At the first step, the leading term (the term of highest degree) in  $f$  is  $x^5 = x^3 \cdot x^2 = x^3 \cdot$  (leading term in  $g$ ). Thus, we would subtract  $x^3 \cdot g(x)$  from  $f$  to cancel the leading term, leaving  $4x^4 - 7x^3 - 3x^2 + 1$ .
- Then, we would repeat the same process on  $f(x) - x^3 \cdot g(x)$ , etc., until we obtain a polynomial of degree less than 2.

For the division algorithm on polynomials in one variable, then we are dealing with the degree ordering on the one-variable monomials:

$$(1) \quad \dots > x^{m+1} > x^m > \dots > x^2 > x > 1.$$

The success of the algorithm depends on working systematically with the leading terms in  $f$  and  $g$ , and not removing terms “at random” from  $f$  using arbitrary terms from  $g$ .

Similarly, in the row-reduction algorithm on matrices, in any given row, we systematically work with entries to the left first—leading entries are those nonzero entries farthest to the left on the row. On the level of linear equations, this is expressed by ordering the variables  $x_1, \dots, x_n$  as follows:

$$(2) \quad x_1 > x_2 > \dots > x_n.$$

We write the terms in our equations in decreasing order. Furthermore, in an echelon form system, the equations are listed with their leading terms in decreasing order. (In fact, the precise definition of an echelon form system could be given in terms of this ordering—see Exercise 8.)

From the above evidence, we might guess that a major component of any extension of division and row-reduction to arbitrary polynomials in several variables will be an ordering on the terms in polynomials in  $k[x_1, \dots, x_n]$ . In this section, we will discuss the desirable properties such an ordering should have, and we will construct several different examples that satisfy our requirements. Each of these orderings will be useful in different contexts.

First, we note that we can reconstruct the monomial  $x^\alpha = x_1^{\alpha_1} \dots x_n^{\alpha_n}$  from the  $n$ -tuple of exponents  $\alpha = (\alpha_1, \dots, \alpha_n) \in \mathbb{Z}_{\geq 0}^n$ . This observation establishes a one-to-one correspondence between the monomials in  $k[x_1, \dots, x_n]$  and  $\mathbb{Z}_{\geq 0}^n$ . Furthermore, any

ordering  $>$  we establish on the space  $\mathbb{Z}_{\geq 0}^n$  will give us an ordering on monomials: if  $\alpha > \beta$  according to this ordering, we will also say that  $x^\alpha > x^\beta$ .

There are many different ways to define orderings on  $\mathbb{Z}_{\geq 0}^n$ . For our purposes, most of these orderings will not be useful, however, since we will want our orderings to be “compatible” with the algebraic structure of polynomial rings.

To begin, since a polynomial is a sum of monomials, we would like to be able to arrange the terms in a polynomial unambiguously in descending (or ascending) order. To do this, we must be able to compare every pair of monomials to establish their proper relative positions. Thus, we will require that our orderings be *linear or total* orderings. This means that for every pair of monomials  $x^\alpha$  and  $x^\beta$ , exactly one of the three statements

$$x^\alpha > x^\beta, \quad x^\alpha = x^\beta, \quad x^\beta > x^\alpha$$

should be true. A total order is also transitive, so that  $x^\alpha > x^\beta$  and  $x^\beta > x^\gamma$  always imply  $x^\alpha > x^\gamma$ .

Next, we must take into account the effect of the sum and product operations on polynomials. When we add polynomials, after combining like terms, we may simply rearrange the terms present into the appropriate order, so sums present no difficulties. Products are more subtle, however. Since multiplication in a polynomial ring distributes over addition, it suffices to consider what happens when we multiply a monomial times a polynomial. If doing this changed the relative ordering of terms, significant problems could result in any process similar to the division algorithm in  $k[x]$ , in which we must identify the “leading” terms in polynomials. The reason is that the leading term in the product could be different from the product of the monomial and the leading term of the original polynomial.

Hence, we will require that all monomial orderings have the following additional property. If  $x^\alpha > x^\beta$  and  $x^\gamma$  is any monomial, then we require that  $x^\alpha x^\gamma > x^\beta x^\gamma$ . In terms of the exponent vectors, this property means that if  $\alpha > \beta$  in our ordering on  $\mathbb{Z}_{\geq 0}^n$ , then, for all  $\gamma \in \mathbb{Z}_{\geq 0}^n$ ,  $\alpha + \gamma > \beta + \gamma$ .

With these considerations in mind, we make the following definition.

**Definition 1.** A monomial ordering  $>$  on  $k[x_1, \dots, x_n]$  is any relation  $>$  on  $\mathbb{Z}_{\geq 0}^n$ , or equivalently, any relation on the set of monomials  $x^\alpha$ ,  $\alpha \in \mathbb{Z}_{\geq 0}^n$ , satisfying:

- (i)  $>$  is a total (or linear) ordering on  $\mathbb{Z}_{\geq 0}^n$ .
- (ii) If  $\alpha > \beta$  and  $\gamma \in \mathbb{Z}_{\geq 0}^n$ , then  $\alpha + \gamma > \beta + \gamma$ .
- (iii)  $>$  is a well-ordering on  $\mathbb{Z}_{\geq 0}^n$ . This means that every nonempty subset of  $\mathbb{Z}_{\geq 0}^n$  has a smallest element under  $>$ .

The following lemma will help us understand what the well-ordering condition of part (iii) of the definition means.

**Lemma 2.** An order relation  $>$  on  $\mathbb{Z}_{\geq 0}^n$  is a well-ordering if and only if every strictly decreasing sequence in  $\mathbb{Z}_{\geq 0}^n$

$$\alpha(1) > \alpha(2) > \alpha(3) > \dots$$

eventually terminates.



**Proof.** We will prove this in contrapositive form:  $>$  is not a well-ordering if and only if there is an infinite strictly decreasing sequence in  $\mathbb{Z}_{\geq 0}^n$ .

If  $>$  is not a well-ordering, then some nonempty subset  $S \subset \mathbb{Z}_{\geq 0}^n$  has no least element. Now pick  $\alpha(1) \in S$ . Since  $\alpha(1)$  is not the least element, we can find  $\alpha(1) > \alpha(2)$  in  $S$ . Then  $\alpha(2)$  is also not the least element, so that there is  $\alpha(2) > \alpha(3)$  in  $S$ . Continuing this way, we get an infinite strictly decreasing sequence

$$\alpha(1) > \alpha(2) > \alpha(3) > \cdots .$$

Conversely, given such an infinite sequence, then  $\{\alpha(1), \alpha(2), \alpha(3), \dots\}$  is a nonempty subset of  $\mathbb{Z}_{\geq 0}^n$  with no least element, and thus,  $>$  is not a well-ordering.  $\square$

The importance of this lemma will become evident in the sections to follow. It will be used to show that various algorithms must terminate because some term strictly decreases (with respect to a fixed monomial order) at each step of the algorithm.

In §4, we will see that given parts (i) and (ii) in Definition 1, the well-ordering condition of part (iii) is equivalent to  $\alpha \geq 0$  for all  $\alpha \in \mathbb{Z}_{\geq 0}^n$ .

For a simple example of a monomial order, note that the usual numerical order

$$\cdots > m + 1 > m > \cdots > 3 > 2 > 1 > 0$$

on the elements of  $\mathbb{Z}_{\geq 0}$  satisfies the three conditions of Definition 1. Hence, the degree ordering (1) on the monomials in  $k[x]$  is a monomial ordering.

Our first example of an ordering on  $n$ -tuples will be lexicographic order (or **lex** order, for short).

**Definition 3 (Lexicographic Order).** Let  $\alpha = (\alpha_1, \dots, \alpha_n)$  and  $\beta = (\beta_1, \dots, \beta_n) \in \mathbb{Z}_{\geq 0}^n$ . We say  $\alpha >_{lex} \beta$  if, in the vector difference  $\alpha - \beta \in \mathbb{Z}^n$ , the leftmost nonzero entry is positive. We will write  $x^\alpha >_{lex} x^\beta$  if  $\alpha >_{lex} \beta$ .

Here are some examples:

- $(1, 2, 0) >_{lex} (0, 3, 4)$  since  $\alpha - \beta = (1, -1, -4)$ .
- $(3, 2, 4) >_{lex} (3, 2, 1)$  since  $\alpha - \beta = (0, 0, 3)$ .
- The variables  $x_1, \dots, x_n$  are ordered in the usual way [see (2)] by the lex ordering:

$$(1, 0, \dots, 0) >_{lex} (0, 1, 0, \dots, 0) >_{lex} \cdots >_{lex} (0, \dots, 0, 1).$$

so  $x_1 >_{lex} x_2 >_{lex} \cdots >_{lex} x_n$ .

In practice, when we work with polynomials in two or three variables, we will call the variables  $x, y, z$  rather than  $x_1, x_2, x_3$ . We will also assume that the alphabetical order  $x > y > z$  on the variables is used to define the lexicographic ordering unless we explicitly say otherwise.

Lex order is analogous to the ordering of words used in dictionaries (hence the name). We can view the entries of an  $n$ -tuple  $\alpha \in \mathbb{Z}_{\geq 0}^n$  as analogues of the letters in a word. The letters are ordered alphabetically:

$$a > b > \cdots > y > z.$$

Then, for instance,

$$\text{arrow} >_{lex} \text{arson}$$

since the third letter of “arson” comes after the third letter of “arrow” in alphabetical order, whereas the first two letters are the same in both. Since all elements  $\alpha \in \mathbb{Z}_{\geq 0}^n$  have length  $n$ , this analogy only applies to words with a fixed number of letters.

For completeness, we must check that the lexicographic order satisfies the three conditions of Definition 1.

**Proposition 4.** *The lex ordering on  $\mathbb{Z}_{\geq 0}^n$  is a monomial ordering.*

**Proof.** (i) That  $>_{lex}$  is a total ordering follows directly from the definition and the fact that the usual numerical order on  $\mathbb{Z}_{\geq 0}$  is a total ordering.

(ii) If  $\alpha >_{lex} \beta$ , then we have that the leftmost nonzero entry in  $\alpha - \beta$ , say  $\alpha_k - \beta_k$ , is positive. But  $x^\alpha \cdot x^\gamma = x^{\alpha+\gamma}$  and  $x^\beta \cdot x^\gamma = x^{\beta+\gamma}$ . Then in  $(\alpha + \gamma) - (\beta + \gamma) = \alpha - \beta$ , the leftmost nonzero entry is again  $\alpha_k - \beta_k > 0$ .

(iii) Suppose that  $>_{lex}$  were not a well-ordering. Then by Lemma 2, there would be an infinite strictly descending sequence

$$\alpha(1) >_{lex} \alpha(2) >_{lex} \alpha(3) >_{lex} \dots$$

of elements of  $\mathbb{Z}_{\geq 0}^n$ . We will show that this leads to a contradiction.

Consider the first entries of the vectors  $\alpha(i) \in \mathbb{Z}_{\geq 0}^n$ . By the definition of the lex order, these first entries form a nonincreasing sequence of nonnegative integers. Since  $\mathbb{Z}_{\geq 0}$  is well-ordered, the first entries of the  $\alpha(i)$  must “stabilize” eventually. That is, there exists a  $k$  such that all the first components of the  $\alpha(i)$  with  $i \geq k$  are equal.

Beginning at  $\alpha(k)$ , the second and subsequent entries come into play in determining the lex order. The second entries of  $\alpha(k), \alpha(k+1), \dots$  form a nonincreasing sequence. By the same reasoning as before, the second entries “stabilize” eventually as well. Continuing in the same way, we see that for some  $l$ , the  $\alpha(l), \alpha(l+1), \dots$  all are equal. This contradicts the fact that  $\alpha(l) >_{lex} \alpha(l+1)$ .  $\square$

It is important to realize that there are many lex orders, corresponding to how the variables are ordered. So far, we have used lex order with  $x_1 > x_2 > \dots > x_n$ . But given *any* ordering of the variables  $x_1, \dots, x_n$ , there is a corresponding lex order. For example, if the variables are  $x$  and  $y$ , then we get one lex order with  $x > y$  and a second with  $y > x$ . In the general case of  $n$  variables, there are  $n!$  lex orders. In what follows, the phrase “lex order” will refer to the one with  $x_1 > \dots > x_n$  unless otherwise stated.

In lex order, notice that a variable dominates *any* monomial involving only smaller variables, regardless of its total degree. Thus, for the lex order with  $x > y > z$ , we have  $x >_{lex} y^5 z^3$ . For some purposes, we may also want to take the total degrees of the monomials into account and order monomials of bigger degree first. One way to do this is the graded lexicographic order (or **grlex** order).

**Definition 5 (Graded Lex Order).** Let  $\alpha, \beta \in \mathbb{Z}_{\geq 0}^n$ . We say  $\alpha >_{grlex} \beta$  if

$$|\alpha| = \sum_{i=1}^n \alpha_i > |\beta| = \sum_{i=1}^n \beta_i, \quad \text{or} \quad |\alpha| = |\beta| \text{ and } \alpha >_{lex} \beta.$$

We see that grlex orders by total degree first, then “breaks ties” using lex order. Here are some examples:

1.  $(1, 2, 3) >_{grlex} (3, 2, 0)$  since  $|(1, 2, 3)| = 6 > |(3, 2, 0)| = 5$ .
2.  $(1, 2, 4) >_{grlex} (1, 1, 5)$  since  $|(1, 2, 4)| = |(1, 1, 5)|$  and  $(1, 2, 4) >_{lex} (1, 1, 5)$ .
3. The variables are ordered according to the lex order, i.e.,  $x_1 >_{grlex} \cdots >_{grlex} x_n$ . We will leave it as an exercise to show that the grlex ordering satisfies the three conditions of Definition 1. As in the case of lex order, there are  $n!$  grlex orders on  $n$  variables, depending on how the variables are ordered.

Another (somewhat less intuitive) order on monomials is the graded reverse lexicographical order (or grevlex order). Even though this ordering “takes some getting used to,” it has recently been shown that for some operations, the grevlex ordering is the most efficient for computations.

**Definition 6 (Graded Reverse Lex Order).** Let  $\alpha, \beta \in \mathbb{Z}_{\geq 0}^n$ . We say  $\alpha >_{grevlex} \beta$  if

$$|\alpha| = \sum_{i=1}^n \alpha_i > |\beta| = \sum_{i=1}^n \beta_i, \quad \text{or} \quad |\alpha| = |\beta| \text{ and the rightmost nonzero entry of } \alpha - \beta \in \mathbb{Z}^n \text{ is negative.}$$

Like grlex, grevlex orders by total degree, but it “breaks ties” in a different way. For example:

1.  $(4, 7, 1) >_{grevlex} (4, 2, 3)$  since  $|(4, 7, 1)| = 12 > |(4, 2, 3)| = 9$ .
2.  $(1, 5, 2) >_{grevlex} (4, 1, 3)$  since  $|(1, 5, 2)| = |(4, 1, 3)|$  and  $(1, 5, 2) - (4, 1, 3) = (-3, 4, -1)$ .

You will show in the exercises that the grevlex ordering gives a monomial ordering.

Note also that lex and grevlex give the same ordering on the variables. That is,

$$(1, 0, \dots, 0) >_{grevlex} (0, 1, \dots, 0) >_{grevlex} \cdots >_{grevlex} (0, \dots, 0, 1)$$

or

$$x_1 >_{grevlex} x_2 >_{grevlex} \cdots >_{grevlex} x_n.$$

Thus, grevlex is really different from the grlex order with the variables rearranged (as one might be tempted to believe from the name).

To explain the relation between grlex and grevlex, note that both use total degree in the same way. To break a tie, grlex uses lex order, so that it looks at the leftmost (or largest) variable and favors the *larger* power. In contrast, when grevlex finds the same total degree, it looks at the rightmost (or smallest) variable and favors the *smaller* power. In the exercises, you will check that this amounts to a “double-reversal” of lex order. For example,

$$x^5 yz >_{grlex} x^4 yz^2,$$

since both monomials have total degree 7 and  $x^5yz >_{lex} x^4yz^2$ . In this case, we also have

$$x^5yz >_{grevlex} x^4yz^2,$$

but for a different reason:  $x^5yz$  is larger because the smaller variable  $z$  appears to a smaller power.

As with lex and grlex, there are  $n!$  grevlex orderings corresponding to how the  $n$  variables are ordered.

There are many other monomial orders besides the ones considered here. Some of these will be explored in the exercises to §4. Most computer algebra systems implement lex order, and most also allow other orders, such as grlex and grevlex. Once such an order is chosen, these systems allow the user to specify any of the  $n!$  orderings of the variables. As we will see in §8 of this chapter and in later chapters, this facility becomes very useful when studying a variety of questions.

We will end this section with a discussion of how a monomial ordering can be applied to polynomials. If  $f = \sum_{\alpha} a_{\alpha}x^{\alpha}$  is a polynomial in  $k[x_1, \dots, x_n]$  and we have selected a monomial ordering  $>$ , then we can order the monomials of  $f$  in an unambiguous way with respect to  $>$ . For example, let  $f = 4xy^2z + 4z^2 - 5x^3 + 7x^2z^2 \in k[x, y, z]$ . Then:

- a. With respect to the lex order, we would reorder the terms of  $f$  in decreasing order as

$$f = -5x^3 + 7x^2z^2 + 4xy^2z + 4z^2.$$

- b. With respect to the grlex order, we would have

$$f = 7x^2z^2 + 4xy^2z - 5x^3 + 4z^2.$$

- c. With respect to the grevlex order, we would have

$$f = 4xy^2z + 7x^2z^2 - 5x^3 + 4z^2.$$

We will use the following terminology.

**Definition 7.** Let  $f = \sum_{\alpha} a_{\alpha}x^{\alpha}$  be a nonzero polynomial in  $k[x_1, \dots, x_n]$  and let  $>$  be a monomial order.

- (i) The **multidegree** of  $f$  is

$$\text{multideg}(f) = \max(\alpha \in \mathbb{Z}_{\geq 0}^n : a_{\alpha} \neq 0)$$

(the maximum is taken with respect to  $>$ ).

- (ii) The **leading coefficient** of  $f$  is

$$\text{LC}(f) = a_{\text{multideg}(f)} \in k.$$

- (iii) The **leading monomial** of  $f$  is

$$\text{LM}(f) = x^{\text{multideg}(f)}$$

(with coefficient 1).

(iv) *The leading term of  $f$  is*

$$\text{LT}(f) = \text{LC}(f) \cdot \text{LM}(f).$$

To illustrate, let  $f = 4xy^2z + 4z^2 - 5x^3 + 7x^2z^2$  as before and let  $>$  denote the lex order. Then

$$\begin{aligned} \text{multideg}(f) &= (3, 0, 0), \\ \text{LC}(f) &= -5, \\ \text{LM}(f) &= x^3, \\ \text{LT}(f) &= -5x^3. \end{aligned}$$

In the exercises, you will show that the multidegree has the following useful properties.

**Lemma 8.** *Let  $f, g \in k[x_1, \dots, x_n]$  be nonzero polynomials. Then:*

- (i)  *$\text{multideg}(fg) = \text{multideg}(f) + \text{multideg}(g)$ .*
- (ii) *If  $f + g \neq 0$ , then  $\text{multideg}(f + g) \leq \max(\text{multideg}(f), \text{multideg}(g))$ . If, in addition,  $\text{multideg}(f) \neq \text{multideg}(g)$ , then equality occurs.*

From now on, we will assume that one particular monomial order has been selected, and that leading terms, etc., will be computed relative to that order only.

## EXERCISES FOR §2

1. Rewrite each of the following polynomials, ordering the terms using the lex order, the grlex order, and the grevlex order, giving  $\text{LM}(f)$ ,  $\text{LT}(f)$ , and  $\text{multideg}(f)$  in each case.
  - a.  $f(x, y, z) = 2x + 3y + z + x^2 - z^2 + x^3$ .
  - b.  $f(x, y, z) = 2x^2y^8 - 3x^5yz^4 + xyz^3 - xy^4$ .
2. Each of the following polynomials is written with its monomials ordered according to (exactly) one of lex, grlex, or grevlex order. Determine which monomial order was used in each case.
  - a.  $f(x, y, z) = 7x^2y^4z - 2xy^6 + x^2y^2$ .
  - b.  $f(x, y, z) = xy^3z + xy^2z^2 + x^2z^3$ .
  - c.  $f(x, y, z) = x^4y^5z + 2x^3y^2z - 4xy^2z^4$ .
3. Repeat Exercise 1 when the variables are ordered  $z > y > x$ .
4. Show that grlex is a monomial order according to Definition 1.
5. Show that grevlex is a monomial order according to Definition 1.
6. Another monomial order is the **inverse lexicographic** or **invlex** order defined by the following: for  $\alpha, \beta \in \mathbb{Z}_{>0}^n$ ,  $\alpha >_{\text{invlex}} \beta$  if and only if, in  $\alpha - \beta$ , the rightmost nonzero entry is positive. Show that invlex is equivalent to the lex order with the variables permuted in a certain way. (Which permutation?)
7. Let  $>$  be any monomial order.
  - a. Show that  $\alpha \geq 0$  for all  $\alpha \in \mathbb{Z}_{\geq 0}^n$ .
  - b. Show that if  $x^\alpha$  divides  $x^\beta$ , then  $\alpha \leq \beta$ . Is the converse true?
  - c. Show that if  $\alpha \in \mathbb{Z}_{\geq 0}^n$ , then  $\alpha$  is the smallest element of  $\alpha + \mathbb{Z}_{\geq 0}^n$ .
8. Write a precise definition of what it means for a system of linear equations to be in echelon form, using the ordering given in equation (2).

9. In this exercise, we will study grevlex in more detail. Let  $>_{invlex}$ , be the order given in Exercise 6, and define  $>_{rinvlex}$  to be the reversal of this ordering, i.e., for  $\alpha, \beta \in \mathbb{Z}_{\geq 0}^n$ .

$$\alpha >_{rinvlex} \beta \iff \beta >_{invlex} \alpha.$$

Notice that rinvlex is a “double reversal” of lex, in the sense that we first reverse the order of the variables and then we reverse the ordering itself.

- a. Show that  $\alpha >_{grevlex} \beta$  if and only if  $|\alpha| > |\beta|$ , or  $|\alpha| = |\beta|$  and  $\alpha >_{rinvlex} \beta$ .
  - b. Is rinvlex a monomial ordering according to Definition 1? If so, prove it; if not, say which properties fail.
10. In  $\mathbb{Z}_{\geq 0}$  with the usual ordering, between any two integers, there are only a finite number of other integers. Is this necessarily true in  $\mathbb{Z}_{\geq 0}^n$  for a monomial order? Is it true for the grlex order?
11. Let  $>$  be a monomial order on  $k[x_1, \dots, x_n]$ .
- a. Let  $f \in k[x_1, \dots, x_n]$  and let  $m$  be a monomial. Show that  $LT(m \cdot f) = m \cdot LT(f)$ .
  - b. Let  $f, g \in k[x_1, \dots, x_n]$ . Is  $LT(f \cdot g)$  necessarily the same as  $LT(f) \cdot LT(g)$ ?
  - c. If  $f_i, g_i \in k[x_1, \dots, x_n]$ ,  $1 \leq i \leq s$ , is  $LM(\sum_{i=1}^s f_i g_i)$  necessarily equal to  $LM(f_i) \cdot LM(g_i)$  for some  $i$ ?
12. Lemma 8 gives two properties of the multidegree.
- a. Prove Lemma 8. Hint: The arguments used in Exercise 11 may be relevant.
  - b. Suppose that  $\text{multideg}(f) = \text{multideg}(g)$  and  $f + g \neq 0$ . Give examples to show that  $\text{multideg}(f + g)$  may or may not equal  $\max(\text{multideg}(f), \text{multideg}(g))$ .

### §3 A Division Algorithm in $k[x_1, \dots, x_n]$

In §1, we saw how the division algorithm could be used to solve the ideal membership problem for polynomials of one variable. To study this problem when there are more variables, we will formulate a division algorithm for polynomials in  $k[x_1, \dots, x_n]$  that extends the algorithm for  $k[x]$ . In the general case, the goal is to divide  $f \in k[x_1, \dots, x_n]$  by  $f_1, \dots, f_s \in k[x_1, \dots, x_n]$ . As we will see, this means expressing  $f$  in the form

$$f = a_1 f_1 + \dots + a_s f_s + r,$$

where the “quotients”  $a_1, \dots, a_s$  and remainder  $r$  lie in  $k[x_1, \dots, x_n]$ . Some care will be needed in deciding how to characterize the remainder. This is where we will use the monomial orderings introduced in §2. We will then see how the division algorithm applies to the ideal membership problem.

The basic idea of the algorithm is the same as in the one-variable case: we want to cancel the leading term of  $f$  (with respect to a fixed monomial order) by multiplying some  $f_i$  by an appropriate monomial and subtracting. Then this monomial becomes a term in the corresponding  $a_i$ . Rather than state the algorithm in general, let us first work through some examples to see what is involved.

**Example 1.** We will first divide  $f = xy^2 + 1$  by  $f_1 = xy + 1$  and  $f_2 = y + 1$ , using lex order with  $x > y$ . We want to employ the same scheme as for division of one-variable polynomials, the difference being that there are now several divisors and quotients. Listing the divisors  $f_1, f_2$  and the quotients  $a_1, a_2$  *vertically*, we have the







The above example is a fairly complete illustration of how the division algorithm works. It also shows us what property we want the remainder to have: none of its terms should be divisible by the leading terms of the polynomials by which we are dividing. We can now state the general form of the division algorithm.

**Theorem 3 (Division Algorithm in  $k[x_1, \dots, x_n]$ ).** Fix a monomial order  $>$  on  $\mathbb{Z}_{\geq 0}^n$ , and let  $F = (f_1, \dots, f_s)$  be an ordered  $s$ -tuple of polynomials in  $k[x_1, \dots, x_n]$ . Then every  $f \in k[x_1, \dots, x_n]$  can be written as

$$f = a_1 f_1 + \dots + a_s f_s + r,$$

where  $a_i, r \in k[x_1, \dots, x_n]$ , and either  $r = 0$  or  $r$  is a linear combination, with coefficients in  $k$ , of monomials, none of which is divisible by any of  $\text{LT}(f_1), \dots, \text{LT}(f_s)$ . We will call  $r$  a **remainder** of  $f$  on division by  $F$ . Furthermore, if  $a_i f_i \neq 0$ , then we have

$$\text{multideg}(f) \geq \text{multideg}(a_i f_i).$$

**Proof.** We prove the existence of  $a_1, \dots, a_s$  and  $r$  by giving an algorithm for their construction and showing that it operates correctly on any given input. We recommend that the reader review the division algorithm in  $k[x]$  given in Proposition 2 of Chapter 1, §5 before studying the following generalization:

```

Input:  $f_1, \dots, f_s, f$ 
Output:  $a_1, \dots, a_s, r$ 
 $a_1 := 0; \dots; a_s := 0; r := 0$ 
 $p := f$ 
WHILE  $p \neq 0$  DO
     $i := 1$ 
    divisionoccurred := false
    WHILE  $i \leq s$  AND divisionoccurred = false DO
        IF  $\text{LT}(f_i)$  divides  $\text{LT}(p)$  THEN
             $a_i := a_i + \text{LT}(p)/\text{LT}(f_i)$ 
             $p := p - (\text{LT}(p)/\text{LT}(f_i))f_i$ 
            divisionoccurred := true
        ELSE
             $i := i + 1$ 
    IF divisionoccurred = false THEN
         $r := r + \text{LT}(p)$ 
         $p := p - \text{LT}(p)$ 

```

We can relate this algorithm to the previous example by noting that the variable  $p$  represents the intermediate dividend at each stage, the variable  $r$  represents the column on the right-hand side, and the variables  $a_1, \dots, a_s$  are the quotients listed above the radical. Finally, the boolean variable “divisionoccurred” tells us when some  $\text{LT}(f_i)$  divides the leading term of the intermediate dividend. You should check that each time we go through the main WHILE ... DO loop, precisely one of two things happens:

- (Division Step) If some  $\text{LT}(f_i)$  divides  $\text{LT}(p)$ , then the algorithm proceeds as in the one-variable case.
- (Remainder Step) If no  $\text{LT}(f_i)$  divides  $\text{LT}(p)$ , then the algorithm adds  $\text{LT}(p)$  to the remainder.

These steps correspond exactly to what we did in Example 2.

To prove that the algorithm works, we will first show that

$$(2) \quad f = a_1 f_1 + \dots + a_s f_s + p + r$$

holds at every stage. This is clearly true for the initial values of  $a_1, \dots, a_s, p$ , and  $r$ . Now suppose that (2) holds at one step of the algorithm. If the next step is a Division Step, then some  $\text{LT}(f_i)$  divides  $\text{LT}(p)$ , and the equality

$$a_i f_i + p = (a_i + \text{LT}(p)/\text{LT}(f_i)) f_i + (p - (\text{LT}(p)/\text{LT}(f_i)) f_i)$$

shows that  $a_i f_i + p$  is unchanged. Since all other variables are unaffected, (2) remains true in this case. On the other hand, if the next step is a Remainder Step, then  $p$  and  $r$  will be changed, but the sum  $p + r$  is unchanged since

$$p + r = (p - \text{LT}(p)) + (r + \text{LT}(p)).$$

As before, equality (2) is still preserved.

Next, notice that the algorithm comes to a halt when  $p = 0$ . In this situation, (2) becomes

$$f = a_1 f_1 + \dots + a_s f_s + r.$$

Since terms are added to  $r$  only when they are divisible by none of the  $\text{LT}(f_i)$ , it follows that  $a_1, \dots, a_s$  and  $r$  have the desired properties when the algorithm terminates.

Finally, we need to show that the algorithm does eventually terminate. The key observation is that each time we redefine the variable  $p$ , either its multidegree drops (relative to our term ordering) or it becomes 0. To see this, first suppose that during a Division Step,  $p$  is redefined to be

$$p' = p - \frac{\text{LT}(p)}{\text{LT}(f_i)} f_i.$$

By Lemma 8 of §2, we have

$$\text{LT} \left( \frac{\text{LT}(p)}{\text{LT}(f_i)} f_i \right) = \frac{\text{LT}(p)}{\text{LT}(f_i)} \text{LT}(f_i) = \text{LT}(p),$$

so that  $p$  and  $(\text{LT}(p)/\text{LT}(f_i)) f_i$  have the same leading term. Hence, their difference  $p'$  must have strictly smaller multidegree when  $p' \neq 0$ . Next, suppose that during a Remainder Step,  $p$  is redefined to be

$$p' = p - \text{LT}(p).$$

Here, it is obvious that  $\text{multideg}(p') < \text{multideg}(p)$  when  $p' \neq 0$ . Thus, in either case, the multidegree must decrease. If the algorithm never terminated, then we would get an infinite decreasing sequence of multidegrees. The well-ordering property of  $>$ , as stated

in Lemma 2 of §2, shows that this cannot occur. Thus  $p = 0$  must happen eventually, so that the algorithm terminates after finitely many steps.

It remains to study the relation between  $\text{multideg}(f)$  and  $\text{multideg}(a_i f_i)$ . Every term in  $a_i$  is of the form  $\text{LT}(p)/\text{LT}(f_i)$  for some value of the variable  $p$ . The algorithm starts with  $p = f$ , and we just finished proving that the multidegree of  $p$  decreases. This shows that  $\text{LT}(p) \leq \text{LT}(f)$ , and then it follows easily [using condition (ii) of the definition of a monomial order] that  $\text{multideg}(a_i f_i) \leq \text{multideg}(f)$  when  $a_i f_i \neq 0$  (see Exercise 4). This completes the proof of the theorem.  $\square$

The algebra behind the division algorithm is very simple (there is nothing beyond high school algebra in what we did), which makes it surprising that this form of the algorithm was first isolated and exploited only within the past 40 years.

We will conclude this section by asking whether the division algorithm has the same nice properties as the one-variable version. Unfortunately, the answer is not pretty—the examples given below will show that the division algorithm is far from perfect. In fact, the algorithm achieves its full potential only when coupled with the Groebner bases studied in §§5 and 6.

A first important property of the division algorithm in  $k[x]$  is that the remainder is uniquely determined. To see how this can fail when there is more than one variable, consider the following example.

**Example 4.** Let us divide  $f = x^2y + xy^2 + y^2$  by  $f_1 = y^2 - 1$  and  $f_2 = xy - 1$ . We will use lex order with  $x > y$ . This is the same as Example 2, except that we have changed the order of the divisors. For practice, we suggest that the reader should do the division. You should get the following answer:

$$\begin{array}{r}
 a_1 : x + 1 \\
 a_2 : x \\
 \hline
 y^2 - 1 \quad \left| \begin{array}{l} x^2y + xy^2 + y^2 \\ x^2y - x \end{array} \right. \qquad \qquad \qquad \underline{\qquad} \quad r \\
 xy - 1 \quad \left| \begin{array}{l} x^2y - x \\ \hline xy^2 + x + y^2 \\ xy^2 - x \\ \hline 2x + y^2 \\ \hline y^2 \qquad \qquad \qquad \rightarrow \quad 2x \\ y^2 - 1 \\ \hline 1 \qquad \qquad \qquad \rightarrow \quad 2x + 1 \\ \hline \overline{0} \qquad \qquad \qquad \rightarrow \quad 2x + 1 \end{array} \right.
 \end{array}$$

This shows that

$$(3) \quad x^2y + xy^2 + y^2 = (x + 1) \cdot (y^2 - 1) + x \cdot (xy - 1) + 2x + 1.$$

If you compare this with equation (1), you will see that the remainder is different from what we got in Example 2.

This shows that the remainder  $r$  is not uniquely characterized by the requirement that none of its terms be divisible by  $\text{LT}(f_1), \dots, \text{LT}(f_s)$ . The situation is not completely chaotic: if we follow the algorithm precisely as stated [most importantly, testing  $\text{LT}(p)$  for divisibility by  $\text{LT}(f_1), \text{LT}(f_2), \dots$  in that order], then  $a_1, \dots, a_s$  and  $r$  are uniquely determined. (See Exercise 11 for a more detailed discussion of how to characterize the output of the algorithm.) However, Examples 2 and 4 show that the *ordering* of the  $s$ -tuple of polynomials  $(f_1, \dots, f_s)$  definitely matters, both in the number of steps the algorithm will take to complete the calculation and in the results. The  $a_i$  and  $r$  can change if we simply rearrange the  $f_i$ . (The  $a_i$  and  $r$  may also change if we change the monomial ordering, but that is another story.)

One nice feature of the division algorithm in  $k[x]$  is the way it solves the ideal membership problem—recall Example 1 from §1. Do we get something similar for several variables? One implication is an easy corollary of Theorem 3: if after division of  $f$  by  $F = (f_1, \dots, f_s)$  we obtain a remainder  $r = 0$ , then

$$f = a_1 f_1 + \dots + a_s f_s,$$

so that  $f \in \langle f_1, \dots, f_s \rangle$ . Thus  $r = 0$  is a *sufficient* condition for ideal membership. However, as the following example shows,  $r = 0$  is not a *necessary* condition for being in the ideal.

**Example 5.** Let  $f_1 = xy + 1$ ,  $f_2 = y^2 - 1 \in k[x, y]$  with the lex order. Dividing  $f = xy^2 - x$  by  $F = (f_1, f_2)$ , the result is

$$xy^2 - x = y \cdot (xy + 1) + 0 \cdot (y^2 - 1) + (-x - y).$$

With  $F = (f_2, f_1)$ , however, we have

$$xy^2 - x = x \cdot (y^2 - 1) + 0 \cdot (xy + 1) + 0.$$

The second calculation shows that  $f \in \langle f_1, f_2 \rangle$ . Then the first calculation shows that even if  $f \in \langle f_1, f_2 \rangle$ , it is still possible to obtain a nonzero remainder on division by  $F = (f_1, f_2)$ .

Thus, we must conclude that the division algorithm given in Theorem 3 is an imperfect generalization of its one-variable counterpart. To remedy this situation, we turn to one of the lessons learned in Chapter 1. Namely, in dealing with a collection of polynomials  $f_1, \dots, f_s \in k[x_1, \dots, x_n]$ , it is frequently desirable to pass to the ideal  $I$  they generate. This allows the possibility of going from  $f_1, \dots, f_s$  to a different generating set for  $I$ . So we can still ask whether there might be a “good” generating set for  $I$ . For such a set, we would want the remainder  $r$  on division by the “good” generators to be uniquely determined and the condition  $r = 0$  should be *equivalent* to membership in the ideal. In §6, we will see that Groebner bases have exactly these “good” properties.

In the exercises, you will experiment with a computer algebra system to try to discover for yourself what properties a “good” generating set should have. We will give a precise definition of “good” in §5 of this chapter.

**EXERCISES FOR §3**

1. Compute the remainder on division of the given polynomial  $f$  by the ordered set  $F$  (by hand). Use the grlex order, then the lex order in each case.
  - a.  $f = x^7y^2 + x^3y^2 - y + 1$   $F = (xy^2 - x, x - y^3)$ .
  - b. Repeat part a with the order of the pair  $F$  reversed.
2. Compute the remainder on division:
  - a.  $f = xy^2z^2 + xy - yz$   $F = (x - y^2, y - z^3, z^2 - 1)$ .
  - b. Repeat part a with the order of the set  $F$  permuted cyclically.
3. Using a computer algebra system, check your work from Exercises 1 and 2. (You may need to consult documentation to learn whether the system you are using has an explicit polynomial division command or you will need to perform the individual steps of the algorithm yourself.)
4. Let  $f = a_1f_1 + \cdots + a_sf_s + r$  be the output of the division algorithm.
  - a. Complete the proof begun in the text that  $\text{multideg}(f) \geq \text{multideg}(a_i f_i)$  when  $a_i f_i \neq 0$ .
  - b. Prove that  $\text{multideg}(f) \geq \text{multideg}(r)$  when  $r \neq 0$ .

The following problems investigate in greater detail the way the remainder computed by the division algorithm depends on the ordering and the form of the  $s$ -tuple of divisors  $F = (f_1, \dots, f_s)$ . You may wish to use a computer algebra system to perform these calculations.

5. We will study the division of  $f = x^3 - x^2y - x^2z + x$  by  $f_1 = x^2y - z$  and  $f_2 = xy - 1$ .
  - a. Compute using grlex order:

$$r_1 = \text{remainder of } f \text{ on division by } (f_1, f_2).$$

$$r_2 = \text{remainder of } f \text{ on division by } (f_2, f_1).$$

Your results should be *different*. Where in the division algorithm did the difference occur? (You may need to do a few steps by hand here.)

- b. Is  $r = r_1 - r_2$  in the ideal  $\langle f_1, f_2 \rangle$ ? If so, find an explicit expression  $r = Af_1 + Bf_2$ . If not, say why not.
  - c. Compute the remainder of  $r$  on division by  $(f_1, f_2)$ . Why could you have predicted your answer before doing the division?
  - d. Find another polynomial  $g \in \langle f_1, f_2 \rangle$  such that the remainder on division of  $g$  by  $(f_1, f_2)$  is nonzero. Hint:  $(xy + 1) \cdot f_2 = x^2y^2 - 1$ , whereas  $y \cdot f_1 = x^2y^2 - yz$ .
  - e. Does the division algorithm give us a solution for the ideal membership problem for the ideal  $\langle f_1, f_2 \rangle$ ? Explain your answer.
6. Using the grlex order, find an element  $g$  of  $\langle f_1, f_2 \rangle = \langle 2xy^2 - x, 3x^2y - y - 1 \rangle \subset \mathbb{R}[x, y]$  whose remainder on division by  $(f_1, f_2)$  is nonzero. Hint: You can find such a  $g$  where the remainder is  $g$  itself.
  7. Answer the question of Exercise 6 for  $\langle f_1, f_2, f_3 \rangle = \langle x^4y^2 - z, x^3y^3 - 1, x^2y^4 - 2z \rangle \subset \mathbb{R}[x, y, z]$ . Find two different polynomials  $g$  (not constant multiples of each other).
  8. Try to formulate a general pattern that fits the examples in Exercises 5(c,d), 6, and 7. What condition on the leading term of the polynomial  $g = A_1f_1 + \cdots + A_sf_s$  would guarantee that there was a nonzero remainder on division by  $(f_1, \dots, f_s)$ ? What does your condition imply about the ideal membership problem?
  9. The discussion around equation (2) of Chapter 1, §4 shows that every polynomial  $f \in \mathbb{R}[x, y, z]$  can be written as

$$f = h_1(y - x^2) + h_2(z - x^3) + r,$$

where  $r$  is a polynomial in  $x$  alone and  $\mathbf{V}(y - x^2, z - x^3)$  is the twisted cubic curve in  $\mathbb{R}^3$ .

- a. Give a proof of this fact using the division algorithm. Hint: You need to specify carefully the monomial ordering to be used.
- b. Use the parametrization of the twisted cubic to show that  $z^2 - x^4y$  vanishes at every point of the twisted cubic.
- c. Find an explicit representation

$$z^2 - x^4y = h_1(y - x^2) + h_2(z - x^3)$$

using the division algorithm.

10. Let  $V \subset \mathbb{R}^3$  be the curve parametrized by  $(t, t^m, t^n)$ ,  $n, m \geq 2$ .

- a. Show that  $V$  is an affine variety.
- b. Adapt the ideas in Exercise 9 to determine  $\mathbf{I}(V)$ .

11. In this exercise, we will characterize completely the expression

$$f = a_1 f_1 + \cdots + a_s f_s + r$$

that is produced by the division algorithm (among all the possible expressions for  $f$  of this form). Let  $\text{LM}(f_i) = x^{\alpha(i)}$  and define

$$\begin{aligned} \Delta_1 &= \alpha(1) + \mathbb{Z}_{\geq 0}^n, \\ \Delta_2 &= (\alpha(2) + \mathbb{Z}_{\geq 0}^n) - \Delta_1, \\ &\vdots \\ \Delta_s &= (\alpha(s) + \mathbb{Z}_{\geq 0}^n) - \left( \bigcup_{i=1}^{s-1} \Delta_i \right) \\ \overline{\Delta} &= \mathbb{Z}_{\geq 0}^n - \left( \bigcup_{i=1}^s \Delta_i \right). \end{aligned}$$

(Note that  $\mathbb{Z}_{\geq 0}^n$  is the disjoint union of the  $\Delta_i$  and  $\overline{\Delta}$ .)

- a. Show that  $\beta \in \Delta_i$  if and only if  $x^{\alpha(i)}$  divides  $x^\beta$  and no  $x^{\alpha(j)}$  with  $j < i$  divides  $x^\beta$ .
  - b. Show that  $\gamma \in \overline{\Delta}$  if and only if no  $x^{\alpha(i)}$  divides  $x^\gamma$ .
  - c. Show that in the expression  $f = a_1 f_1 + \cdots + a_s f_s + r$  computed by the division algorithm, for every  $i$ , every monomial  $x^\beta$  in  $a_i$  satisfies  $\beta + \alpha(i) \in \Delta_i$ , and every monomial  $x^\gamma$  in  $r$  satisfies  $\gamma \in \overline{\Delta}$ .
  - d. Show that there is exactly one expression  $f = a_1 f_1 + \cdots + a_s f_s + r$  satisfying the properties given in part c.
12. Show that the operation of computing remainders on division by  $F = (f_1 \dots f_s)$  is linear over  $k$ . That is, if the remainder on division of  $g_i$  by  $F$  is  $r_i$ ,  $i = 1, 2$ , then, for any  $c_1, c_2 \in k$ , the remainder on division of  $c_1 g_1 + c_2 g_2$  is  $c_1 r_1 + c_2 r_2$ . Hint: Use Exercise 11.

## §4 Monomial Ideals and Dickson's Lemma

In this section, we will consider the ideal description problem of §1 for the special case of monomial ideals. This will require a careful study of the properties of these ideals. Our results will also have an unexpected application to monomial orderings.

To start, we define monomial ideals in  $k[x_1, \dots, x_n]$ .

**Definition 1.** An ideal  $I \subset k[x_1, \dots, x_n]$  is a **monomial ideal** if there is a subset  $A \subset \mathbb{Z}_{\geq 0}^n$  (possibly infinite) such that  $I$  consists of all polynomials which are finite sums of the form  $\sum_{\alpha \in A} h_\alpha x^\alpha$ , where  $h_\alpha \in k[x_1, \dots, x_n]$ . In this case, we write  $I = \langle x^\alpha : \alpha \in A \rangle$ .

An example of a monomial ideal is given by  $I = \langle x^4 y^2, x^3 y^4, x^2 y^5 \rangle \subset k[x, y]$ . More interesting examples of monomial ideals will be given in §5.

We first need to characterize all monomials that lie in a given monomial ideal.

**Lemma 2.** Let  $I = \langle x^\alpha : \alpha \in A \rangle$  be a monomial ideal. Then a monomial  $x^\beta$  lies in  $I$  if and only if  $x^\beta$  is divisible by  $x^\alpha$  for some  $\alpha \in A$ .

**Proof.** If  $x^\beta$  is a multiple of  $x^\alpha$  for some  $\alpha \in A$ , then  $x^\beta \in I$  by the definition of ideal. Conversely, if  $x^\beta \in I$ , then  $x^\beta = \sum_{i=1}^s h_i x^{\alpha(i)}$ , where  $h_i \in k[x_1, \dots, x_n]$  and  $\alpha(i) \in A$ . If we expand each  $h_i$  as a linear combination of monomials, we see that every term on the right side of the equation is divisible by some  $x^{\alpha(i)}$ . Hence, the left side  $x^\beta$  must have the same property.  $\square$

Note that  $x^\beta$  is divisible by  $x^\alpha$  exactly when  $x^\beta = x^\alpha \cdot x^\gamma$  for some  $\gamma \in \mathbb{Z}_{\geq 0}^n$ . This is equivalent to  $\beta = \alpha + \gamma$ . Thus, the set

$$\alpha + \mathbb{Z}_{\geq 0}^n = \{\alpha + \gamma : \gamma \in \mathbb{Z}_{\geq 0}^n\}$$

consists of the exponents of all monomials divisible by  $x^\alpha$ . This observation and Lemma 2 allows us to draw pictures of the monomials in a given monomial ideal. For example, if  $I = \langle x^4 y^2, x^3 y^4, x^2 y^5 \rangle$ , then the exponents of the monomials in  $I$  form the set

$$((4, 2) + \mathbb{Z}_{\geq 0}^2) \cup ((3, 4) + \mathbb{Z}_{\geq 0}^2) \cup ((2, 5) + \mathbb{Z}_{\geq 0}^2).$$

We can visualize this set as the union of the integer points in three translated copies of the first quadrant in the plane:

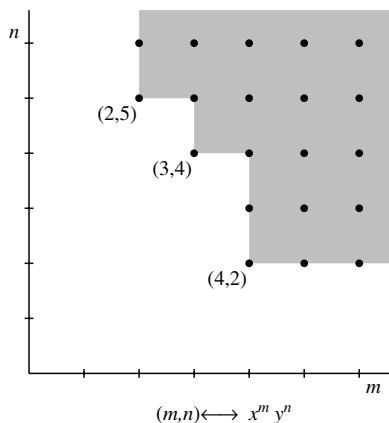

Let us next show that whether a given polynomial  $f$  lies in a monomial ideal can be determined by looking at the monomials of  $f$ .

**Lemma 3.** *Let  $I$  be a monomial ideal, and let  $f \in k[x_1, \dots, x_n]$ . Then the following are equivalent:*

- (i)  $f \in I$ .
- (ii) Every term of  $f$  lies in  $I$ .
- (iii)  $f$  is a  $k$ -linear combination of the monomials in  $I$ .

**Proof.** The implications (iii)  $\Rightarrow$  (ii)  $\Rightarrow$  (i) are trivial. The proof of (i)  $\Rightarrow$  (iii) is similar to what we did in Lemma 2 and is left as an exercise.  $\square$

An immediate consequence of part (iii) of the lemma is that a monomial ideal is uniquely determined by its monomials. Hence, we have the following corollary.

**Corollary 4.** *Two monomial ideals are the same if and only if they contain the same monomials.*

The main result of this section is that all monomial ideals of  $k[x_1, \dots, x_n]$ , are finitely generated.

**Theorem 5 (Dickson's Lemma).** *Let  $I = \langle x^\alpha : \alpha \in A \rangle \subseteq k[x_1, \dots, x_n]$  be a monomial ideal. Then  $I$  can be written in the form  $I = \langle x^{\alpha(1)}, \dots, x^{\alpha(s)} \rangle$ , where  $\alpha(1), \dots, \alpha(s) \in A$ . In particular,  $I$  has a finite basis.*

**Proof.** (By induction on  $n$ , the number of variables.) If  $n = 1$ , then  $I$  is generated by the monomials  $x_1^\alpha$ , where  $\alpha \in A \subset \mathbb{Z}_{\geq 0}$ . Let  $\beta$  be the smallest element of  $A \subset \mathbb{Z}_{\geq 0}$ . Then  $\beta \leq \alpha$  for all  $\alpha \in A$ , so that  $x_1^\beta$  divides all other generators  $x_1^\alpha$ . From here,  $I = \langle x_1^\beta \rangle$  follows easily.

Now assume that  $n > 1$  and that the theorem is true for  $n - 1$ . We will write the variables as  $x_1, \dots, x_{n-1}, y$ , so that monomials in  $k[x_1, \dots, x_{n-1}, y]$  can be written as  $x^\alpha y^m$ , where  $\alpha = (\alpha_1, \dots, \alpha_{n-1}) \in \mathbb{Z}_{\geq 0}^{n-1}$  and  $m \in \mathbb{Z}_{\geq 0}$ .

Suppose that  $I \subset k[x_1, \dots, x_{n-1}, y]$  is a monomial ideal. To find generators for  $I$ , let  $J$  be the ideal in  $k[x_1, \dots, x_{n-1}]$  generated by the monomials  $x^\alpha$  for which  $x^\alpha y^m \in I$  for some  $m \geq 0$ . Since  $J$  is a monomial ideal in  $k[x_1, \dots, x_{n-1}]$ , our inductive hypothesis implies that finitely many of the  $x^\alpha$ 's generate  $J$ , say  $J = \langle x^{\alpha(1)}, \dots, x^{\alpha(s)} \rangle$ . The ideal  $J$  can be understood as the "projection" of  $I$  into  $k[x_1, \dots, x_{n-1}]$ .

For each  $i$  between 1 and  $s$ , the definition of  $J$  tells us that  $x^{\alpha(i)} y^{m_i} \in I$  for some  $m_i \geq 0$ . Let  $m$  be the largest of the  $m_i$ . Then, for each  $k$  between 0 and  $m - 1$ , consider the ideal  $J_k \subset k[x_1, \dots, x_{n-1}]$  generated by the monomials  $x^\beta$  such that  $x^\beta y^k \in I$ . One can think of  $J_k$  as the "slice" of  $I$  generated by monomials containing  $y$  exactly to the  $k$ th power. Using our inductive hypothesis again,  $J_k$  has a finite generating set of monomials, say  $J_k = \langle x^{\alpha_k(1)}, \dots, x^{\alpha_k(s_k)} \rangle$ .



We claim that  $I$  is generated by the monomials in the following list:

$$\begin{aligned} & \text{from } J : x^{\alpha(1)}y^m, \dots, x^{\alpha(s)}y^m, \\ & \text{from } J_0 : x^{\alpha_0(1)}, \dots, x^{\alpha_0(s_0)}, \\ & \text{from } J_1 : x^{\alpha_1(1)}y, \dots, x^{\alpha_1(s_1)}y, \\ & \quad \vdots \\ & \text{from } J_{m-1} : x^{\alpha_{m-1}(1)}y^{m-1}, \dots, x^{\alpha_{m-1}(s_{m-1})}y^{m-1}. \end{aligned}$$

First note that every monomial in  $I$  is divisible by one on the list. To see why, let  $x^\alpha y^p \in I$ . If  $p \geq m$ , then  $x^\alpha y^p$  is divisible by some  $x^{\alpha(i)}y^m$  by the construction of  $J$ . On the other hand, if  $p \leq m-1$ , then  $x^\alpha y^p$  is divisible by some  $x^{\alpha_p(j)}y^p$  by the construction of  $J_p$ . It follows from Lemma 2 that the above monomials generate an ideal having the same monomials as  $I$ . By Corollary 4, this forces the ideals to be the same, and our claim is proved.

To complete the proof of the theorem, we need to show that the finite set of generators can be chosen from a given set of generators for the ideal. If we switch back to writing the variables as  $x_1, \dots, x_n$ , then our monomial ideal is  $I = \langle x^\alpha : \alpha \in A \rangle \subset k[x_1, \dots, x_n]$ . We need to show that  $I$  is generated by finitely many of the  $x^\alpha$ 's, where  $\alpha \in A$ . By the previous paragraph, we know that  $I = \langle x^{\beta(1)}, \dots, x^{\beta(s)} \rangle$  for some monomials  $x^{\beta(i)}$  in  $I$ . Since  $x^{\beta(i)} \in I = \langle x^\alpha : \alpha \in A \rangle$ , Lemma 2 tells us that each  $x^{\beta(i)}$  is divisible by  $x^{\alpha(i)}$  for some  $\alpha(i) \in A$ . From here, it is easy to show that  $I = \langle x^{\alpha(1)}, \dots, x^{\alpha(s)} \rangle$  (see Exercise 6 for the details). This completes the proof.  $\square$

To better understand how the proof of Theorem 5 works, let us apply it to the ideal  $I = \langle x^4y^2, x^3y^4, x^2y^5 \rangle$  discussed earlier in the section. From the picture of the exponents, you can see that the “projection” is  $J = \langle x^2 \rangle \subset k[x]$ . Since  $x^2y^5 \in I$ , we have  $m = 5$ . Then we get the “slices”  $J_k, 0 \leq k \leq 4 = m-1$ , generated by monomials containing  $y^k$ :

$$\begin{aligned} J_0 &= J_1 = \{0\}, \\ J_2 &= J_3 = \langle x^4 \rangle, \\ J_4 &= \langle x^3 \rangle. \end{aligned}$$

These “slices” are easy to see using the picture of the exponents. Then the proof of Theorem 5 gives  $I = \langle x^2y^5, x^4y^2, x^4y^3, x^3y^4 \rangle$ .

Theorem 5 solves the ideal description problem for monomial ideals, for it tells that such an ideal has a finite basis. This, in turn, allows us to solve the ideal membership problem for monomial ideals. Namely, if  $I = \langle x^{\alpha(1)}, \dots, x^{\alpha(s)} \rangle$ , then one can easily show that a given polynomial  $f$  is in  $I$  if and only if the remainder of  $f$  on division by  $x^{\alpha(1)}, \dots, x^{\alpha(s)}$  is zero. See Exercise 9 for the details.

We can also use Dickson’s Lemma to prove the following important fact about monomial orderings in  $k[x_1, \dots, x_n]$ .

**Corollary 6.** *Let  $>$  be a relation on  $\mathbb{Z}_{\geq 0}^n$  satisfying:*

- (i)  $>$  is a total ordering on  $\mathbb{Z}_{\geq 0}^n$ .
  - (ii) if  $\alpha > \beta$  and  $\gamma \in \mathbb{Z}_{\geq 0}^n$ , then  $\alpha + \gamma > \beta + \gamma$ .
- Then  $>$  is well-ordering if and only if  $\alpha \geq 0$  for all  $\alpha \in \mathbb{Z}_{\geq 0}^n$ .

**Proof.**  $\Rightarrow$ : Assuming  $>$  is a well-ordering, let  $\alpha_0$  be the smallest element of  $\mathbb{Z}_{\geq 0}^n$ . It suffices to show  $\alpha_0 \geq 0$ . This is easy: if  $0 > \alpha_0$ , then by hypothesis (ii), we can add  $\alpha_0$  to both sides to obtain  $\alpha_0 > 2\alpha_0$ , which is impossible since  $\alpha_0$  is the smallest element of  $\mathbb{Z}_{\geq 0}^n$ .

$\Leftarrow$ : Assuming that  $\alpha \geq 0$  for all  $\alpha \in \mathbb{Z}_{\geq 0}^n$ , let  $A \subset \mathbb{Z}_{\geq 0}^n$  be nonempty. We need to show that  $A$  has a smallest element. Since  $I = \langle x^\alpha : \alpha \in A \rangle$  is a monomial ideal, Dickson's Lemma gives us  $\alpha(1), \dots, \alpha(s) \in A$  so that  $I = \langle x^{\alpha(1)}, \dots, x^{\alpha(s)} \rangle$ . Relabeling if necessary, we can assume that  $\alpha(1) < \alpha(2) < \dots < \alpha(s)$ . We claim that  $\alpha(1)$  is the smallest element of  $A$ . To prove this, take  $\alpha \in A$ . Then  $x^\alpha \in I = \langle x^{\alpha(1)}, \dots, x^{\alpha(s)} \rangle$ , so that by Lemma 2,  $x^\alpha$  is divisible by some  $x^{\alpha(i)}$ . This tells us that  $\alpha = \alpha(i) + \gamma$  for some  $\gamma \in \mathbb{Z}_{\geq 0}^n$ . Then  $\gamma \geq 0$  and hypothesis (ii) imply that

$$\alpha = \alpha(i) + \gamma \geq \alpha(i) + 0 = \alpha(i) \geq \alpha(1).$$

Thus,  $\alpha(1)$  is the least element of  $A$ . □

As a result of this corollary, the definition of monomial ordering given in Definition 1 of §2 can be simplified. Conditions (i) and (ii) in the definition would be unchanged, but we could replace (iii) by the simpler condition that  $\alpha \geq 0$  for all  $\alpha \in \mathbb{Z}_{\geq 0}^n$ . This makes it *much* easier to verify that a given ordering is actually a monomial ordering. See Exercises 10–12 for some examples.

**EXERCISES FOR §4**

1. Let  $I \subset k[x_1, \dots, x_n]$  be an ideal with the property that for every  $f = \sum c_\alpha x^\alpha \in I$ , every monomial  $x^\alpha$  appearing in  $f$  is also in  $I$ . Show that  $I$  is a monomial ideal.
2. Complete the proof of Lemma 3 begun in the text.
3. Let  $I = \langle x^6, x^2y^3, xy^7 \rangle \subset k[x, y]$ .
  - a. In the  $(m, n)$ -plane, plot the set of exponent vectors  $(m, n)$  of monomials  $x^m y^n$  appearing in elements of  $I$ .
  - b. If we apply the division algorithm to an element  $f \in k[x, y]$ , using the generators of  $I$  as divisors, what terms can appear in the remainder?
4. Let  $I \subset k[x, y]$  be the monomial ideal spanned over  $k$  by the monomials  $x^\beta$  corresponding to  $\beta$  in the shaded region below:

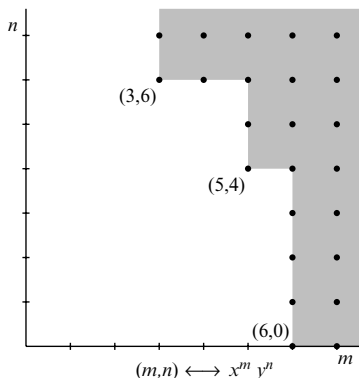

- a. Use the method given in the proof of Theorem 5 to find an ideal basis for  $I$ .
  - b. Is your basis as small as possible, or can some  $\beta$ 's be deleted from your basis, yielding a smaller set that generates the same ideal?
5. Suppose that  $I = \langle x^\alpha : \alpha \in A \rangle$  is a monomial ideal, and let  $S$  be the set of all exponents that occur as monomials of  $I$ . For any monomial order  $>$ , prove that the smallest element of  $S$  with respect to  $>$  must lie in  $A$ .
  6. Let  $I = \langle x^\alpha : \alpha \in A \rangle$  be a monomial ideal, and assume that we have a finite basis  $I = \langle x^{\beta(1)}, \dots, x^{\beta(s)} \rangle$ . In the proof of Dickson's Lemma, we observed that each  $x^{\beta(i)}$  is divisible by  $x^{\alpha(i)}$  for some  $\alpha(i) \in A$ . Prove that  $I = \langle x^{\alpha(1)}, \dots, x^{\alpha(s)} \rangle$ .
  7. Prove that Dickson's Lemma (Theorem 5) is equivalent to the following statement: given a subset  $A \subset \mathbb{Z}_{\geq 0}^n$ , there are finitely many elements  $\alpha(1), \dots, \alpha(s) \in A$  such that for every  $\alpha \in A$ , there exists some  $i$  and some  $\gamma \in \mathbb{Z}_{\geq 0}^n$  such that  $\alpha = \alpha(i) + \gamma$ .
  8. A basis  $\{x^{\alpha(1)}, \dots, x^{\alpha(s)}\}$  for a monomial ideal  $I$  is said to be *minimal* if no  $x^{\alpha(i)}$  in the basis divides another  $x^{\alpha(j)}$  for  $i \neq j$ .
    - a. Prove that every monomial ideal has a minimal basis.
    - b. Show that every monomial ideal has a *unique* minimal basis.
  9. If  $I = \langle x^{\alpha(1)}, \dots, x^{\alpha(s)} \rangle$  is a monomial ideal, prove that a polynomial  $f$  is in  $I$  if and only if the remainder of  $f$  on division by  $x^{\alpha(1)}, \dots, x^{\alpha(s)}$  is zero. Hint: Use Lemmas 2 and 3.
  10. Suppose we have the polynomial ring  $k[x_1, \dots, x_n, y_1, \dots, y_m]$ . Let us define a monomial order  $>_{mixed}$  on this ring that mixes lex order for  $x_1, \dots, x_n$ , with grlex order for  $y_1, \dots, y_m$ . If we write monomials in the  $n + m$  variables as  $x^\alpha y^\beta$ , where  $\alpha \in \mathbb{Z}_{\geq 0}^n$  and  $\beta \in \mathbb{Z}_{\geq 0}^m$ , then we define

$$x^\alpha y^\beta >_{mixed} x^\gamma y^\delta \iff x^\alpha >_{lex} x^\gamma \text{ or } x^\alpha = x^\gamma \text{ and } y^\beta >_{grlex} y^\delta.$$

Use Corollary 6 to prove that  $>_{mixed}$  is a monomial order. This is an example of what is called a *product order*. It is clear that many other monomial orders can be created by this method.

11. In this exercise we will investigate a special case of a *weight order*. Let  $\mathbf{u} = (u_1, \dots, u_n)$  be a vector in  $\mathbb{R}^n$  such that  $u_1, \dots, u_n$  are positive and linearly independent over  $\mathbb{Q}$ . We say that  $\mathbf{u}$  is an *independent weight vector*. Then, for  $\alpha, \beta \in \mathbb{Z}_{\geq 0}^n$ , define

$$\alpha >_{\mathbf{u}} \beta \iff \mathbf{u} \cdot \alpha > \mathbf{u} \cdot \beta,$$

where the centered dot is the usual dot product of vectors. We call  $>_{\mathbf{u}}$  the *weight order* determined by  $\mathbf{u}$ .

- a. Use Corollary 6 to prove that  $>_{\mathbf{u}}$  is a monomial order. Hint: Where does your argument use the linear independence of  $u_1, \dots, u_n$ ?
  - b. Show that  $\mathbf{u} = (1, \sqrt{2})$  is an independent weight vector, so that  $>_{\mathbf{u}}$  is a weight order on  $\mathbb{Z}_{\geq 0}^2$ .
  - c. Show that  $\mathbf{u} = (1, \sqrt{2}, \sqrt{3})$  is an independent weight vector, so that  $>_{\mathbf{u}}$  is a weight order on  $\mathbb{Z}_{\geq 0}^3$ .
12. Another important weight order is constructed as follows. Let  $\mathbf{u} = (u_1, \dots, u_n)$  be in  $\mathbb{Z}_{>0}^n$ , and fix a monomial order  $>_\sigma$  (such as  $>_{lex}$  or  $>_{grlex}$ ) on  $\mathbb{Z}_{\geq 0}^n$ . Then, for  $\alpha, \beta \in \mathbb{Z}_{\geq 0}^n$ , define  $\alpha >_{\mathbf{u},\sigma} \beta$  if and only if

$$\mathbf{u} \cdot \alpha > \mathbf{u} \cdot \beta \text{ or } \mathbf{u} \cdot \alpha = \mathbf{u} \cdot \beta \text{ and } \alpha >_\sigma \beta.$$

We call  $>_{\mathbf{u},\sigma}$  the *weight order* determined by  $\mathbf{u}$  and  $>_\sigma$ .

- a. Use Corollary 6 to prove that  $>_{\mathbf{u},\sigma}$  is a monomial order.
- b. Find  $\mathbf{u} \in \mathbb{Z}_{>0}^n$  so that the weight order  $>_{\mathbf{u},lex}$  is the grlex order  $>_{grlex}$ .

- c. In the definition of  $>_{\mathbf{u},\sigma}$ , the order  $>_{\sigma}$  is used to break ties, and it turns out that ties will *always* occur in this case. More precisely, prove that given  $\mathbf{u} \in \mathbb{Z}_{\geq 0}^n$ , there are  $\alpha \neq \beta$  in  $\mathbb{Z}_{\geq 0}^n$  such that  $\mathbf{u} \cdot \alpha = \mathbf{u} \cdot \beta$ . Hint: Consider the linear equation  $u_1 a_1 + \dots + u_n a_n = 0$  over  $\mathbb{Q}$ . Show that there is a nonzero integer solution  $(a_1, \dots, a_n)$ , and then show that  $(a_1, \dots, a_n) = \alpha - \beta$  for some  $\alpha, \beta \in \mathbb{Z}_{\geq 0}^n$ .
- d. A useful example of a weight order is the *elimination order* introduced by BAYER and STILLMAN (1987b). Fix an integer  $1 \leq i \leq n$  and let  $\mathbf{u} = (1, \dots, 1, 0, \dots, 0)$ , where there are  $i$  1's and  $n - i$  0's. Then the  $i$ th *elimination order*  $>_i$  is the weight order  $>_{\mathbf{u},\text{grevlex}}$ . Prove that  $>_i$  has the following property: if  $x^\alpha$  is a monomial in which one of  $x_1, \dots, x_i$  appears, then  $x^\alpha >_i x^\beta$  for *any* monomial involving only  $x_{i+1}, \dots, x_n$ . Elimination orders play an important role in elimination theory, which we will study in the next chapter.

The weight orders described in Exercises 11 and 12 are only special cases of weight orders. In general, to determine a weight order, one starts with a vector  $\mathbf{u}_1 \in \mathbb{R}^n$ , whose entries may not be linearly independent over  $\mathbb{Q}$ . Then  $\alpha > \beta$  if  $\mathbf{u}_1 \cdot \alpha > \mathbf{u}_1 \cdot \beta$ . But to break ties, one uses a second weight vector  $\mathbf{u}_2 \in \mathbb{R}^n$ . Thus,  $\alpha > \beta$  also holds if  $\mathbf{u}_1 \cdot \alpha = \mathbf{u}_1 \cdot \beta$  and  $\mathbf{u}_2 \cdot \alpha > \mathbf{u}_2 \cdot \beta$ . If there are still ties (when  $\mathbf{u}_1 \cdot \alpha = \mathbf{u}_1 \cdot \beta$  and  $\mathbf{u}_2 \cdot \alpha = \mathbf{u}_2 \cdot \beta$ ), then one uses a third weight vector  $\mathbf{u}_3$ , and so on. It can be proved that *every* monomial order on  $\mathbb{Z}_{\geq 0}^n$  arises in this way. For a detailed treatment of weight orders and their relation to monomial orders, consult ROBBIANO (1986).

## §5 The Hilbert Basis Theorem and Groebner Bases

In this section, we will give a complete solution of the *ideal description problem* from §1. Our treatment will also lead to ideal bases with “good” properties relative to the division algorithm introduced in §3. The key idea we will use is that once we choose a monomial ordering, each  $f \in k[x_1, \dots, x_n]$  has a unique leading term  $\text{LT}(f)$ . Then, for any ideal  $I$ , we can define its *ideal of leading terms* as follows.

**Definition 1.** Let  $I \subset k[x_1, \dots, x_n]$  be an ideal other than  $\{0\}$ .

- (i) We denote by  $\text{LT}(I)$  the set of leading terms of elements of  $I$ . Thus,

$$\text{LT}(I) = \{cx^\alpha : \text{there exists } f \in I \text{ with } \text{LT}(f) = cx^\alpha\}.$$

- (ii) We denote by  $\langle \text{LT}(I) \rangle$  the ideal generated by the elements of  $\text{LT}(I)$ .

We have already seen that leading terms play an important role in the division algorithm. This brings up a subtle but important point concerning  $\langle \text{LT}(I) \rangle$ . Namely, if we are given a finite generating set for  $I$ , say  $I = \langle f_1, \dots, f_s \rangle$ , then  $\langle \text{LT}(f_1), \dots, \text{LT}(f_s) \rangle$  and  $\langle \text{LT}(I) \rangle$  may be *different* ideals. It is true that  $\text{LT}(f_i) \in \text{LT}(I) \subset \langle \text{LT}(I) \rangle$  by definition, which implies  $\langle \text{LT}(f_1), \dots, \text{LT}(f_s) \rangle \subset \langle \text{LT}(I) \rangle$ . However,  $\langle \text{LT}(I) \rangle$  can be strictly larger. To see this, consider the following example.

**Example 2.** Let  $I = \langle f_1, f_2 \rangle$ , where  $f_1 = x^3 - 2xy$  and  $f_2 = x^2y - 2y^2 + x$ , and use the grlex ordering on monomials in  $k[x, y]$ . Then

$$x \cdot (x^2y - 2y^2 + x) - y \cdot (x^3 - 2xy) = x^2,$$

so that  $x^2 \in I$ . Thus  $x^2 = \text{LT}(x^2) \in \langle \text{LT}(I) \rangle$ . However  $x^2$  is not divisible by  $\text{LT}(f_1) = x^3$ , or  $\text{LT}(f_2) = x^2y$ , so that  $x^2 \notin \langle \text{LT}(f_1), \text{LT}(f_2) \rangle$  by Lemma 2 of §4.

In the exercises to §3, you computed other examples of ideals  $I = \langle f_1, \dots, f_s \rangle$ , where  $\langle \text{LT}(I) \rangle$  was strictly bigger than  $\langle \text{LT}(f_1), \dots, \text{LT}(f_s) \rangle$ . The exercises at the end of the section will explore what this implies about the ideal membership problem.

We will now show that  $\langle \text{LT}(I) \rangle$  is a monomial ideal. This will allow us to apply the results of §4. In particular, it will follow that  $\langle \text{LT}(I) \rangle$  is generated by finitely many leading terms.

**Proposition 3.** *Let  $I \subset k[x_1, \dots, x_n]$  be an ideal.*

- (i)  $\langle \text{LT}(I) \rangle$  is a monomial ideal.
- (ii) There are  $g_1, \dots, g_t \in I$  such that  $\langle \text{LT}(I) \rangle = \langle \text{LT}(g_1), \dots, \text{LT}(g_t) \rangle$ .

**Proof.** (i) The leading monomials  $\text{LM}(g)$  of elements  $g \in I - \{0\}$  generate the monomial ideal  $\langle \text{LM}(g) : g \in I - \{0\} \rangle$ . Since  $\text{LM}(g)$  and  $\text{LT}(g)$  differ by a nonzero constant, this ideal equals  $\langle \text{LT}(g) : g \in I - \{0\} \rangle = \langle \text{LT}(I) \rangle$  (see Exercise 4). Thus,  $\langle \text{LT}(I) \rangle$  is a monomial ideal.

(ii) Since  $\langle \text{LT}(I) \rangle$  is generated by the monomials  $\text{LM}(g)$  for  $g \in I - \{0\}$ , Dickson's Lemma from §4 tells us that  $\langle \text{LT}(I) \rangle = \langle \text{LM}(g_1), \dots, \text{LM}(g_t) \rangle$  for finitely many  $g_1, \dots, g_t \in I$ . Since  $\text{LM}(g_i)$  differs from  $\text{LT}(g_i)$  by a nonzero constant, it follows that  $\langle \text{LT}(I) \rangle = \langle \text{LT}(g_1), \dots, \text{LT}(g_t) \rangle$ . This completes the proof.  $\square$

We can now use Proposition 3 and the division algorithm to prove the existence of a finite generating set of every polynomial ideal, thus giving an affirmative answer to the ideal description problem from §1. Let  $I \subset k[x_1, \dots, x_n]$  be any ideal and consider the associated ideal  $\langle \text{LT}(I) \rangle$  as in Definition 1. As always, we have selected one particular monomial order to use in the division algorithm and in computing leading terms.

**Theorem 4 (Hilbert Basis Theorem).** *Every ideal  $I \subset k[x_1, \dots, x_n]$  has a finite generating set. That is,  $I = \langle g_1, \dots, g_t \rangle$  for some  $g_1, \dots, g_t \in I$ .*

**Proof.** If  $I = \{0\}$ , we take our generating set to be  $\{0\}$ , which is certainly finite. If  $I$  contains some nonzero polynomial, then a generating set  $g_1, \dots, g_t$  for  $I$  can be constructed as follows. By Proposition 3, there are  $g_1, \dots, g_t \in I$  such that  $\langle \text{LT}(I) \rangle = \langle \text{LT}(g_1), \dots, \text{LT}(g_t) \rangle$ . We claim that  $I = \langle g_1, \dots, g_t \rangle$ .

It is clear that  $\langle g_1, \dots, g_t \rangle \subset I$  since each  $g_i \in I$ . Conversely, let  $f \in I$  be any polynomial. If we apply the division algorithm from §3 to divide  $f$  by  $\langle g_1, \dots, g_t \rangle$ , then we get an expression of the form

$$f = a_1g_1 + \dots + a_tg_t + r$$

where no term of  $r$  is divisible by any of  $\text{LT}(g_1), \dots, \text{LT}(g_t)$ . We claim that  $r = 0$ . To see this, note that

$$r = f - a_1g_1 - \dots - a_tg_t \in I.$$

If  $r \neq 0$ , then  $\text{LT}(r) \in \langle \text{LT}(I) \rangle = \langle \text{LT}(g_1), \dots, \text{LT}(g_t) \rangle$ , and by Lemma 2 of §4, it follows that  $\text{LT}(r)$  must be divisible by some  $\text{LT}(g_i)$ . This contradicts what it means to be a remainder, and, consequently,  $r$  must be zero. Thus,

$$f = a_1 g_1 + \dots + a_t g_t + 0 \in \langle g_1, \dots, g_t \rangle,$$

which shows that  $I \subset \langle g_1, \dots, g_t \rangle$ . This completes the proof. □

In addition to answering the ideal description question, the basis  $\{g_1, \dots, g_t\}$  used in the proof of Theorem 4 has the special property that  $\langle \text{LT}(I) \rangle = \langle \text{LT}(g_1), \dots, \text{LT}(g_t) \rangle$ . As we saw in Example 2, not all bases of an ideal behave this way. We will give these special bases the following name.

**Definition 5.** Fix a monomial order. A finite subset  $G = \{g_1, \dots, g_t\}$  of an ideal  $I$  is said to be a **Groebner basis** (or **standard basis**) if

$$\langle \text{LT}(g_1), \dots, \text{LT}(g_t) \rangle = \langle \text{LT}(I) \rangle.$$

Equivalently, but more informally, a set  $\{g_1, \dots, g_t\} \subset I$  is a Groebner basis of  $I$  if and only if the leading term of any element of  $I$  is divisible by one of the  $\text{LT}(g_i)$  (this follows from Lemma 2 of §4—see Exercise 5). The proof of Theorem 4 also establishes the following result.

**Corollary 6.** Fix a monomial order. Then every ideal  $I \subset k[x_1, \dots, x_n]$  other than  $\{0\}$  has a Groebner basis. Furthermore, any Groebner basis for an ideal  $I$  is a basis of  $I$ .

**Proof.** Given a nonzero ideal, the set  $G = \{g_1, \dots, g_t\}$  constructed in the proof of Theorem 4 is a Groebner basis by definition. For the second claim, note that if  $\langle \text{LT}(I) \rangle = \langle \text{LT}(g_1), \dots, \text{LT}(g_t) \rangle$ , then the argument given in Theorem 4 shows that  $I = \langle g_1, \dots, g_t \rangle$ , so that  $G$  is a basis for  $I$ . (A slightly different proof is given in Exercise 6.) □

In §6 we will study the properties of Groebner bases in more detail, and, in particular, we will see how they give a solution of the ideal membership problem. Groebner bases are the “good” generating sets we hoped for at the end of §3.

For some examples of Groebner bases, first consider the ideal  $I$  from Example 2, which had the basis  $\{f_1, f_2\} = \{x^3 - 2xy, x^2y - 2y^2 + x\}$ . Then  $\{f_1, f_2\}$  is *not* a Groebner basis for  $I$  with respect to grlex order since we saw in Example 2 that  $x^2 \in \langle \text{LT}(I) \rangle$ , but  $x^2 \notin \langle \text{LT}(f_1), \text{LT}(f_2) \rangle$ . In §7 we will learn how to find a Groebner basis of  $I$ .

Next, consider the ideal  $J = \langle g_1, g_2 \rangle = \langle x + z, y - z \rangle$ . We claim that  $g_1$  and  $g_2$  form a Groebner basis using lex order in  $\mathbb{R}[x, y, z]$ . Thus, we must show that the leading term of every nonzero element of  $J$  lies in the ideal  $\langle \text{LT}(g_1), \text{LT}(g_2) \rangle = \langle x, y \rangle$ . By Lemma 2 of §4, this is equivalent to showing that the leading term of *any* nonzero element of  $J$  is divisible by either  $x$  or  $y$ .

To prove this, consider any  $f = Ag_1 + Bg_2 \in J$ . Suppose on the contrary that  $f$  is nonzero and  $\text{LT}(f)$  is divisible by neither  $x$  nor  $y$ . Then by the definition of lex order,  $f$  must be a polynomial in  $z$  alone. However,  $f$  vanishes on the linear subspace  $L = \mathbf{V}(x+z, y-z) \subset \mathbb{R}^3$  since  $f \in J$ . It is easy to check that  $(x, y, z) = (-t, t, t) \in L$  for any real number  $t$ . The only polynomial in  $z$  alone that vanishes at all of these points is the zero polynomial, which is a contradiction. It follows that  $\langle g_1, g_2 \rangle$  is a Groebner basis for  $J$ . In §6, we will learn a more systematic way to detect when a basis is a Groebner basis.

Note, by the way, that the generators for the ideal  $J$  come from a row echelon matrix of coefficients:

$$\begin{pmatrix} 1 & 0 & 1 \\ 0 & 1 & -1 \end{pmatrix}$$

This is no accident: for ideals generated by linear polynomials, a Groebner basis for lex order is determined by the row echelon form of the matrix made from the coefficients of the generators (see Exercise 9).

Groebner bases for ideals in polynomial rings were introduced in 1965 by B. Buchberger and named by him in honor of W. Gröbner (1899–1980), Buchberger’s thesis adviser. The closely related concept of “standard bases” for ideals in power series rings was discovered independently in 1964 by H. Hironaka. As we will see later in this chapter, Buchberger also developed the fundamental algorithms for working with Groebner bases. We will use the English form “Groebner bases,” since this is how the command is spelled in some computer algebra systems.

We conclude this section with two applications of the Hilbert Basis Theorem. The first is an algebraic statement about the ideals in  $k[x_1, \dots, x_n]$ . An **ascending chain** of ideals is a nested increasing sequence:

$$I_1 \subset I_2 \subset I_3 \subset \dots$$

For example, the sequence

$$(1) \quad \langle x_1 \rangle \subset \langle x_1, x_2 \rangle \subset \dots \subset \langle x_1, \dots, x_n \rangle$$

forms a (finite) ascending chain of ideals. If we try to *extend* this chain by including an ideal with further generator(s), one of two alternatives will occur. Consider the ideal  $\langle x_1, \dots, x_n, f \rangle$  where  $f \in k[x_1, \dots, x_n]$ . If  $f \in \langle x_1, \dots, x_n \rangle$ , then we obtain  $\langle x_1, \dots, x_n \rangle$  again and nothing has changed. If, on the other hand,  $f \notin \langle x_1, \dots, x_n \rangle$ , then we claim  $\langle x_1, \dots, x_n, f \rangle = k[x_1, \dots, x_n]$ . We leave the proof of this claim to the reader (Exercise 11 of this section). As a result, the ascending chain (1) can be continued in only two ways, either by repeating the last ideal *ad infinitum* or by appending  $k[x_1, \dots, x_n]$  and then repeating it *ad infinitum*. In either case, the ascending chain will have “stabilized” after a finite number of steps, in the sense that all the ideals after that point in the chain will be equal. Our next result shows that the same phenomenon occurs in *every* ascending chain of ideals in  $k[x_1, \dots, x_n]$ .

**Theorem 7 (The Ascending Chain Condition).** *Let*

$$I_1 \subset I_2 \subset I_3 \subset \dots$$

be an ascending chain of ideals in  $k[x_1, \dots, x_n]$ . Then there exists an  $N \geq 1$  such that

$$I_N = I_{N+1} = I_{N+2} = \dots .$$

**Proof.** Given the ascending chain  $I_1 \subset I_2 \subset I_3 \subset \dots$ , consider the set  $I = \bigcup_{i=1}^{\infty} I_i$ . We begin by showing that  $I$  is also an ideal in  $k[x_1, \dots, x_n]$ . First,  $0 \in I$  since  $0 \in I_i$  for every  $i$ . Next, if  $f, g \in I$ , then, by definition,  $f \in I_i$ , and  $g \in I_j$  for some  $i$  and  $j$  (possibly different). However, since the ideals  $I_i$  form an ascending chain, if we relabel so that  $i \leq j$ , then both  $f$  and  $g$  are in  $I_j$ . Since  $I_j$  is an ideal, the sum  $f + g \in I_j$ , hence,  $\in I$ . Similarly, if  $f \in I$  and  $r \in k[x_1, \dots, x_n]$ , then  $f \in I_i$  for some  $i$ , and  $r \cdot f \in I_i \subset I$ . Hence,  $I$  is an ideal.

By the Hilbert Basis Theorem, the ideal  $I$  must have a finite generating set:  $I = \langle f_1, \dots, f_s \rangle$ . But each of the generators is contained in some one of the  $I_j$ , say  $f_i \in I_{j_i}$  for some  $j_i, i = 1, \dots, s$ . We take  $N$  to be the maximum of the  $j_i$ . Then by the definition of an ascending chain  $f_i \in I_N$  for all  $i$ . Hence we have

$$I = \langle f_1, \dots, f_s \rangle \subset I_N \subset I_{N+1} \subset \dots \subset I.$$

As a result the ascending chain stabilizes with  $I_N$ . All the subsequent ideals in the chain are equal. □

The statement that every ascending chain of ideals in  $k[x_1, \dots, x_n]$  stabilizes is often called the **ascending chain condition**, or ACC for short. In Exercise 12 of this section, you will show that if we assume the ACC as hypothesis, then it follows that every ideal is finitely generated. Thus, the ACC is actually equivalent to the conclusion of the Hilbert Basis Theorem. We will use the ACC in a crucial way in §7, when we give Buchberger’s algorithm for constructing Groebner bases. We will also use the ACC in Chapter 4 to study the structure of affine varieties.

Our second consequence of the Hilbert Basis Theorem will be geometric. Up to this point, we have considered affine varieties as the sets of solutions of specific finite sets of polynomial equations:

$$\mathbf{V}(f_1, \dots, f_s) = \{(a_1, \dots, a_n) \in k^n : f_i(a_1, \dots, a_n) = 0 \text{ for all } i\}.$$

The Hilbert Basis Theorem shows that, in fact, it also makes sense to speak of the affine variety defined by an *ideal*  $I \subset k[x_1, \dots, x_n]$ .

**Definition 8.** Let  $I \subset k[x_1, \dots, x_n]$  be an ideal. We will denote by  $\mathbf{V}(I)$  the set

$$\mathbf{V}(I) = \{(a_1, \dots, a_n) \in k^n : f(a_1, \dots, a_n) = 0 \text{ for all } f \in I\}.$$

Even though a nonzero ideal  $I$  always contains infinitely many different polynomials, the set  $\mathbf{V}(I)$  can still be defined by a finite set of polynomial equations.

**Proposition 9.**  $\mathbf{V}(I)$  is an affine variety. In particular, if  $I = \langle f_1, \dots, f_s \rangle$ , then  $\mathbf{V}(I) = \mathbf{V}(f_1, \dots, f_s)$ .



**Proof.** By the Hilbert Basis Theorem,  $I = \langle f_1, \dots, f_s \rangle$  for some finite generating set. We claim that  $\mathbf{V}(I) = \mathbf{V}(f_1, \dots, f_s)$ . First, since the  $f_i \in I$ , if  $f(a_1, \dots, a_n) = 0$  for all  $f \in I$ , then  $f_i(a_1, \dots, a_n) = 0$ , so  $\mathbf{V}(I) \subset \mathbf{V}(f_1, \dots, f_s)$ . On the other hand, let  $(a_1, \dots, a_n) \in \mathbf{V}(f_1, \dots, f_s)$  and let  $f \in I$ . Since  $I = \langle f_1, \dots, f_s \rangle$ , we can write

$$f = \sum_{i=1}^s h_i f_i$$

for some  $h_i \in k[x_1, \dots, x_n]$ . But then

$$\begin{aligned} f(a_1, \dots, a_n) &= \sum_{i=1}^s h_i(a_1, \dots, a_n) f_i(a_1, \dots, a_n) \\ &= \sum_{i=1}^s h_i(a_1, \dots, a_n) \cdot 0 = 0. \end{aligned}$$

Thus,  $\mathbf{V}(f_1, \dots, f_s) \subset \mathbf{V}(I)$  and, hence, they are equal.  $\square$

The most important consequence of this proposition is that *varieties are determined by ideals*. For example, in Chapter 1, we proved that  $\mathbf{V}(f_1, \dots, f_s) = \mathbf{V}(g_1, \dots, g_t)$  whenever  $\langle f_1, \dots, f_s \rangle = \langle g_1, \dots, g_t \rangle$  (see Proposition 4 of Chapter 1, §4). This proposition is an immediate corollary of Proposition 9. The relation between ideals and varieties will be explored in more detail in Chapter 4.

In the exercises, we will exploit Proposition 9 by showing that by using the right generating set for an ideal  $I$ , we can gain a better understanding of the variety  $\mathbf{V}(I)$ .

### EXERCISES FOR §5

- Let  $I = \langle g_1, g_2, g_3 \rangle \subset \mathbb{R}[x, y, z]$ , where  $g_1 = xy^2 - xz + y$ ,  $g_2 = xy - z^2$  and  $g_3 = x - yz^4$ . Using the lex order, give an example of  $g \in I$  such that  $\text{LT}(g) \notin \langle \text{LT}(g_1), \text{LT}(g_2), \text{LT}(g_3) \rangle$ .
- For the ideals and generators given in Exercises 5, 6, and 7 of §3, show that  $\text{LT}(I)$  is strictly bigger than  $\langle \text{LT}(f_1), \dots, \text{LT}(f_s) \rangle$ . Hint: This should follow directly from what you did in those exercises.
- To generalize the situation of Exercises 1 and 2, suppose that  $I = \langle f_1, \dots, f_s \rangle$  is an ideal such that  $\langle \text{LT}(f_1), \dots, \text{LT}(f_s) \rangle$  is strictly smaller than  $\langle \text{LT}(I) \rangle$ .
  - Prove that there is some  $f \in I$  whose remainder on division by  $f_1, \dots, f_s$  is nonzero. Hint: First show that  $\text{LT}(f) \notin \langle \text{LT}(f_1), \dots, \text{LT}(f_s) \rangle$  for some  $f \in I$ . Then use Lemma 2 of §4.
  - What does part a say about the ideal membership problem?
  - How does part a relate to the conjecture you were asked to make in Exercise 8 of §3?
- If  $I \subset k[x_1, \dots, x_n]$  is an ideal, prove that  $\langle \text{LT}(g) : g \in I - \{0\} \rangle = \langle \text{LM}(g) : g \in I - \{0\} \rangle$ .
- Let  $I$  be an ideal of  $k[x_1, \dots, x_n]$ . Show that  $G = \{g_1, \dots, g_t\} \subset I$  is a Groebner basis of  $I$  if and only if the leading term of any element of  $I$  is divisible by one of the  $\text{LT}(g_i)$ .
- Corollary 6 asserts that a Groebner basis is a basis, i.e., if  $G = \{g_1, \dots, g_t\} \subset I$  satisfies  $\langle \text{LT}(I) \rangle = \langle \text{LT}(g_1), \dots, \text{LT}(g_t) \rangle$ , then  $I = \langle g_1, \dots, g_t \rangle$ . We gave one proof of this in the proof of Theorem 4. Complete the following sketch to give a second proof. If  $f \in I$ , then divide  $f$  by  $(g_1, \dots, g_t)$ . At each step of the division algorithm, the leading term of the polynomial under the radical will be in  $\langle \text{LT}(I) \rangle$  and, hence, will be divisible by one of the

$LT(g_i)$ . Hence, terms are never added to the remainder, so that  $f = \sum_{i=1}^l a_i g_i$  when the algorithm terminates.

7. If we use grlex order with  $x > y > z$ , is  $\{x^4y^2 - z^5, x^3y^3 - 1, x^2y^4 - 2z\}$  a Groebner basis for the ideal generated by these polynomials? Why or why not?
8. Repeat Exercise 7 for  $I = \langle x - z^2, y - z^3 \rangle$  using the lex order. Hint: The difficult part of this exercise is to determine exactly which polynomials are in  $\langle LT(I) \rangle$ .
9. Let  $A = (a_{ij})$  be an  $m \times n$  matrix with real entries in row echelon form and let  $J \subset \mathbb{R}[x_1, \dots, x_n]$  be an ideal generated by the linear polynomials  $\sum_{j=1}^n a_{ij}x_j$  for  $1 \leq i \leq m$ . Show that the given generators form a Groebner basis for  $J$  with respect to a suitable lexicographic order. Hint: Order the variables corresponding to the leading 1's before the other variables.
10. Let  $I \subset k[x_1, \dots, x_n]$  be a *principal ideal* (that is,  $I$  is generated by a single  $f \in I$ —see §5 of Chapter 1). Show that any finite subset of  $I$  containing a generator for  $I$  is a Groebner basis for  $I$ .
11. Let  $f \in k[x_1, \dots, x_n]$ . If  $f \notin \langle x_1, \dots, x_n \rangle$ , then show  $\langle x_1, \dots, x_n, f \rangle = k[x_1, \dots, x_n]$ .
12. Show that if we take as hypothesis that every ascending chain of ideals in  $k[x_1, \dots, x_n]$  stabilizes, then the conclusion of the Hilbert Basis Theorem is a consequence. Hint: Argue by contradiction, assuming that some ideal  $I \subset k[x_1, \dots, x_n]$  has no finite generating set. The arguments you gave in Exercise 12 should not make any special use of properties of polynomials. Indeed, it is true that in any commutative ring  $R$ , the following two statements are equivalent:
  - i. Every ideal  $I \subset R$  is finitely generated.
  - ii. Every ascending chain of ideals of  $R$  stabilizes.
13. Let

$$V_1 \supset V_2 \supset V_3 \supset \dots$$

be a **descending chain** of affine varieties. Show that there is some  $N \geq 1$  such that  $V_N = V_{N+1} = V_{N+2} = \dots$ . Hint: Use Exercise 14 of Chapter 1, §4.

14. Let  $f_1, f_2, \dots \in k[x_1, \dots, x_n]$  be an infinite collection of polynomials and let  $I = \langle f_1, f_2, \dots \rangle$  be the ideal they generate. Prove that there is an integer  $N$  such that  $I = \langle f_1, \dots, f_N \rangle$ . Hint: Use  $f_1, f_2, \dots$  to create an ascending chain of ideals.
15. Given polynomials  $f_1, f_2, \dots \in k[x_1, \dots, x_n]$ , let  $\mathbf{V}(f_1, f_2, \dots) \subset k^n$  be the solutions of the infinite system of equations  $f_1 = f_2 = \dots = 0$ . Show that there is some  $N$  such that  $\mathbf{V}(f_1, f_2, \dots) = \mathbf{V}(f_1, \dots, f_N)$ .
16. In Chapter 1, §4, we defined the ideal  $\mathbf{I}(V)$  of a variety  $V \subset k^n$ . In this section, we defined the variety of any ideal (see Definition 8). In particular, this means that  $\mathbf{V}(\mathbf{I}(V))$  is a variety. Prove that  $\mathbf{V}(\mathbf{I}(V)) = V$ . Hint: See the proof of Lemma 7 of Chapter 1, §4.
17. Consider the variety  $V = \mathbf{V}(x^2 - y, y + x^2 - 4) \subset \mathbb{C}^2$ . Note that  $V = \mathbf{V}(I)$ , where  $I = \langle x^2 - y, y + x^2 - 4 \rangle$ .
  - a. Prove that  $I = \langle x^2 - y, x^2 - 2 \rangle$ .
  - b. Using the basis from part a, prove that  $\mathbf{V}(I) = \{(\pm\sqrt{2}, 2)\}$ .  
One reason why the second basis made  $V$  easier to understand was that  $x^2 - 2$  could be *factored*. This implied that  $V$  “split” into two pieces. See Exercise 18 for a general statement.
18. When an ideal has a basis where some of the elements can be factored, we can use the factorization to help understand the variety.
  - a. Show that if  $g \in k[x_1, \dots, x_n]$  factors as  $g = g_1g_2$ , then for any  $f$ ,  $\mathbf{V}(f, g) = \mathbf{V}(f, g_1) \cup \mathbf{V}(f, g_2)$ .
  - b. Show that in  $\mathbb{R}^3$ ,  $\mathbf{V}(y - x^2, xz - y^2) = \mathbf{V}(y - x^2, xz - x^4)$ .
  - c. Use part a to describe and/or sketch the variety from part b.

## §6 Properties of Groebner Bases

As shown in §5, every nonzero ideal  $I \subset k[x_1, \dots, x_n]$  has a Groebner basis. In this section, we will study the properties of Groebner bases and learn how to detect when a given basis is a Groebner basis. We begin by showing that the undesirable behavior of the division algorithm in  $k[x_1, \dots, x_n]$  noted in §3 does not occur when we divide by the elements of a Groebner basis.

Let us first prove that the remainder is uniquely determined when we divide by a Groebner basis.

**Proposition 1.** *Let  $G = \{g_1, \dots, g_t\}$  be a Groebner basis for an ideal  $I \subset k[x_1, \dots, x_n]$  and let  $f \in k[x_1, \dots, x_n]$ . Then there is a unique  $r \in k[x_1, \dots, x_n]$  with the following two properties:*

- (i) *No term of  $r$  is divisible by any of  $\text{LT}(g_1), \dots, \text{LT}(g_t)$ .*
- (ii) *There is  $g \in I$  such that  $f = g + r$ .*

*In particular,  $r$  is the remainder on division of  $f$  by  $G$  no matter how the elements of  $G$  are listed when using the division algorithm.*

**Proof.** The division algorithm gives  $f = a_1g_1 + \dots + a_tg_t + r$ , where  $r$  satisfies (i). We can also satisfy (ii) by setting  $g = a_1g_1 + \dots + a_tg_t \in I$ . This proves the existence of  $r$ .

To prove uniqueness, suppose that  $f = g + r = g' + r'$  satisfy (i) and (ii). Then  $r - r' = g' - g \in I$ , so that if  $r \neq r'$ , then  $\text{LT}(r - r') \in \langle \text{LT}(I) \rangle = \langle \text{LT}(g_1), \dots, \text{LT}(g_t) \rangle$ . By Lemma 2 of §4, it follows that  $\text{LT}(r - r')$  is divisible by some  $\text{LT}(g_i)$ . This is impossible since no term of  $r, r'$  is divisible by one of  $\text{LT}(g_1), \dots, \text{LT}(g_t)$ . Thus  $r - r'$  must be zero, and uniqueness is proved.

The final part of the proposition follows from the uniqueness of  $r$ . □

The remainder  $r$  is sometimes called the *normal form* of  $f$ , and its uniqueness properties will be explored in Exercises 1 and 4. In fact, Groebner bases can be characterized by the uniqueness of the remainder—see Theorem 5.35 of BECKER and WEISPFENNING (1993) for this and other conditions equivalent to being a Groebner basis.

Although the remainder  $r$  is unique, even for a Groebner basis, the “quotients”  $a_i$  produced by the division algorithm  $f = a_1g_1 + \dots + a_tg_t + r$  can change if we list the generators in a different order. See Exercise 2 for an example.

As a corollary, we get the following criterion for when a polynomial lies in an ideal.

**Corollary 2.** *Let  $G = \{g_1, \dots, g_t\}$  be a Groebner basis for an ideal  $I \subset k[x_1, \dots, x_n]$  and let  $f \in k[x_1, \dots, x_n]$ . Then  $f \in I$  if and only if the remainder on division of  $f$  by  $G$  is zero.*

**Proof.** If the remainder is zero, then we have already observed that  $f \in I$ . Conversely, given  $f \in I$ , then  $f = f + 0$  satisfies the two conditions of Proposition 1. It follows that 0 is the remainder of  $f$  on division by  $G$ . □

The property given in Corollary 2 is sometimes taken as the definition of a Groebner basis, since one can show that it is true if and only if  $\langle \text{LT}(g_1), \dots, \text{LT}(g_r) \rangle = \langle \text{LT}(I) \rangle$  (see Exercise 3). For this and similar conditions equivalent to being a Groebner basis, see Proposition 5.38 of BECKER and WEISPFENNING (1993).

Using Corollary 2, we get an algorithm for solving the ideal membership problem from §1 *provided* that we know a Groebner basis  $G$  for the ideal in question—we only need to compute a remainder with respect to  $G$  to determine whether  $f \in I$ . In §7, we will learn how to find Groebner bases, and we will give a complete solution of the ideal membership problem in §8.

We will use the following notation for the remainder.

**Definition 3.** We will write  $\overline{f}^F$  for the remainder on division of  $f$  by the ordered  $s$ -tuple  $F = (f_1, \dots, f_s)$ . If  $F$  is a Groebner basis for  $\langle f_1, \dots, f_s \rangle$ , then we can regard  $F$  as a set (without any particular order) by Proposition 1.

For instance, with  $F = (x^2y - y^2, x^4y^2 - y^2) \subset k[x, y]$ , using the lex order, we have

$$\overline{x^5y}^F = xy^3$$

since the division algorithm yields

$$x^5y = (x^3 + xy)(x^2y - y^2) + 0 \cdot (x^4y^2 - y^2) + xy^3.$$

We next will discuss how to tell whether a given generating set of an ideal is a Groebner basis. As we have indicated, the “obstruction” to  $\{f_1, \dots, f_s\}$  being a Groebner basis is the possible occurrence of polynomial combinations of the  $f_i$  whose leading terms are not in the ideal generated by the  $\text{LT}(f_i)$ . One way this can occur is if the leading terms in a suitable combination

$$ax^\alpha f_i - bx^\beta f_j$$

cancel, leaving only smaller terms. On the other hand,  $ax^\alpha f_i - bx^\beta f_j \in I$ , so its leading term is in  $\langle \text{LT}(I) \rangle$ . You should check that this is what happened in Example 2 of §5. To study this cancellation phenomenon, we introduce the following special combinations.

**Definition 4.** Let  $f, g \in k[x_1, \dots, x_n]$  be nonzero polynomials.

- (i) If  $\text{multideg}(f) = \alpha$  and  $\text{multideg}(g) = \beta$ , then let  $\gamma = (\gamma_1, \dots, \gamma_n)$ , where  $\gamma_i = \max(\alpha_i, \beta_i)$  for each  $i$ . We call  $x^\gamma$  the **least common multiple** of  $\text{LM}(f)$  and  $\text{LM}(g)$ , written  $x^\gamma = \text{LCM}(\text{LM}(f), \text{LM}(g))$ .
- (ii) The **S-polynomial** of  $f$  and  $g$  is the combination

$$S(f, g) = \frac{x^\gamma}{\text{LT}(f)} \cdot f - \frac{x^\gamma}{\text{LT}(g)} \cdot g.$$

(Note that we are inverting the leading coefficients here as well.)

For example, let  $f = x^3y^2 - x^2y^3 + x$  and  $g = 3x^4y + y^2$  in  $\mathbb{R}[x, y]$  with the grlex order. Then  $\gamma = (4, 2)$  and

$$\begin{aligned} S(f, g) &= \frac{x^4y^2}{x^3y^2} \cdot f - \frac{x^4y^2}{3x^4y} \cdot g \\ &= x \cdot f - (1/3) \cdot y \cdot g \\ &= -x^3y^3 + x^2 - (1/3)y^3. \end{aligned}$$

An S-polynomial  $S(f, g)$  is “designed” to produce cancellation of leading terms. In fact, the following lemma shows that every cancellation of leading terms among polynomials of the same multidegree results from this sort of cancellation.

**Lemma 5.** *Suppose we have a sum  $\sum_{i=1}^s c_i f_i$ , where  $c_i \in k$  and  $\text{multideg}(f_i) = \delta \in \mathbb{Z}_{\geq 0}^n$  for all  $i$ . If  $\text{multideg}(\sum_{i=1}^s c_i f_i) < \delta$ , then  $\sum_{i=1}^s c_i f_i$  is a linear combination, with coefficients in  $k$ , of the S-polynomials  $S(f_j, f_k)$  for  $1 \leq j, k \leq s$ . Furthermore, each  $S(f_i, f_k)$  has multidegree  $< \delta$ .*

**Proof.** Let  $d_i = \text{LC}(f_i)$ , so that  $c_i d_i$  is the leading coefficient of  $c_i f_i$ . Since the  $c_i f_i$  all have multidegree  $\delta$  and their sum has strictly smaller multidegree, it follows easily that  $\sum_{i=1}^s c_i d_i = 0$ .

Define  $p_i = f_i/d_i$ , and note that  $p_i$  has leading coefficient 1. Consider the telescoping sum

$$\begin{aligned} \sum_{i=1}^s c_i f_i &= \sum_{i=1}^s c_i d_i p_i = c_1 d_1 (p_1 - p_2) + (c_1 d_1 + c_2 d_2)(p_2 - p_3) + \cdots + \\ &\quad (c_1 d_1 + \cdots + c_{s-1} d_{s-1})(p_{s-1} - p_s) + (c_1 d_1 + \cdots + c_s d_s) p_s. \end{aligned}$$

By assumption,  $\text{LT}(f_i) = d_i x^\delta$ , which implies that the least common multiple of  $\text{LM}(f_j)$  and  $\text{LM}(f_k)$  is  $x^\delta$ . Thus

$$(1) \quad S(f_j, f_k) = \frac{x^\delta}{\text{LT}(f_j)} f_j - \frac{x^\delta}{\text{LT}(f_k)} f_k = \frac{x^\delta}{d_j x^\delta} f_j - \frac{x^\delta}{d_k x^\delta} f_k = p_j - p_k.$$

Using this equation and  $\sum_{i=1}^s c_i d_i = 0$ , the above telescoping sum becomes

$$\begin{aligned} \sum_{i=1}^s c_i f_i &= c_1 d_1 S(f_1, f_2) + (c_1 d_1 + c_2 d_2) S(f_2, f_3) \\ &\quad + \cdots + (c_1 d_1 + \cdots + c_{s-1} d_{s-1}) S(f_{s-1}, f_s), \end{aligned}$$

which is a sum of the desired form. Since  $p_j$  and  $p_k$  have multidegree  $\delta$  and leading coefficient 1, the difference  $p_j - p_k$  has multidegree  $< \delta$ . By equation (1), the same is true of  $S(f_j, f_k)$ , and the lemma is proved.  $\square$

When  $f_1, \dots, f_s$  satisfy the hypothesis of Lemma 5, we get an equation of the form

$$\sum_{i=1}^s c_i f_i = \sum_{j,k} c_{jk} S(f_j, f_k).$$

Let us consider where the cancellation occurs. In the sum on the left, every summand  $c_i f_i$  has multidegree  $\delta$ , so the cancellation occurs only after adding them up. However, in the sum on the right, each summand  $c_{jk} S(f_j, f_k)$  has multidegree  $< \delta$ , so that the cancellation has already occurred. Intuitively, this means that all cancellation can be accounted for by S-polynomials.

Using S-polynomials and Lemma 5, we can now prove the following criterion of Buchberger for when a basis of an ideal is a Groebner basis.

**Theorem 6 (Buchberger’s Criterion).** *Let  $I$  be a polynomial ideal. Then a basis  $G = \{g_1, \dots, g_t\}$  for  $I$  is a Groebner basis for  $I$  if and only if for all pairs  $i \neq j$ , the remainder on division of  $S(g_i, g_j)$  by  $G$  (listed in some order) is zero.*

**Proof.**  $\Rightarrow$ : If  $G$  is a Groebner basis, then since  $S(g_i, g_j) \in I$ , the remainder on division by  $G$  is zero by Corollary 2.

$\Leftarrow$ : Let  $f \in I$  be a nonzero polynomial. We must show that if the S-polynomials all have zero remainders on division by  $G$ , then  $LT(f) \in \langle LT(g_1), \dots, LT(g_t) \rangle$ . Before giving the details, let us outline the strategy of the proof.

Given  $f \in I = \langle g_1, \dots, g_t \rangle$ , there are polynomials  $h_i \in k[x_1, \dots, x_n]$  such that

$$(2) \quad f = \sum_{i=1}^t h_i g_i.$$

From Lemma 8 of §2, it follows that

$$(3) \quad \text{multideg}(f) \leq \max(\text{multideg}(h_i g_i)).$$

If equality does not occur, then some cancellation must occur among the leading terms of (2). Lemma 5 will enable us to rewrite this in terms of S-polynomials. Then our assumption that S-polynomials have zero remainders will allow us to replace the S-polynomials by expressions that involve less cancellation. Thus, we will get an expression for  $f$  that has less cancellation of leading terms. Continuing in this way, we will eventually find an expression (2) for  $f$  where equality occurs in (3). Then  $\text{multideg}(f) = \text{multideg}(h_i g_i)$  for some  $i$ , and it will follow that  $LT(f)$  is divisible by  $LT(g_i)$ . This will show that  $LT(f) \in \langle LT(g_1), \dots, LT(g_t) \rangle$ , which is what we want to prove.

We now give the details of the proof. Given an expression (2) for  $f$ , let  $m(i) = \text{multideg}(h_i g_i)$ , and define  $\delta = \max(m(1), \dots, m(t))$ . Then inequality (3) becomes

$$\text{multideg}(f) \leq \delta.$$

Now consider *all* possible ways that  $f$  can be written in the form (2). For each such expression, we get a possibly different  $\delta$ . Since a monomial order is a well-ordering, we can select an expression (2) for  $f$  such that  $\delta$  is *minimal*.

We will show that once this minimal  $\delta$  is chosen, we have  $\text{multideg}(f) = \delta$ . Then equality occurs in (3), and as we observed, it follows that  $LT(f) \in \langle LT(g_1), \dots, LT(g_t) \rangle$ . This will prove the theorem.

It remains to show  $\text{multideg}(f) = \delta$ . We will prove this by contradiction. Equality can fail only when  $\text{multideg}(f) < \delta$ . To isolate the terms of multidegree  $\delta$ , let us write

$f$  in the following form:

$$(4) \quad \begin{aligned} f &= \sum_{m(i)=\delta} h_i g_i + \sum_{m(i)<\delta} h_i g_i \\ &= \sum_{m(i)=\delta} \text{LT}(h_i) g_i + \sum_{m(i)=\delta} (h_i - \text{LT}(h_i)) g_i + \sum_{m(i)<\delta} h_i g_i \end{aligned}$$

The monomials appearing in the second and third sums on the second line all have multidegree  $< \delta$ . Thus, the assumption  $\text{multideg}(f) < \delta$  means that the first sum also has multidegree  $< \delta$ .

Let  $\text{LT}(h_i) = c_i x^{\alpha(i)}$ . Then the first sum  $\sum_{m(i)=\delta} \text{LT}(h_i) g_i = \sum_{m(i)=\delta} c_i x^{\alpha(i)} g_i$  has exactly the form described in Lemma 5 with  $f_i = x^{\alpha(i)} g_i$ . Thus Lemma 5 implies that this sum is a linear combination of the S-polynomials  $S(x^{\alpha(j)} g_j, x^{\alpha(k)} g_k)$ . However,

$$\begin{aligned} S(x^{\alpha(j)} g_j, x^{\alpha(k)} g_k) &= \frac{x^\delta}{x^{\alpha(j)} \text{LT}(g_j)} x^{\alpha(j)} g_j - \frac{x^\delta}{x^{\alpha(k)} \text{LT}(g_k)} x^{\alpha(k)} g_k \\ &= x^{\delta-\gamma_{jk}} S(g_j, g_k), \end{aligned}$$

where  $x^{\gamma_{jk}} = \text{LCM}(\text{LM}(g_j), \text{LM}(g_k))$ . Thus there are constants  $c_{jk} \in k$  such that

$$(5) \quad \sum_{m(i)=\delta} \text{LT}(h_i) g_i = \sum_{j,k} c_{jk} x^{\delta-\gamma_{jk}} S(g_j, g_k).$$

The next step is to use our hypothesis that the remainder of  $S(g_j, g_k)$  on division by  $g_1, \dots, g_t$  is zero. Using the division algorithm, this means that each S-polynomial can be written in the form

$$(6) \quad S(g_j, g_k) = \sum_{i=1}^t a_{ijk} g_i,$$

where  $a_{ijk} \in k[x_1, \dots, x_n]$ . The division algorithm also tells us that

$$(7) \quad \text{multideg}(a_{ijk} g_i) \leq \text{multideg}(S(g_j, g_k))$$

for all  $i, j, k$  (see Theorem 3 of §3). Intuitively, this says that when the remainder is zero, we can find an expression for  $S(g_j, g_k)$  in terms of  $G$  where the leading terms do not all cancel.

To exploit this, multiply the expression for  $S(g_j, g_k)$  by  $x^{\delta-\gamma_{jk}}$  to obtain

$$x^{\delta-\gamma_{jk}} S(g_j, g_k) = \sum_{i=1}^t b_{ijk} g_i,$$

where  $b_{ijk} = x^{\delta-\gamma_{jk}} a_{ijk}$ . Then (7) and Lemma 5 imply that

$$(8) \quad \text{multideg}(b_{ijk} g_i) \leq \text{multideg}(x^{\delta-\gamma_{jk}} S(g_j, g_k)) < \delta.$$

If we substitute the above expression for  $x^{\delta-\gamma_{jk}} S(g_j, g_k)$  into (5), we get an equation

$$\sum_{m(i)=\delta} \text{LT}(h_i) g_i = \sum_{j,k} c_{jk} x^{\delta-\gamma_{jk}} S(g_j, g_k) = \sum_{j,k} c_{jk} \left( \sum_i b_{ijk} g_i \right) = \sum_i \tilde{h}_i g_i$$

which by (8) has the property that for all  $i$ ,

$$\text{multideg}(\tilde{h}_i g_i) < \delta.$$

For the final step in the proof, substitute  $\sum_{m(i)=\delta} \text{LT}(h_i) g_i = \sum_i \tilde{h}_i g_i$  into equation (4) to obtain an expression for  $f$  as a polynomial combination of the  $g_i$ 's where *all* terms have multidegree  $< \delta$ . This contradicts the minimality of  $\delta$  and completes the proof of the theorem.  $\square$

The Buchberger Criterion given in Theorem 6 is one of the key results about Groebner bases. We have seen that Groebner bases have many nice properties, but, so far, it has been difficult to determine if a basis of an ideal is a Groebner basis (the examples we gave in §5 were rather trivial). Using the S-pair criterion, however, it is now easy to show whether a given basis is a Groebner basis. Furthermore, in §7, we will see that the S-pair criterion also leads naturally to an algorithm for computing Groebner bases.

As an example of how to use Theorem 6, consider the ideal  $I = \langle y - x^2, z - x^3 \rangle$  of the twisted cubic in  $\mathbb{R}^3$ . We claim that  $G = \{y - x^2, z - x^3\}$  is a Groebner basis for lex order with  $y > z > x$ . To prove this, consider the S-polynomial

$$S(y - x^2, z - x^3) = \frac{yz}{y}(y - x^2) - \frac{yz}{z}(z - x^3) = -zx^2 + yx^3.$$

Using the division algorithm, one finds

$$-zx^2 + yx^3 = x^3 \cdot (y - x^2) + (-x^2) \cdot (z - x^3) + 0,$$

so that  $S(y - x^2, z - x^3)^G = 0$ . Thus, by Theorem 6,  $G$  is a Groebner basis for  $I$ . You can also check that  $G$  is *not* a Groebner basis for lex order with  $x > y > z$  (see Exercise 8).

**EXERCISES FOR §6**

1. Show that Proposition 1 can be strengthened slightly as follows. Fix a monomial ordering and let  $I \subset k[x_1, \dots, x_n]$  be an ideal. Suppose that  $f \in k[x_1, \dots, x_n]$ .
  - a. Show that  $f$  can be written in the form  $f = g + r$ , where  $g \in I$  and no term of  $r$  is divisible by any element of  $\text{LT}(I)$ .
  - b. Given two expressions  $f = g + r = g' + r'$  as in part (a), prove that  $r = r'$ . Thus,  $r$  is uniquely determined.

This result shows once a monomial order is fixed, we can define a unique “remainder of  $f$  on division by  $I$ .” We will exploit this idea in Chapter 5.

2. In §5, we showed that  $G = \{x + z, y - z\}$  is a Groebner basis for lex order. Let us use this basis to study the uniqueness of the division algorithm.
  - a. Divide  $xy$  by  $x + z, y - z$ .
  - b. Now reverse the order and divide  $xy$  by  $y - z, x + z$ .  
You should get the same remainder (as predicted by Proposition 1), but the “quotients” should be different for the two divisions. This shows that the uniqueness of the remainder is the best one can hope for.
3. In Corollary 2, we showed that if  $I = \langle g_1, \dots, g_t \rangle$  and if  $G = \{g_1, \dots, g_t\}$  is a Groebner basis for  $I$ , then  $\bar{f}^G = 0$  for all  $f \in I$ . Prove the converse of this statement. Namely, show that if  $G$  is a basis for  $I$  with the property that  $\bar{f}^G = 0$  for all  $f \in I$ , then  $G$  is a Groebner basis for  $I$ .



4. Let  $G$  and  $G'$  be Groebner bases for an ideal  $I$  with respect to the same monomial order in  $k[x_1, \dots, x_n]$ . Show that  $\overline{f}^G = \overline{f}^{G'}$  for all  $f \in k[x_1, \dots, x_n]$ . Hence, the remainder on division by a Groebner basis is even independent of which Groebner basis we use, as long as we use one particular monomial order. Hint: See Exercise 1.
5. Compute  $S(f, g)$  using the lex order.
  - a.  $f = 4x^2z - 7y^2, \quad g = xyz^2 + 3xz^4$ .
  - b.  $f = x^4y - z^2, \quad g = 3xz^2 - y$ .
  - c.  $f = x^7y^2z + 2ixyz, \quad g = 2x^7y^2z + 4$ .
  - d.  $f = xy + z^3, \quad g = z^2 - 3z$ .
6. Does  $S(f, g)$  depend on which monomial order is used? Illustrate your assertion with examples.
7. Prove that  $\text{multideg}(S(f, g)) < \gamma$ , where  $x^\gamma = \text{LCM}(\text{LM}(f), \text{LM}(g))$ . Explain why this inequality is a precise version of the claim that S-polynomials are designed to produce cancellation.
8. Show that  $\{y - x^2, z - x^3\}$  is not a Groebner basis for lex order with  $x > y > z$ .
9. Using Theorem 6, determine whether the following sets  $G$  are Groebner bases for the ideal they generate. You may want to use a computer algebra system to compute the S-polynomials and remainders.
  - a.  $G = \{x^2 - y, x^3 - z\}$  grlex order.
  - b.  $G = \{x^2 - y, x^3 - z\}$  invlex order (see Exercise 6 of §2).
  - c.  $G = \{xy^2 - xz + y, xy - z^2, x - yz^4\}$  lex order.
10. Let  $f, g \in k[x_1, \dots, x_n]$  be polynomials such that  $\text{LM}(f)$  and  $\text{LM}(g)$  are *relatively prime* monomials and  $\text{LC}(f) = \text{LC}(g) = 1$ . Assume that  $f$  or  $g$  has at least two terms.
  - a. Show that  $S(f, g) = -(g - \text{LT}(g))f + (f - \text{LT}(f))g$ .
  - b. Deduce that  $S(f, g) \neq 0$  and that the leading monomial of  $S(f, g)$  is a multiple of either  $\text{LM}(f)$  or  $\text{LM}(g)$  in this case.
11. Let  $f, g \in k[x_1, \dots, x_n]$  and  $x^\alpha, x^\beta$  be monomials. Verify that

$$S(x^\alpha f, x^\beta g) = x^\gamma S(f, g)$$

where

$$x^\gamma = \frac{\text{LCM}(x^\alpha \text{LM}(f), x^\beta \text{LM}(g))}{\text{LCM}(\text{LM}(f), \text{LM}(g))}.$$

Be sure to prove that  $x^\gamma$  is a monomial.

12. Let  $I \subset k[x_1, \dots, x_n]$  be an ideal, and let  $G$  be a Groebner basis of  $I$ .
  - a. Show that  $\overline{f}^G = \overline{g}^G$  if and only if  $f - g \in I$ . Hint: See Exercise 1.
  - b. Deduce that

$$\overline{f+g}^G = \overline{f}^G + \overline{g}^G.$$

Hint: Use Exercise 1.

- c. Deduce that

$$\overline{fg}^G = \overline{\overline{f}^G \cdot \overline{g}^G}^G.$$

We will return to an interesting consequence of these facts in Chapter 5.

## §7 Buchberger's Algorithm

In Corollary 6 of §5, we saw that every ideal in  $k[x_1, \dots, x_n]$  other than 0 has a Groebner basis. Unfortunately, the proof given was nonconstructive in the sense that it did not

tell us how to produce the Groebner basis. So we now turn to the question: given an ideal  $I \subset k[x_1, \dots, x_n]$ , how can we actually construct a Groebner basis for  $I$ ? To see the main ideas behind the method we will use, we return to the ideal of Example 2 from §5 and proceed as follows.

**Example 1.** Consider the ring  $k[x, y]$  with grlex order, and let  $I = \langle f_1, f_2 \rangle = \langle x^3 - 2xy, x^2y - 2y^2 + x \rangle$ . Recall that  $\{f_1, f_2\}$  is not a Groebner basis for  $I$  since  $\text{LT}(S(f_1, f_2)) = -x^2 \notin \langle \text{LT}(f_1), \text{LT}(f_2) \rangle$ .

To produce a Groebner basis, one natural idea is to try first to extend the original generating set to a Groebner basis by adding more polynomials in  $I$ . In one sense, this adds nothing new, and even introduces an element of redundancy. However, the extra information we get from a Groebner basis more than makes up for this.

What new generators should we add? By what we have said about the S-polynomials in §6, the following should come as no surprise. We have  $S(f_1, f_2) = -x^2 \in I$ , and its remainder on division by  $F = (f_1, f_2)$  is  $-x^2$ , which is nonzero. Hence, we should include that remainder in our generating set, as a new generator  $f_3 = -x^2$ . If we set  $F = (f_1, f_2, f_3)$ , we can use Theorem 6 of §6 to test if this new set is a Groebner basis for  $I$ . We compute

$$\begin{aligned} S(f_1, f_2) &= f_3, \text{ so} \\ \overline{S(f_1, f_2)}^F &= 0, \\ S(f_1, f_3) &= (x^3 - 2xy) - (-x)(-x^2) = -2xy, \text{ but} \\ \overline{S(f_1, f_3)}^F &= -2xy \neq 0. \end{aligned}$$

Hence, we must add  $f_4 = -2xy$  to our generating set. If we let  $F = (f_1, f_2, f_3, f_4)$ , then by Exercise 12 we have

$$\begin{aligned} \overline{S(f_1, f_2)}^F &= \overline{S(f_1, f_3)}^F = 0, \\ S(f_1, f_4) &= y(x^3 - 2xy) - (-1/2)x^2(-2xy) = -2xy^2 = yf_4, \text{ so} \\ \overline{S(f_1, f_4)}^F &= 0, \\ S(f_2, f_3) &= (x^2y - 2y^2 + x) - (-y)(-x^2) = -2y^2 + x, \text{ but} \\ \overline{S(f_2, f_3)}^F &= -2y^2 + x \neq 0. \end{aligned}$$

Thus, we must also add  $f_5 = -2y^2 + x$  to our generating set. Setting  $F = \{f_1, f_2, f_3, f_4, f_5\}$ , one can compute that

$$\overline{S(f_i, f_j)}^F = 0 \text{ for all } 1 \leq i \leq j \leq 5.$$

By Theorem 6 of §6, it follows that a grlex Groebner basis for  $I$  is given by

$$\{f_1, f_2, f_3, f_4, f_5\} = \{x^3 - 2xy, x^2y - 2y^2 + x, -x^2, -2xy, -2y^2 + x\}.$$

The above example suggests that in general, one should try to extend a basis  $F$  to a Groebner basis by successively adding nonzero remainders  $\overline{S(f_i, f_j)}^F$  to  $F$ . This idea is a natural consequence of the S-pair criterion from §6 and leads to the following algorithm due to Buchberger for computing a Groebner basis.

**Theorem 2 (Buchberger's Algorithm).** *Let  $I = \langle f_1, \dots, f_s \rangle \neq \{0\}$  be a polynomial ideal. Then a Groebner basis for  $I$  can be constructed in a finite number of steps by the following algorithm:*

Input:  $F = (f_1, \dots, f_s)$

Output: a Groebner basis  $G = (g_1, \dots, g_t)$  for  $I$ , with  $F \subset G$

$G := F$

REPEAT

$G' := G$

FOR each pair  $\{p, q\}$ ,  $p \neq q$  in  $G'$  DO

$S := \overline{S(p, q)}^{G'}$

IF  $S \neq 0$  THEN  $G := G \cup \{S\}$

UNTIL  $G = G'$

**Proof.** We begin with some frequently used notation. If  $G = \{g_1, \dots, g_t\}$ , then  $\langle G \rangle$  and  $\langle \text{LT}(G) \rangle$  will denote the following ideals:

$$\begin{aligned} \langle G \rangle &= \langle g_1, \dots, g_t \rangle \\ \langle \text{LT}(G) \rangle &= \langle \text{LT}(g_1), \dots, \text{LT}(g_t) \rangle. \end{aligned}$$

Turning to the proof of the theorem, we first show that  $G \subset I$  holds at every stage of the algorithm. This is true initially, and whenever we enlarge  $G$ , we do so by adding the remainder  $S = \overline{S(p, q)}^{G'}$  for  $p, q \in G$ . Thus, if  $G \subset I$ , then  $p, q$  and, hence,  $S(p, q)$  are in  $I$ , and since we are dividing by  $G' \subset I$ , we get  $G \cup \{S\} \subset I$ . We also note that  $G$  contains the given basis  $F$  of  $I$  so that  $G$  is actually a basis of  $I$ .

The algorithm terminates when  $G = G'$ , which means that  $S = \overline{S(p, q)}^{G'} = 0$  for all  $p, q \in G$ . Hence  $G$  is a Groebner basis of  $\langle G \rangle = I$  by Theorem 6 of §6.

It remains to prove that the algorithm terminates. We need to consider what happens after each pass through the main loop. The set  $G$  consists of  $G'$  (the old  $G$ ) together with the nonzero remainders of  $S$ -polynomials of elements of  $G'$ . Then

$$(1) \quad \langle \text{LT}(G') \rangle \subset \langle \text{LT}(G) \rangle$$

since  $G' \subset G$ . Furthermore, if  $G' \neq G$ , we claim that  $\langle \text{LT}(G') \rangle$  is strictly smaller than  $\langle \text{LT}(G) \rangle$ . To see this, suppose that a nonzero remainder  $r$  of an  $S$ -polynomial has been adjoined to  $G$ . Since  $r$  is a remainder on division by  $G'$ ,  $\text{LT}(r)$  is not divisible by the leading terms of elements of  $G'$ , and thus  $\text{LT}(r) \notin \langle \text{LT}(G') \rangle$ . Yet  $\text{LT}(r) \in \langle \text{LT}(G) \rangle$ , which proves our claim.

By (1), the ideals  $\langle \text{LT}(G') \rangle$  from successive iterations of the loop form an ascending chain of ideals in  $k[x_1, \dots, x_n]$ . Thus, the ACC (Theorem 7 of §5) implies that after a finite number of iterations the chain will stabilize, so that  $\langle \text{LT}(G') \rangle = \langle \text{LT}(G) \rangle$  must happen eventually. By the previous paragraph, this implies that  $G' = G$ , so that the algorithm must terminate after a finite number of steps.  $\square$

Taken together, the Buchberger criterion (Theorem 6 of §6) and the Buchberger algorithm (Theorem 2 above) provide an algorithmic basis for the theory of Groebner bases. These contributions of Buchberger are central to the development of the subject. In §8, we will get our first hints of what can be done with these methods, and a large part of the rest of the book will be devoted to exploring their ramifications.

We should also point out the algorithm presented in Theorem 2 is only a rudimentary version of the Buchberger algorithm. It was chosen for what we hope will be its clarity for the reader, but it is not a very practical way to do the computation. Note (as a first improvement) that once a remainder  $\overline{S(p, q)}^{G'} = 0$ , that remainder will stay zero even if we adjoin further elements to the generating set  $G'$ . Thus, there is no reason to recompute those remainders on subsequent passes through the main loop. Indeed, if we add our new generators  $f_j$  one at a time, the only remainders that need to be checked are  $\overline{S(f_i, f_j)}^{G'}$ , where  $i \leq j - 1$ . It is a good exercise to revise the algorithm to take this observation into account. Other improvements of a deeper nature can also be made, but we will postpone considering them until §9.

Groebner bases computed using the algorithm of Theorem 2 are often bigger than necessary. We can eliminate some unneeded generators by using the following fact.

**Lemma 3.** *Let  $G$  be a Groebner basis for the polynomial ideal  $I$ . Let  $p \in G$  be a polynomial such that  $\text{LT}(p) \in \langle \text{LT}(G - \{p\}) \rangle$ . Then  $G - \{p\}$  is also a Groebner basis for  $I$ .*

**Proof.** We know that  $\langle \text{LT}(G) \rangle = \langle \text{LT}(I) \rangle$ . If  $\text{LT}(p) \in \langle \text{LT}(G - \{p\}) \rangle$ , then we have  $\langle \text{LT}(G - \{p\}) \rangle = \langle \text{LT}(G) \rangle$ . By definition, it follows that  $G - \{p\}$  is also a Groebner basis for  $I$ .  $\square$

By adjusting constants to make all leading coefficients 1 and removing any  $p$  with  $\text{LT}(p) \in \langle \text{LT}(G - \{p\}) \rangle$  from  $G$ , we arrive at what we will call a **minimal** Groebner basis.

**Definition 4.** *A minimal Groebner basis for a polynomial ideal  $I$  is a Groebner basis  $G$  for  $I$  such that:*

- (i)  $\text{LC}(p) = 1$  for all  $p \in G$ .
- (ii) For all  $p \in G$ ,  $\text{LT}(p) \notin \langle \text{LT}(G - \{p\}) \rangle$ .

We can construct a minimal Groebner basis for a given nonzero ideal by applying the algorithm of Theorem 2 and then using Lemma 3 to eliminate any unneeded generators that might have been included. To illustrate this procedure, we return once again to the ideal  $I$  studied in Example 1. Using grlex order, we found the Groebner basis

$$\begin{aligned} f_1 &= x^3 - 2xy, \\ f_2 &= x^2y - 2y^2 + x, \\ f_3 &= -x^2, \\ f_4 &= -2xy, \\ f_5 &= -2y^2 + x. \end{aligned}$$

Since some of the leading coefficients are different from 1, the first step is to multiply the generators by suitable constants to make this true. Then note that  $\text{LT}(f_1) = x^3 = -x \cdot \text{LT}(f_3)$ . By Lemma 3, we can dispense with  $f_1$  in the minimal Groebner basis. Similarly, since  $\text{LT}(f_2) = x^2y = -(1/2)x \cdot \text{LT}(f_4)$ , we can also eliminate  $f_2$ . There are no further cases where the leading term of a generator divides the leading term of another generator. Hence,

$$\tilde{f}_3 = x^2, \quad \tilde{f}_4 = xy, \quad \tilde{f}_5 = y^2 - (1/2)x$$

is a minimal Groebner basis for  $I$ .

Unfortunately, a given ideal may have many minimal Groebner bases. For example, in the ideal  $I$  considered above, it is easy to check that

$$(2) \quad \hat{f}_3 = x^2 + axy, \quad \tilde{f}_4 = xy, \quad \tilde{f}_5 = y^2 - (1/2)x$$

is also a minimal Groebner basis, where  $a \in k$  is any constant. Thus, we can produce infinitely many minimal Groebner bases (assuming  $k$  is infinite). Fortunately, we can single out one minimal basis that is better than the others. The definition is as follows.

**Definition 5.** A **reduced Groebner basis** for a polynomial ideal  $I$  is a Groebner basis  $G$  for  $I$  such that:

- (i)  $\text{LC}(p) = 1$  for all  $p \in G$ .
- (ii) For all  $p \in G$ , no monomial of  $p$  lies in  $\langle \text{LT}(G - \{p\}) \rangle$ .

Note that for the Groebner bases given in (2), only the one with  $a = 0$  is reduced. In general, reduced Groebner bases have the following nice property.

**Proposition 6.** Let  $I \neq \{0\}$  be a polynomial ideal. Then, for a given monomial ordering,  $I$  has a unique reduced Groebner basis.

**Proof.** Let  $G$  be a minimal Groebner basis for  $I$ . We say that  $g \in G$  is *reduced for  $G$*  provided that no monomial of  $g$  is in  $\langle \text{LT}(G - \{g\}) \rangle$ . Our goal is to modify  $G$  until all of its elements are reduced.

A first observation is that if  $g$  is reduced for  $G$ , then  $g$  is also reduced for any other minimal Groebner basis of  $I$  that contains  $g$  and has the same set of leading terms. This follows because the definition of reduced only involves the leading terms.

Next, given  $g \in G$ , let  $g' = \bar{g}^{G-\{g\}}$  and set  $G' = (G - \{g\}) \cup \{g'\}$ . We claim that  $G'$  is a minimal Groebner basis for  $I$ . To see this, first note that  $\text{LT}(g') = \text{LT}(g)$ , for when we divide  $g$  by  $G - \{g\}$ ,  $\text{LT}(g)$  goes to the remainder since it is not divisible by any element of  $\text{LT}(G - \{g\})$ . This shows that  $\langle \text{LT}(G') \rangle = \langle \text{LT}(G) \rangle$ . Since  $G'$  is clearly contained in  $I$ , we see that  $G'$  is a Groebner basis, and minimality follows. Finally, note that  $g'$  is reduced for  $G'$  by construction.

Now, take the elements of  $G$  and apply the above process until they are all reduced. The Groebner basis may change each time we do the process, but our earlier observation shows that once an element is reduced, it stays reduced since we never change the leading terms. Thus, we end up with a reduced Groebner basis.

Finally, to prove uniqueness, suppose that  $G$  and  $\tilde{G}$  are reduced Groebner bases for  $I$ . Then in particular,  $G$  and  $\tilde{G}$  are minimal Groebner bases, and in Exercise 7, we will show that this implies they have the same leading terms, i.e.,

$$\text{LT}(G) = \text{LT}(\tilde{G}).$$

Thus, given  $g \in G$ , there is  $\tilde{g} \in \tilde{G}$  such that  $\text{LT}(g) = \text{LT}(\tilde{g})$ . If we can show that  $g = \tilde{g}$ , it will follow that  $G = \tilde{G}$ , and uniqueness will be proved.

To show  $g = \tilde{g}$ , consider  $g - \tilde{g}$ . This is in  $I$ , and since  $G$  is a Groebner basis, it follows that  $\overline{g - \tilde{g}}^G = 0$ . But we also know  $\text{LT}(g) = \text{LT}(\tilde{g})$ . Hence, these terms cancel in  $g - \tilde{g}$ , and the remaining terms are divisible by none of  $\text{LT}(G) = \text{LT}(\tilde{G})$  since  $G$  and  $\tilde{G}$  are reduced. This shows that  $\overline{g - \tilde{g}}^G = g - \tilde{g}$ , and then  $g - \tilde{g} = 0$  follows. This completes the proof.  $\square$

Many computer algebra systems implement a version of Buchberger's algorithm for computing Groebner bases. These systems always compute a Groebner basis whose elements are constant multiples of the elements in a reduced Groebner basis. This means that they will give essentially the same answers for a given problem. Thus, answers can be easily checked from one system to the next.

Another consequence of the uniqueness in Proposition 6 is that we have an **ideal equality algorithm** for seeing when two sets of polynomials  $\{f_1, \dots, f_s\}$  and  $\{g_1, \dots, g_t\}$  generate the same ideal: simply fix a monomial order and compute a reduced Groebner basis for  $\langle f_1, \dots, f_s \rangle$  and  $\langle g_1, \dots, g_t \rangle$ . Then the ideals are equal if and only if the Groebner bases are the same.

To conclude this section, we will indicate briefly some of the connections between Buchberger's algorithm and the row-reduction (Gaussian elimination) algorithm for systems of linear equations. The interesting fact here is that the row-reduction algorithm is essentially a special case of the general algorithm we have discussed. For concreteness, we will discuss the special case corresponding to the system of linear equations

$$\begin{array}{cccccc} 3x & - & 6y & - & 2z & & = & 0, \\ 2x & - & 4y & & & + & 4w & = & 0, \\ x & - & 2y & - & z & - & w & = & 0. \end{array}$$

If we use row operations on the coefficient matrix to put it in row echelon form (which means that the leading 1's have been identified), then we get the matrix

$$(3) \quad \begin{pmatrix} 1 & -2 & -1 & -1 \\ 0 & 0 & 1 & 3 \\ 0 & 0 & 0 & 0 \end{pmatrix}.$$

To get a *reduced* row echelon matrix, we need to make sure that each leading 1 is the only nonzero entry in its column. This leads to the matrix

$$(4) \quad \begin{pmatrix} 1 & -2 & 0 & 2 \\ 0 & 0 & 1 & 3 \\ 0 & 0 & 0 & 0 \end{pmatrix}.$$

To translate these computations into algebra, let  $I$  be the ideal

$$I = \langle 3x - 6y - 2z, 2x - 4y + 4w, x - 2y - z - w \rangle \subset k[x, y, z, w]$$

corresponding to the original system of equations. We will use lex order with  $x > y > z > w$ . Then, in the exercises, you will verify that the linear forms determined by the row echelon matrix (3) give a minimal Groebner basis

$$I = \langle x - 2y - z - w, z + 3w \rangle,$$

and you will also check that the reduced row echelon matrix (4) gives the reduced Groebner basis

$$I = \langle x - 2y + 2w, z + 3w \rangle.$$

Recall from linear algebra that every matrix can be put in reduced row echelon form in a unique way. This can be viewed as a special case of the uniqueness of reduced Groebner bases.

In the exercises, you will also examine the relation between Buchberger's algorithm and the Euclidean Algorithm for finding the generator for the ideal  $\langle f, g \rangle \subset k[x]$ .

### EXERCISES FOR §7

1. Check that  $\overline{S(f_i, f_j)}^F = 0$  for all pairs  $1 \leq i < j \leq 5$  in Example 1.
2. Use the algorithm given in Theorem 2 to find a Groebner basis for each of the following ideals. You may wish to use a computer algebra system to compute the S-polynomials and remainders. Use the lex, then the grlex order in each case, and then compare your results.
  - a.  $I = \langle x^2y - 1, xy^2 - x \rangle$ .
  - b.  $I = \langle x^2 + y, x^4 + 2x^2y + y^2 + 3 \rangle$ . [What does your result indicate about the variety  $\mathbf{V}(I)$ ?]
  - c.  $I = \langle x - z^4, y - z^5 \rangle$ .
3. Find reduced Groebner bases for the ideals in Exercise 2 with respect to the lex and the grlex orders.
4. Use the result of Exercise 7 of §4 to give an alternate proof that Buchberger's algorithm will always terminate after a finite number of steps.
5. Let  $G$  be a Groebner basis of an ideal  $I$  with the property that  $\text{LC}(g) = 1$  for all  $g \in G$ . Prove that  $G$  is a minimal Groebner basis if and only if no proper subset of  $G$  is a Groebner basis of  $I$ .
6. Recall the notion of a *minimal* basis for a monomial ideal introduced in Exercise 8 of §4. Show that a Groebner basis  $G$  of  $I$  is minimal if and only if  $\text{LC}(g) = 1$  for all  $g \in G$  and  $\text{LT}(G)$  is a minimal basis of the monomial ideal  $\langle \text{LT}(I) \rangle$ .
7. Fix a monomial order, and let  $G$  and  $\tilde{G}$  be minimal Groebner bases for the ideal  $I$ .
  - a. Prove that  $\text{LT}(G) = \text{LT}(\tilde{G})$ .
  - b. Conclude that  $G$  and  $\tilde{G}$  have the same number of elements.
8. Develop an algorithm that produces a reduced Groebner basis (see Definition 5) for an ideal  $I$ , given as input an arbitrary Groebner basis for  $I$ . Prove that your algorithm works.
9. Consider the ideal

$$I = \langle 3x - 6y - 2z, 2x - 4y + 4w, x - 2y - z - w \rangle \subset k[x, y, z, w]$$

mentioned in the text. We will use lex order with  $x > y > z > w$ .

- a. Show that the linear polynomials determined by the row echelon matrix (3) give a minimal Groebner basis  $I = \langle x - 2y - z - w, z + 3w \rangle$ . Hint: Use Theorem 6 of §6.

- b. Show that the linear polynomials from the reduced row echelon matrix (4) give the reduced Groebner basis  $I = \langle x - 2y + 2w, z + 3w \rangle$ .
10. Let  $A = (a_{ij})$  be an  $n \times m$  matrix with entries in  $k$  and let  $f_i = a_{i1}x_1 + \cdots + a_{im}x_m$  be the linear polynomials in  $k[x_1, \dots, x_m]$  determined by the rows of  $A$ . Then we get the ideal  $I = \langle f_1, \dots, f_n \rangle$ . We will use lex order with  $x_1 > \cdots > x_m$ . Now let  $B = (b_{ij})$  be the reduced row echelon matrix determined by  $A$  and let  $g_1, \dots, g_t$  be the linear polynomials coming from the nonzero rows of  $B$  (so that  $t \leq n$ ). We want to prove that  $g_1, \dots, g_t$  form the reduced Groebner basis of  $I$ .
- Show that  $I = \langle g_1, \dots, g_t \rangle$ . Hint: Show that the result of applying a row operation to  $A$  gives a matrix whose rows generate the same ideal.
  - Use Theorem 6 of §6 to show that  $g_1, \dots, g_t$  form a Groebner basis of  $I$ . Hint: If the leading 1 in the  $i$ th row of  $B$  is in the  $k$ th column, we can write  $g_i = x_k + A$ , where  $A$  is a linear polynomial involving none of the variables corresponding to leading 1's. If  $g_j = x_l + B$  is written similarly, then you need to divide  $S(g_i, g_j) = x_l A - x_k B$  by  $g_1, \dots, g_t$ . Note that you will use only  $g_i$  and  $g_j$  in the division.
  - Explain why  $g_1, \dots, g_t$  is the reduced Groebner basis.
11. Show that the result of applying the Euclidean Algorithm in  $k[x]$  to any pair of polynomials  $f, g$  is a reduced Groebner basis for  $\langle f, g \rangle$  (after dividing by a constant to make the leading coefficient equal to 1). Explain how the steps of the Euclidean Algorithm can be seen as special cases of the operations used in Buchberger's algorithm.
12. Fix  $F = \{f_1, \dots, f_s\}$  and let  $r = \overline{f}^F$ . Since dividing  $f$  by  $F$  gives  $r$  as remainder, adding  $r$  to the polynomials we divide by should reduce the remainder to zero. In other words, we should have  $\overline{f}^{F \cup \{r\}} = 0$  when  $r$  comes last. Prove this as follows.
- When you divide  $f$  by  $F \cup \{r\}$ , consider the first place in the division algorithm where the intermediate dividend  $p$  is not divisible by any  $\text{LT}(f_i)$ . Explain why  $\text{LT}(p) = \text{LT}(r)$  and why the next intermediate dividend is  $p - r$ .
  - From here on in the division algorithm, explain why the leading term of the intermediate dividend is always divisible by one of the  $\text{LT}(f_i)$ . Hint: If this were false, consider the first time it fails. Remember that the terms of  $r$  are not divisible by any  $\text{LT}(f_i)$ .
  - Conclude that the remainder is zero, as desired.
  - (For readers who did Exercise 11 of §3.) Give an alternate proof of  $\overline{f}^{F \cup \{r\}} = 0$  using Exercise 11 of §3.
13. In the discussion following the proof of Theorem 2, we commented that if  $\overline{S(f, g)}^{G'} = 0$ , then remainder stays zero when we enlarge  $G'$ . More generally, if  $\overline{f}^F = 0$  and  $F'$  is obtained from  $F$  by adding elements at the end, then  $\overline{f}^{F'} = 0$ . Prove this.

## §8 First Applications of Groebner Bases

In §1, we posed four problems concerning ideals and varieties. The first was the ideal description problem, which was solved by the Hilbert Basis Theorem in §5. Let us now consider the three remaining problems and see to what extent we can solve them using Groebner bases.

### *The Ideal Membership Problem*

If we combine Groebner bases with the division algorithm, we get the following **ideal membership algorithm**: given an ideal  $I = \langle f_1, \dots, f_s \rangle$ , we can decide whether a



given polynomial  $f$  lies in  $I$  as follows. First, using an algorithm similar to Theorem 2 of §7, find a Groebner basis  $G = \{g_1, \dots, g_t\}$  for  $I$ . Then Corollary 2 of §6 implies that

$$f \in I \text{ if and only if } \overline{f}^G = 0.$$

**Example 1.** Let  $I = \langle f_1, f_2 \rangle = \langle xz - y^2, x^3 - z^2 \rangle \in \mathbb{C}[x, y, z]$ , and use the grlex order. Let  $f = -4x^2y^2z^2 + y^6 + 3z^5$ . We want to know if  $f \in I$ .

The generating set given is not a Groebner basis of  $I$  because  $\text{LT}(I)$  also contains polynomials such as  $\text{LT}(S(f_1, f_2)) = \text{LT}(-x^2y^2 + z^3) = -x^2y^2$  that are not in the ideal  $\langle \text{LT}(f_1), \text{LT}(f_2) \rangle = \langle xz, x^3 \rangle$ . Hence, we begin by computing a Groebner basis for  $I$ . Using a computer algebra system, we find a Groebner basis

$$G = \{f_1, f_2, f_3, f_4, f_5\} = \{xz - y^2, x^3 - z^2, x^2y^2 - z^3, xy^4 - z^4, y^6 - z^5\}.$$

Note that this is a reduced Groebner basis.

We may now test polynomials for membership in  $I$ . For example, dividing  $f$  above by  $G$ , we find

$$f = (-4xy^2z - 4y^4) \cdot f_1 + 0 \cdot f_2 + 0 \cdot f_3 + 0 \cdot f_4 + (-3) \cdot f_5 + 0.$$

Since the remainder is zero, we have  $f \in I$ .

For another example, consider  $f = xy - 5z^2 + x$ . Even without completely computing the remainder on division by  $G$ , we can see from the form of the elements in  $G$  that  $f \notin I$ . The reason is that  $\text{LT}(f) = xy$  is clearly not in the ideal  $\langle \text{LT}(G) \rangle = \langle xz, x^3, x^2y^2, xy^4, y^6 \rangle$ . Hence,  $\overline{f}^G \neq 0$ , so that  $f \notin I$ .

This last observation illustrates the way the properties of an ideal are revealed by the form of the elements of a Groebner basis.

## The Problem of Solving Polynomial Equations

Next, we will investigate how the Groebner basis technique can be applied to solve systems of polynomial equations in several variables. Let us begin by looking at some specific examples.

**Example 2.** Consider the equations

$$(1) \quad \begin{aligned} x^2 + y^2 + z^2 &= 1, \\ x^2 + z^2 &= y, \\ x &= z \end{aligned}$$

in  $\mathbb{C}^3$ . These equations determine  $I = \langle x^2 + y^2 + z^2 - 1, x^2 + z^2 - y, x - z \rangle \subset \mathbb{C}[x, y, z]$ , and we want to find all points in  $\mathbf{V}(I)$ . Proposition 9 of §5 implies that we can compute  $\mathbf{V}(I)$  using *any* basis of  $I$ . So let us see what happens when we use a Groebner basis.

Though we have no compelling reason as of yet to do so, we will compute a Groebner basis on  $I$  with respect to the lex order. The basis is

$$\begin{aligned}g_1 &= x - z, \\g_2 &= -y + 2z^2, \\g_3 &= z^4 + (1/2)z^2 - 1/4.\end{aligned}$$

If we examine these polynomials closely, we find something remarkable. First, the polynomial  $g_3$  depends on  $z$  alone, and its roots can be found by first using the quadratic formula to solve for  $z^2$ , then, taking square roots,

$$z = \pm \frac{1}{2} \sqrt{\pm\sqrt{5} - 1}.$$

This gives us four values of  $z$ . Next, when these values of  $z$  are substituted into the equations  $g_2 = 0$  and  $g_1 = 0$ , those two equations can be solved uniquely for  $y$  and  $x$ , respectively. Thus, there are four solutions altogether of  $g_1 = g_2 = g_3 = 0$ , two real and two complex. Since  $\mathbf{V}(I) = \mathbf{V}(g_1, g_2, g_3)$  by Proposition 9 of §5, we have found *all* solutions of the original equations (1).

**Example 3.** Next, we will consider the system of polynomial equations (2) from Chapter 1, §2, obtained by applying Lagrange multipliers to find the minimum and maximum values of  $x^3 + 2xyz - z^2$  subject to the constraint  $x^2 + y^2 + z^2 = 1$ :

$$\begin{aligned}3x^2 + 2yz - 2x\lambda &= 0, \\2xz - 2y\lambda &= 0, \\2xy - 2z - 2z\lambda &= 0, \\x^2 + y^2 + z^2 - 1 &= 0.\end{aligned}$$

Again, we follow our general hunch and begin by computing a Groebner basis for the ideal in  $\mathbb{R}[x, y, z, \lambda]$  generated by the left-hand sides of the four equations, using the lex order with  $\lambda > x > y > z$ . We find a Groebner basis:

$$\begin{aligned}(2) \quad & \lambda - \frac{3}{2}x - \frac{3}{2}yz - \frac{167616}{3835}z^6 + \frac{36717}{590}z^4 - \frac{134419}{7670}z^2, \\& x^2 + y^2 + z^2 - 1, \\& xy - \frac{19584}{3835}z^5 + \frac{1999}{295}z^3 - \frac{6403}{3835}z, \\& xz + yz^2 - \frac{1152}{3835}z^5 + \frac{108}{295}z^3 + \frac{2556}{3835}z, \\& y^3 + yz^2 - y - \frac{9216}{3835}z^5 + \frac{906}{295}z^3 - \frac{2562}{3835}z, \\& y^2z - \frac{6912}{3835}z^5 + \frac{827}{295}z^3 - \frac{3839}{3835}z, \\& yz^3 - yz - \frac{576}{59}z^6 + \frac{1605}{118}z^4 - \frac{453}{118}z^2, \\& z^7 - \frac{1763}{1152}z^5 + \frac{655}{1152}z^3 - \frac{11}{288}z.\end{aligned}$$

At first glance, this collection of polynomials looks horrendous. (The coefficients of the elements of Groebner basis can be significantly messier than the coefficients of the original generating set.) However, on further observation, we see that once again the last polynomial depends only on the variable  $z$ . We have “eliminated” the other variables in the process of finding the Groebner basis. (Miraculously) the equation obtained by setting this polynomial equal to zero has the roots

$$z = 0, \quad \pm 1, \quad \pm 2/3, \quad \pm \sqrt{11}/8\sqrt{2}.$$

If we set  $z$  equal to each of these values in turn, the remaining equations can then be solved for  $y, x$  (and  $\lambda$ , though its values are essentially irrelevant for our purposes). We obtain the following solutions:

$$\begin{aligned} z = 0; \quad y = 0; \quad x = \pm 1. \\ z = 0; \quad y = \pm 1; \quad x = 0. \\ z = \pm 1; \quad y = 0; \quad x = 0. \\ z = 2/3; \quad y = 1/3; \quad x = -2/3. \\ z = -2/3; \quad y = -1/3; \quad x = -2/3. \\ z = \sqrt{11}/\sqrt{2}; \quad y = -3\sqrt{11}/8\sqrt{2}; \quad x = -3/8. \\ z = -\sqrt{11}/8\sqrt{2}; \quad y = 3\sqrt{11}/8\sqrt{2}; \quad x = -3/8. \end{aligned}$$

From here, it is easy to determine the minimum and maximum values.

Examples 2 and 3 indicate that finding a Groebner basis for an ideal with respect to the lex order simplifies the form of the equations considerably. In particular, we seem to get equations where the variables are eliminated successively. Also, note that the *order* of elimination seems to correspond to the ordering of the variables. For instance, in Example 3, we had variables  $\lambda > x > y > z$ , and if you look back at the Groebner basis (2), you will see that  $\lambda$  is eliminated first,  $x$  second, and so on.

A system of equations in this form is easy to solve, especially when the last equation contains only one variable. We can apply one-variable techniques to try and find its roots, then substitute back into the other equations in the system and solve for the other variables, using a procedure similar to the above examples. The reader should note the analogy between this procedure for solving polynomial systems and the method of “back-substitution” used to solve a linear system in triangular form.

We will study the process of elimination of variables from systems of polynomial equations intensively in Chapter 3. In particular, we will see why lex order gives a Groebner basis that successively eliminates the variables.

### *The Implicitization Problem*

Suppose that the parametric equations

$$\begin{aligned} (3) \quad & x_1 = f_1(t_1, \dots, t_m), \\ & \vdots \\ & x_n = f_n(t_1, \dots, t_m), \end{aligned}$$

define a subset of an algebraic variety  $V$  in  $k^n$ . For instance, this will always be the case if the  $f_i$  are rational functions in  $t_1, \dots, t_m$ , as we will show in Chapter 3. How can we find polynomial equations in the  $x_i$  that define  $V$ ? This problem can be solved using Groebner bases, though a complete proof that this is the case will come only with the results of Chapter 3.

For simplicity, we will restrict our attention for now to cases in which the  $f_i$  are actually *polynomials*. We can study the affine variety in  $k^{m+n}$  defined by equations (3) or

$$\begin{aligned}x_1 - f_1(t_1, \dots, t_m) &= 0, \\ &\vdots \\ x_n - f_n(t_1, \dots, t_m) &= 0.\end{aligned}$$

The basic idea is to eliminate the variables  $t_1, \dots, t_m$  from these equations. This should give us the equations for  $V$ .

Given what we saw in Examples 2 and 3, it makes sense to use a Groebner basis to eliminate variables. We will take the lex order in  $k[t_1, \dots, t_m, x_1, \dots, x_n]$  defined by the variable ordering

$$t_1 > \dots > t_m > x_1 > \dots > x_n.$$

Now suppose we have a Groebner basis of the ideal  $\tilde{I} = \langle x_1 - f_1, \dots, x_n - f_n \rangle$ . Since we are using lex order, we expect the Groebner basis to have polynomials that eliminate variables, and  $t_1, \dots, t_m$  should be eliminated first since they are biggest in our monomial order. Thus, the Groebner basis for  $\tilde{I}$  should contain polynomials that only involve  $x_1, \dots, x_n$ . These are our candidates for the equations of  $V$ .

The ideas just described will be explored in detail when we study elimination theory in Chapter 3. For now, we will content ourselves with some examples to see how this process works.

**Example 4.** Consider the parametric curve  $V$ :

$$\begin{aligned}x &= t^4, \\ y &= t^3, \\ z &= t^2\end{aligned}$$

in  $\mathbb{C}^3$ . We compute a Groebner basis  $G$  of  $I = \langle t^4 - x, t^3 - y, t^2 - z \rangle$  with respect to the lex order in  $\mathbb{C}[t, x, y, z]$ , and we find

$$G = \{-t^2 + z, ty - z^2, tz - y, x - z^2, y^2 - z^3\}.$$

The last two polynomials depend only on  $x, y, z$ , so they define an affine variety of  $\mathbb{C}^3$  containing our curve  $V$ . By the intuition on dimensions that we developed in Chapter 1, we would guess that two equations in  $\mathbb{C}^3$  would define a curve (a 1-dimensional variety). The remaining question to answer is whether  $V$  is the entire intersection of the two surfaces

$$x - z^2 = 0, \quad y^2 - z^3 = 0.$$

Might there be other curves (or even surfaces) in the intersection? We will be able to show that the answer is no when we have established the general results in Chapter 3.

**Example 5.** Now consider the tangent surface of the twisted cubic in  $\mathbb{R}^3$ , which we studied in Chapter 1. This surface is parametrized by

$$\begin{aligned}x &= t + u, \\y &= t^2 + 2tu, \\z &= t^3 + 3t^2u.\end{aligned}$$

We compute a Groebner basis  $G$  for this ideal relative to the lex order defined by  $t > u > x > y > z$ , and we find that  $G$  has 6 elements altogether. If you make the calculation, you will see that only one contains only  $x, y, z$  terms:

$$(4) \quad -(4/3)x^3z + x^2y^2 + 2xyz - (4/3)y^3 - (1/3)z^2 = 0.$$

The variety defined by this equation is a surface containing the tangent surface to the twisted cubic. However, it is possible that the surface given by (4) is strictly bigger than the tangent surface: there may be solutions of (4) that do not correspond to points on the tangent surface. We will return to this example in Chapter 3.

To summarize our findings in this section, we have seen that Groebner bases and the division algorithm give a complete solution of the ideal membership problem. Furthermore, we have seen ways to produce solutions of systems of polynomial equations and to produce equations of parametrically given subsets of affine space. Our success in the examples given earlier depended on the fact that Groebner bases, when computed using lex order, seem to eliminate variables in a very nice fashion. In Chapter 3, we will prove that this is always the case, and we will explore other aspects of what is called elimination theory.

## EXERCISES FOR §8

In all of the following exercises, a computer algebra system should be used to perform the necessary calculations. (Most of the calculations would be very arduous if carried out by hand.)

1. Determine whether  $f = xy^3 - z^2 + y^5 - z^3$  is in the ideal  $I = \langle -x^3 + y, x^2y - z \rangle$ .
2. Repeat Exercise 1 for  $f = x^3z - 2y^2$  and  $I = \langle xz - y, xy + 2z^2, y - z \rangle$ .
3. By the method of Examples 2 and 3, find the points in  $\mathbb{C}^3$  on the variety

$$\mathbf{V}(x^2 + y^2 + z^2 - 1, x^2 + y^2 + z^2 - 2x, 2x - 3y - z).$$

4. Repeat Exercise 3 for  $\mathbf{V}(x^2y - z^3, 2xy - 4z - 1, z - y^2, x^3 - 4zy)$ .
5. Recall from calculus that a *critical point* of a differentiable function  $f(x, y)$  is a point where the partial derivatives  $\frac{\partial f}{\partial x}$  and  $\frac{\partial f}{\partial y}$  vanish simultaneously. When  $f \in \mathbb{R}[x, y]$ , it follows that the critical points can be found by applying our techniques to the system of polynomial equations

$$\frac{\partial f}{\partial x} = \frac{\partial f}{\partial y} = 0.$$

To see how this works, consider the function

$$f(x, y) = (x^2 + y^2 - 4)(x^2 + y^2 - 1) + (x - 3/2)^2 + (y - 3/2)^2.$$

- a. Find all critical points of  $f(x, y)$ .
  - b. Classify your critical points as local maxima, local minima, or saddle points. Hint: Use the second derivative test.
6. Fill in the details of Example 5. In particular, compute the required Groebner basis, and verify that this gives us (up to a constant multiple) the polynomial appearing on the left-hand side of equation (4).
  7. Let the surface  $S$  in  $\mathbb{R}^3$  be formed by taking the *union* of the straight lines joining pairs of points on the lines

$$\left\{ \begin{array}{l} x = t \\ y = 0 \\ z = 1 \end{array} \right\}, \quad \left\{ \begin{array}{l} x = 0 \\ y = 1 \\ z = t \end{array} \right\}$$

with the *same parameter* (i.e.,  $t$ ) *value*. (This is a special example of a class of surfaces called *ruled surfaces*.)

- a. Show that the surface  $S$  can be given in the parametric form:

$$\begin{aligned} x &= ut, \\ y &= 1 - u, \\ z &= u + t - ut. \end{aligned}$$

- b. Using the method of Examples 4 and 5, find an (implicit) equation of a variety  $V$  containing the surface  $S$ .
  - c. Show  $V = S$  (that is, show that every point of the variety  $V$  can be obtained by substituting some values for  $t, u$  in the equations of part a). Hint: Try to “solve” the implicit equation of  $V$  for one variable as a function of the other two.
8. Some parametric curves and surfaces are algebraic varieties even when the given parametrizations involve transcendental functions such as  $\sin$  and  $\cos$ . In this problem, we will see that that the parametric surface  $T$ ,

$$\begin{aligned} x &= (2 + \cos(t)) \cos(u), \\ y &= (2 + \cos(t)) \sin(u), \\ z &= \sin(t), \end{aligned}$$

lies on an affine variety in  $\mathbb{R}^3$ .

- a. Draw a picture of  $T$ . Hint: Use cylindrical coordinates.
- b. Let  $a = \cos(t)$ ,  $b = \sin(t)$ ,  $c = \cos(u)$ ,  $d = \sin(u)$ , and rewrite the above equations as polynomial equations in  $a, b, c, d, x, y, z$ .
- c. The pairs  $a, b$  and  $c, d$  in part b are not *independent* since there are additional polynomial identities

$$a^2 + b^2 - 1 = 0, \quad c^2 + d^2 - 1 = 0$$

stemming from the basic trigonometric identity. Form a system of five equations by adjoining the above equations to those from part b and compute a Groebner basis for the corresponding ideal. Use the lex monomial ordering and the variable order

$$a > b > c > d > x > y > z.$$

There should be exactly one polynomial in your basis that depends only on  $x, y, z$ . This is the equation of a variety containing  $T$ .

9. Consider the parametric curve  $K \subset \mathbb{R}^3$  given by

$$x = (2 + \cos(2s)) \cos(3s),$$

$$y = (2 + \cos(2s)) \sin(3s),$$

$$z = \sin(2s).$$

- Express the equations of  $K$  as polynomial equations in  $x, y, z, a = \cos(s), b = \sin(s)$ . Hint: Trig identities.
  - By computing a Groebner basis for the ideal generated by the equations from part a and  $a^2 + b^2 - 1$  as in Exercise 8, show that  $K$  is (a subset of) an affine algebraic curve. Find implicit equations for a curve containing  $K$ .
  - Show that the equation of the surface from Exercise 8 is *contained in* the ideal generated by the equations from part b. What does this result mean geometrically? (You can actually reach the same conclusion by comparing the parametrizations of  $T$  and  $K$ , without calculations.)
10. Use the method of Lagrange Multipliers to find the point(s) on the surface  $x^4 + y^2 + z^2 - 1 = 0$  closest to the point  $(1, 1, 1)$  in  $\mathbb{R}^3$ . Hint: Proceed as in Example 3. (You may need to “fall back” on a *numerical* method to solve the equations you get.)
11. Suppose we have numbers  $a, b, c$  which satisfy the equations

$$a + b + c = 3,$$

$$a^2 + b^2 + c^2 = 5,$$

$$a^3 + b^3 + c^3 = 7.$$

- Prove that  $a^4 + b^4 + c^4 = 9$ . Hint: Regard  $a, b, c$  as variables and show carefully that  $a^4 + b^4 + c^4 - 9 \in \langle a + b + c - 3, a^2 + b^2 + c^2 - 5, a^3 + b^3 + c^3 - 7 \rangle$ .
- Show that  $a^5 + b^5 + c^5 \neq 11$ .
- What are  $a^5 + b^5 + c^5$  and  $a^6 + b^6 + c^6$ ? Hint: Compute remainders.

## §9 (Optional) Improvements on Buchberger’s Algorithm

In designing useful mathematical software, attention must be paid not only to the *correctness* of the algorithms employed, but also to their *efficiency*. In this section, we will discuss some improvements on the basic Buchberger algorithm for computing Groebner bases that can greatly speed up the calculations. Some version of these improvements has been built into most of the computer algebra systems that offer Groebner basis packages. The section will conclude with a brief discussion of the complexity of Buchberger’s algorithm. This is still an active area of research though, and there are as yet no definitive results in this direction.

The first class of modifications we will consider concern Theorem 6 of §6, which states that an ideal basis  $G$  is a Groebner basis provided that  $\overline{S(f, g)}^G = 0$  for all  $f, g \in G$ . If you look back at §7, you will see that this criterion is the driving force behind Buchberger’s algorithm. Hence, a good way to improve the efficiency of the algorithm would be to show that fewer S-polynomials  $S(f, g)$  need to be considered. As you learned from doing examples by hand, the polynomial divisions involved are the

most computationally intensive part of Buchberger's algorithm. Thus, any reduction of the number of divisions that need to be performed is all to the good.

To identify S-polynomials that can be ignored in Theorem 6 of §6, we first need to give a more general view of what it means to have zero remainder. The definition is as follows.

**Definition 1.** Fix a monomial order and let  $G = \{g_1, \dots, g_t\} \subset k[x_1, \dots, x_n]$ . Given  $f \in k[x_1, \dots, x_n]$ , we say that  $f$  **reduces to zero modulo  $G$** , written

$$f \rightarrow_G 0,$$

if  $f$  can be written in the form

$$f = a_1 g_1 + \dots + a_t g_t, \quad a_i \in k[x_1, \dots, x_n],$$

such that whenever  $a_i g_i \neq 0$ , we have

$$\text{multideg}(f) \geq \text{multideg}(a_i g_i).$$

To understand the relation between Definition 1 and the division algorithm, we have the following lemma.

**Lemma 2.** Let  $G = \{g_1, \dots, g_t\}$  be an ordered set of elements of  $k[x_1, \dots, x_n]$  and fix  $f \in k[x_1, \dots, x_n]$ . Then  $\overline{f}^G = 0$  implies  $f \rightarrow_G 0$ , though the converse is false in general.

**Proof.** If  $\overline{f}^G = 0$ , then the division algorithm implies

$$f = a_1 g_1 + \dots + a_t g_t + 0,$$

and by Theorem 3 of §3, whenever  $a_i g_i \neq 0$ , we have

$$\text{multideg}(f) \geq \text{multideg}(a_i g_i).$$

This shows that  $f \rightarrow_G 0$ . To see that the converse may fail, consider Example 5 from §3. If we divide  $f = xy^2 - x$  by  $G = (xy + 1, y^2 - 1)$ , the division algorithm gives

$$xy^2 - x = y \cdot (xy + 1) + 0 \cdot (y^2 - 1) + (-x - y),$$

so that  $\overline{f}^G = -x - y \neq 0$ . Yet we can also write

$$xy^2 - x = 0 \cdot (xy + 1) + x \cdot (y^2 - 1),$$

and since

$$\text{multideg}(xy^2 - x) \geq \text{multideg}(x \cdot (y^2 - 1))$$

(in fact, they are equal), it follows that  $f \rightarrow_G 0$ . □

As an example of how Definition 1 can be used, let us state a more general version of the Groebner basis criterion from §6.



**Theorem 3.** A basis  $G = \{g_1, \dots, g_t\}$  for an ideal  $I$  is a Groebner basis if and only if  $S(g_i, g_j) \rightarrow_G 0$  for all  $i \neq j$ .

**Proof.** In Theorem 6 of §6, we proved this result under the hypothesis that  $\overline{S(g_i, g_j)}^G = 0$  for all  $i \neq j$ . But if you examine the proof, you will see that all we used was

$$S(g_j, g_k) = \sum_{i=1}^t a_{ijk} g_i,$$

where

$$\text{multideg}(a_{ijk} g_i) \leq \text{multideg}(S(g_j, g_k))$$

[see (6) and (7) from §6]. This is exactly what  $S(g_i, g_j) \rightarrow_G 0$  means, and the theorem follows.  $\square$

By Lemma 2, notice that Theorem 6 of §6 is a special case of Theorem 3. To exploit the freedom given by Theorem 3, we next show that certain S-polynomials are guaranteed to reduce to zero.

**Proposition 4.** Given a finite set  $G \subset k[x_1, \dots, x_n]$ , suppose that we have  $f, g \in G$  such that

$$\text{LCM}(\text{LM}(f), \text{LM}(g)) = \text{LM}(f) \cdot \text{LM}(g).$$

This means that the leading monomials of  $f$  and  $g$  are relatively prime. Then  $S(f, g) \rightarrow_G 0$ .

**Proof.** For simplicity, we assume that  $f, g$  have been multiplied by appropriate constants to make  $\text{LC}(f) = \text{LC}(g) = 1$ . Write  $f = \text{LM}(f) + p, g = \text{LM}(g) + q$ . Then, since  $\text{LCM}(\text{LM}(f), \text{LM}(g)) = \text{LM}(f) \cdot \text{LM}(g)$ , we have

$$\begin{aligned} S(f, g) &= \text{LM}(g) \cdot f - \text{LM}(f) \cdot g \\ &= (g - q) \cdot f - (f - p) \cdot g \\ &= g \cdot f - q \cdot f - f \cdot g + p \cdot g \\ &= p \cdot g - q \cdot f. \end{aligned} \tag{1}$$

We claim that

$$\text{multideg}(S(f, g)) = \max(\text{multideg}(p \cdot g), \text{multideg}(q \cdot f)). \tag{2}$$

Note that (1) and (2) imply  $S(f, g) \rightarrow_G 0$  since  $f, g \in G$ . To prove (2), observe that in the last polynomial of (1), the leading monomials of  $p \cdot g$  and  $q \cdot f$  are distinct and, hence, cannot cancel. For if the leading monomials were the same, we would have

$$\text{LM}(p) \cdot \text{LM}(g) = \text{LM}(q) \cdot \text{LM}(f).$$

However this is impossible if  $\text{LM}(f), \text{LM}(g)$  are relatively prime: from the last equation,  $\text{LM}(g)$  would have to divide  $\text{LM}(q)$ , which is absurd since  $\text{LM}(g) > \text{LM}(q)$ .  $\square$

For an example of how this proposition works, let  $G = (yz + y, x^3 + y, z^4)$  and use grlex order on  $k[x, y, z]$ . Then

$$S(x^3 + y, z^4) \rightarrow_G 0$$

by Proposition 4. However, using the division algorithm, it is easy to check that

$$S(x^3 + y, z^4) = yz^4 = (z^3 - z^2 + z - 1)(yz + y) + y.$$

so that

$$\overline{S(x^3 + y, z^4)}^G = y \neq 0.$$

This explains why we need Definition 1: Proposition 4 is false if we use the notion of zero remainder coming from the division algorithm.

Note that Proposition 4 gives a more efficient version of Theorem 3: to test for a Groebner basis, we need only have  $S(g_i, g_j) \rightarrow_G 0$  for those  $i < j$  where  $\text{LM}(g_i)$  and  $\text{LM}(g_j)$  are not relatively prime. But before we apply this to improving Buchberger’s algorithm, let us explore a second way to improve Theorem 3.

The basic idea is to better understand the role played by S-polynomials in the proof of Theorem 6 of §6. Since S-polynomials were constructed to cancel leading terms, this means we should study cancellation in greater generality. Hence, we will introduce the notion of a *syzygy* on the leading terms of a set  $F = \{f_1, \dots, f_s\}$ . This word is used in astronomy to indicate an *alignment* of three planets or other heavenly bodies. The root is a Greek word meaning “yoke.” In an astronomical syzygy, planets are “yoked together”; in a mathematical syzygy, it is polynomials that are “yoked.”

**Definition 5.** Let  $F = (f_1, \dots, f_s)$ . A **syzygy** on the leading terms  $\text{LT}(f_1), \dots, \text{LT}(f_s)$  of  $F$  is an  $s$ -tuple of polynomials  $S = (h_1, \dots, h_s) \in (k[x_1, \dots, x_n])^s$  such that

$$\sum_{i=1}^s h_i \cdot \text{LT}(f_i) = 0.$$

We let  $S(F)$  be the subset of  $(k[x_1, \dots, x_n])^s$  consisting of all syzygies on the leading terms of  $F$ .

For an example of a syzygy, consider  $F = (x, x^2 + z, y + z)$ . Then using the lex order,  $S = (-x + y, 1, -x) \in (k[x, y, z])^3$  defines a syzygy in  $S(F)$  since

$$(-x + y) \cdot \text{LT}(x) + 1 \cdot \text{LT}(x^2 + z) + (-x) \cdot \text{LT}(y + z) = 0.$$

Let  $\mathbf{e}_i = (0, \dots, 0, 1, 0, \dots, 0) \in (k[x_1, \dots, x_n])^s$ , where the 1 is in the  $i$ th place. Then a syzygy  $S \in S(F)$  can be written as  $S = \sum_{i=1}^s h_i \mathbf{e}_i$ . For an example of how to use this notation, consider the syzygies that come from S-polynomials. Namely, given a pair  $\{f_i, f_j\} \subset F$  where  $i < j$ , let  $x^\gamma$  be the least common multiple of the leading monomials of  $f_i$  and  $f_j$ . Then

$$(3) \quad S_{ij} = \frac{x^\gamma}{\text{LT}(f_i)} \mathbf{e}_i - \frac{x^\gamma}{\text{LT}(f_j)} \mathbf{e}_j$$

gives a syzygy on the leading terms of  $F$ . In fact, the name S-polynomial is actually an abbreviation for “syzygy polynomial.”

It is straightforward to check that the set of syzygies is closed under coordinate-wise sums, and under coordinate-wise multiplication by polynomials (see Exercise 1). An especially nice fact about  $S(F)$  is that it has a finite *basis*—there is a finite collection of syzygies such that every other syzygy is a linear combination with polynomial coefficients of the basis syzygies.

However, before we can prove this, we need to learn a bit more about the structure of  $S(F)$ . We first define the notion of a *homogeneous* syzygy.

**Definition 6.** An element  $S \in S(F)$  is **homogeneous of multidegree  $\alpha$** , where  $\alpha \in \mathbb{Z}_{\geq 0}^n$ , provided that

$$S = (c_1x^{\alpha(1)}, \dots, c_sx^{\alpha(s)}),$$

where  $c_i \in k$  and  $\alpha(i) + \text{multideg}(f_i) = \alpha$  whenever  $c_i \neq 0$ .

You should check that the syzygy  $S_{ij}$  given in (3) is homogeneous of multidegree  $\gamma$  (see Exercise 4). We can decompose syzygies into homogeneous ones as follows.

**Lemma 7.** Every element of  $S(F)$  can be written uniquely as a sum of homogeneous elements of  $S(F)$ .

**Proof.** Let  $S = (h_1, \dots, h_s) \in S(F)$ . Fix an exponent  $\alpha \in \mathbb{Z}_{>0}^n$ , and let  $h_{i\alpha}$  be the term of  $h_i$ , (if any) such that  $h_{i\alpha}f_i$  has multidegree  $\alpha$ . Then we must have  $\sum_{i=1}^s h_{i\alpha}\text{LT}(f_i) = 0$  since the  $h_{i\alpha}\text{LT}(f_i)$  are the terms of multidegree  $\alpha$  in the sum  $\sum_{i=1}^s h_i\text{LT}(f_i) = 0$ . Then  $S_\alpha = (h_{1\alpha}, \dots, h_{s\alpha})$  is a homogeneous element of  $S(F)$  of degree  $\alpha$  and  $S = \sum_\alpha S_\alpha$ .

The proof of uniqueness will be left to the reader (see Exercise 5). □

We can now prove that the  $S_{ij}$ ’s form a basis of all syzygies on the leading terms.

**Proposition 8.** Given  $F = (f_1, \dots, f_s)$ , every syzygy  $S \in S(F)$  can be written as

$$S = \sum_{i < j} u_{ij} S_{ij},$$

where  $u_{ij} \in k[x_1, \dots, x_n]$  and the syzygy  $S_{ij}$  is defined as in (3).

**Proof.** By Lemma 7, we can assume that  $S$  is homogeneous of multidegree  $\alpha$ . Then  $S$  must have at least two nonzero components, say  $c_i x^{\alpha(i)}$  and  $c_j x^{\alpha(j)}$ , where  $i < j$ . Then  $\alpha(i) + \text{multideg}(f_i) = \alpha(j) + \text{multideg}(f_j) = \alpha$ , which implies that  $x^\gamma = \text{LCM}(\text{LM}(f_i), \text{LM}(f_j))$  divides  $x^\alpha$ . Since

$$S_{ij} = \frac{x^\gamma}{\text{LT}(f_i)} \mathbf{e}_i - \frac{x^\gamma}{\text{LT}(f_j)} \mathbf{e}_j,$$

an easy calculation shows that the  $i$ th component of

$$S - c_i \text{LC}(f_i) x^{\alpha-\gamma} S_{ij}$$

must be zero, and the only other component affected is the  $j$ th. It follows that from  $S$ , we have produced a homogeneous syzygy with fewer nonzero components. Since a nonzero syzygy must have at least two nonzero components, continuing in this way will eventually enable us to write  $S$  as a combination of the  $S_{ij}$ 's, and we are done.  $\square$

This proposition explains our observation in §6 that S-polynomials account for all possible cancellation of leading terms.

An interesting observation is that we do not always need *all* of the  $S_{ij}$ 's to generate the syzygies in  $S(F)$ . For example, let  $F = (x^2y^2 + z, xy^2 - y, x^2y + yz)$  and use lex order in  $k[x, y, z]$ . The three syzygies corresponding to the S-polynomials are

$$\begin{aligned} S_{12} &= (1, -x, 0), \\ S_{13} &= (1, 0, -y), \\ S_{23} &= (0, x, -y), \end{aligned}$$

However, we see that  $S_{23} = S_{13} - S_{12}$ . Then,  $S_{23}$  is *redundant* in the sense that it can be obtained from  $S_{12}, S_{13}$  by a linear combination. (In this case, the coefficients are constants; in more general examples, we might find relations between syzygies with polynomial coefficients.) In this case,  $\{S_{12}, S_{13}\}$  forms a basis for the syzygies. Later in the section, we will give a systematic method for making smaller bases of  $S(F)$ .

We are now ready to state a more refined version of our algorithmic criterion for Groebner bases.

**Theorem 9.** *A basis  $G = (g_1, \dots, g_t)$  for an ideal  $I$  is a Groebner basis if and only if for every element  $S = (h_1, \dots, h_t)$  in a homogeneous basis for the syzygies  $S(G)$ , we have*

$$S \cdot G = \sum_{i=1}^t h_i g_i \rightarrow_G 0.$$

**Proof.** We will use the strategy (and notation) of the proof of Theorem 6 of §6. We start with  $f = \sum_{i=1}^t h_i g_i$ , where  $m(i) = \text{multideg}(h_i g_i)$  and  $\delta = \max(m(i))$  is minimal among all ways of writing  $f$  in terms of  $g_1, \dots, g_t$ . As before, we need to show that  $\text{multideg}(f) < \delta$  leads to a contradiction.

From (4) in §6, we know that  $\text{multideg}(f) < \delta$  implies that  $\sum_{m(i)=\delta} \text{LT}(h_i)g_i$  has strictly smaller multidegree. This therefore means that  $\sum_{m(i)=\delta} \text{LT}(h_i)\text{LT}(g_i) = 0$ , so that

$$S = \sum_{m(i)=\delta} \text{LT}(h_i)\mathbf{e}_i$$

is a syzygy in  $S(G)$ . Note also that  $S$  is homogeneous of multidegree  $\delta$ . Our hypothesis then gives us a homogeneous basis  $S_1, \dots, S_m$  of  $S(G)$  with the nice property that  $S_j \cdot G \rightarrow_G 0$  for all  $j$ . We can write  $S$  in the form

$$(4) \quad S = u_1 S_1 + \dots + u_m S_m.$$

By writing the  $u_j$ 's as sums of terms and expanding, we see that (4) expresses  $S$  as a sum of homogeneous syzygies. Since  $S$  is homogeneous of multidegree  $\delta$ , it follows from the uniqueness of Lemma 7 that we can discard all syzygies not of multidegree  $\delta$ . Thus, in (4), we can assume that, for each  $j$ , either

$$u_j = 0 \quad \text{or} \quad u_j S_j \text{ is homogeneous of multidegree } \delta.$$

Suppose that  $S_j$  has multidegree  $\gamma_j$ . If  $u_j \neq 0$ , then it follows that  $u_j$  can be written in the form  $u_j = c_j x^{\delta-\gamma_j}$  for some  $c_j \in k$ . Thus, (4) can be written

$$S = \sum_j c_j x^{\delta-\gamma_j} S_j,$$

where the sum is over those  $j$ 's with  $u_j \neq 0$ . If we take the dot product of each side with  $G$ , we obtain

$$(5) \quad \sum_{m(i)=\delta} \text{LT}(h_i) g_i = S \cdot G = \sum_j c_j x^{\delta-\gamma_j} S_j \cdot G.$$

By hypothesis,  $S_j \cdot G \rightarrow_G 0$ , which means that

$$(6) \quad S_j \cdot G = \sum_{i=1}^t a_{ij} g_i,$$

where

$$(7) \quad \text{multideg}(a_{ij} g_i) \leq \text{multideg}(S_j \cdot G)$$

for all  $i, j$ . Note that (5), (6), and (7) are similar to the corresponding (5), (6), and (7) from §6. In fact, the remainder of the proof of the theorem is identical to what we did in §6. The only detail you will need to check is that  $x^{\delta-\gamma_j} S_j \cdot G$  has multidegree  $< \delta$  (see Exercise 6). The theorem is now proved.  $\square$

Note that Theorem 6 of §6 is a special case of this result. Namely, if we use the basis  $\{S_{ij}\}$  for the syzygies  $S(G)$ , then the polynomials  $S_{ij} \cdot G$  to be tested are precisely the  $S$ -polynomials  $S(g_i, g_j)$ .

To exploit the power of Theorem 9, we need to learn how to make smaller bases of  $S(G)$ . We will show next that starting with the basis  $\{S_{ij} : i < j\}$ , there is a systematic way to predict when elements can be omitted.

**Proposition 10.** *Given  $G = (g_1, \dots, g_t)$ , suppose that  $\mathcal{S} \subset \{S_{ij} : 1 \leq i < j \leq t\}$  is a basis of  $S(G)$ . In addition, suppose we have distinct elements  $g_i, g_j, g_k \in G$  such that*

$$\text{LT}(g_k) \text{ divides } \text{LCM}(\text{LT}(g_i), \text{LT}(g_j)).$$

*If  $S_{ik}, S_{jk} \in \mathcal{S}$ , then  $\mathcal{S} - \{S_{ij}\}$  is also a basis of  $S(G)$ . (Note: If  $i > j$ , we set  $S_{ij} = S_{ji}$ .)*

**Proof.** For simplicity, we will assume that  $i < j < k$ . Set  $x^{\gamma_{ij}} = \text{LCM}(\text{LM}(g_i), \text{LM}(g_j))$  and let  $x^{\gamma_{ik}}$  and  $x^{\gamma_{jk}}$  be defined similarly. Then our hypothesis implies that  $x^{\gamma_{ik}}$  and  $x^{\gamma_{jk}}$

both divide  $x^{\gamma_{ij}}$ . In Exercise 7, you will verify that

$$S_{ij} = \frac{x^{\gamma_{ij}}}{x^{\gamma_{ik}}} S_{ik} - \frac{x^{\gamma_{ij}}}{x^{\gamma_{jk}}} S_{jk},$$

and the proposition is proved. □

To incorporate this proposition into an algorithm for creating Groebner bases, we will use the ordered pairs  $(i, j)$  with  $i < j$  to keep track of which syzygies we want. Since we sometimes will have an  $i \neq j$  where we do not know which is larger, we will use the following notation: given  $i \neq j$ , define

$$[i, j] = \begin{cases} (i, j) & \text{if } i < j \\ (j, i) & \text{if } i > j. \end{cases}$$

We can now state an improved version of Buchberger's algorithm that takes into account the results proved so far.

**Theorem 11.** *Let  $I = \langle f_1, \dots, f_s \rangle$  be a polynomial ideal. Then a Groebner basis for  $I$  can be constructed in a finite number of steps by the following algorithm:*

Input :  $F = (f_1, \dots, f_s)$

Output :  $G$ , a Groebner basis for  $I = \langle f_1, \dots, f_s \rangle$

{initialization}

$B := \{(i, j) : 1 \leq i < j \leq s\}$

$G := F$

$t := s$

{iteration}

WHILE  $B \neq \emptyset$  DO

Select  $(i, j) \in B$

IF  $\text{LCM}(\text{LT}(f_i), \text{LT}(f_j)) \neq \text{LT}(f_i)\text{LT}(f_j)$  AND

Criterion  $(f_i, f_j, B)$  is false THEN

$S := \overline{S(f_i, f_j)}^G$

IF  $S \neq 0$  THEN

$t := t + 1; f_t := S$

$G := G \cup \{f_t\}$

$B := B \cup \{(i, t) : 1 \leq i \leq t - 1\}$

$B := B - \{(i, j)\},$

where Criterion $(f_i, f_j, B)$  is true provided that there is some  $k \notin \{i, j\}$  for which the pairs  $[i, k]$  and  $[j, k]$  are **not** in  $B$  and  $\text{LT}(f_k)$  divides  $\text{LCM}(\text{LT}(f_i), \text{LT}(f_j))$ . (Note that this criterion is based on Proposition 10.)

**Proof.** The basic idea of the algorithm is that  $B$  records the pairs  $(i, j)$  that remain to be considered. Furthermore, we only compute the remainder of those S-polynomials  $S(g_i, g_j)$  for which neither Proposition 4 nor Proposition 10 apply.

To prove that the algorithm works, we first observe that at every stage of the algorithm,  $B$  has the property that if  $1 \leq i < j \leq t$  and  $(i, j) \notin B$ , then

$$(8) \quad S(f_i, f_j) \rightarrow_G 0 \quad \text{or} \quad \text{Criterion}(f_i, f_j, B) \text{ holds.}$$

Initially, this is true since  $B$  starts off as the set of all possible pairs. We must show that if (8) holds for some intermediate value of  $B$ , then it continues to hold when  $B$  changes, say to  $B'$ .

To prove this, assume that  $(i, j) \notin B'$ . If  $(i, j) \in B$ , then an examination of the algorithm shows that  $B' = B - \{(i, j)\}$ . Now look at the step before we remove  $(i, j)$  from  $B$ . If  $\text{LCM}(\text{LT}(f_i), \text{LT}(f_j)) = \text{LT}(f_i)\text{LT}(f_j)$ , then  $S(f_i, f_j) \rightarrow_G 0$  by Proposition 4, and (8) holds. Also if  $\text{Criterion}(f_i, f_j, B)$  is true, then (8) clearly holds. Now suppose that both of these fail. In this case, the algorithm computes the remainder  $S = \overline{S(f_i, f_j)}^G$ . If  $S = 0$ , then  $S(f_i, f_j) \rightarrow_G 0$  by Lemma 2, as desired. Finally, if  $S \neq 0$ , then we enlarge  $G$  to be  $G' = G \cup \{S\}$ , and we leave it as an exercise to show that  $S(f_i, f_j) \rightarrow_{G'} 0$ .

It remains to study the case when  $(i, j) \notin B$ . Here, (8) holds for  $B$ , and in Exercise 9, you will show that this implies that (8) also holds for  $B'$ .

Next, we need to show that  $G$  is a Groebner basis when  $B = \emptyset$ . To prove this, let  $t$  be the length of  $G$ , and consider the set  $\mathcal{I}$  consisting of all pairs  $(i, j)$  for  $1 \leq i < j \leq t$  where  $\text{Criterion}(f_i, f_j, B)$  was *false* when  $(i, j)$  was selected in the algorithm. We claim that  $\mathcal{S} = \{S_{ij} : (i, j) \in \mathcal{I}\}$  is a basis of  $S(G)$  with the property that  $S_{ij} \cdot G = S(f_i, f_j) \rightarrow_G 0$  for all  $S_{ij} \in \mathcal{S}$ . This claim and Theorem 9 will prove that  $G$  is a Groebner basis.

To prove our claim, note that  $B = \emptyset$  implies that (8) holds for *all* pairs  $(i, j)$  for  $1 \leq i < j \leq t$ . It follows that  $S(f_i, f_j) \rightarrow_G 0$  for all  $(i, j) \in \mathcal{I}$ . It remains to show that  $\mathcal{S}$  is a basis of  $S(G)$ . To prove this, first notice that we can *order* the pairs  $(i, j)$  according to when they were removed from  $B$  in the algorithm (see Exercise 10 for the details of this ordering). Now go through the pairs in reverse order, starting with the last removed, and delete the pairs  $(i, j)$  for which  $\text{Criterion}(f_i, f_j, B)$  was true at that point in the algorithm. After going through all pairs, those that remain are precisely the elements of  $\mathcal{I}$ . Let us show that at every stage of this process, the syzygies corresponding to the pairs  $(i, j)$  not yet deleted form a basis of  $S(G)$ . This is true initially because we started with all of the  $S_{ij}$ 's, which we know to be a basis. Further, if at some point we delete  $(i, j)$ , then the definition of  $\text{Criterion}(f_i, f_j, B)$  implies that there is some  $k$  where  $\text{LT}(f_k)$  satisfies the LCM condition and  $[i, k], [j, k] \notin B$ . Thus,  $[i, k]$  and  $[j, k]$  were removed earlier from  $B$ , and hence  $S_{ik}$  and  $S_{jk}$  are still in the set we are creating because we are going in reverse order. It follows from Proposition 10 that we still have a basis even after deleting  $S_{ij}$ .

Finally, we need to show that the algorithm terminates. As in the proof of the original algorithm (Theorem 2 of §7),  $G$  is always a basis of our ideal, and each time we enlarge  $G$ , the monomial ideal  $\langle \text{LT}(G) \rangle$  gets strictly larger. By the ACC, it follows that at some point,  $G$  must stop growing, and thus, we eventually stop adding elements to  $B$ . Since every pass through the WHILE...DO loop removes an element of  $B$ , we must eventually get  $B = \emptyset$ , and the algorithm comes to an end.  $\square$

The algorithm given above is still not optimal, and several strategies have been found to improve its efficiency further. For example, our discussion of the division algorithm in  $k[x_1, \dots, x_n]$  (Theorem 3 of §3), we allowed the divisors  $f_1, \dots, f_s$  to be listed in any order. In practice, some effort could be saved on average if we arranged the  $f_i$  so that their leading terms are listed in increasing order with respect to the chosen monomial ordering. Since the smaller  $\text{LT}(f_i)$  are more likely to be used during the division algorithm, listing them earlier means that fewer comparisons will be required. A second strategy concerns the step where we choose  $(i, j) \in B$  in the algorithm of Theorem 11. BUCHBERGER (1985) suggests that there will often be some savings if we pick  $(i, j) \in B$  such that  $\text{LCM}(\text{LM}(f_i), \text{LM}(f_j))$  is as *small* as possible. The corresponding S-polynomials will tend to yield any nonzero remainders (and new elements of the Groebner basis) sooner in the process, so there will be more of a chance that subsequent remainders  $S(f_i, f_j)_G$  will be zero. This *normal selection strategy* is discussed in more detail in BECKER and WEISPFENNING (1993), BUCHBERGER (1985) and GEBAUER and MÖLLER (1988). Finally, there is the idea of *sugar*, which is a refinement of the normal selection strategy. Sugar and its variant *double sugar* can be found in GIOVINI, MORA, NIESI, ROBBIANO and TRAVERSO (1991).

In another direction, one can also modify the algorithm so that it will automatically produce a reduced Groebner basis (as defined in §7). The basic idea is to systematically reduce  $G$  each time it is enlarged. Incorporating this idea also generally lessens the number of S-polynomials that must be divided in the course of the algorithm. For a further discussion of this idea, consult BUCHBERGER (1985).

We will end this section with a short discussion of the complexity of Buchberger's algorithm. Even with the best currently known versions of the algorithm, it is still easy to generate examples of ideals for which the computation of a Groebner basis takes a tremendously long time and/or consumes a huge amount of storage space. There are several reasons for this:

- The total degrees of intermediate polynomials that must be generated as the algorithm proceeds can be quite large.
- The coefficients of the elements of a Groebner basis can be quite complicated rational numbers, even when the coefficients of the original ideal generators were small integers. See Example 3 of §8 or Exercise 13 of this section for some instances of this phenomenon.

For these reasons, a large amount of theoretical work has been done to try to establish uniform upper bounds on the degrees of the intermediate polynomials in Groebner basis calculations when the degrees of the original generators are given. For some specific results in this area, see DUBÉ (1990) and MÖLLER and MORA (1984). The idea is to measure to what extent the Groebner basis method will continue to be tractable as larger and larger problems are attacked.

The bounds on the degrees of the generators in a Groebner basis are quite large, and it has been shown that large bounds are necessary. For instance, MAYR and MEYER (1982) give examples where the construction of a Groebner basis for an ideal generated by polynomials of degree less than or equal to some  $d$  can involve polynomials of degree proportional to  $2^{2^d}$ . As  $d \rightarrow \infty$ ,  $2^{2^d}$  grows *very* rapidly. Even when grevlex order is



used (which often gives the smallest Groebner bases—see below), the degrees can be quite large. For example, consider the polynomials

$$x^{n+1} - yz^{n-1}w, \quad xy^{n-1} - z^n, \quad x^n z - y^n w.$$

If we use grevlex order with  $x > y > z > w$ , then Mora [see LAZARD (1983)] showed that the reduced Groebner basis contains the polynomial

$$z^{n^2+1} - y^{n^2} w.$$

The results led for a time to some pessimism concerning the ultimate practicality of the Groebner basis method as a whole. Further work has shown, however, that for ideals in two and three variables, much more reasonable upper degree bounds are available [see, for example, LAZARD (1983) and WINKLER (1984)]. Furthermore, in any case the running time and storage space required by the algorithm seem to be much more manageable “on average” (and this tends to include most cases of geometric interest) than in the worst cases. There is also a growing realization that computing “algebraic” information (such as the primary decomposition of an ideal—see Chapter 4) should have greater complexity than computing “geometric” information (such as the dimension of a variety—see Chapter 9). A good reference for this is GIUSTI and HEINTZ (1993), and a discussion of a wide variety of complexity issues related to Groebner bases can be found in BAYER and MUMFORD (1993).

Finally, experimentation with changes of variables and varying the ordering of the variables often can reduce the difficulty of the computation drastically. BAYER and STILLMAN (1987a) have shown that in most cases, the grevlex order should produce a Groebner basis with polynomials of the smallest total degree. In a different direction, some versions of the algorithm will change the term ordering as the algorithm progresses in order to produce a more efficient Groebner basis. This is discussed by GRITZMANN and STURMFELS (1993).

For more recent developments concerning Buchberger’s algorithm, we refer readers to the special issue of the *Journal of Symbolic Computation* devoted to efficient computation of Groebner bases, scheduled to appear in 2007.

## EXERCISES FOR §9

- Let  $S = (c_1, \dots, c_s)$  and  $T = (d_1, \dots, d_s) \in (k[x_1, \dots, x_n])^s$  be syzygies on the leading terms of  $F = (f_1, \dots, f_s)$ .
  - Show that  $S + T = (c_1 + d_1, \dots, c_s + d_s)$  is also a syzygy.
  - Show that if  $g \in k[x_1, \dots, x_n]$ , then  $g \cdot S = (gc_1, \dots, gc_s)$  is also a syzygy.
- Given any  $G = (g_1, \dots, g_s) \in (k[x_1, \dots, x_n])^s$ , we can define a syzygy on  $G$  to be an  $s$ -tuple  $S = (h_1, \dots, h_s) \in (k[x_1, \dots, x_n])^s$  such that  $\sum_i h_i g_i = 0$ . [Note that the syzygies we studied in the text are syzygies on  $\text{LT}(G) = (\text{LT}(g_1), \dots, \text{LT}(g_s))$ .]
  - Show that if  $G = (x^2 - y, xy - z, y^2 - xz)$ , then  $(z, -y, x)$  defines a syzygy on  $G$ .
  - Find another syzygy on  $G$  from part (a).
  - Show that if  $S, T$  are syzygies on  $G$ , and  $g \in k[x_1, \dots, x_n]$ , then  $S + T$  and  $gS$  are also syzygies on  $G$ .

3. Let  $M$  be an  $m \times (m + 1)$  matrix of polynomials in  $k[x_1, \dots, x_n]$ . Let  $I$  be the ideal generated by the determinants of all the  $m \times m$  submatrices of  $M$  (such ideals are examples of *determinantal* ideals).
  - a. Find a  $2 \times 3$  matrix  $M$  such that the associated determinantal ideal of  $2 \times 2$  submatrices is the ideal with generators  $G$  as in Exercise 2.
  - b. Explain the syzygy given in part a of Exercise 2 in terms of your matrix.
  - c. Give a general way to produce syzygies on the generators of a determinantal ideal. Hint: Find ways to produce  $(m + 1) \times (m + 1)$  matrices containing  $M$ , whose determinants are automatically zero.
4. Prove that the syzygy  $S_{ij}$  defined in (3) is homogeneous of multidegree  $\gamma$ .
5. Complete the proof of Lemma 7 by showing that the decomposition into homogeneous components is unique. Hint: First show that if  $S = \sum_{\alpha} S'_{\alpha}$ , where  $S'_{\alpha}$  has multidegree  $\alpha$ , then, for a fixed  $i$ , the  $i$ th components of the  $S'_{\alpha}$  are either 0 or have multidegree  $\alpha - \text{multideg}(f_i)$  and, hence, give distinct terms as  $\alpha$  varies.
6. Suppose that  $S_j$  is a homogeneous syzygy of multidegree  $\gamma_j$  in  $S(G)$ . Then show that  $S_j \cdot G$  has multidegree  $< \gamma_j$ . This implies that  $x^{\delta - \gamma_i} S_j \cdot G$  has multidegree  $< \delta$ , which is a fact we need for the proof of Theorem 9.
7. Complete the proof of Proposition 10 by proving the formula expressing  $S_{ij}$  in terms of  $S_{ik}$  and  $S_{jk}$ .
8. Let  $G$  be a finite subset of  $k[x_1, \dots, x_n]$  and let  $f \in \langle G \rangle$ . If  $\bar{f}^G = r \neq 0$ , then show that  $F \rightarrow_{G'} 0$ , where  $G' = G \cup \{r\}$ . This fact is used in the proof of Theorem 11.
9. In the proof of Theorem 11, we claimed that for every value of  $B$ , if  $1 \leq i < j \leq t$  and  $(i, j) \notin B$ , then condition (8) was true. To prove this, we needed to show that if the claim held for  $B$ , then it held when  $B$  changed to some  $B'$ . The case when  $(i, j) \notin B'$  but  $(i, j) \in B$  was covered in the text. It remains to consider when  $(i, j) \notin B' \cup B$ . In this case, prove that (8) holds for  $B'$ . Hint: Note that (8) holds for  $B$ . There are two cases to consider, depending on whether  $B'$  is bigger or smaller than  $B$ . In the latter situation,  $B' = B - \{(k, l)\}$  for some  $(k, l) \neq (i, j)$ .
10. In this exercise, we will study the ordering on the set  $\{(i, j) : 1 \leq i < j \leq t\}$  described in the proof of Theorem 11. Assume that  $B = \emptyset$ , and recall that  $t$  is the length of  $G$  when the algorithm stops.
  - a. Show that any pair  $(i, j)$  with  $1 \leq i < j \leq t$  was a member of  $B$  at some point during the algorithm.
  - b. Use part (a) and  $B = \emptyset$  to explain how we can order the set of *all* pairs according to when a pair was removed from  $B$ .
11. Consider  $f_1 = x^3 - 2xy$  and  $f_2 = x^2y - 2y^2 + x$  and use grlex order on  $k[x, y]$ . These polynomials are taken from Example 1 of §7, where we followed Buchberger's algorithm to show how a Groebner basis was produced. Redo this example using the algorithm of Theorem 11 and, in particular, keep track of how many times you have to use the division algorithm.
12. Consider the polynomials

$$x^{n+1} - yz^{n-1}w, \quad xy^{n-1} - z^n, \quad x^n z - y^n w,$$

and use grevlex order with  $x > y > z > w$ . Mora [see LAZARD (1983)] showed that the reduced Groebner basis contains the polynomial

$$z^{n^2+1} - y^{n^2} w.$$

Prove that this is true when  $n$  is 3, 4, or 5. How big are the Groebner bases?

13. In this exercise, we will look at some examples of how the term order can affect the length of a Groebner basis computation and the complexity of the answer.
- Compute a Groebner basis for  $I = \langle x^5 + y^4 + z^3 - 1, x^3 + y^2 + z^2 - 1 \rangle$  using lex and grevlex orders with  $x > y > z$ . You may not notice any difference in the computation time, but you will see that the Groebner basis is much simpler when using grevlex.
  - Compute a Groebner basis for  $I = \langle x^5 + y^4 + z^3 - 1, x^3 + y^3 + z^2 - 1 \rangle$  using lex and grevlex orders with  $x > y > z$ . This differs from the previous example by a single exponent, but the Groebner basis for lex order is significantly nastier (one of its polynomials has 282 terms, total degree 25, and a largest coefficient of 170255391). Depending on the computer and how the algorithm was implemented, the computation for lex order may take dramatically longer.
  - Let  $I = \langle x^4 - yz^2w, xy^2 - z^3, x^3z - y^3w \rangle$  be the ideal generated by the polynomials of Exercise 12 with  $n = 3$ . Using lex and grevlex orders with  $x > y > z > w$ , show that the resulting Groebner bases are the same. So grevlex is not always better than lex, but in practice, it is usually a good idea to use grevlex whenever possible.

# 3

## Elimination Theory

This chapter will study systematic methods for eliminating variables from systems of polynomial equations. The basic strategy of elimination theory will be given in two main theorems: the Elimination Theorem and the Extension Theorem. We will prove these results using Groebner bases and the classic theory of resultants. The geometric interpretation of elimination will also be explored when we discuss the Closure Theorem. Of the many applications of elimination theory, we will treat two in detail: the implicitization problem and the envelope of a family of curves.

### §1 The Elimination and Extension Theorems

To get a sense of how elimination works, let us look at an example similar to those discussed at the end of Chapter 2. We will solve the system of equations

$$(1) \quad \begin{aligned} x^2 + y + z &= 1, \\ x + y^2 + z &= 1, \\ x + y + z^2 &= 1. \end{aligned}$$

If we let  $I$  be the ideal

$$(2) \quad I = \langle x^2 + y + z - 1, x + y^2 + z - 1, x + y + z^2 - 1 \rangle,$$

then a Groebner basis for  $I$  with respect to lex order is given by the four polynomials

$$(3) \quad \begin{aligned} g_1 &= x + y + z^2 - 1, \\ g_2 &= y^2 - y - z^2 + z, \\ g_3 &= 2yz^2 + z^4 - z^2, \\ g_4 &= z^6 - 4z^4 + 4z^3 - z^2. \end{aligned}$$

It follows that equations (1) and (3) have the same solutions. However, since

$$g_4 = z^6 - 4z^4 + 4z^3 - z^2 = z^2(z - 1)^2(z^2 + 2z - 1)$$

involves only  $z$ , we see that the possible  $z$ 's are 0, 1 and  $-1 \pm \sqrt{2}$ . Substituting these values into  $g_2 = y^2 - y - z^2 + z = 0$  and  $g_3 = 2yz^2 + z^4 - z^2 = 0$ , we can determine

the possible  $y$ 's, and then finally  $g_1 = x + y + z^2 - 1 = 0$  gives the corresponding  $x$ 's. In this way, one can check that equations (1) have exactly five solutions:

$$\begin{aligned} &(1, 0, 0), (0, 1, 0), (0, 0, 1), \\ &(-1 + \sqrt{2}, -1 + \sqrt{2}, -1 + \sqrt{2}), \\ &(-1 - \sqrt{2}, -1 - \sqrt{2}, -1 - \sqrt{2}). \end{aligned}$$

What enabled us to find these solutions? There were two things that made our success possible:

- (Elimination Step) We could find a consequence  $g_4 = z^6 - 4z^4 + 4z^3 - z^2 = 0$  of our original equations which involved only  $z$ , i.e., we eliminated  $x$  and  $y$  from the system of equations.
- (Extension Step) Once we solved the simpler equation  $g_4 = 0$  to determine the values of  $z$ , we could extend these solutions to solutions of the original equations.

The basic idea of *elimination theory* is that both the Elimination Step and the Extension Step can be done in great generality.

To see how the Elimination Step works, notice that our observation concerning  $g_4$  can be written

$$g_4 \in I \cap \mathbb{C}[z],$$

where  $I$  is the ideal given in equation (2). In fact,  $I \cap \mathbb{C}[z]$  consists of *all* consequences of our equations which eliminate  $x$  and  $y$ . Generalizing this idea leads to the following definition.

**Definition 1.** Given  $I = \langle f_1, \dots, f_s \rangle \subset k[x_1, \dots, x_n]$  the  $l$ -th **elimination ideal**  $I_l$  is the ideal of  $k[x_{l+1}, \dots, x_n]$  defined by

$$I_l = I \cap k[x_{l+1}, \dots, x_n].$$

Thus,  $I_l$  consists of all consequences of  $f_1 = \dots = f_s = 0$  which eliminate the variables  $x_1, \dots, x_l$ . In the exercises, you will verify that  $I_l$  is an ideal of  $k[x_{l+1}, \dots, x_n]$ . Note that  $I = I_0$  is the 0th elimination ideal. Also observe that different orderings of the variables lead to different elimination ideals.

Using this language, we see that eliminating  $x_1, \dots, x_l$  means finding nonzero polynomials in the  $l$ -th elimination ideal  $I_l$ . Thus a *solution of the Elimination Step* means giving a systematic procedure for finding elements of  $I_l$ . With the proper term ordering, Groebner bases allow us to do this instantly.

**Theorem 2 (The Elimination Theorem).** Let  $I \subset k[x_1, \dots, x_n]$  be an ideal and let  $G$  be a Groebner basis of  $I$  with respect to *lex order* where  $x_1 > x_2 > \dots > x_n$ . Then, for every  $0 \leq l \leq n$ , the set

$$G_l = G \cap k[x_{l+1}, \dots, x_n]$$

is a Groebner basis of the  $l$ -th elimination ideal  $I_l$ .

**Proof.** Fix  $l$  between 0 and  $n$ . Since  $G_l \subset I_l$  by construction, it suffices to show that

$$\langle \text{LT}(I_l) \rangle = \langle \text{LT}(G_l) \rangle$$

by the definition of Groebner basis. One inclusion is obvious, and to prove the other inclusion  $\langle \text{LT}(I_l) \rangle \subset \langle \text{LT}(G_l) \rangle$ , we need only show that the leading term  $\text{LT}(f)$ , for an arbitrary  $f \in I_l$ , is divisible by  $\text{LT}(g)$  for some  $g \in G_l$ .

To prove this, note that  $f$  also lies in  $I$ , which tells us that  $\text{LT}(f)$  is divisible by  $\text{LT}(g)$  for some  $g \in G$  since  $G$  is a Groebner basis of  $I$ . Since  $f \in I_l$ , this means that  $\text{LT}(g)$  involves only the variables  $x_{l+1}, \dots, x_n$ . Now comes the crucial observation: since we are using lex order with  $x_1 > \dots > x_n$ , any monomial involving  $x_1, \dots, x_l$  is greater than all monomials in  $k[x_{l+1}, \dots, x_n]$ , so that  $\text{LT}(g) \in k[x_{l+1}, \dots, x_n]$  implies  $g \in k[x_{l+1}, \dots, x_n]$ . This shows that  $g \in G_l$ , and the theorem is proved.  $\square$

For an example of how this theorem works, let us return to example (1) from the beginning of the section. Here,  $I = \langle x^2 + y + z - 1, x + y^2 + z - 1, x + y + z^2 - 1 \rangle$ , and a Groebner basis with respect to lex order is given in (3). It follows from the Elimination Theorem that

$$\begin{aligned} I_1 &= I \cap \mathbb{C}[y, z] = \langle y^2 - y - z^2 + z, 2yz^2 + z^4 - z^2, z^6 - 4z^4 + 4z^3 - z^2 \rangle, \\ I_2 &= I \cap \mathbb{C}[z] = \langle z^6 - 4z^4 + 4z^3 - z^2 \rangle. \end{aligned}$$

Thus,  $g_4 = z^6 - 4z^4 + 4z^3 - z^2$  is not just some random way of eliminating  $x$  and  $y$  from our equations—it is the best possible way to do so since any other polynomial that eliminates  $x$  and  $y$  is a multiple of  $g_4$ .

The Elimination Theorem shows that a Groebner basis for lex order eliminates not only the first variable, but also the first two variables, the first three variables, and so on. In some cases (such as the implicitization problem to be studied in §3), we only want to eliminate certain variables, and we do not care about the others. In such a situation, it is a bit of overkill to compute a Groebner basis using lex order. This is especially true since lex order can lead to some very unpleasant Groebner bases (see Exercise 13 of Chapter 2, §9 for an example). In the exercises, you will study versions of the Elimination Theorem that use more efficient monomial orderings than lex.

We next discuss the Extension Step. Suppose that we have an ideal  $I \subset k[x_1, \dots, x_n]$ . As in Chapter 2, we have the affine variety

$$\mathbf{V}(I) = \{(a_1, \dots, a_n) \in k^n : f(a_1, \dots, a_n) = 0 \text{ for all } f \in I\}.$$

To describe points of  $\mathbf{V}(I)$ , the basic idea is to build up solutions one coordinate at a time. Fix some  $l$  between 1 and  $n$ . This gives us the elimination ideal  $I_l$ , and we will call a solution  $(a_{l+1}, \dots, a_n) \in \mathbf{V}(I_l)$  a *partial solution* of the original system of equations. To extend  $(a_{l+1}, \dots, a_n)$  to a complete solution in  $\mathbf{V}(I)$ , we first need to add one more coordinate to the solution. This means finding  $a_l$  so that  $(a_l, a_{l+1}, \dots, a_n)$  lies in the variety  $\mathbf{V}(I_{l-1})$  of the next elimination ideal. More concretely, suppose that  $I_{l-1} = \langle g_1, \dots, g_r \rangle$  in  $k[x_l, x_{l+1}, \dots, x_n]$ . Then we want to find solutions  $x_l = a_l$  of the equations

$$g_1(x_l, a_{l+1}, \dots, a_n) = \dots = g_r(x_l, a_{l+1}, \dots, a_n) = 0.$$

Here we are dealing with polynomials of one variable  $x_i$ , and it follows that the possible  $a_i$ 's are just the roots of the GCD of the above  $r$  polynomials.

The basic problem is that the above polynomials may not have a common root, i.e., there may be some partial solutions which do not extend to complete solutions. For a simple example, consider the equations

$$(4) \quad \begin{aligned} xy &= 1, \\ xz &= 1. \end{aligned}$$

Here,  $I = \langle xy - 1, xz - 1 \rangle$ , and an easy application of the Elimination Theorem shows that  $y - z$  generates the first elimination ideal  $I_1$ . Thus, the partial solutions are given by  $(a, a)$ , and these all extend to complete solutions  $(1/a, a, a)$  *except* for the partial solution  $(0, 0)$ . To see what is going on geometrically, note that  $y = z$  defines a plane in 3-dimensional space. Then the variety (4) is a hyperbola lying in this plane:

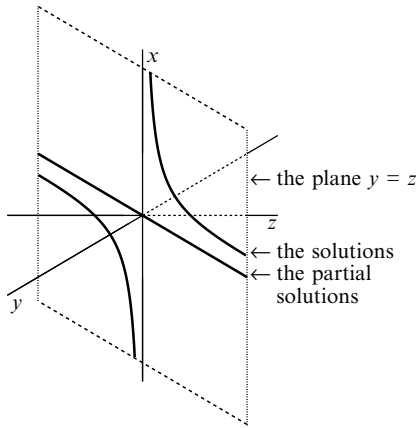

It is clear that the variety defined by (4) has no points lying over the partial solution  $(0,0)$ . Pictures such as the one here will be studied in more detail in §2 when we study the geometric interpretation of eliminating variables. For now, our goal is to see if we can determine *in advance* which partial solutions extend to complete solutions.

Let us restrict our attention to the case where we eliminate just the first variable  $x_1$ . Thus, we want to know if a partial solution  $(a_2, \dots, a_n) \in \mathbf{V}(I_1)$  can be extended to a solution  $(a_1, a_2, \dots, a_n) \in \mathbf{V}(I)$ . The following theorem tells us when this can be done.

**Theorem 3 (The Extension Theorem).** *Let  $I = \langle f_1, \dots, f_s \rangle \subset \mathbb{C}[x_1, \dots, x_n]$  and let  $I_1$  be the first elimination ideal of  $I$ . For each  $1 \leq i \leq s$ , write  $f_i$  in the form*

$$f_i = g_i(x_2, \dots, x_n)x_1^{N_i} + \text{terms in which } x_1 \text{ has degree } < N_i,$$

where  $N_i \geq 0$  and  $g_i \in \mathbb{C}[x_2, \dots, x_n]$  is nonzero. Suppose that we have a partial solution  $(a_2, \dots, a_n) \in \mathbf{V}(I_1)$ . If  $(a_2, \dots, a_n) \notin \mathbf{V}(g_1, \dots, g_s)$ , then there exists  $a_1 \in \mathbb{C}$  such that  $(a_1, a_2, \dots, a_n) \in \mathbf{V}(I)$ .

The proof of this theorem uses resultants and will be given in §6. For the rest of the section, we will explain the Extension Theorem and discuss its consequences. A geometric interpretation will be given in §2.

A first observation is that the theorem is stated only for the field  $k = \mathbb{C}$ . To see why  $\mathbb{C}$  is important, assume that  $k = \mathbb{R}$  and consider the equations

$$(5) \quad \begin{aligned} x^2 &= y, \\ x^2 &= z. \end{aligned}$$

Eliminating  $x$  gives  $y = z$ , so that we get the partial solutions  $(a, a)$  for all  $a \in \mathbb{R}$ . Since the leading coefficients of  $x$  in  $x^2 - y$  and  $x^2 - z$  never vanish, the Extension Theorem guarantees that  $(a, a)$  extends, *provided* we work over  $\mathbb{C}$ . Over  $\mathbb{R}$ , the situation is different. Here,  $x^2 = a$  has no real solutions when  $a$  is negative, so that only those partial solutions with  $a \geq 0$  extend to real solutions of (5). This shows that the Extension Theorem is false over  $\mathbb{R}$ .

Turning to the hypothesis  $(a_2, \dots, a_n) \notin \mathbf{V}(g_1, \dots, g_s)$ , note that the  $g_i$ 's are the leading coefficients with respect to  $x_1$  of the  $f_i$ 's. Thus,  $(a_2, \dots, a_n) \notin \mathbf{V}(g_1, \dots, g_s)$  says that the leading coefficients do not vanish simultaneously at the partial solution. To see why this condition is necessary, let us look at example (4). Here, the equations

$$\begin{aligned} xy &= 1, \\ xz &= 1 \end{aligned}$$

have the partial solutions  $(y, z) = (a, a)$ . The only one that does not extend is  $(0, 0)$ , which is the partial solution where the leading coefficients  $y$  and  $z$  of  $x$  vanish. The Extension Theorem tells us that *the Extension Step can fail only when the leading coefficients vanish simultaneously*.

Finally, we should mention that the variety  $\mathbf{V}(g_1, \dots, g_s)$  where the leading coefficients vanish depends on the basis  $\{f_1, \dots, f_s\}$  of  $I$ : changing to a different basis may cause  $\mathbf{V}(g_1, \dots, g_s)$  to change. In Chapter 8, we will learn how to choose  $(f_1, \dots, f_s)$  so that  $\mathbf{V}(g_1, \dots, g_s)$  is as small as possible. We should also point out that if one works in projective space (to be defined in Chapter 8), then one can show that *all* partial solutions extend.

Although the Extension Theorem is stated only for the case of eliminating the first variable  $x_1$ , it can be used when eliminating any number of variables. For example, consider the equations

$$(6) \quad \begin{aligned} x^2 + y^2 + z^2 &= 1, \\ xyz &= 1. \end{aligned}$$

A Groebner basis for  $I = \langle x^2 + y^2 + z^2 - 1, xyz - 1 \rangle$  with respect to lex order is

$$\begin{aligned} g_1 &= y^4 z^2 + y^2 z^4 - y^2 z^2 + 1, \\ g_2 &= x + y^3 z + yz^3 - yz. \end{aligned}$$



By the Elimination Theorem, we obtain

$$\begin{aligned} I_1 &= I \cap \mathbb{C}[y, z] = \langle g_1 \rangle, \\ I_2 &= I \cap \mathbb{C}[z] = \{0\}. \end{aligned}$$

Since  $I_2 = \{0\}$ , we have  $\mathbf{V}(I_2) = \mathbb{C}$ , and, thus, every  $c \in \mathbb{C}$  is a partial solution. So we ask:

Which partial solutions  $c \in \mathbb{C} = \mathbf{V}(I_2)$  extend to  $(a, b, c) \in \mathbf{V}(I)$ ?

The idea is to extend  $c$  one coordinate at a time: first to  $(b, c)$ , then to  $(a, b, c)$ . To control which solutions extend, we will use the Extension Theorem at each step. The crucial observation is that  $I_2$  is the first elimination ideal of  $I_1$ . This is easy to see here, and the general case is covered in the exercises. Thus, we will use the Extension Theorem once to go from  $c \in \mathbf{V}(I_2)$  to  $(b, c) \in \mathbf{V}(I_1)$ , and a second time to go to  $(a, b, c) \in \mathbf{V}(I)$ . This will tell us exactly which  $c$ 's extend.

To start, we apply the Extension Theorem to go from  $I_2$  to  $I_1 = \langle g_1 \rangle$ . The coefficient of  $y^4$  in  $g_1$  is  $z^2$ , so that  $c \in \mathbb{C} = \mathbf{V}(I_2)$  extends to  $(b, c)$  whenever  $c \neq 0$ . Note also that  $g_1 = 0$  has no solution when  $c = 0$ . The next step is to go from  $I_1$  to  $I$ ; that is, to find  $a$  so that  $(a, b, c) \in \mathbf{V}(I)$ . If we substitute  $(y, z) = (b, c)$  into (6), we get two equations in  $x$ , and it is not obvious that there is a common solution  $x = a$ . This is where the Extension Theorem shows its power. The leading coefficients of  $x$  in  $x^2 + y^2 + z^2 - 1$  and  $xyz - 1$  are 1 and  $yz$ , respectively. Since 1 never vanishes, the Extension Theorem *guarantees* that  $a$  always exists. We have thus proved that *all* partial solutions  $c \neq 0$  extend to  $\mathbf{V}(I)$ .

The Extension Theorem is especially easy to use when one of the leading coefficients is constant. This case is sufficiently useful that we will state it as a separate corollary.

**Corollary 4.** *Let  $I = \langle f_1, \dots, f_s \rangle \subset \mathbb{C}[x_1, \dots, x_n]$ , and assume that for some  $i$ ,  $f_i$  is of the form*

$$f_i = cx_1^N + \text{terms in which } x_1 \text{ has degree } < N,$$

*where  $c \in \mathbb{C}$  is nonzero and  $N > 0$ . If  $I_1$  is the first elimination ideal of  $I$  and  $(a_2, \dots, a_n) \in \mathbf{V}(I_1)$ , then there is  $a_1 \in \mathbb{C}$  so that  $(a_1, a_2, \dots, a_n) \in \mathbf{V}(I)$ .*

**Proof.** This follows immediately from the Extension Theorem: since  $g_i = c \neq 0$  implies  $\mathbf{V}(g_1, \dots, g_s) = \emptyset$ , we have  $(a_2, \dots, a_n) \notin \mathbf{V}(g_1, \dots, g_s)$  for all partial solutions.  $\square$

We will end this section with an example of a system of equations that does not have nice solutions. Consider the equations

$$\begin{aligned} xy &= 4, \\ y^2 &= x^3 - 1. \end{aligned}$$

Using lex order, the Groebner basis is given by

$$\begin{aligned}g_1 &= 16x - y^2 - y^4, \\g_2 &= y^5 + y^3 - 64,\end{aligned}$$

but if we proceed as usual, we discover that  $y^5 + y^3 - 64$  has *no* rational roots (in fact, it is *irreducible* over  $\mathbb{Q}$ , a concept we will discuss in §5). One option is to compute the roots numerically. A variety of methods (such as the Newton-Raphson method) are available, and for  $y^5 + y^3 - 64 = 0$ , one obtains

$$y = 2.21363, -1.78719 \pm 1.3984i, \text{ or } 0.680372 \pm 2.26969i.$$

These solutions can then be substituted into  $g_1 = 16x - y^2 - y^4 = 0$  to determine the values of  $x$ . Thus, unlike the previous examples, we can only find numerical approximations to the solutions.

There are many interesting problems that arise when one tries to find numerical solutions of polynomial equations. For further reading on this topic, we recommend LAZARD (1993) and MANOCHA (1994). The reader may also wish to consult COX, LITTLE and O'SHEA (1998), MIGNOTTE (1992) and MISHRA (1993).

### EXERCISES FOR §1

- Let  $I \subset k[x_1, \dots, x_n]$  be an ideal.
  - Prove that  $I_l = I \cap k[x_{l+1}, \dots, x_n]$  is an ideal of  $k[x_{l+1}, \dots, x_n]$ .
  - Prove that the ideal  $I_{l+1} \subset k[x_{l+2}, \dots, x_n]$  is the first elimination ideal of  $I_l \subset k[x_{l+1}, \dots, x_n]$ . This observation allows us to use the Extension Theorem multiple times when eliminating more than one variable.
- Consider the system of equations

$$\begin{aligned}x^2 + 2y^2 &= 3, \\x^2 + xy + y^2 &= 3.\end{aligned}$$

- If  $I$  is the ideal generated by these equations, find bases of  $I \cap k[x]$  and  $I \cap k[y]$ .
  - Find all solutions of the equations.
  - Which of the solutions are *rational*, i.e., lie in  $\mathbb{Q}^2$ ?
  - What is the smallest field  $k$  containing  $\mathbb{Q}$  such that all solutions lie in  $k^2$ ?
3. Determine all solutions  $(x, y) \in \mathbb{Q}^2$  of the system of equations

$$\begin{aligned}x^2 + 2y^2 &= 2 \\x^2 + xy + y^2 &= 2.\end{aligned}$$

Also determine all solutions in  $\mathbb{C}^2$ .

4. Find bases for the elimination ideals  $I_1$  and  $I_2$  for the ideal  $I$  determined by the equations:

$$\begin{aligned}x^2 + y^2 + z^2 &= 4, \\x^2 + 2y^2 &= 5, \\xz &= 1.\end{aligned}$$

How many rational (i.e., in  $\mathbb{Q}^3$ ) solutions are there?

5. In this exercise, we will prove a more general version of the Elimination Theorem. Fix an integer  $1 \leq l \leq n$ . We say that a monomial order  $>$  on  $k[x_1, \dots, x_n]$  is of *l-elimination*

type provided that any monomial involving one of  $x_1, \dots, x_l$  is greater than all monomials in  $k[x_{l+1}, \dots, x_n]$ . Prove the following generalized Elimination Theorem. If  $I$  is an ideal in  $k[x_1, \dots, x_n]$  and  $G$  is a Groebner basis of  $I$  with respect to a monomial order of  $l$ -elimination type, then  $G \cap k[x_{l+1}, \dots, x_n]$  is a basis of the  $l$ th elimination ideal  $I \cap k[x_{l+1}, \dots, x_n]$ .

6. To exploit the generalized Elimination Theorem of Exercise 5, we need some interesting examples of monomial orders of  $l$ -elimination type. We will consider two such orders.
- a. Fix an integer  $1 \leq l \leq n$ , and define the order  $>_l$  as follows: if  $\alpha, \beta \in \mathbb{Z}_{\geq 0}^n$ , then  $\alpha >_l \beta$  if

$$\alpha_1 + \dots + \alpha_l > \beta_1 + \dots + \beta_l, \text{ or } \alpha_1 + \dots + \alpha_l = \beta_1 + \dots + \beta_l \text{ and } \alpha >_{\text{grevlex}} \beta.$$

This is the  $l$ -th *elimination order* of BAYER and STILLMAN (1987b). Prove that  $>_l$  is a monomial order and is of  $l$ -elimination type. Hint: If you did Exercise 12 of Chapter 2, §4, then you have already done this problem.

- b. In Exercise 10 of Chapter 2, §4, we considered an example of a product order that mixed lex and grevlex orders on different sets of variables. Explain how to create a product order that induces grevlex on both  $k[x_1, \dots, x_l]$  and  $k[x_{l+1}, \dots, x_n]$  and show that this order is of  $l$ -elimination type.
- c. If  $G$  is a Groebner basis for  $I \subset k[x_1, \dots, x_n]$  for either of the monomial orders of parts a or b, explain why  $G \cap k[x_{l+1}, \dots, x_n]$  is a Groebner basis with respect to grevlex.
7. Consider the equations

$$\begin{aligned} t^2 + x^2 + y^2 + z^2 &= 0, \\ t^2 + 2x^2 - xy - z^2 &= 0, \\ t + y^3 - z^3 &= 0. \end{aligned}$$

We want to eliminate  $t$ . Let  $I = \langle t^2 + x^2 + y^2 + z^2, t^2 + 2x^2 - xy - z^2, t + y^3 - z^3 \rangle$  be the corresponding ideal.

- a. Using lex order with  $t > x > y > z$ , compute a Groebner basis for  $I$ , and then find a basis for  $I \cap k[x, y, z]$ . You should get four generators, one of which has total degree 12.
- b. Use grevlex to compute a Groebner basis for  $I \cap k[x, y, z]$ . You will get a simpler set of two generators.
- c. Combine the answer to part b with the polynomial  $t + y^3 - z^3$  and show that this gives a Groebner basis for  $I$  with respect to the elimination order  $>_1$  (this is  $>_l$  with  $l = 1$ ) of Exercise 6. Notice that this Groebner basis is much simpler than the one found in part a. If you have access to a computer algebra system that knows elimination orders, then check your answer.
8. In equation (6), we showed that  $z \neq 0$  could be specified arbitrarily. Hence,  $z$  can be regarded as a “parameter.” To emphasize this point, show that there are formulas for  $x$  and  $y$  in terms of  $z$ . Hint: Use  $g_1$  and the quadratic formula to get  $y$  in terms of  $z$ . Then use  $xyz = 1$  to get  $x$ . The formulas you obtain give a “parametrization” of  $\mathbf{V}(I)$  which is different from those studied in §3 of Chapter 1. Namely, in Chapter 1, we used parametrizations by *rational* functions, whereas here, we have what is called a parametrization by *algebraic* functions. Note that  $x$  and  $y$  are *not* uniquely determined by  $z$ .
9. Consider the system of equations given by

$$\begin{aligned} x^5 + \frac{1}{x^5} &= y, \\ x + \frac{1}{x} &= z. \end{aligned}$$

Let  $I$  be the ideal in  $\mathbb{C}[x, y, z]$  determined by these equations.

- a. Find a basis of  $I_1 \subset \mathbb{C}[y, z]$  and show that  $I_2 = \{0\}$ .
- b. Use the Extension Theorem to prove that each partial solution  $c \in \mathbf{V}(I_2) = \mathbb{C}$  extends to a solution in  $\mathbf{V}(I) \subset \mathbb{C}^3$ .
- c. Which partial solutions  $(y, z) \in \mathbf{V}(I_1) \subset \mathbb{R}^2$  extend to solutions in  $\mathbf{V}(I) \subset \mathbb{R}^3$ . Explain why your answer does not contradict the Extension Theorem.
- d. If we regard  $z$  as a “parameter” (see the previous problem), then solve for  $x$  and  $y$  as algebraic functions of  $z$  to obtain a “parametrization” of  $\mathbf{V}(I)$ .

## §2 The Geometry of Elimination

In this section, we will give a geometric interpretation of the theorems proved in §1. The main idea is that elimination corresponds to projecting a variety onto a lower dimensional subspace. We will also discuss the Closure Theorem, which describes the relation between partial solutions and elimination ideals. For simplicity, we will work over the field  $k = \mathbb{C}$ .

Let us start by defining the projection of an affine variety. Suppose that we are given  $V = \mathbf{V}(f_1, \dots, f_s) \subset \mathbb{C}^n$ . To eliminate the first  $l$  variables  $x_1, \dots, x_l$ , we will consider the *projection map*

$$\pi_l : \mathbb{C}^n \rightarrow \mathbb{C}^{n-l}$$

which sends  $(a_1, \dots, a_n)$  to  $(a_{l+1}, \dots, a_n)$ . If we apply  $\pi_l$  to  $V \subset \mathbb{C}^n$ , then we get  $\pi_l(V) \subset \mathbb{C}^{n-l}$ . We can relate  $\pi_l(V)$  to the  $l$ -th elimination ideal as follows.

**Lemma 1.** *With the above notation, let  $I_l = \langle f_1, \dots, f_s \rangle \cap \mathbb{C}[x_{l+1}, \dots, x_n]$  be the  $l$ -th elimination ideal. Then, in  $\mathbb{C}^{n-l}$ , we have*

$$\pi_l(V) \subset \mathbf{V}(I_l).$$

**Proof.** Fix a polynomial  $f \in I_l$ . If  $(a_1, \dots, a_n) \in V$ , then  $f$  vanishes at  $(a_1, \dots, a_n)$  since  $f \in \langle f_1, \dots, f_s \rangle$ . But  $f$  involves only  $x_{l+1}, \dots, x_n$ , so that we can write

$$f(a_{l+1}, \dots, a_n) = f(\pi_l(a_1, \dots, a_n)) = 0.$$

This shows that  $f$  vanishes at all points of  $\pi_l(V)$ . □

As in §1, points of  $\mathbf{V}(I_l)$  will be called *partial solutions*. Using the lemma, we can write  $\pi_l(V)$  as follows:

$$\begin{aligned} \pi_l(V) = \{ & (a_{l+1}, \dots, a_n) \in \mathbf{V}(I_l) : \exists a_1, \dots, a_l \in \mathbb{C} \\ & \text{with } (a_1, \dots, a_l, a_{l+1}, \dots, a_n) \in V \}. \end{aligned}$$

Thus,  $\pi_l(V)$  consists *exactly* of the partial solutions that extend to complete solutions. For an example of this, consider the variety  $V$  defined by equations (4) from §1:

$$(1) \quad \begin{aligned} xy &= 1, \\ xz &= 1. \end{aligned}$$

Here, we have the following picture that simultaneously shows the solutions and the partial solutions:

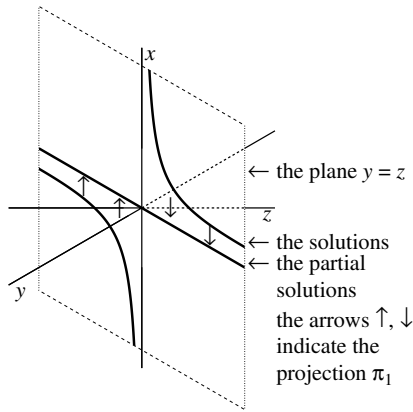

Note that  $\mathbf{V}(I_1)$  is the line  $y = z$  in the  $yz$ -plane, and that

$$\pi_1(V) = \{(a, a) \in \mathbb{C}^2 : a \neq 0\}.$$

In particular,  $\pi_1(V)$  is *not an affine variety*—it is missing the point  $(0, 0)$ .

The basic tool to understand the missing points is the Extension Theorem from §1. It only deals with  $\pi_1$  (i.e., eliminating  $x_1$ ), but gives us a good picture of what happens in this case. Stated geometrically, here is what the Extension Theorem says.

**Theorem 2 (The Geometric Extension Theorem).** *Given  $V = \mathbf{V}(f_1, \dots, f_s) \subset \mathbb{C}^n$ , let  $g_i$  be as in the Extension Theorem from §1. If  $I_1$  is the first elimination ideal of  $\langle f_1, \dots, f_s \rangle$ , then we have the equality in  $\mathbb{C}^{n-1}$*

$$\mathbf{V}(I_1) = \pi_1(V) \cup (\mathbf{V}(g_1, \dots, g_s) \cap \mathbf{V}(I_1)),$$

where  $\pi_1 : \mathbb{C}^n \rightarrow \mathbb{C}^{n-1}$  is projection onto the last  $n - 1$  components.

**Proof.** The proof follows from Lemma 1 and the Extension Theorem. The details will be left as an exercise. □

This theorem tells us that  $\pi_1(V)$  fills up the affine variety  $\mathbf{V}(I_1)$ , except possibly for a part that lies in  $\mathbf{V}(g_1, \dots, g_s)$ . Unfortunately, it is not clear how big this part is, and sometimes  $\mathbf{V}(g_1, \dots, g_s)$  is unnaturally large. For example, one can show that the equations

$$(2) \quad \begin{aligned} (y - z)x^2 + xy &= 1, \\ (y - z)x^2 + xz &= 1 \end{aligned}$$

generate the same ideal as equations (1). Since  $g_1 = g_2 = y - z$  generate the elimination ideal  $I_1$ , the Geometric Extension Theorem tells us *nothing* about the size of  $\pi_1(V)$  in this case.

Nevertheless, we can still make the following strong statements about the relation between  $\pi_l(V)$  and  $\mathbf{V}(I_l)$ .

**Theorem 3 (The Closure Theorem).** *Let  $V = \mathbf{V}(f_1, \dots, f_s) \subset \mathbb{C}^n$  and let  $I_l$  be the  $l$ -th elimination ideal of  $\langle f_1, \dots, f_s \rangle$ . Then:*

- (i)  $\mathbf{V}(I_l)$  is the smallest affine variety containing  $\pi_l(V) \subset \mathbb{C}^{n-l}$ .
- (ii) When  $V \neq \emptyset$ , there is an affine variety  $W \subsetneq \mathbf{V}(I_l)$  such that  $\mathbf{V}(I_l) - W \subset \pi_l(V)$ .

**Proof.** When we say “smallest variety” in part (i), we mean “smallest with respect to set-theoretic inclusion.” Thus,  $\mathbf{V}(I_l)$  being smallest means two things:

- $\pi_l(V) \subset \mathbf{V}(I_l)$
- If  $Z$  is *any other* affine variety in  $\mathbb{C}^{n-l}$  containing  $\pi_l(V)$ , then  $\mathbf{V}(I_l) \subset Z$ .

In Chapter 4, we will express this by saying that  $\mathbf{V}(I_l)$  is the *Zariski closure* of  $\pi_l(V)$ . This is where the theorem gets its name. We cannot yet prove part (i) of the theorem, for it requires the Nullstellensatz. The proof will be given in Chapter 4.

The second part of the theorem says that although  $\pi_l(V)$  may not equal  $\mathbf{V}(I_l)$ , it fills up “most” of  $\mathbf{V}(I_l)$  in the sense that what is missing lies in a strictly smaller affine variety. We will only prove this part of the theorem in the special case when  $l = 1$ . The proof when  $l > 1$  will be given in §6 of Chapter 5.

The main tool we will use is the decomposition

$$\mathbf{V}(I_1) = \pi_1(V) \cup (\mathbf{V}(g_1, \dots, g_s) \cap \mathbf{V}(I_1))$$

from the Geometric Extension Theorem. Let  $W = \mathbf{V}(g_1, \dots, g_s) \cap \mathbf{V}(I_1)$  and note that  $W$  is an affine variety by Lemma 2 of Chapter 1, §2. The above decomposition implies that  $\mathbf{V}(I_1) - W \subset \pi_1(V)$ , and thus we are done if  $W \neq \mathbf{V}(I_1)$ . However, as example (2) indicates, it can happen that  $W = \mathbf{V}(I_1)$ .

In this case, we need to change the equations defining  $V$  so that  $W$  becomes smaller. The key observation is that

$$(3) \quad \text{if } W = \mathbf{V}(I_1), \text{ then } V = \mathbf{V}(f_1, \dots, f_s, g_1, \dots, g_s).$$

This is proved as follows. First, since we are adding more equations, it is obvious that  $\mathbf{V}(f_1, \dots, f_s, g_1, \dots, g_s) \subset \mathbf{V}(f_1, \dots, f_s) = V$ . For the opposite inclusion, let  $(a_1, \dots, a_n) \in V$ . Certainly each  $f_i$  vanishes at this point, and since  $(a_2, \dots, a_n) \in \pi_1(V) \subset \mathbf{V}(I_1) = W$ , it follows that the  $g_i$ 's vanish here. Thus,  $(a_1, \dots, a_n) \in \mathbf{V}(f_1, \dots, f_s, g_1, \dots, g_s)$ , which completes the proof of (3).

Let  $I = \langle f_1, \dots, f_s \rangle$  be our original ideal and let  $\tilde{I}$  be the ideal  $\langle f_1, \dots, f_s, g_1, \dots, g_s \rangle$ . Notice that  $I$  and  $\tilde{I}$  may be different, even though they have the same variety  $V$  [proved in (3) above]. Thus, the corresponding elimination ideals  $I_1$  and  $\tilde{I}_1$  may differ. However, since  $\mathbf{V}(I_1)$  and  $\mathbf{V}(\tilde{I}_1)$  are both the smallest variety containing  $\pi_1(V)$  [by part (i) of the theorem], it follows that  $\mathbf{V}(I_1) = \mathbf{V}(\tilde{I}_1)$ .

The next step is to find a better basis of  $\tilde{I}$ . First, recall that the  $g_i$ 's are defined by writing

$$f_i = g_i(x_2, \dots, x_n)x_1^{N_i} + \text{terms in which } x_1 \text{ has degree } < N_i,$$

where  $N_i \geq 0$  and  $g_i \in \mathbb{C}[x_2, \dots, x_n]$  is nonzero. Now set

$$\tilde{f}_i = f_i - g_i x_1^{N_i}.$$

For each  $i$ , note that  $\tilde{f}_i$  is either zero or has strictly smaller degree in  $x_1$  than  $f_i$ . We leave it as an exercise to show that

$$\tilde{I} = \langle \tilde{f}_1, \dots, \tilde{f}_s, g_1, \dots, g_s \rangle.$$

Now apply the Geometric Extension Theorem to  $V = \mathbf{V}(\tilde{f}_1, \dots, \tilde{f}_s, g_1, \dots, g_s)$ . Note that the leading coefficients of the generators are different, so that we get a different decomposition

$$\mathbf{V}(I_1) = \mathbf{V}(\tilde{I}_1) = \pi_1(V) \cup \tilde{W},$$

where  $\tilde{W}$  consists of those partial solutions where the leading coefficients of  $\tilde{f}_1, \dots, \tilde{f}_s, g_1, \dots, g_s$  vanish.

Before going further with the proof, let us give an example to illustrate how  $\tilde{W}$  can be smaller than  $W$ . As in example (2), let  $I = \langle (y-z)x^2 + xy - 1, (y-z)x^2 + xz - 1 \rangle$ . We know that  $I_1 = \langle y-z \rangle$  and  $g_1 = g_2 = y-z$ , so that  $W = \mathbf{V}(I_1)$  in this case. Then it is easy to check that the process described earlier yields the ideal

$$\tilde{I} = \langle (y-z)x^2 + xy - 1, (y-z)x^2 + xz - 1, y-z \rangle = \langle xy - 1, xz - 1, y-z \rangle.$$

Applying the Geometric Extension Theorem to  $\tilde{I}$ , one finds that  $\tilde{W}$  consists of the partial solutions where  $y$  and  $z$  vanish, i.e.,  $\tilde{W} = \{(0, 0)\}$ , which is strictly smaller than  $W = \mathbf{V}(I_1)$ .

Unfortunately, in the general case, there is nothing to guarantee that  $\tilde{W}$  will be strictly smaller. So it still could happen that  $\tilde{W} = \mathbf{V}(I_1)$ . If this is the case, we simply repeat the above process. If at any subsequent stage we get something strictly smaller than  $\mathbf{V}(I_1)$ , then we are done.

It remains to consider what happens when we *always* get  $\mathbf{V}(I_1)$ . Each time we do the above process, the degrees in  $x_1$  of the generators drop (or remain at zero), so that eventually all of the generators will have degree 0 in  $x_1$ . This means that  $V$  can be defined by the vanishing of polynomials in  $\mathbb{C}[x_2, \dots, x_n]$ . Thus, if  $(a_2, \dots, a_n)$  is a partial solution, it follows that  $(a_1, a_2, \dots, a_n) \in V$  for *any*  $a_1 \in \mathbb{C}$  since  $x_1$  does not appear in the defining equations. Hence *every* partial solution extends, which proves that  $\pi_1(V) = \mathbf{V}(I_1)$ . In this case, we see that part (ii) of the theorem is satisfied when  $W = \emptyset$  (this is where we use the assumption  $V \neq \emptyset$ ). The theorem is now proved.  $\square$

The Closure Theorem gives us a partial description of  $\pi_l(V)$  since it fills up  $\mathbf{V}(I_l)$ , except for some missing points that lie in a variety strictly smaller than  $\mathbf{V}(I_l)$ . Unfortunately, the missing points might not fill up all of the smaller variety. The precise structure

of  $\pi_1(V)$  can be described as follows: there are affine varieties  $Z_i \subset W_i \subset \mathbb{C}^{n-1}$  for  $1 \leq i \leq m$  such that

$$\pi_1(V) = \bigcup_{i=1}^m (W_i - Z_i).$$

In general, a set of this form is called *constructible*. We will prove this in §6 of Chapter 5.

In §1, we saw that the nicest case of the Extension Theorem was when one of the leading coefficients  $g_i$  was a nonzero constant. Then the  $g_i$ 's can *never* simultaneously vanish at a point  $(a_2, \dots, a_n)$ , and, consequently, partial solutions *always* extend in this case. Thus, we have the following geometric version of Corollary 4 of §1.

**Corollary 4.** *Let  $V = \mathbf{V}(f_1, \dots, f_s) \subset \mathbb{C}^n$ , and assume that for some  $i$ ,  $f_i$  is of the form*

$$f_i = cx_1^N + \text{terms in which } x_1 \text{ has degree } < N,$$

where  $c \in \mathbb{C}$  is nonzero and  $N > 0$ . If  $I_1$  is the first elimination ideal, then in  $\mathbb{C}^{n-1}$

$$\pi_1(V) = \mathbf{V}(I_1),$$

where  $\pi_1$  is the projection on the last  $n - 1$  components.

A final point we need to make concerns fields. The Extension Theorem and the Closure Theorem (and their corollaries) are stated for the field of complex numbers  $\mathbb{C}$ . In §6, we will see that the Extension Theorem actually holds for any *algebraically closed* field  $k$ , and in Chapter 4, we will show that the same is true for the Closure Theorem.

**EXERCISES FOR §2**

1. Prove the Geometric Extension Theorem (Theorem 2) using the Extension Theorem and Lemma 1.
2. In example (2), verify carefully that  $\langle (y-z)x^2 + xy - 1, (y-z)x^2 + xz - 1 \rangle = \langle xy - 1, xz - 1 \rangle$ . Also check that  $y - z$  vanishes at all partial solutions in  $\mathbf{V}(I_1)$ .
3. In this problem, we will work through the proof of Theorem 3 in the special case when  $I = \langle f_1, f_2, f_3 \rangle$ , where

$$\begin{aligned} f_1 &= yx^3 + x^2, \\ f_2 &= y^3x^2 + y^2, \\ f_3 &= yx^4 + x^2 + y^2. \end{aligned}$$

- a. Find a Groebner basis for  $I$  and show that  $I_1 = \langle y^2 \rangle$ .
- b. Show that  $\mathbf{V}(I_1) = \mathbf{V}(I_1) \cap \mathbf{V}(g_1, g_2, g_3)$ , where  $g_i$  is the coefficient of the highest power of  $x$  in  $f_i$ . In the notation of Theorem 3, this is a case when  $W = \mathbf{V}(I_1)$ .
- c. Let  $\tilde{I} = \langle f_1, f_2, f_3, g_1, g_2, g_3 \rangle$ . Show that  $I \neq \tilde{I}$  and that  $\mathbf{V}(I) = \mathbf{V}(\tilde{I})$ . Also check that  $\mathbf{V}(I_1) = \mathbf{V}(\tilde{I}_1)$ .
- d. Follow the procedure described in the text for producing a new basis for  $\tilde{I}$ . Using this new basis, show that  $\tilde{W} \neq \mathbf{V}(I_1)$ .



4. Let  $f_i, g_i, h_i \in k[x_1, \dots, x_n]$  for  $1 \leq i \leq s$ . If we set  $\tilde{f}_i = f_i + h_i g_i$ , then prove that

$$\langle f_1, \dots, f_s, g_1, \dots, g_s \rangle = \langle \tilde{f}_1, \dots, \tilde{f}_s, g_1, \dots, g_s \rangle.$$

Then explain how the proof of Theorem 3 used a special case of this result.

5. To see how the Closure Theorem can fail over  $\mathbb{R}$ , consider the ideal

$$I = \langle x^2 + y^2 + z^2 + 2, 3x^2 + 4y^2 + 4z^2 + 5 \rangle.$$

Let  $V = \mathbf{V}(I)$ , and let  $\pi_1$  be the projection taking  $(x, y, z)$  to  $(y, z)$ .

- Working over  $\mathbb{C}$ , prove that  $\mathbf{V}(I_1) = \pi_1(V)$ .
- Working over  $\mathbb{R}$ , prove that  $V = \emptyset$  and that  $\mathbf{V}(I_1)$  is infinite. Thus,  $\mathbf{V}(I_1)$  may be much larger than the smallest variety containing  $\pi_1(V)$  when the field is not algebraically closed.

### §3 Implicitization

In Chapter 1, we saw that a variety  $V$  can sometimes be described using parametric equations. The basic idea of the *implicitization problem* is to convert the parametrization into defining equations for  $V$ . The name “implicitization” comes from Chapter 1, where the equations defining  $V$  were called an “implicit representation” of  $V$ . However, some care is required in giving a precise formulation of implicitization. The problem is that the parametrization need not fill up all of the variety  $V$ —an example is given by equation (4) from Chapter 1, §3. So the implicitization problem really asks for the equations defining the *smallest* variety  $V$  containing the parametrization. In this section, we will use the elimination theory developed in §§1 and 2 to give a complete solution of the implicitization problem.

Furthermore, once the smallest variety  $V$  has been found, two other interesting questions arise. First, does the parametrization fill up all of  $V$ ? Second, if there are missing points, how do we find them? As we will see, Groebner bases and the Extension Theorem give us powerful tools for studying this situation.

To illustrate these issues in a specific case, let us look at the tangent surface to the twisted cubic in  $\mathbb{R}^3$ , first studied in Chapter 1, §3. Recall that this surface is given parametrically by

$$(1) \quad \begin{aligned} x &= t + u, \\ y &= t^2 + 2tu, \\ z &= t^3 + 3t^2u. \end{aligned}$$

In §8 of Chapter 2, we used these equations to show that the tangent surface lies on the variety  $V$  in  $\mathbb{R}^3$  defined by

$$x^3z - (3/4)x^2y^2 - (3/2)xyz + y^3 + (1/4)z^2 = 0.$$

However, we do not know if  $V$  is the smallest variety containing the tangent surface and, thus, we cannot claim to have solved the implicitization problem. Furthermore, even if  $V$  is the smallest variety, we still do not know if the tangent surface fills it up completely. So there is a lot of work to do.

We begin our solution of the implicitization problem with the case of a *polynomial parametrization*, which is specified by the data

$$(2) \quad \begin{aligned} x_1 &= f_1(t_1, \dots, t_m), \\ &\vdots \\ x_n &= f_n(t_1, \dots, t_m). \end{aligned}$$

Here,  $f_1, \dots, f_n$  are polynomials in  $k[t_1, \dots, t_m]$ . We can think of this geometrically as the function

$$F : k^m \longrightarrow k^n$$

defined by

$$F(t_1, \dots, t_m) = (f_1(t_1, \dots, t_m), \dots, f_n(t_1, \dots, t_m)).$$

Then  $F(k^m) \subset k^n$  is the subset of  $k^n$  parametrized by equations (2). Since  $F(k^m)$  may not be an affine variety (examples will be given in the exercises), a solution of the implicitization problem means finding the smallest affine variety that contains  $F(k^m)$ .

We can relate implicitization to elimination as follows. Equations (2) define a variety  $V = \mathbf{V}(x_1 - f_1, \dots, x_n - f_n) \subset k^{n+m}$ . Points of  $V$  can be written in the form

$$(t_1, \dots, t_m, f_1(t_1, \dots, t_m), \dots, f_n(t_1, \dots, t_m)),$$

which shows that  $V$  can be regarded as the *graph* of the function  $F$ . We also have two other functions

$$\begin{aligned} i : k^m &\longrightarrow k^{n+m}, \\ \pi_m : k^{n+m} &\longrightarrow k^n \end{aligned}$$

defined by

$$\begin{aligned} i(t_1, \dots, t_m) &= (t_1, \dots, t_m, f_1(t_1, \dots, t_m), \dots, f_n(t_1, \dots, t_m)) \\ \pi_m(t_1, \dots, t_m, x_1, \dots, x_n) &= (x_1, \dots, x_n). \end{aligned}$$

This gives us the following diagram of sets and maps:

$$(3) \quad \begin{array}{ccc} & k^{n+m} & \\ & \nearrow i & \searrow \pi_m \\ k^m & \xrightarrow{F} & k^n \end{array}$$

Note that  $F$  is then the composition  $F = \pi_m \circ i$ . It is also straightforward to show that  $i(k^m) = V$ . Thus, we obtain

$$(4) \quad F(k^m) = \pi_m(i(k^m)) = \pi_m(V).$$

In more concrete terms, this says that the image of the parametrization is the projection of its graph. We can now use elimination theory to find the smallest variety containing  $F(k^m)$ .

**Theorem 1 (Polynomial Implicitization).** *If  $k$  is an infinite field, let  $F : k^m \rightarrow k^n$  be the function determined by the polynomial parametrization (2). Let  $I$  be the ideal  $I = \langle x_1 - f_1, \dots, x_n - f_n \rangle \subset k[t_1, \dots, t_m, x_1, \dots, x_n]$  and let  $I_m = I \cap k[x_1, \dots, x_n]$  be the  $m$ -th elimination ideal. Then  $\mathbf{V}(I_m)$  is the smallest variety in  $k^n$  containing  $F(k^m)$ .*

**Proof.** Let  $V = \mathbf{V}(I) \subset k^{n+m}$ . The above discussion shows that  $V$  is the graph of  $F : k^m \rightarrow k^n$ . Now assume that  $k = \mathbb{C}$ . By (4), we have  $F(\mathbb{C}^m) = \pi_m(V)$ , and by the Closure Theorem from §2, we know that  $\mathbf{V}(I_m)$  is the smallest variety containing  $\pi_m(V)$ . This proves the theorem when  $k = \mathbb{C}$ .

Next, suppose that  $k$  is a subfield of  $\mathbb{C}$ . This means that  $k \subset \mathbb{C}$  and that  $k$  inherits its field operations from  $\mathbb{C}$ . Such a field always contains the integers  $\mathbb{Z}$  (in fact, it contains  $\mathbb{Q}$ —do you see why?) and, thus, is infinite. Since  $k$  may be strictly smaller than  $\mathbb{C}$ , we cannot use the Closure Theorem directly. Our strategy will be to switch back and forth between  $k$  and  $\mathbb{C}$ , and we will use the subscript  $k$  or  $\mathbb{C}$  to keep track of which field we are working with. Thus,  $\mathbf{V}_k(I_m)$  is the variety we get in  $k^n$ , whereas  $\mathbf{V}_{\mathbb{C}}(I_m)$  is the larger set of solutions in  $\mathbb{C}^n$ . (Note that going to the larger field does not change the elimination ideal  $I_m$ . This is because the algorithm used to compute the elimination ideal is unaffected by changing from  $k$  to  $\mathbb{C}$ .) We need to prove that  $\mathbf{V}_k(I_m)$  is the smallest variety in  $k^n$  containing  $F(k^m)$ .

By equation (4) of this section and Lemma 1 of §2, we know that  $F(k^m) = \pi_m(V_k) \subset \mathbf{V}_k(I_m)$ . Now let  $Z_k = \mathbf{V}_k(g_1, \dots, g_s) \subset k^n$  be any variety of  $k^n$  such that  $F(k^m) \subset Z_k$ . We must show  $\mathbf{V}_k(I_m) \subset Z_k$ . We begin by noting that  $g_i = 0$  on  $Z_k$  and, hence,  $g_i = 0$  on the smaller set  $F(k^m)$ . This shows that each  $g_i \circ F$  vanishes on all of  $k^m$ . But  $g_i$  is a polynomial in  $k[x_1, \dots, x_n]$ , and  $F = (f_1, \dots, f_n)$  is made up of polynomials in  $k[t_1, \dots, t_m]$ . It follows that  $g_i \circ F \in k[t_1, \dots, t_m]$ .

Thus, the  $g_i \circ F$ 's are polynomials that vanish on  $k^m$ . Since  $k$  is infinite, Proposition 5 of Chapter 1, §1 implies that each  $g_i \circ F$  is the zero polynomial. In particular, this means that  $g_i \circ F$  also vanishes on  $\mathbb{C}^m$ , and thus the  $g_i$ 's vanish on  $F(\mathbb{C}^m)$ . Hence,  $Z_{\mathbb{C}} = \mathbf{V}_{\mathbb{C}}(g_1, \dots, g_s)$  is a variety of  $\mathbb{C}^n$  containing  $F(\mathbb{C}^m)$ . Since the theorem is true for  $\mathbb{C}$ , it follows that  $\mathbf{V}_{\mathbb{C}}(I_m) \subset Z_{\mathbb{C}}$  in  $\mathbb{C}^n$ . If we then look at the solutions that lie in  $k^n$ , it follows immediately that  $\mathbf{V}_k(I_m) \subset Z_k$ . This proves that  $\mathbf{V}_k(I_m)$  is the smallest variety of  $k^n$  containing  $F(k^m)$ .

Finally, if  $k$  is a field not contained in  $\mathbb{C}$ , one can prove that there is an algebraically closed field  $K$  such that  $k \subset K$  [see Chapter VII, §2 of LANG (1965)]. As we remarked at the end of §2, the Closure Theorem holds over any algebraically closed field. Then the theorem follows using the above argument with  $\mathbb{C}$  replaced by  $K$ .  $\square$

Theorem 1 gives the following **implicitization algorithm for polynomial parametrizations**: if we have  $x_i = f_i(t_1, \dots, t_m)$  for polynomials  $f_1, \dots, f_n \in k[t_1, \dots, t_m]$ , consider the ideal  $I = \langle x_1 - f_1, \dots, x_n - f_n \rangle$  and compute a Groebner basis with respect to a lexicographic ordering where every  $t_i$  is greater than every  $x_i$ . By the Elimination Theorem, the elements of the Groebner basis not involving  $t_1, \dots, t_m$  form a basis of  $I_m$ , and by Theorem 1, they define the smallest variety in  $k^n$  containing the parametrization.

For an example of how this algorithm works, let us look at the tangent surface to the twisted cubic in  $\mathbb{R}^3$ , which is given by the polynomial parametrization (1). Thus, we need to consider the ideal

$$I = \langle x - t - u, y - t^2 - 2tu, z - t^3 - 3t^2u \rangle \subset \mathbb{R}[t, u, x, y, z].$$

Using lex order with  $t > u > x > y > z$ , a Groebner basis for  $I$  is given by

$$\begin{aligned} g_1 &= t + u - x, \\ g_2 &= u^2 - x^2 + y, \\ g_3 &= ux^2 - uy - x^3 + (3/2)xy - (1/2)z, \\ g_4 &= uxy - uz - x^2y - xz + 2y^2, \\ g_5 &= uxz - uy^2 + x^2z - (1/2)xy^2 - (1/2)yz, \\ g_6 &= uy^3 - uz^2 - 2x^2yz + (1/2)xy^3 - xz^2 + (5/2)y^2z, \\ g_7 &= x^3z - (3/4)x^2y^2 - (3/2)xyz + y^3 + (1/4)z^2. \end{aligned}$$

The Elimination Theorem tells us that  $I_2 = I \cap \mathbb{R}[x, y, z] = \langle g_7 \rangle$ , and thus by Theorem 1,  $\mathbf{V}(g_7)$  solves the implicitization problem for the tangent surface of the twisted cubic. The equation  $g_7 = 0$  is exactly the one given at the start of this section, but now we know it defines the smallest variety in  $\mathbb{R}^3$  containing the tangent surface.

But we still do not know if the tangent surface fills up *all* of  $\mathbf{V}(g_7) \subset \mathbb{R}^3$ . To answer this question, we must see whether all partial solutions  $(x, y, z) \in \mathbf{V}(g_7) = \mathbf{V}(I_2)$  extend to  $(t, u, x, y, z) \in \mathbf{V}(I)$ . We will first work over  $\mathbb{C}$  so that we can use the Extension Theorem. As usual, our strategy will be to add one coordinate at a time.

Let us start with  $(x, y, z) \in \mathbf{V}(I_2) = \mathbf{V}(g_7)$ . In §1, we observed that  $I_2$  is the first elimination ideal of  $I_1$ . Further, the Elimination Theorem tells us that  $I_1 = \langle g_2, \dots, g_7 \rangle$ . Then the Extension Theorem, in the form of Corollary 4 of §1, implies that  $(x, y, z)$  always extends to  $(u, x, y, z) \in \mathbf{V}(I_1)$  since  $I_1$  has a generator with a constant leading coefficient of  $u$  (we leave it to you to find which of  $g_2, \dots, g_7$  has this property). Going from  $(u, x, y, z) \in \mathbf{V}(I_1)$  to  $(t, u, x, y, z) \in \mathbf{V}(I)$  is just as easy: using Corollary 4 of §1 again, we can always extend since  $g_1 = t + u - x$  has a constant leading coefficient of  $t$ . We have thus proved that the tangent surface to the twisted cubic equals  $\mathbf{V}(g_7)$  in  $\mathbb{C}^3$ .

It remains to see what happens over  $\mathbb{R}$ . If we start with a real solution  $(x, y, z) \in \mathbb{R}^3$  of  $g_7 = 0$ , we know that it extends to  $(t, u, x, y, z) \in \mathbf{V}(I) \subset \mathbb{C}^5$ . But are the parameters  $t$  and  $u$  real? This is not immediately obvious. However, if you look at the above Groebner basis, you can check that  $t$  and  $u$  are real when  $(x, y, z) \in \mathbb{R}^3$  (see Exercise 4). It follows that the tangent surface to the twisted cubic in  $\mathbb{R}^3$  equals the variety defined by

$$x^3z - (3/4)x^2y^2 - (3/2)xyz + y^3 + (1/4)z^2 = 0.$$

In general, the question of whether a parametrization fills up all of its variety can be difficult to answer. Each case has to be analyzed separately. But as indicated by the example just completed, the combination of Groebner bases and the Extension Theorem can shed considerable light on what is going on.

In our discussion of implicitization, we have thus far only considered polynomial parametrizations. The next step is to see what happens when we have a parametrization by rational functions. To illustrate the difficulties that can arise, consider the following rational parametrization:

$$(5) \quad \begin{aligned} x &= \frac{u^2}{v}, \\ y &= \frac{v^2}{u}, \\ z &= u. \end{aligned}$$

It is easy to check that the point  $(x, y, z)$  always lies on the surface  $x^2y = z^3$ . Let us see what happens if we clear denominators in the above equations and apply the polynomial implicitization algorithm. We get the ideal

$$I = \langle vx - u^2, uy - v^2, z - u \rangle \subset k[u, v, x, y, z],$$

and we leave it as an exercise to show that  $I_2 = I \cap k[x, y, z]$  is given by  $I_2 = \langle z(x^2y - z^3) \rangle$ . This implies that

$$\mathbf{V}(I_2) = \mathbf{V}(x^2y - z^3) \cup \mathbf{V}(z),$$

and, in particular,  $\mathbf{V}(I_2)$  is *not* the smallest variety containing the parametrization. So the above ideal  $I$  is not what we want—simply “clearing denominators” is too naive. To find an ideal that works better, we will need to be more clever.

In the general situation of a rational parametrization, we have

$$(6) \quad \begin{aligned} x_1 &= \frac{f_1(t_1, \dots, t_m)}{g_1(t_1, \dots, t_m)}, \\ &\vdots \\ x_n &= \frac{f_n(t_1, \dots, t_m)}{g_n(t_1, \dots, t_m)}, \end{aligned}$$

where  $f_1, g_1, \dots, f_n, g_n$  are polynomials in  $k[t_1, \dots, t_m]$ . The map  $F$  from  $k^m$  to  $k^n$  given by (6) may not be defined on all of  $k^m$  because of the denominators. But if we let  $W = \mathbf{V}(g_1g_2 \cdots g_n) \subset k^m$ , then it is clear that

$$F(t_1, \dots, t_m) = \left( \frac{f_1(t_1, \dots, t_m)}{g_1(t_1, \dots, t_m)}, \dots, \frac{f_n(t_1, \dots, t_m)}{g_n(t_1, \dots, t_m)} \right)$$

defines a map

$$F : k^m - W \longrightarrow k^n.$$

To solve the implicitization problem, we need to find the smallest variety of  $k^n$  containing  $F(k^m - W)$ .

We can adapt diagram (3) to this case by writing

$$(7) \quad \begin{array}{ccc} & & k^{n+m} \\ & \nearrow i & \searrow \pi_m \\ k^m - W & \xrightarrow{F} & k^n \end{array}$$

It is easy to check that  $i(k^m - W) \subset \mathbf{V}(I)$ , where  $I = \langle g_1x_1 - f_1, \dots, g_nx_n - f_n \rangle$  is the ideal obtained by “clearing denominators.” The problem is that  $\mathbf{V}(I)$  may *not* be the smallest variety containing  $i(k^m - W)$ . In the exercises, you will see that (5) is such an example.

To avoid this difficulty, we will alter the ideal  $I$  slightly by using an extra dimension to control the denominators. Consider the polynomial ring  $k[y, t_1, \dots, t_m, x_1, \dots, x_n]$  which gives us the affine space  $k^{n+m+1}$ . Let  $g$  be the product  $g = g_1 \cdot g_2 \cdot \dots \cdot g_n$ , so that  $W = \mathbf{V}(g)$ . Then consider the ideal

$$J = \langle g_1x_1 - f_1, \dots, g_nx_n - f_n, 1 - gy \rangle \subset k[y, t_1, \dots, t_m, x_1, \dots, x_n].$$

Note that the equation  $1 - gy = 0$  means that the denominators  $g_1, \dots, g_n$  never vanish on  $\mathbf{V}(J)$ . To adapt diagram (7) to this new situation, consider the maps

$$\begin{aligned} j : k^m - W &\longrightarrow k^{n+m+1}, \\ \pi_{m+1} : k^{n+m+1} &\longrightarrow k^n \end{aligned}$$

defined by

$$\begin{aligned} j(t_1, \dots, t_m) &= \left( \frac{1}{g(t_1, \dots, t_m)}, t_1, \dots, t_m, \frac{f_1(t_1, \dots, t_m)}{g_1(t_1, \dots, t_m)}, \dots, \frac{f_n(t_1, \dots, t_m)}{g_n(t_1, \dots, t_m)} \right), \\ \pi_{m+1}(y, t_1, \dots, t_m, x_1, \dots, x_n) &= (x_1, \dots, x_n), \end{aligned}$$

respectively. Then we get the diagram

$$\begin{array}{ccc} & & k^{n+m+1} \\ & \nearrow j & \searrow \pi_{m+1} \\ k^m - W & \xrightarrow{F} & k^n \end{array}$$

As before, we have  $F = \pi_{m+1} \circ j$ . The surprise is that  $j(k^m - W) = \mathbf{V}(J)$  in  $k^{n+m+1}$ . To see this, note that  $j(k^m - W) \subset \mathbf{V}(J)$  follows easily from the definitions of  $j$  and  $J$ . Going the other way, if  $(y, t_1, \dots, t_m, x_1, \dots, x_n) \in \mathbf{V}(J)$ , then  $g(t_1, \dots, t_m)y = 1$  implies that *none* of the  $g_i$ 's vanish at  $(t_1, \dots, t_m)$  and, thus,  $g_i(t_1, \dots, t_m)x_i = f_i(t_1, \dots, t_m)$  can be solved for  $x_i = f_i(t_1, \dots, t_m)/g_i(t_1, \dots, t_m)$ . Since  $y = 1/g(t_1, \dots, t_m)$ , it follows that our point lies in  $j(k^m - W)$ . This proves  $\mathbf{V}(J) \subset j(k^m - W)$ .

From  $F = \pi_{m+1} \circ j$  and  $j(k^m - W) = \mathbf{V}(J)$ , we obtain

$$(8) \quad F(k^m - W) = \pi_{m+1}(j(k^m - W)) = \pi_{m+1}(\mathbf{V}(J)).$$

Thus, the image of the parametrization is the projection of the variety  $\mathbf{V}(J)$ . As with

the polynomial case, we can now use elimination theory to solve the implicitization problem.

**Theorem 2 (Rational Implicitization).** *If  $k$  is an infinite field, let  $F : k^m - W \rightarrow k^n$  be the function determined by the rational parametrization (6). Let  $J$  be the ideal  $J = \langle g_1x_1 - f_1, \dots, g_nx_n - f_n, 1 - gy \rangle \subset k[y, t_1, \dots, t_m, x_1, \dots, x_n]$ , where  $g = g_1 \cdot g_2 \cdots g_n$ , and let  $J_{m+1} = J \cap k[x_1, \dots, x_n]$  be the  $(m + 1)$ -th elimination ideal. Then  $\mathbf{V}(J_{m+1})$  is the smallest variety in  $k^n$  containing  $F(k^m - W)$ .*

**Proof.** The proof is similar to the proof of Theorem 1. One uses equation (8) rather than equation (4). The only tricky point is showing that a polynomial vanishing on  $k^m - W$  must be the zero polynomial. The exercises at the end of the section will take you through the details.  $\square$

The interpretation of Theorem 2 is very nice: given the rational parametrization (6), consider the equations

$$\begin{aligned} g_1x_1 &= f_1, \\ &\vdots \\ g_nx_n &= f_n, \\ g_1g_2 \cdots g_ny &= 1. \end{aligned}$$

These equations are obtained from (6) by “clearing denominators” and adding a final equation (in the new variable  $y$ ) to prevent the denominators from vanishing. Then eliminating  $y, t_1, \dots, t_m$  gives us the equations we want.

More formally, Theorem 2 implies the following **implicitization algorithm for rational parametrizations**: if we have  $x_i = f_i/g_i$  for polynomials  $f_1, g_1, \dots, f_n, g_n \in k[t_1, \dots, t_m]$ , consider the new variable  $y$  and  $J = \langle g_1x_1 - f_1, \dots, g_nx_n - f_n, 1 - gy \rangle$ , where  $g = g_1 \cdots g_n$ . Compute a Groebner basis with respect to a lexicographic ordering where  $y$  and every  $t_i$  are greater than every  $x_i$ . Then the elements of the Groebner basis not involving  $y, t_1, \dots, t_m$  define the smallest variety in  $k^n$  containing the parametrization.

Let us see how this algorithm works for example (5). Let  $w$  be the new variable, so that

$$J = \langle vx - u^2, uy - v^2, z - u, 1 - uvw \rangle \subset k[w, u, v, x, y, z].$$

One easily calculates that  $J_3 = J \cap k[x, y, z] = \langle x^2y - z^3 \rangle$ , so that  $\mathbf{V}(x^2y - z^3)$  is the variety determined by the parametrization (5). In the exercises, you will study how much of  $\mathbf{V}(x^2y - z^3)$  is filled up by the parametrization.

We should also mention that in practice, resultants are often used to solve the implicitization problem. Implicitization for curves and surfaces is discussed in ANDERSON, GOLDMAN and SEDERBERG (1984a) and (1984b). Another reference is CANNY and MANOCHA (1992), which shows how implicitization of parametric surfaces can be done using multipolynomial resultants.

## EXERCISES FOR §3

1. In diagram (3) in the text, prove carefully that  $F = \pi_m \circ i$  and  $i(k^m) = V$ .
2. When  $k = \mathbb{C}$ , the conclusion of Theorem 1 can be strengthened. Namely, one can show that there is a variety  $W \subsetneq V(I_m)$  such that  $V(I_m) - W \subset F(\mathbb{C}^m)$ . Prove this using the Closure Theorem.
3. Give an example to show that Exercise 2 is false over  $\mathbb{R}$ . Hint:  $t^2$  is always positive.
4. In the text, we proved that over  $\mathbb{C}$ , the tangent surface to the twisted cubic is defined by the equation

$$g_7 = x^3z - (3/4)x^2y^2 - (3/2)xyz + y^3 + (1/4)z^2 = 0.$$

We want to show that the same is true over  $\mathbb{R}$ . If  $(x, y, z)$  is a real solution of the above equation, then we proved (using the Extension Theorem) that there are  $t, u \in \mathbb{C}$  such that

$$\begin{aligned}x &= t + u, \\y &= t^2 + 2tu, \\z &= t^3 + 3t^2u.\end{aligned}$$

Use the Groebner basis given in the text to show that  $t$  and  $u$  are real. This will prove that  $(x, y, z)$  is on the tangent surface in  $\mathbb{R}^3$ . Hint: First show that  $u$  is real.

5. In the parametrization of the tangent surface of the twisted cubic, show that the parameters  $t$  and  $u$  are uniquely determined by  $x, y$ , and  $z$ . Hint: The argument is similar to what you did in Exercise 4.
6. Let  $S$  be the parametric surface defined by

$$\begin{aligned}x &= uv, \\y &= u^2, \\z &= v^2.\end{aligned}$$

- a. Find the equation of the smallest variety  $V$  that contains  $S$ .
  - b. Over  $\mathbb{C}$ , use the Extension Theorem to prove that  $S = V$ . Hint: The argument is similar to what we did for the tangent surface of the twisted cubic.
  - c. Over  $\mathbb{R}$ , show that  $S$  only covers “half” of  $V$ . What parametrization would cover the other “half”?
7. Let  $S$  be the parametric surface

$$\begin{aligned}x &= uv, \\y &= uv^2, \\z &= u^2.\end{aligned}$$

- a. Find the equation of the smallest variety  $V$  that contains  $S$ .
  - b. Over  $\mathbb{C}$ , show that  $V$  contains points which are not on  $S$ . Determine exactly which points of  $V$  are not on  $S$ . Hint: Use lexicographic order with  $u > v > x > y > z$ .
8. The *Enneper surface* is defined parametrically by

$$\begin{aligned}x &= 3u + 3uv^2 - u^3, \\y &= 3v + 3u^2v - v^3, \\z &= 3u^2 - 3v^2.\end{aligned}$$



- a. Find the equation of the smallest variety  $V$  containing the Enneper surface. It will be a very complicated equation!
- b. Over  $\mathbb{C}$ , use the Extension Theorem to prove that the above equations parametrize the entire surface  $V$ . Hint: There are a lot of polynomials in the Groebner basis. Keep looking—you will find what you need.
9. The *Whitney umbrella surface* is given parametrically by

$$\begin{aligned}x &= uv, \\y &= v, \\z &= u^2.\end{aligned}$$

A picture of this surface is:

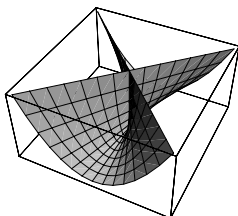

- a. Find the equation of the smallest variety containing the Whitney umbrella.
- b. Show that the parametrization fills up the variety over  $\mathbb{C}$  but not over  $\mathbb{R}$ . Over  $\mathbb{R}$ , exactly what points are omitted?
- c. Show that the parameters  $u$  and  $v$  are not always uniquely determined by  $x$ ,  $y$ , and  $z$ . Find the points where uniqueness fails and explain how your answer relates to the picture.
10. Consider the curve in  $\mathbb{C}^n$  parametrized by  $x_i = f_i(t)$ , where  $f_1, \dots, f_n$  are polynomials in  $\mathbb{C}[t]$ . This gives the ideal

$$I = \langle x_1 - f_1(t), \dots, x_n - f_n(t) \rangle \subset \mathbb{C}[t, x_1, \dots, x_n].$$

- a. Prove that the parametric equations fill up all of the variety  $\mathbf{V}(I_1) \subset \mathbb{C}^n$ .
- b. Show that the conclusion of part (a) may fail if we let  $f_1, \dots, f_n$  be rational functions. Hint: See §3 of Chapter 1.
- c. Even if all of the  $f_i$ 's are polynomials, show that the conclusion of part (a) may fail if we work over  $\mathbb{R}$ .
11. This problem is concerned with the proof of Theorem 2.
- a. Let  $k$  be an infinite field and let  $f, g \in k[t_1, \dots, t_m]$ . Assume that  $g \neq 0$  and that  $f$  vanishes on  $k^m - \mathbf{V}(g)$ . Prove that  $f$  is the zero polynomial. Hint: Consider the product  $fg$ .
- b. Prove Theorem 2 using the hints given in the text.
12. Consider the parametrization (5) given in the text. For simplicity, let  $k = \mathbb{C}$ . Also let  $I = \langle vx - u^2, uy - v^2, z - u, x^2y - z^3 \rangle$  be the ideal obtained by “clearing denominators.”
- a. Show that  $I_2 = \langle z(x^2y - z^3) \rangle$ .
- b. Show that the smallest variety in  $\mathbb{C}^5$  containing  $i(\mathbb{C}^2 - W)$  [see diagram (7)] is  $\mathbf{V}(vx - u^2, uy - v^2, z - u, x^2y - z^3, vz - xy)$ . Hint: Show that  $i(\mathbb{C}^2 - W) = \pi_1(\mathbf{V}(J))$ , and then use the Closure Theorem.

- c. Show that  $\{(0, 0, x, y, 0) : x, y \text{ arbitrary}\} \subset \mathbf{V}(I)$  and conclude that  $\mathbf{V}(I)$  is *not* the smallest variety containing  $i(\mathbb{C}^2 - W)$ .
- d. Determine exactly which portion of  $x^2y = z^3$  is parametrized by (5).
13. Given a rational parametrization as in (6), there is one case where the naive ideal  $I = \langle g_1x_1 - f_1, \dots, g_nx_n - f_n \rangle$  obtained by “clearing denominators” gives the right answer. Suppose that  $x_i = f_i(t)/g_i(t)$  where there is only one parameter  $t$ . We can assume that for each  $i$ ,  $f_i(t)$  and  $g_i(t)$  are relatively prime in  $k[t]$  (so in particular, they have no common roots). If  $I \subset k[t, x_1, \dots, x_n]$  is as above, then prove that  $\mathbf{V}(I_1)$  is the smallest variety containing  $F(k - W)$ , where as usual  $g = g_1 \cdots g_n \in k[t]$  and  $W = \mathbf{V}(g) \subset k$ . Hint: In diagram (7), show that  $i(k^m - W) = \mathbf{V}(I)$ , and adapt the proof of Theorem 1.
14. The *folium of Descartes* can be parametrized by

$$x = \frac{3t}{1+t^3},$$

$$y = \frac{3t^2}{1+t^3}.$$

- a. Find the equation of the folium. Hint: Use Exercise 13.
- b. Over  $\mathbb{C}$  or  $\mathbb{R}$ , show that the above parametrization covers the entire curve.
15. In Exercise 16 to §3 of Chapter 1, we studied the parametric equations over  $\mathbb{R}$

$$x = \frac{(1-t)^2x_1 + 2t(1-t)wx_2 + t^2x_3}{(1-t)^2 + 2t(1-t)w + t^2},$$

$$y = \frac{(1-t)^2y_1 + 2t(1-t)wy_2 + t^2y_3}{(1-t)^2 + 2t(1-t)w + t^2},$$

where  $w, x_1, y_1, x_2, y_2, x_3, y_3$  are constants and  $w > 0$ . By eliminating  $t$ , show that these equations describe a portion of a conic section. Recall that a conic section is described by an equation of the form

$$ax^2 + bxy + cy^2 + dx + ey + f = 0.$$

Hint: In most computer algebra systems, the Groebner basis command allows polynomials to have coefficients involving symbolic constants like  $w, x_1, y_1, x_2, y_2, x_3, y_3$ .

## §4 Singular Points and Envelopes

In this section, we will discuss two topics from geometry:

- the *singular points* on a curve,
- the *envelope* of a family of curves.

Our goal is to show how geometry provides interesting equations that can be solved by the techniques studied in §§1 and 2.

We will introduce some of the basic ideas concerning singular points and envelopes, but our treatment will be far from complete. One could write an entire book on these topics [see, for example, BRUCE and GIBLIN (1992)]. Also, our discussion of envelopes

will not be fully rigorous. We will rely on some ideas from calculus to justify what is going on.

### *Singular Points*

Suppose that we have a curve in the plane  $k^2$  defined by  $f(x, y) = 0$ , where  $f \in k[x, y]$ . We expect that  $\mathbf{V}(f)$  will have a well-defined tangent line at most points, although this may fail where the curve crosses itself or has a kink. Here are two examples:

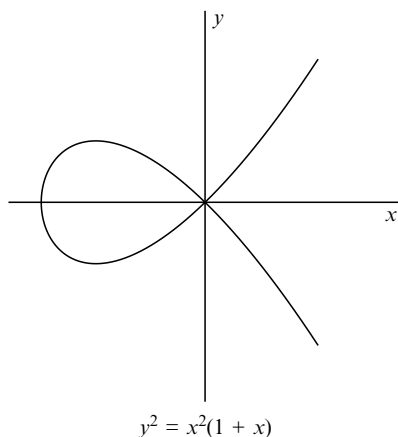
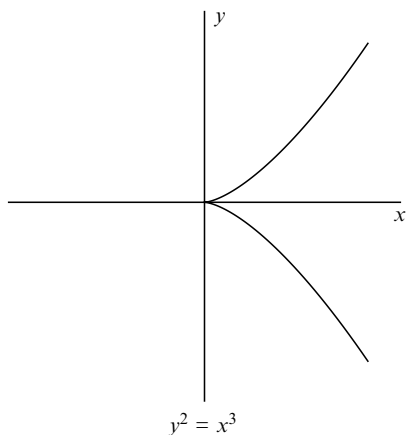

If we demand that a tangent line be unique and follow the curve on both sides of the point, then each of these curves has a point where there is no tangent. Intuitively, a *singular point* of  $\mathbf{V}(f)$  is a point such as above where the tangent line fails to exist.

To make this notion more precise, we first must give an algebraic definition of tangent line. We will use the following approach. Given a point  $(a, b) \in \mathbf{V}(f)$ , a line  $L$  through  $(a, b)$  is given parametrically by

$$(1) \quad \begin{aligned} x &= a + ct, \\ y &= b + dt. \end{aligned}$$

This line goes through  $(a, b)$  when  $t = 0$ . Notice also that  $(c, d) \neq (0, 0)$  is a vector parallel to the line. Thus, by varying  $(c, d)$ , we get all lines through  $(a, b)$ . But how do we find the one that is *tangent* to  $\mathbf{V}(f)$ ? Can we find it without using calculus?

Let us look at an example. Consider the line  $L$

$$(2) \quad \begin{aligned} x &= 1 + ct, \\ y &= 1 + dt, \end{aligned}$$

through the point  $(1, 1)$  on the parabola  $y = x^2$ :

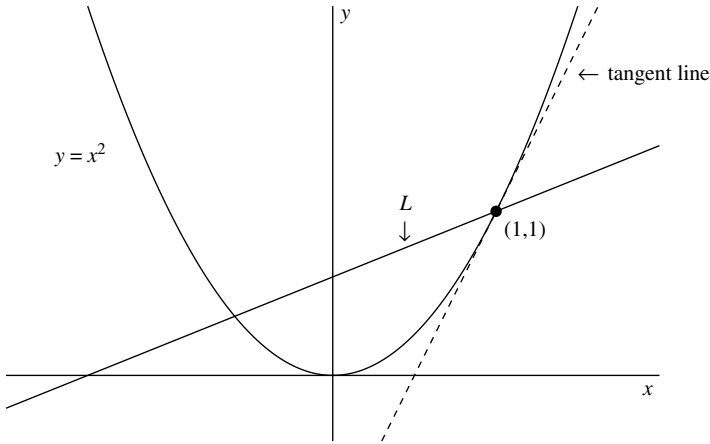

From calculus, we know that the tangent line has slope 2, which corresponds to the line with  $d = 2c$  in the above parametrization. To find this line by algebraic means, we will study the *polynomial* that describes how the line meets the parabola. If we substitute (2) into the left-hand side of  $y - x^2 = 0$ , we get the polynomial

$$(3) \quad g(t) = 1 + dt - (1 + ct)^2 = -c^2t^2 + (d - 2c)t = t(-c^2t + d - 2c).$$

The roots of  $g$  determine where the line intersects the parabola (be sure you understand this). If  $d \neq 2c$ , then  $g$  has two distinct roots when  $c \neq 0$  and one root when  $c = 0$ . But if  $d = 2c$ , then  $g$  has a root of multiplicity 2. Thus, we can detect when the line (2) is tangent to the parabola by looking for a *multiple root*.

Based on this example, let us make the following definition.

**Definition 1.** Let  $k$  be a positive integer. Suppose that we have a point  $(a, b) \in \mathbf{V}(f)$  and let  $L$  be the line through  $(a, b)$ . Then  $L$  **meets  $\mathbf{V}(f)$  with multiplicity  $k$  at  $(a, b)$**  if  $L$  can be parametrized as in (1) so that  $t = 0$  is a root of multiplicity  $k$  of the polynomial  $g(t) = f(a + ct, b + dt)$ .

In this definition, note that  $g(0) = f(a, b) = 0$ , so that  $t = 0$  is a root of  $g$ . Also, recall that  $t = 0$  is a root of multiplicity  $k$  when  $g = t^k h$ , where  $h(0) \neq 0$ . One ambiguity with this definition is that a given line has many different parametrizations. So we need to check that the notion of multiplicity is independent of the parametrization. This will be covered in the exercises.

For an example of how this definition works, consider the line given by (2) above. It should be clear from (3) that the line meets the parabola  $y = x^2$  with multiplicity 1

at  $(1, 1)$  when  $d \neq 2c$  and with multiplicity 2 when  $d = 2c$ . Other examples will be given in the exercises.

We will use the notion of multiplicity to pick out the tangent line. To make this work, we will need the *gradient vector* of  $f$ , which is defined to be

$$\nabla f = \left( \frac{\partial}{\partial x} f, \frac{\partial}{\partial y} f \right).$$

We can now state our result.

**Proposition 2.** *Let  $f \in k[x, y]$ , and let  $(a, b) \in \mathbf{V}(f)$ .*

- (i) *If  $\nabla f(a, b) \neq (0, 0)$ , then there is a unique line through  $(a, b)$  which meets  $\mathbf{V}(f)$  with multiplicity  $\geq 2$ .*
- (ii) *If  $\nabla f(a, b) = (0, 0)$ , then every line through  $(a, b)$  meets  $\mathbf{V}(f)$  with multiplicity  $\geq 2$ .*

**Proof.** Let a line  $L$  through  $(a, b)$  be parametrized as in equation (1) and let  $g(t) = f(a + ct, b + dt)$ . Since  $(a, b) \in \mathbf{V}(f)$ , it follows that  $t = 0$  is a root of  $g$ . The following observation will be proved in the exercises:

$$(4) \quad t = 0 \text{ is a root of } g \text{ of multiplicity } \geq 2 \Leftrightarrow g'(0) = 0.$$

Using the chain rule, one sees that

$$g'(t) = \frac{\partial}{\partial x} f(a + ct, b + dt) \cdot c + \frac{\partial}{\partial y} f(a + ct, b + dt) \cdot d.$$

and thus

$$g'(0) = \frac{\partial}{\partial x} f(a, b) \cdot c + \frac{\partial}{\partial y} f(a, b) \cdot d.$$

If  $\nabla f(a, b) = (0, 0)$ , then the above equation shows that  $g'(0)$  always equals 0. By (4), it follows that  $L$  always meets  $\mathbf{V}(f)$  at  $(a, b)$  with multiplicity  $\geq 2$ . This proves the second part of the proposition. Turning to the first part, suppose that  $\nabla f(a, b) \neq (0, 0)$ . We know that  $g'(0) = 0$  if and only if

$$(5) \quad \frac{\partial}{\partial x} f(a, b) \cdot c + \frac{\partial}{\partial y} f(a, b) \cdot d = 0.$$

This is a linear equation in the unknowns  $c$  and  $d$ . Since the coefficients  $\frac{\partial}{\partial x} f(a, b)$  and  $\frac{\partial}{\partial y} f(a, b)$  are not both zero, the solution space is 1-dimensional. Thus, there is  $(c_0, d_0) \neq (0, 0)$  such that  $(c, d)$  satisfies the above equation if and only if  $(c, d) = \lambda(c_0, d_0)$  for some  $\lambda \in k$ . It follows that the  $(c, d)$ 's giving  $g'(0) = 0$  all parametrize the same line  $L$ . This shows that there is a unique line which meets  $\mathbf{V}(f)$  at  $(a, b)$  with multiplicity  $\geq 2$ . Proposition 2 is proved.  $\square$

Using Proposition 2, it is now obvious how to define the tangent line. From the second part of the proposition, it is also clear what a singular point should be.

**Definition 3.** Let  $f \in k[x, y]$  and let  $(a, b) \in \mathbf{V}(f)$ .

- (i) If  $\nabla f(a, b) \neq (0, 0)$ , then the **tangent line** of  $\mathbf{V}(f)$  at  $(a, b)$  is the unique line through  $(a, b)$  which meets  $\mathbf{V}(f)$  with multiplicity  $\geq 2$ . We say that  $(a, b)$  is a **nonsingular point** of  $\mathbf{V}(f)$ .
- (ii) If  $\nabla f(a, b) = (0, 0)$ , then we say that  $(a, b)$  is a **singular point** of  $\mathbf{V}(f)$ .

Over  $\mathbb{R}$ , the tangent line and the gradient have the following geometric interpretation. If the tangent to  $\mathbf{V}(f)$  at  $(a, b)$  is parametrized by (1), then the vector  $(c, d)$  is parallel to the tangent line. But we also know from equation (5) that the dot product  $\nabla f(a, b) \cdot (c, d)$  is zero, which means that  $\nabla f(a, b)$  is perpendicular to  $(c, d)$ . Thus, we have an algebraic proof of the theorem from calculus that *the gradient  $\nabla f(a, b)$  is perpendicular to the tangent line of  $\mathbf{V}(f)$  at  $(a, b)$ .*

For any given curve  $\mathbf{V}(f)$ , we can compute the singular points as follows. The gradient  $\nabla f$  is zero when  $\frac{\partial}{\partial x} f$  and  $\frac{\partial}{\partial y} f$  vanish simultaneously. Since we also have to be on  $\mathbf{V}(f)$ , we need  $f = 0$ . It follows that the singular points of  $\mathbf{V}(f)$  are determined by the equations

$$f = \frac{\partial}{\partial x} f = \frac{\partial}{\partial y} f = 0.$$

As an example, consider the curve  $y^2 = x^2(1 + x)$  shown earlier. To find the singular points, we must solve

$$\begin{aligned} f &= y^2 - x^2 - x^3 = 0, \\ \frac{\partial}{\partial x} f &= -2x - 3x^2 = 0, \\ \frac{\partial}{\partial y} f &= 2y = 0. \end{aligned}$$

From these equations, it is easy to see that  $(0, 0)$  is the only singular point of  $\mathbf{V}(f)$ . This agrees with the earlier picture.

Using the methods learned in §§1 and 2, we can tackle much more complicated problems. For example, later in this section we will determine the singular points of the curve defined by the sixth degree equation

$$\begin{aligned} 0 &= -1156 + 688x^2 - 191x^4 + 16x^6 + 544y + 30x^2y - 40x^4y \\ &\quad + 225y^2 - 96x^2y^2 + 16x^4y^2 - 136y^3 - 32x^2y^3 + 16y^4. \end{aligned}$$

The exercises will explore some other aspects of singular points. In Chapter 9, we will study singular and nonsingular points on an arbitrary affine variety.

## Envelopes

In our discussion of envelopes, we will work over  $\mathbb{R}$  to make the geometry easier to see. The best way to explain what we mean by envelope is to compute an example. Let  $t \in \mathbb{R}$ , and consider the circle in  $\mathbb{R}^2$  defined by the equation

$$(6) \quad (x - t)^2 + (y - t^2)^2 = 4.$$

Since  $(t, t^2)$  parametrizes a parabola, we can think of equation (6) as describing the *family* of circles of radius 2 in  $\mathbb{R}^2$  whose centers lie on the parabola  $y = x^2$ . The picture is as follows:

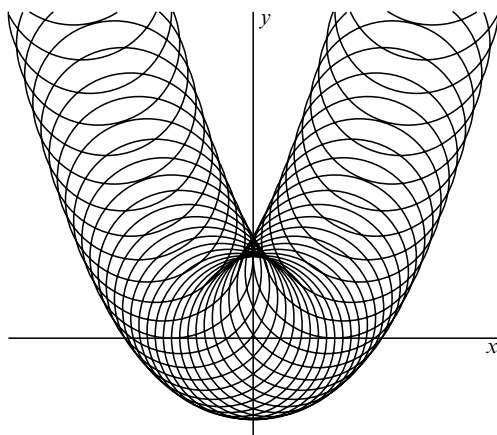

A Family of Circles in the Plane

Note that the “boundary” curve is *simultaneously tangent* to all the circles in the family. This is a special case of the *envelope* of a family of curves. The basic idea is that the envelope of a family of curves is a single curve that is tangent to all of the curves in the family. Our goal is to study envelopes and learn how to compute them. In particular, we want to find the equation of the envelope in the above example.

Before we can give a more careful definition of envelope, we must first understand the concept of a *family* of curves in  $\mathbb{R}^2$ .

**Definition 4.** Given a polynomial  $F \in \mathbb{R}[x, y, t]$ , fix a real number  $t \in \mathbb{R}$ . Then the variety in  $\mathbb{R}^2$  defined by  $F(x, y, t) = 0$  is denoted  $\mathbf{V}(F_t)$ , and the **family of curves** determined by  $F$  consists of the varieties  $\mathbf{V}(F_t)$  as  $t$  varies over  $\mathbb{R}$ .

In this definition, we think of  $t$  as a *parameter* that tells us which curve in the family we are looking at. Strictly speaking, we should say “family of varieties” rather than “family of curves,” but we will use the latter to emphasize the geometry of the situation.

For another example of a family and its envelope, consider the curves defined by

$$(7) \quad F(x, y, t) = (x - t)^2 - y + t = 0.$$

Writing this as  $y - t = (x - t)^2$ , we see in the picture at the top of the next page that (7) describes the family  $\mathbf{V}(F_t)$  of parabolas obtained by translating the standard parabola  $y = x^2$  along the straight line  $y = x$ . In this case, the envelope is clearly the straight line that just touches each parabola in the family. This line has slope 1, and from here, it is easy to check that the envelope is given by  $y = x - 1/4$  (the details are left as an exercise).

Not all envelopes are so easy to describe. The remarkable fact is that we can characterize the envelope in the following completely algebraic way.

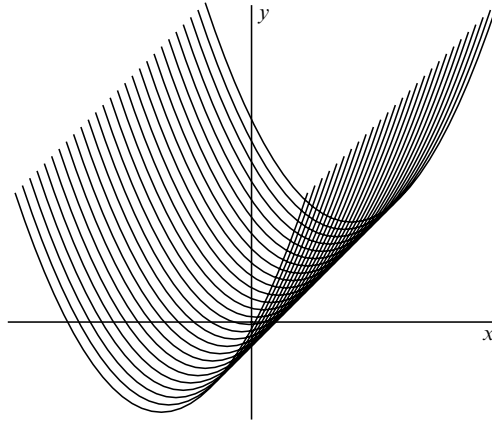

A Family of Parabolas in the Plane

**Definition 5.** Given a family  $\mathbf{V}(F_t)$  of curves in  $\mathbb{R}^2$ , its **envelope** consists of all points  $(x, y) \in \mathbb{R}^2$  with the property that

$$\begin{aligned} F(x, y, t) &= 0, \\ \frac{\partial}{\partial t} F(x, y, t) &= 0 \end{aligned}$$

for some  $t \in \mathbb{R}$ .

We need to explain how this definition corresponds to the intuitive idea of envelope. The argument given below is not rigorous, but it does explain where the condition on  $\frac{\partial}{\partial t} F$  comes from. A complete treatment of envelopes requires a fair amount of theoretical machinery. We refer the reader to Chapter 5 of BRUCE and GIBLIN (1992) for more details.

Given a family  $\mathbf{V}(F_t)$ , we think of the envelope as a curve  $C$  with the property that at each point on the curve,  $C$  is tangent to one of the curves  $\mathbf{V}(F_t)$  in the family. Suppose that  $C$  is parametrized by

$$\begin{aligned} x &= f(t), \\ y &= g(t). \end{aligned}$$

We will assume that at time  $t$ , the point  $(f(t), g(t))$  is on the curve  $\mathbf{V}(F_t)$ . This ensures that  $C$  meets all the members of the family. Algebraically, this means that

$$(8) \quad F(f(t), g(t), t) = 0 \quad \text{for all } t \in \mathbb{R}.$$

But when is  $C$  tangent to  $\mathbf{V}(F_t)$  at  $(f(t), g(t))$ ? This is what is needed for  $C$  to be the envelope of the family. We know from calculus that the tangent vector to  $C$  is



$(f'(t), g'(t))$ . As for  $\mathbf{V}(F_t)$ , we have the gradient  $\nabla F = \left( \frac{\partial}{\partial x} F, \frac{\partial}{\partial y} F \right)$ , and from the first part of this section, we know that  $\nabla F$  is perpendicular to the tangent line to  $\mathbf{V}(F_t)$ . Thus, for  $C$  to be tangent to  $\mathbf{V}(F_t)$ , the tangent  $(f'(t), g'(t))$  must be perpendicular to the gradient  $\nabla F$ . In terms of dot products, this means that  $\nabla F \cdot (f'(t), g'(t)) = 0$  or, equivalently,

$$(9) \quad \frac{\partial}{\partial x} F(f(t), g(t), t) \cdot f'(t) + \frac{\partial}{\partial y} F(f(t), g(t), t) \cdot g'(t) = 0.$$

We have thus shown that the envelope is determined by conditions (8) and (9). To relate this to Definition 5, differentiate (8) with respect to  $t$ . Using the chain rule, we get

$$\frac{\partial}{\partial x} F(f(t), g(t), t) \cdot f'(t) + \frac{\partial}{\partial y} F(f(t), g(t), t) \cdot g'(t) + \frac{\partial}{\partial t} F(f(t), g(t), t) = 0.$$

If we subtract equation (9) from this, we obtain

$$(10) \quad \frac{\partial}{\partial t} F(f(t), g(t), t) = 0.$$

From (8) and (10), it follows that  $(x, y) = (f(t), g(t))$  has exactly the property described in Definition 5.

As we will see later in the section, the above discussion of envelopes is rather naive. For us, the main consequence of Definition 5 is that the envelope of  $\mathbf{V}(F_t)$  is determined by the equations

$$\begin{aligned} F(x, y, t) &= 0, \\ \frac{\partial}{\partial t} F(x, y, t) &= 0. \end{aligned}$$

Note that  $x$  and  $y$  tell us where we are on the envelope and  $t$  tells us which curve in the family we are tangent to. Since these equations involve  $x$ ,  $y$ , and  $t$ , we need to eliminate  $t$  to find the equation of the envelope. Thus, we can apply the theory from §§1 and 2 to study the envelope of a family of curves.

Let us see how this works in example (6). Here,  $F = (x - t)^2 + (y - t^2)^2 - 4$ , so that the envelope is described by the equations

$$(11) \quad \begin{aligned} F &= (x - t)^2 + (y - t^2)^2 - 4 = 0, \\ \frac{\partial}{\partial t} F &= -2(x - t) - 4t(y - t^2) = 0. \end{aligned}$$

Using lexicographic order with  $t > x > y$ , a Groebner basis is given by

$$\begin{aligned} g_1 &= -1156 + 688x^2 - 191x^4 + 16x^6 + 544y + 30x^2y - 40x^4y \\ &\quad + 225y^2 - 96x^2y^2 + 16x^4y^2 - 136y^3 - 32x^2y^3 + 16y^4, \\ g_2 &= (7327 - 1928y - 768y^2 - 896y^3 + 256y^4)t + 6929x - 2946x^3 \\ &\quad + 224x^5 + 2922xy - 1480x^3y + 128x^5y - 792xy^2 - 224x^3y^2 \\ &\quad - 544xy^3 + 128x^3y^3 - 384xy^4, \end{aligned}$$

$$\begin{aligned}
 g_3 &= (431x - 12xy - 48xy^2 - 64xy^3)t + 952 - 159x^2 - 16x^4 + 320y \\
 &\quad - 214x^2y + 32x^4y - 366y^2 - 32x^2y^2 - 80y^3 + 32x^2y^3 + 32y^4, \\
 g_4 &= (697 - 288x^2 + 108y - 336y^2 + 64y^3)t + 23x - 174x^3 \\
 &\quad + 32x^5 + 322xy - 112x^3y + 32xy^2 + 32x^3y^2 - 96xy^3, \\
 g_5 &= 135t^2 + (26x + 40xy + 32xy^2)t - 128 + 111x^2 \\
 &\quad - 16x^4 + 64y + 8x^2y + 32y^2 - 16x^2y^2 - 16y^3.
 \end{aligned}$$

We have written the Groebner basis as polynomials in  $t$  with coefficients in  $\mathbb{R}[x, y]$ . The Elimination Theorem tells us that  $g_1$  generates the first elimination ideal. Thus, the envelope lies on the curve  $g_1 = 0$ . Here is a picture of  $\mathbf{V}(g_1)$  together with the parabola  $y = x^2$ :

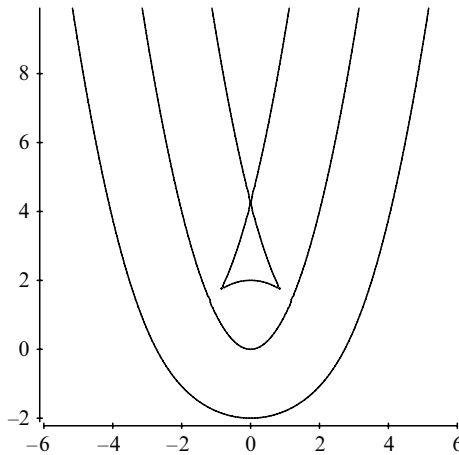

The surprise is the “triangular” portion of the graph that was somewhat unclear in the earlier picture of the family. By drawing some circles centered on the parabola, you can see how the triangle is still part of the envelope.

We have proved that the envelope lies on  $\mathbf{V}(g_1)$ , but the two may not be equal. In fact, there are two interesting questions to ask at this point:

- Is every point of  $\mathbf{V}(g_1)$ , on the envelope? This is the same as asking if every partial solution  $(x, y)$  of (11) extends to a complete solution  $(x, y, t)$ .
- Given a point on the envelope, how many curves in the family are tangent to the envelope at the point? This asks how many  $t$ 's are there for which  $(x, y)$  extends to  $(x, y, t)$ .

Since the leading coefficient of  $t$  in  $g_5$  is the constant 135, the Extension Theorem (in the form of Corollary 4 of §1) guarantees that *every* partial solution extends, *provided* we work over the complex numbers. Thus,  $t$  exists, but it might be complex. This illustrates the power and limitation of the Extension Theorem: it can guarantee that there is a solution, but it might lie in the wrong field.

In spite of this difficulty, the equation  $g_5 = 0$  does have something useful to tell us: it is quadratic in  $t$ , so that a given  $(x, y)$  extends in at most *two* ways to a complete solution. Thus, *a point on the envelope of (6) is tangent to at most two circles in the family*. Can you see any points where there are two tangent circles?

To get more information on what is happening, let us look at the other polynomials in the Groebner basis. Note that  $g_2, g_3$ , and  $g_4$  involve  $t$  only to the first power. Thus, we can write them in the form

$$g_i = A_i(x, y)t + B_i(x, y), \quad i = 2, 3, 4.$$

If  $A_i$  does not vanish at  $(x, y)$  for one of  $i = 2, 3, 4$ , then we can solve  $A_i t + B_i = 0$  to obtain

$$t = -\frac{B_i(x, y)}{A_i(x, y)}.$$

Thus, we see that  $t$  is real whenever  $x$  and  $y$  are. More importantly, this formula shows that  $t$  is uniquely determined when  $A_i(x, y) \neq 0$ . Thus, *a point on the envelope of (6) not in  $\mathbf{V}(A_2, A_3, A_4)$  is tangent to exactly one circle in the family*.

It remains to understand where  $A_2, A_3$ , and  $A_4$  vanish simultaneously. These polynomials might look complicated, but, using the techniques of §1, one can show that the real solutions of  $A_2 = A_3 = A_4 = 0$  are

$$(12) \quad (x, y) = (0, 17/4) \text{ and } (\pm 0.936845, 1.63988).$$

Looking back at the picture of  $\mathbf{V}(g_1)$ , it appears that these are the singular points of  $\mathbf{V}(g_1)$ . Can you see the two circles tangent at these points? From the first part of this section, we know that the singular points of  $\mathbf{V}(g_1)$  are determined by the equations  $g_1 = \frac{\partial}{\partial x} g_1 = \frac{\partial}{\partial y} g_1 = 0$ . Thus, to say that the singular points coincide with (12) means that

$$(13) \quad \mathbf{V}(A_2, A_3, A_4) = \mathbf{V}\left(g_1, \frac{\partial}{\partial x} g_1, \frac{\partial}{\partial y} g_1\right).$$

To prove this, we will show that

$$(14) \quad \begin{aligned} g_1, \frac{\partial}{\partial x} g_1, \frac{\partial}{\partial y} g_1 &\in \langle A_2, A_3, A_4 \rangle, \\ A_2^2, A_3^2, A_4^2 &\in \left\langle g_1, \frac{\partial}{\partial x} g_1, \frac{\partial}{\partial y} g_1 \right\rangle. \end{aligned}$$

The proof of (14) is a straightforward application of the ideal membership algorithm discussed in Chapter 2. For the first line, one computes a Groebner basis of  $\langle A_2, A_3, A_4 \rangle$  and then applies the algorithm for the ideal membership problem to each of  $g_1, \frac{\partial}{\partial x} g_1, \frac{\partial}{\partial y} g_1$  (see §8 of Chapter 2). The second line of (14) is treated similarly—the details will be left as an exercise.

Since (13) follows immediately from (14), we have proved that *a nonsingular point on  $\mathbf{V}(g_1)$ , is in the envelope of (6) and, at such a point, the envelope is tangent to exactly one circle in the family*. Also note that the singular points of  $\mathbf{V}(g_1)$  are the most interesting points in the envelope, for they are the ones where there are two tangent

circles. This last observation shows that singular points are not always bad—they can be a useful indication that something unusual is happening. An important part of algebraic geometry is devoted to the study of singular points.

In this example, equations (11) for the envelope were easy to write down. But to understand the equations, we had to use a Groebner basis and the Elimination and Extension Theorems. Even though the Groebner basis looked complicated, it told us exactly which points on the envelope were tangent to more than one circle. This illustrates nicely the power of the theory we have developed so far.

As we said earlier, our treatment of envelopes has been a bit naive. Evidence of this comes from the above example, which shows that the envelope can have singularities. How can the envelope be “tangent” to a curve in the family at a singular point? In the exercises, we will indicate another reason why our discussion has been too simple. We have also omitted the fascinating relation between the family of curves  $\mathbf{V}(F_t) \subset \mathbb{R}^2$  and the surface  $\mathbf{V}(F) \subset \mathbb{R}^3$  defined by  $F(x, y, t) = 0$ . We refer the reader to Chapter 5 of BRUCE and GIBLIN (1992) for a more complete treatment of these aspects of envelopes.

#### EXERCISES FOR §4

- Let  $C$  be the curve in  $k^2$  defined by  $x^3 - xy + y^2 = 1$  and note that  $(1, 1) \in C$ . Now consider the straight line parametrized by

$$\begin{aligned}x &= 1 + ct, \\y &= 1 + dt.\end{aligned}$$

Compute the multiplicity of this line when it meets  $C$  at  $(1, 1)$ . What does this tell you about the tangent line? Hint: There will be two cases to consider.

- In Definition 1, we need to show that the notion of multiplicity is independent of how the line is parametrized.
  - Show that two parametrizations

$$\begin{aligned}x &= a + ct, & x &= a + c't, \\y &= b + dt, & y &= b + d't,\end{aligned}$$

correspond to the same line if and only if there is a nonzero number  $\lambda \in k$  such that  $(c, d) = \lambda(c', d')$ . Hint: In the parametrization  $x = a + ct$ ,  $y = b + dt$  of a line  $L$ , recall that  $L$  is parallel to the vector  $(c, d)$ .

- Suppose that the two parametrizations of part a correspond to the same line  $L$  that meets  $\mathbf{V}(f)$  at  $(a, b)$ . Prove that the polynomials  $g(t) = f(a + ct, b + dt)$  and  $g'(t) = f(a + c't, b + d't)$  have the same multiplicity at  $t = 0$ . Hint: Use part a to relate  $g$  and  $g'$ . This will prove that the multiplicity of how  $L$  meets  $\mathbf{V}(f)$  at  $(a, b)$  is well defined.
- Consider the straight lines

$$\begin{aligned}x &= t, \\y &= b + t.\end{aligned}$$

These lines have slope 1 and y-intercept  $b$ . For which values of  $b$  is the line tangent to the circle  $x^2 + y^2 = 2$ ? Draw a picture to illustrate your answer. Hint: Consider  $g(t) = t^2 + (b + t)^2 - 2$ . The roots of this quadratic determine the values of  $t$  where the line meets the circle.

4. If  $(a, b) \in \mathbf{V}(f)$  and  $\nabla f(a, b) \neq (0, 0)$ , prove that the tangent line of  $\mathbf{V}(f)$  at  $(a, b)$  is defined by the equation

$$\frac{\partial}{\partial x} f(a, b) \cdot (x - a) + \frac{\partial}{\partial y} f(a, b) \cdot (y - b) = 0.$$

5. Let  $g \in k[t]$  be a polynomial such that  $g(0) = 0$ . Assume that  $\mathbf{Q} \subset k$ .
- Prove that  $t = 0$  is a root of multiplicity  $\geq 2$  of  $g$  if and only if  $g'(0) = 0$ . Hint: Write  $g(t) = th(t)$ , and use the product rule.
  - More generally, prove that  $t = 0$  is a root of multiplicity  $\geq k$  if and only if  $g'(0) = g''(0) = \dots = g^{(k-1)}(0) = 0$ .
6. As in the Definition 1, let a line  $L$  be parametrized by (1), where  $(a, b) \in \mathbf{V}(f)$ . Also let  $g(t) = f(a + ct, b + dt)$ . Prove that  $L$  meets  $\mathbf{V}(f)$  with multiplicity  $k$  if and only if  $g'(0) = g''(0) = \dots = g^{(k-1)}(0) = 0$  but  $g^{(k)}(0) \neq 0$ . Hint: Use the previous exercise.
7. In this exercise, we will study how a tangent line can meet a curve with multiplicity *greater* than 2. Let  $C$  be the curve defined by  $y = f(x)$ , where  $f \in k[x]$ . Thus,  $C$  is just the graph of  $f$ .
- Give an algebraic proof that the tangent line to  $C$  at  $(a, f(a))$  is parametrized by

$$\begin{aligned} x &= a + t, \\ y &= f(a) + f'(a)t. \end{aligned}$$

Hint: Consider  $g(t) = f(a) + f'(a)t - f(a + t)$ .

- Show that the tangent line at  $(a, f(a))$  meets the curve with multiplicity  $\geq 3$  if and only if  $f''(a) = 0$ . Hint: Use the previous exercise.
  - Show that the multiplicity is exactly 3 if and only if  $f''(a) = 0$  but  $f'''(a) \neq 0$ .
  - Over  $\mathbb{R}$ , a *point of inflection* is defined to be a point where  $f''(x)$  changes sign. Prove that if the multiplicity is 3, then  $(a, f(a))$  is a point of inflection.
8. In this problem, we will compute some singular points.
- Show that  $(0, 0)$  is the *only* singular point of  $y^2 = x^3$ .
  - In Exercise 8 of §3 of Chapter 1, we studied the curve  $y^2 = cx^2 - x^3$ , where  $c$  is some constant. Find all singular points of this curve and explain how your answer relates to the picture of the curve given in Chapter 1.
  - Show that the circle  $x^2 + y^2 = a^2$  in  $\mathbb{R}^2$  has no singular points when  $a > 0$ .
9. One use of multiplicities is to show that one singularity is “worse” than another.
- For the curve  $y^2 = x^3$ , show that most lines through the origin meet the curve with multiplicity exactly 2.
  - For  $x^4 + 2xy^2 + y^3 = 0$ , show that all lines through the origin meet the curve with multiplicity  $\geq 3$ .
- This suggests that the singularity at the origin is “worse” on the second curve. Using the ideas behind this exercise, one can define the notion of the *multiplicity* of a singular point.
10. We proved in the text that  $(0, 0)$  is a singular point of the curve  $C$  defined by  $y^2 = x^2(1+x)$ . But in the picture of  $C$ , it looks like there are two “tangent” lines through the origin. Can we use multiplicities to pick these out?
- Show that with two exceptions, all lines through the origin meet  $C$  with multiplicity 2. What are the lines that have multiplicity 3?
  - Explain how your answer to part (a) relates to the picture of  $C$  in the text. Why should the “tangent” lines have higher multiplicity?

11. The four-leaved rose is defined in polar coordinates by the equation  $r = \sin(2\theta)$ :

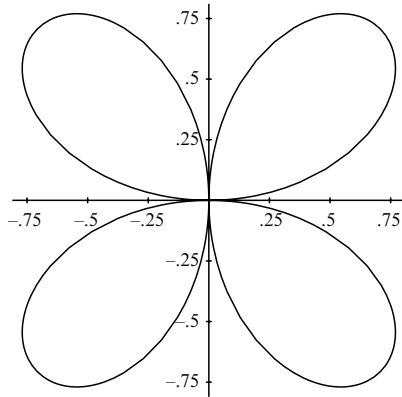

In Cartesian coordinates, this curve is defined by the equation  $(x^2 + y^2)^3 = 4x^2y^2$ .

- a. Show that most lines through the origin meet the rose with multiplicity 4 at the origin. Can you give a geometric explanation for this number?
  - b. Find the lines through the origin that meet the rose with multiplicity  $> 4$ . Give a geometric explanation for the numbers you get.
12. Consider a surface  $\mathbf{V}(f) \subset k^3$  defined by  $f \in k[x, y, z]$ .
- a. Define what it means for  $(a, b, c) \in \mathbf{V}(f)$  to be a singular point.
  - b. Determine all singular points of the sphere  $x^2 + y^2 + z^2 = 1$ . Does your answer make sense?
  - c. Determine all singular points on the surface  $\mathbf{V}(x^2 - y^2z^2 + z^3)$ . How does your answer relate to the picture of the surface drawn in §2 of Chapter 1?
13. Consider the family of curves given by  $F = xy - t \in \mathbb{R}[x, y, t]$ . Draw various of the curves  $\mathbf{V}(F_t)$  in the family. Be sure to include a picture of  $\mathbf{V}(F_0)$ .
14. This problem will study the envelope of the family  $F = (x - t)^2 - y + t$  considered in example (7).
- a. It is obvious that the envelope is a straight line of slope 1. Use elementary calculus to show that the line is  $y = x - 1/4$ .
  - b. Use Definition 5 to compute the envelope.
  - c. Find a parametrization of the envelope so that at time  $t$ , the point  $(f(t), g(t))$  is on the parabola  $\mathbf{V}(F_t)$ . Note that this is the kind of parametrization used in our discussion of Definition 5.
15. This problem is concerned with the envelope of example (6).
- a. Copy the picture in the text onto a sheet of paper and draw in the two tangent circles for each of the points in (12).
  - b. For the point  $(0, 4.25) = (0, 17/4)$ , find the exact values of the  $t$ 's that give the two tangent circles.
  - c. Show that the exact values of the points (12) are given by

$$\left(0, \frac{17}{4}\right) \quad \text{and} \quad \left(\pm\sqrt{15 + 6\sqrt[3]{2} - 12\sqrt[3]{4}}, \frac{1}{4}(-1 + 6\sqrt[3]{2})\right).$$

Hint: Most computer algebra systems have commands to factor polynomials and solve cubic equations.

16. Consider the family determined by  $F = (x - t)^2 + y^2 - (1/2)t^2$ .
- Compute the envelope of this family.
  - Draw a picture to illustrate your answer.
17. Consider the family of circles defined by  $(x - t)^2 + (y - t^2)^2 = t^2$  in the plane  $\mathbb{R}^2$ .
- Compute the equation of the envelope of this family and show that the envelope is the union of two varieties.
  - Use the Extension Theorem and a Groebner basis to determine, for each point in the envelope, how many curves in the family are tangent to it. Draw a picture to illustrate your answer. Hint: You will use a different argument for each of the two curves making up the envelope.
18. Prove (14) using the hints given in the text. Also show that  $A_2 \notin \langle g_1, \frac{\partial}{\partial x} g_1, \frac{\partial}{\partial y} g_1 \rangle$ . This shows that the ideals  $\langle g_1, \frac{\partial}{\partial x} g_1, \frac{\partial}{\partial y} g_1 \rangle$  and  $\langle A_2, A_3, A_4 \rangle$  are not equal, even though they define the same variety.
19. In this exercise, we will show that our definition of envelope is too naive.
- Given a family of circles of radius 1 with centers lying on the  $x$ -axis, draw a picture to show that the envelope consists of the lines  $y = \pm 1$ .
  - Use Definition 5 to compute the envelope of the family given by  $F = (x - t)^2 + y^2 - 1$ . Your answer should not be surprising.
  - Use Definition 5 to find the envelope when the family is  $F = (x - t^3)^2 + y^2 - 1$ . Note that one of the curves in the family is part of the answer. This is because using  $t^3$  allows the curves to “bunch up” near  $t = 0$ , which forces  $\mathbf{V}(F_0)$  to appear in the envelope.
- In our intuitive discussion of envelope, recall that we assumed we could parametrize the envelope so that  $(f(t), g(t))$  was in  $\mathbf{V}(F_t)$  at time  $t$ . This presumes that the envelope is tangent to *different* curves in the family. Yet in the example given in part (c), part of the envelope lies in the *same* curve in the family. Thus, our treatment of envelope was too simple.
20. Suppose we have a family of curves in  $\mathbb{R}^2$  determined by  $F \in \mathbb{R}[x, y, t]$ . Some of the curves  $\mathbf{V}(F_t)$  may have singular points, whereas others may not. Can we find the ones that have a singularity?
- By considering the equations  $F = \frac{\partial}{\partial x} F = \frac{\partial}{\partial y} F = 0$  in  $\mathbb{R}^3$  and using elimination theory, describe a procedure for determining those  $t$ 's corresponding to curves in the family which have a singular point.
  - Apply the method of part (a) to find the curves in the family of Exercise 13 that have singular points.

## §5 Unique Factorization and Resultants

The main task remaining in Chapter 3 is to prove the Extension Theorem. This will require that we learn some new algebraic tools concerning *unique factorization* and *resultants*. Both of these will be used in §6 when we prove the Extension Theorem. We will also make frequent use of unique factorization in later chapters of the book.

### *Irreducible Polynomials and Unique Factorization*

We begin with a basic definition.

**Definition 1.** Let  $k$  be a field. A polynomial  $f \in k[x_1, \dots, x_n]$  is **irreducible over  $k$**  iff  $f$  is nonconstant and is not the product of two nonconstant polynomials in  $k[x_1, \dots, x_n]$ .

This definition says that if a nonconstant polynomial  $f$  is irreducible over  $k$ , then up to a constant multiple, its only nonconstant factor is  $f$  itself. Also note that the concept of irreducibility depends on the field. For example,  $x^2 + 1$  is irreducible over  $\mathbb{Q}$  and  $\mathbb{R}$ , but, over  $\mathbb{C}$ , we have  $x^2 + 1 = (x - i)(x + i)$ .

Every polynomial is a product of irreducible polynomials as follows.

**Proposition 2.** *Every nonconstant polynomial  $f \in k[x_1, \dots, x_n]$  can be written as a product of polynomials which are irreducible over  $k$ .*

**Proof.** If  $f$  is irreducible over  $k$ , then we are done. Otherwise, we can write  $f = gh$ , where  $g, h \in k[x_1, \dots, x_n]$  are nonconstant. Note that the total degrees of  $g$  and  $h$  are less than the total degree of  $f$ . Now apply this process to  $g$  and  $h$ : if either fails to be irreducible over  $k$ , we factor it into nonconstant factors. Since the total degree drops each time we factor, this process can be repeated at most finitely many times. Thus,  $f$  must be a product of irreducibles.  $\square$

In Theorem 5 we will show that the factorization of Proposition 2 is essentially unique. But first, we have to prove the following crucial property of irreducible polynomials.

**Theorem 3.** *Let  $f \in k[x_1, \dots, x_n]$  be irreducible over  $k$  and suppose that  $f$  divides the product  $gh$ , where  $g, h \in k[x_1, \dots, x_n]$ . Then  $f$  divides  $g$  or  $h$ .*

**Proof.** We will use induction on the number of variables. When  $n = 1$ , we can use the GCD theory developed in §5 of Chapter 1. If  $f$  divides  $gh$ , then consider  $p = \text{GCD}(f, g)$ . If  $p$  is nonconstant, then  $f$  must be a constant multiple of  $p$  since  $f$  is irreducible, and it follows that  $f$  divides  $g$ . On the other hand, if  $p$  is constant, we can assume  $p = 1$ , and then we can find  $A, B \in k[x_1]$  such that  $Af + Bg = 1$  (see Proposition 6 of Chapter 1, §5). If we multiply this by  $h$ , we get

$$h = h(Af + Bg) = Ahf + Bgh.$$

Since  $f$  divides  $gh$ ,  $f$  is a factor of  $Ahf + Bgh$ , and, thus,  $f$  divides  $h$ . This proves the case  $n = 1$ .

Now assume that the theorem is true for  $n - 1$ . We first discuss the special case where the irreducible polynomial does not involve  $x_1$ :

(1)  $u \in k[x_2, \dots, x_n]$  irreducible,  $u$  divides  $gh \in k[x_1, \dots, x_n] \Rightarrow u$  divides  $g$  or  $h$ .

To prove this, write  $g = \sum_{i=0}^l a_i x_1^i$  and  $h = \sum_{i=0}^m b_i x_1^i$ , where  $a_i, b_i \in k[x_2, \dots, x_n]$ . If  $u$  divides every  $a_i$ , then  $u$  divides  $g$ , and similarly for  $h$ . Hence, if  $u$  divides neither, we can find  $i, j \geq 0$  such that  $u$  divides neither  $a_i$  nor  $b_j$ . We will assume that  $i$  and  $j$  are the smallest subscripts with this property. Then consider

$$c_{i+j} = (a_0 b_{i+j} + a_1 b_{i+j-1} + \dots + a_{i-1} b_{j+1}) + a_i b_j + (a_{i+1} b_{j-1} + \dots + a_{i+j} b_0).$$

By the way we chose  $i$ ,  $u$  divides every term inside the first set of parentheses and, by the choice of  $j$ , the same is true for the second set of parentheses. But  $u$  divides neither



$a_i$  nor  $b_j$ , and since  $u$  is irreducible, our inductive assumption implies that  $u$  does not divide  $a_i b_j$ . Since  $u$  divides all other terms of  $c_{i+j}$ , it cannot divide  $c_{i+j}$ . We leave it as an exercise to show that  $c_{i+j}$  is the coefficient of  $x_1^{i+j}$  in  $gh$ , and, hence,  $u$  cannot divide  $gh$ . This contradiction completes the proof of (1).

Now, given (1), we can treat the general case. Suppose that  $f$  divides  $gh$ . If  $f$  doesn't involve  $x_1$ , then we are done by (1). So assume that  $f$  is nonconstant in  $x_1$ . We will use the ring  $k(x_2, \dots, x_n)[x_1]$ , which is a polynomial ring in one variable over the field  $k(x_2, \dots, x_n)$ . Remember that elements of  $k(x_2, \dots, x_n)$  are quotients of polynomials in  $k[x_2, \dots, x_n]$ . We can regard  $k[x_1, \dots, x_n]$  as lying inside  $k(x_2, \dots, x_n)[x_1]$ . The strategy will be to work in the larger ring, where we know the theorem to be true, and then pass back to the smaller ring  $k[x_1, \dots, x_n]$ .

We claim that  $f$  is still irreducible when regarded as an element of  $k(x_2, \dots, x_n)[x_1]$ . To see why, suppose we had a factorization of  $f$  in the larger ring, say  $f = AB$ . Here,  $A$  and  $B$  are polynomials in  $x_1$  with coefficients in  $k(x_2, \dots, x_n)$ . To prove that  $f$  is irreducible here, we must show that  $A$  or  $B$  has degree 0 in  $x_1$ . Let  $d \in k[x_2, \dots, x_n]$  be the product of all denominators in  $A$  and  $B$ . Then  $\tilde{A} = dA$  and  $\tilde{B} = dB$  are in  $k[x_1, \dots, x_n]$ , and

$$(2) \quad d^2 f = \tilde{A} \tilde{B}$$

in  $k[x_1, \dots, x_n]$ . By Proposition 2, we can write  $d^2$  as a product of irreducible factors in  $k[x_2, \dots, x_n]$ , and, by (1), each of these divides  $\tilde{A}$  or  $\tilde{B}$ . We can cancel such a factor from both sides of (2), and after we have cancelled all of the factors, we are left with

$$f = \tilde{A}_1 \tilde{B}_1$$

in  $k[x_1, \dots, x_n]$ . Since  $f$  is irreducible in  $k[x_1, \dots, x_n]$ , this implies that  $\tilde{A}_1$  or  $\tilde{B}_1$  is constant. Now these polynomials were obtained from the original  $A, B$  by multiplying and dividing by various elements of  $k[x_2, \dots, x_n]$ . This shows that either  $A$  or  $B$  does not involve  $x_1$ , and our claim follows.

Now that  $f$  is irreducible in  $k(x_2, \dots, x_n)[x_1]$ , we know by the  $n = 1$  case of the theorem that  $f$  divides  $g$  or  $h$  in  $k(x_2, \dots, x_n)[x_1]$ . Say  $g = Af$  for some  $A \in k(x_2, \dots, x_n)[x_1]$ . If we clear denominators, we can write

$$(3) \quad dg = \tilde{A} f$$

in  $k[x_1, \dots, x_n]$ , where  $d \in k[x_2, \dots, x_n]$ . By (1), every irreducible factor of  $d$  divides  $\tilde{A}$  or  $f$ . The latter is impossible since  $f$  is irreducible and has positive degree in  $x_1$ . But each time an irreducible factor divides  $\tilde{A}$ , we can cancel it from both sides of (3). When all the cancellation is done, we see that  $f$  divides  $g$  in  $k[x_1, \dots, x_n]$ . This completes the proof of the theorem.  $\square$

In §6, we will need the following consequence of Theorem 3.

**Corollary 4.** *Suppose that  $f, g \in k[x_1, \dots, x_n]$  have positive degree in  $x_1$ . Then  $f$  and  $g$  have a common factor in  $k[x_1, \dots, x_n]$  of positive degree in  $x_1$  if and only if they have a common factor in  $k(x_2, \dots, x_n)[x_1]$ .*

**Proof.** If  $f$  and  $g$  have a common factor  $h$  in  $k[x_1, \dots, x_n]$  of positive degree in  $x_1$ , then they certainly have a common factor in the larger ring  $k(x_2, \dots, x_n)[x_1]$ . Going the other way, suppose that  $f$  and  $g$  have a common factor  $\tilde{h} \in k(x_2, \dots, x_n)[x_1]$ . Then

$$\begin{aligned} f &= \tilde{h}\tilde{f}_1, \quad \tilde{f}_1 \in k(x_2, \dots, x_n)[x_1]. \\ g &= \tilde{h}\tilde{g}_1, \quad \tilde{g}_1 \in k(x_2, \dots, x_n)[x_1]. \end{aligned}$$

Now  $\tilde{h}$ ,  $\tilde{f}_1$  and  $\tilde{g}_1$  may have denominators that are polynomials in  $k[x_2, \dots, x_n]$ . Letting  $d \in k[x_2, \dots, x_n]$  be a common denominator of these polynomials, we get  $h = d\tilde{h}$ ,  $f_1 = d\tilde{f}_1$  and  $g_1 = d\tilde{g}_1$  in  $k[x_1, \dots, x_n]$ . If we multiply each side of the above equations by  $d^2$ , we obtain

$$\begin{aligned} d^2 f &= h f_1, \\ d^2 g &= h g_1 \end{aligned}$$

in  $k[x_1, \dots, x_n]$ . Now let  $h_1$  be an irreducible factor of  $h$  of positive degree in  $x_1$ . Since  $\tilde{h} = h/d$  has positive degree in  $x_1$ , such an  $h_1$  must exist. Then  $h_1$  divides  $d^2 f$ , so that it divides  $d^2$  or  $f$  by Theorem 3. The former is impossible because  $d^2 \in k[x_2, \dots, x_n]$  and, hence,  $h_1$  must divide  $f$  in  $k[x_1, \dots, x_n]$ . A similar argument shows that  $h_1$  divides  $g$ , and thus  $h_1$  is the required common factor. This completes the proof of the corollary.  $\square$

Theorem 3 says that irreducible polynomials behave like prime numbers, in that if a prime divides a product of two integers, it must divide one or the other. This property of primes is the key to unique factorization of integers, and the same is true for irreducible polynomials.

**Theorem 5.** *Every nonconstant  $f \in k[x_1, \dots, x_n]$  can be written as a product  $f = f_1 \cdot f_2 \cdots f_r$  of irreducibles over  $k$ . Further, if  $f = g_1 \cdot g_2 \cdots g_s$  is another factorization into irreducibles over  $k$ , then  $r = s$  and the  $g_i$ 's can be permuted so that each  $f_i$  is a constant multiple of  $g_i$ .*

**Proof.** The proof will be covered in the exercises.  $\square$

For polynomials in  $\mathbb{Q}[x_1, \dots, x_n]$ , there are algorithms for factoring into irreducibles over  $\mathbb{Q}$ . A classical algorithm due to Kronecker is discussed in Theorem 4.8 of MINES, RICHMAN, and RUITENBERG (1988), and a more efficient method is given in DAVENPORT, SIRET and TOURNIER (1993) or MIGNOTTE (1992). Most computer algebra systems have a command for factoring polynomials in  $\mathbb{Q}[x_1, \dots, x_n]$ . Factoring polynomials in  $\mathbb{R}[x_1, \dots, x_n]$  or  $\mathbb{C}[x_1, \dots, x_n]$  is much more difficult.

## Resultants

Although resultants have a different flavor from what we have done so far, they play an important role in elimination theory. We will introduce the concept of resultant by asking when two polynomials in  $k[x]$  have a common factor. This might seem far removed from

elimination, but we will see the connection by the end of the section. In §6, we will study the resultant of two polynomials in  $k[x_1, \dots, x_n]$ , and we will then use resultants to prove the Extension Theorem. Suppose that we want to know whether two polynomials  $f, g \in k[x]$  have a common factor (which means a polynomial  $h \in k[x]$  of degree  $> 0$  which divides  $f$  and  $g$ ). One way would be to factor  $f$  and  $g$  into irreducibles. Unfortunately, factoring can be a time-consuming process. A more efficient method would be to compute the GCD of  $f$  and  $g$  using the Euclidean Algorithm from Chapter 1. A drawback is that the Euclidean Algorithm requires divisions in the field  $k$ . As we will see later, this is something we want to avoid when doing elimination. So is there a way of determining whether a common factor exists without doing any divisions in  $k$ ? Here is a first answer.

**Lemma 6.** *Let  $f, g \in k[x]$  be polynomials of degrees  $l > 0$  and  $m > 0$ , respectively. Then  $f$  and  $g$  have a common factor if and only if there are polynomials  $A, B \in k[x]$  such that:*

- (i)  $A$  and  $B$  are not both zero.
- (ii)  $A$  has degree at most  $m - 1$  and  $B$  has degree at most  $l - 1$ .
- (iii)  $Af + Bg = 0$ .

**Proof.** First, assume that  $f$  and  $g$  have a common factor  $h \in k[x]$ . Then  $f = hf_1$  and  $g = hg_1$ , where  $f_1, g_1 \in k[x]$ . Note that  $f_1$  has degree at most  $l - 1$ , and similarly  $\deg(g_1) \leq m - 1$ . Then

$$g_1 \cdot f + (-f_1) \cdot g = g_1 \cdot hf_1 - f_1 \cdot hg_1 = 0.$$

and, thus,  $A = g_1$  and  $B = -f_1$  have the required properties.

Conversely, suppose that  $A$  and  $B$  have the above three properties. By (i), we may assume  $B \neq 0$ . If  $f$  and  $g$  have no common factor, then their GCD is 1, so we can find polynomials  $\tilde{A}, \tilde{B} \in k[x]$  such that  $\tilde{A}f + \tilde{B}g = 1$  (see Proposition 6 of Chapter 1, §5). Now multiply by  $B$  and use  $Bg = -Af$ :

$$B = (\tilde{A}f + \tilde{B}g)B = \tilde{A}Bf + \tilde{B}Bg = \tilde{A}Bf - \tilde{B}Af = (\tilde{A}B - \tilde{B}A)f.$$

Since  $B$  is nonzero, this equation shows that  $B$  has degree at least  $l$ , which contradicts (ii). Hence, there must be a common factor of positive degree.  $\square$

The answer given by Lemma 6 may not seem very satisfactory, for we still need to decide whether the required  $A$  and  $B$  exist. Remarkably, we can use *linear algebra* to answer this last question. The idea is to turn  $Af + Bg = 0$  into a system of linear equations. Write:

$$\begin{aligned} A &= c_0x^{m-1} + \dots + c_{m-1}, \\ B &= d_0x^{l-1} + \dots + d_{l-1}, \end{aligned}$$

where for now we will regard the  $l + m$  coefficients  $c_0, \dots, c_{m-1}, d_0, \dots, d_{l-1}$  as

unknowns. Our goal is to find  $c_i, d_i \in k$ , not all zero, so that the equation

$$(4) \quad Af + Bg = 0$$

holds. Note that this will automatically give us  $A$  and  $B$  as required in Lemma 6.

To get a system of linear equations, let us also write out  $f$  and  $g$ :

$$f = a_0x^l + \dots + a_l, \quad a_0 \neq 0, \\ g = b_0x^m + \dots + b_m, \quad b_0 \neq 0,$$

where  $a_i, b_i \in k$ . If we substitute these formulas for  $f, g, A$ , and  $B$  into equation (4) and compare the coefficients of powers of  $x$ , then we get the following system of linear equations with unknowns  $c_i, d_i$  and coefficients  $a_i, b_i$ , in  $k$ :

$$(5) \quad \begin{matrix} a_0c_0 & & + & b_0d_0 & & = & 0 & \text{coefficient of } x^{l+m-1} \\ a_1c_0 + a_0c_1 & & + & b_1d_0 + b_0d_1 & & = & 0 & \text{coefficient of } x^{l+m-2} \\ & \ddots & & & & & \vdots & \\ & & a_lc_{m-1} & + & b_md_{l-1} & = & 0 & \text{coefficient of } x^0. \end{matrix}$$

Since there are  $l + m$  linear equations and  $l + m$  unknowns, we know from linear algebra that there is a nonzero solution if and only if the coefficient matrix has zero determinant. This leads to the following definition.

**Definition 7.** Given polynomials  $f, g \in k[x]$  of positive degree, write them in the form

$$f = a_0x^l + \dots + a_l, \quad a_0 \neq 0, \\ g = b_0x^m + \dots + b_m, \quad b_0 \neq 0.$$

Then the **Sylvester matrix** of  $f$  and  $g$  with respect to  $x$ , denoted  $\text{Syl}(f, g, x)$  is the coefficient matrix of the system of equations given in (5). Thus,  $\text{Syl}(f, g, x)$  is the following  $(l + m) \times (l + m)$  matrix:

$$\text{Syl}(f, g, x) = \left( \begin{array}{cccc|cccc} a_0 & & & & b_0 & & & \\ a_1 & a_0 & & & b_1 & b_0 & & \\ a_2 & a_1 & \ddots & & b_2 & b_1 & \ddots & \\ \vdots & & \ddots & & \vdots & & \ddots & b_0 \\ & \vdots & & a_0 & & & & \\ a_l & & & a_1 & & \vdots & & b_1 \\ & & & & b_m & & & \\ & a_l & & \vdots & & b_m & & \vdots \\ & & \ddots & & & & \ddots & \\ & & & a_l & & & & b_m \end{array} \right),$$

m columns
l columns

where the empty spaces are filled by zeros. The **resultant** of  $f$  and  $g$  with respect to  $x$ , denoted  $\text{Res}(f, g, x)$ , is the determinant of the Sylvester matrix. Thus,

$$\text{Res}(f, g, x) = \det(\text{Syl}(f, g, x)).$$

From this definition, we get the following properties of the resultant. A polynomial is called an *integer polynomial* provided that all of its coefficients are integers.

**Proposition 8.** *Given  $f, g \in k[x]$  of positive degree, the resultant  $\text{Res}(f, g, x) \in k$  is an integer polynomial in the coefficients of  $f$  and  $g$ . Furthermore,  $f$  and  $g$  have a common factor in  $k[x]$  if and only if  $\text{Res}(f, g, x) = 0$ .*

**Proof.** The standard formula for the determinant of an  $s \times s$  matrix  $A = (a_{ij})_{1 \leq i, j \leq s}$  is

$$\det(A) = \sum_{\substack{\sigma \text{ a permutation} \\ \text{of } \{1, \dots, s\}}} \text{sgn}(\sigma) a_{1\sigma(1)} \cdot a_{2\sigma(2)} \cdots a_{s\sigma(s)},$$

where  $\text{sgn}(\sigma)$  is  $+1$  if  $\sigma$  interchanges an even number of pairs of elements of  $\{1, \dots, s\}$  and  $-1$  if  $\sigma$  interchanges an odd number of pairs (see Appendix A for more details). This shows that the determinant is an integer polynomial (in fact, the coefficients are  $\pm 1$ ) in its entries, and the first statement of the proposition then follows immediately from the definition of resultant.

The second statement is just as easy to prove: the resultant is zero  $\Leftrightarrow$  the coefficient matrix of equations (5) has zero determinant  $\Leftrightarrow$  equations (5) have a nonzero solution. We observed earlier that this is equivalent to the existence of  $A$  and  $B$  as in Lemma 6, and then Lemma 6 completes the proof of the proposition.  $\square$

As an example, let us see if  $f = 2x^2 + 3x + 1$  and  $g = 7x^2 + x + 3$  have a common factor in  $\mathbb{Q}[x]$ . One computes that

$$\text{Res}(f, g, x) = \det \begin{pmatrix} 2 & 0 & 7 & 0 \\ 3 & 2 & 1 & 7 \\ 1 & 3 & 3 & 1 \\ 0 & 1 & 0 & 3 \end{pmatrix} = 153 \neq 0,$$

so that there is no common factor.

One disadvantage to using resultants is that large determinants are hard to compute. In the exercises, we will explain an alternate method for computing resultants that is similar to the Euclidean Algorithm. Most computer algebra systems have a resultant command that implements this algorithm.

To link resultants to elimination, let us compute the resultant of the polynomials  $f = xy - 1$  and  $g = x^2 + y^2 - 4$ . Regarding  $f$  and  $g$  as polynomials in  $x$  whose coefficients are polynomials in  $y$ , we get

$$\text{Res}(f, g, x) = \det \begin{pmatrix} y & 0 & 1 \\ -1 & y & 0 \\ 0 & -1 & y^2 - 4 \end{pmatrix} = y^4 - 4y^2 + 1.$$

More generally, if  $f$  and  $g$  are *any* polynomials in  $k[x, y]$  in which  $x$  appears to a positive power, then we can compute  $\text{Res}(f, g, x)$  in the same way. Since the coefficients are polynomials in  $y$ , Proposition 8 guarantees that  $\text{Res}(f, g, x)$  is a polynomial in  $y$ . Thus, given  $f, g \in k[x, y]$ , we can use the resultant to eliminate  $x$ . But is this the same kind of

elimination that we did in §§1 and 2? In particular, is  $\text{Res}(f, g, x)$  in the first elimination ideal  $\langle f, g \rangle \cap k[y]$ ? To answer these questions, we will need the following result.

**Proposition 9.** *Given  $f, g \in k[x]$  of positive degree, there are polynomials  $A, B \in k[x]$  such that*

$$Af + Bg = \text{Res}(f, g, x).$$

*Furthermore, the coefficients of  $A$  and  $B$  are integer polynomials in the coefficients of  $f$  and  $g$ .*

**Proof.** The definition of resultant was based on the equation  $Af + Bg = 0$ . In this proof, we will apply the same methods to the equation

$$(6) \quad \tilde{A}f + \tilde{B}g = 1.$$

The reason for using  $\tilde{A}$  rather than  $A$  will soon be apparent.

The proposition is trivially true if  $\text{Res}(f, g, x) = 0$  (simply choose  $A = B = 0$ ), so we may assume  $\text{Res}(f, g, x) \neq 0$ . Now let

$$\begin{aligned} f &= a_0x^l + \cdots + a_l, & a_0 &\neq 0, \\ g &= b_0x^m + \cdots + b_m, & b_0 &\neq 0, \\ \tilde{A} &= c_0x^{m-1} + \cdots + c_{m-1}, \\ \tilde{B} &= d_0x^{l-1} + \cdots + d_{l-1}, \end{aligned}$$

where  $c_0, \dots, c_{m-1}, d_0, \dots, d_{l-1}$  are unknowns in  $k$ . Equation (6) holds if and only if substituting these formulas into (6) gives an equality of polynomials. Comparing coefficients of powers of  $x$ , we conclude that (6) is equivalent to the following system of linear equations with unknowns  $c_i, d_i$  and coefficients  $a_i, b_i$  in  $k$ :

$$(7) \quad \begin{array}{rcccl} a_0c_0 & + & b_0d_0 & = & 0 & \text{coefficient of } x^{l+m-1} \\ a_1c_0 + a_0c_1 & + & b_1d_0 + b_0d_1 & = & 0 & \text{coefficient of } x^{l+m-2} \\ \vdots & & \vdots & & \vdots & \\ a_l c_{m-1} & + & b_m d_{l-1} & = & 1 & \text{coefficient of } x^0. \end{array}$$

These equations are the same as (5) except for the 1 on the right-hand side of the last equation. Thus, the coefficient matrix is the Sylvester matrix of  $f$  and  $g$ , and then  $\text{Res}(f, g, x) \neq 0$  guarantees that (7) has a unique solution in  $k$ .

In this situation, we can use *Cramer's Rule* to give a formula for the unique solution. Cramer's Rule states that the  $i$ -th unknown is a ratio of two determinants, where the denominator is the determinant of the coefficient matrix and the numerator is the determinant of the matrix where the  $i$ -th column of the coefficient matrix has been replaced by the right-hand side of the equation. For a more precise statement of Cramer's rule, the reader should consult Appendix A. In our case, Cramer's rule gives formulas

for the  $c_i$ 's and  $d_i$ 's. For example, the first unknown  $c_0$  is given by

$$c_0 = \frac{1}{\text{Res}(f, g, x)} \det \begin{pmatrix} 0 & & & & & b_0 \\ 0 & a_0 & & & & \vdots \\ \vdots & \vdots & \ddots & & & \vdots \\ 0 & a_l & & a_0 & b_m & \vdots \\ \vdots & & \ddots & \vdots & & \vdots \\ 1 & & & a_l & & b_m \end{pmatrix}.$$

Since a determinant is an integer polynomial in its entries, it follows that

$$c_0 = \frac{\text{an integer polynomial in } a_i, b_i}{\text{Res}(f, g, x)}.$$

There are similar formulas for the other  $c_i$ 's and the other  $d_i$ 's. Since  $\tilde{A} = c_0x^{m-1} + \cdots + c_{m-1}$ , we can pull out the common denominator  $\text{Res}(f, g, x)$  and write  $\tilde{A}$  in the form

$$\tilde{A} = \frac{1}{\text{Res}(f, g, x)} A,$$

where  $A \in k[x]$  and the coefficients of  $A$  are integer polynomials in  $a_i, b_i$ . Similarly, we can write

$$\tilde{B} = \frac{1}{\text{Res}(f, g, x)} B,$$

where  $B \in k[x]$  has the same properties as  $A$ . Since  $\tilde{A}$  and  $\tilde{B}$  satisfy  $\tilde{A}f + \tilde{B}g = 1$ , we can multiply through by  $\text{Res}(f, g, x)$  to obtain

$$Af + Bg = \text{Res}(f, g, x).$$

Since  $A$  and  $B$  have the required kind of coefficients, the proposition is proved.  $\square$

Most courses in linear algebra place little emphasis on Cramer's rule, mainly because Gaussian elimination is much more efficient (from a computational point of view) than Cramer's rule. But for theoretical uses, where one needs to worry about the *form* of the solution, Cramer's rule is very important (as shown by the above proposition).

We can now explain the relation between the resultant and the GCD. Given  $f, g \in k[x]$ ,  $\text{Res}(f, g, x) \neq 0$  tells us that  $f$  and  $g$  have no common factor, and hence their GCD is 1. Then Proposition 6 of Chapter 1, §5 says that there are  $\tilde{A}$  and  $\tilde{B}$  such that  $\tilde{A}f + \tilde{B}g = 1$ . As the above formulas for  $\tilde{A}$  and  $\tilde{B}$  make clear, the coefficients of  $\tilde{A}$  and  $\tilde{B}$  have a denominator given by the resultant (though the resultant need not be the smallest denominator). Then clearing these denominators leads to  $Af + Bg = \text{Res}(f, g, x)$ .

To see this more explicitly, let us return to the case of  $f = xy - 1$  and  $g = x^2 + y^2 - 4$ . If we regard these as polynomials in  $x$ , then we computed that  $\text{Res}(f, g, x) = y^4 - 4y^2 + 1 \neq 0$ . Thus, their GCD is 1, and we leave it as an exercise to check

that

$$-\left(\frac{y}{y^4 - 4y^2 + 1}x + \frac{1}{y^4 - 4y^2 + 1}\right)f + \frac{y^2}{y^4 - 4y^2 + 1}g = 1.$$

Note that this equation takes place in  $k(y)[x]$ , i.e., the coefficients are *rational functions* in  $y$ . This is because the GCD theory from §5 of Chapter 1 requires *field* coefficients. If we want to work in  $k[x, y]$ , we must clear denominators, which leads to

$$(8) \quad -(yx + 1)f + y^2g = y^4 - 4y^2 + 1.$$

This, of course, is just a special case of Proposition 9. Hence, we can regard the resultant as a “denominator-free” version of the GCD.

We have now answered the question posed before Proposition 9, for (8) shows that the resultant  $y^4 - 4y^2 + 1$  is in the elimination ideal. More generally, it is clear that if  $f, g \in k[x, y]$  are any polynomials of positive degree in  $x$ , then  $\text{Res}(f, g, x)$  always lies in the first elimination ideal of  $\langle f, g \rangle$ . In §6, we see how these ideas apply to the case of  $f, g \in k[x_1, \dots, x_n]$ .

In addition to the resultant of two polynomials discussed here, the resultant of three or more polynomials can be defined. Readers interested in *multipolynomial resultants* should consult MACAULAY (1902) or VAN DER WAERDEN (1931). Modern introductions to this theory can be found in BAJAJ, GARRITY and WARREN (1988), CANNY and MANOCHA (1993), or COX, LITTLE and O’ SHEA (1998). A more sophisticated treatment of resultants is presented in JOUANOLOU (1991), and a vast generalization of the concept of resultant is discussed in GELFAND, KAPRANOV and ZELEVINSKY (1994).

## EXERCISES FOR §5

- Here are some examples of irreducible polynomials.
  - Show that every  $f \in k[x]$  of degree 1 is irreducible over  $k$ .
  - Let  $f \in k[x]$  have degree 2 or 3. Show that  $f$  is irreducible over  $k$  if and only if  $f$  has no roots in  $k$ .
  - Use part (b) to show that  $x^2 - 2$  and  $x^3 - 2$  are irreducible over  $\mathbb{Q}$  but not over  $\mathbb{R}$ .
  - Prove that  $x^4 + 1$  is irreducible over  $\mathbb{Q}$  but not over  $\mathbb{R}$ . This one is a bit harder.
  - Use part (d) to show that part (b) can fail for polynomials of degree  $\geq 4$ .
- Prove that a field  $k$  is algebraically closed if and only if every irreducible polynomial in  $k[x]$  has degree 1.
- This exercise is concerned with the proof of Theorem 3. Suppose that  $g = \sum_i a_i x_1^i$  and  $h = \sum_i b_i x_1^i$ , where  $a_i, b_i \in k[x_2, \dots, x_n]$ .
  - Let  $u \in k[x_2, \dots, x_n]$ . Show that  $u$  divides  $g$  in  $k[x_1, \dots, x_n]$  if and only if, in  $k[x_2, \dots, x_n]$ ,  $u$  divides every  $a_i$ .
  - If we write  $gh = \sum_i c_i x_1^i$ , verify that  $c_{i+j}$  is given by the formula that appears in the proof of Theorem 3.
- In this exercise, we will prove Theorem 5.
  - If  $f$  is irreducible and divides a product  $h_1 \cdots h_s$ , then prove that  $f$  divides  $h_i$  for some  $i$ .
  - The existence of a factorization follows from Proposition 2. Now prove the uniqueness part of Theorem 5. Hint: If  $f = f_1 \cdots f_r = g_1 \cdots g_s$ , where the  $f_i$ 's and  $g_j$ 's are



irreducible, apply part a to show that  $f_1$  divides some  $g_j$ . Then argue  $g_j$  is a constant multiple of  $f_1$ , and hence we can cancel  $f_1$  from each side. Use induction on the total degree of  $f$ .

5. Compute the resultant of  $x^5 - 3x^4 - 2x^3 + 3x^2 + 7x + 6$  and  $x^4 + x^2 + 1$ . Do these polynomials have a common factor in  $\mathbb{Q}[x]$ ? Explain your reasoning.
6. In Exercise 14 of Chapter 1, §5, we proved that if  $f = c(x - a_1)^{r_1} \cdots (x - a_l)^{r_l} \in \mathbb{C}[x]$ , then

$$\text{GCD}(f, f') = (x - a_1)^{r_1-1} \cdots (x - a_l)^{r_l-1}.$$

Over an arbitrary field  $k$ , a given polynomial  $f \in k[x]$  of positive degree may not be a product of linear factors. But by unique factorization, we know that  $f$  can be written in the form

$$f = cf_1^{r_1} \cdots f_l^{r_l}, \quad c \in k,$$

where  $f_1, \dots, f_l \in k[x]$  are irreducible and no  $f_i$  is a constant multiple of  $f_j$  for  $j \neq i$ . Prove that if  $k$  contains the rational numbers  $\mathbb{Q}$ , then

$$\text{GCD}(f, f') = f_1^{r_1-1} \cdots f_l^{r_l-1}.$$

Hint: Follow the outline of Exercise 14 of Chapter 1, §5. Your proof will use unique factorization. The hypothesis  $\mathbb{Q} \subset k$  is needed to ensure that  $f' \neq 0$ .

7. If  $f, g \in \mathbb{C}[x]$  are polynomials of positive degree, prove that  $f$  and  $g$  have a common root in  $\mathbb{C}$  if and only if  $\text{Res}(f, g, x) = 0$ . Hint: Use Proposition 8 and the fact that  $\mathbb{C}$  is algebraically closed.
8. If  $f = a_0x^l + \cdots + a_l \in k[x]$ , where  $a_0 \neq 0$  and  $l > 0$ , then the *discriminant* of  $f$  is defined to be

$$\text{disc}(f) = \frac{(-1)^{l(l-1)/2}}{a_0} \text{Res}(f, f', x).$$

Prove that  $f$  has a multiple factor (i.e.,  $f$  is divisible by  $h^2$  for some  $h \in k[x]$  of positive degree) if and only if  $\text{disc}(f) = 0$ . Hint: Use Exercise 6 (you may assume  $\mathbb{Q} \subset k$ ). Over the complex numbers, Exercise 7 implies that a polynomial has a multiple root if and only if its discriminant is zero.

9. Use the previous exercise to determine whether or not  $6x^4 - 23x^3 + 32x^2 - 19x + 4$  has a multiple root in  $\mathbb{C}$ . What is the multiple root?
10. Compute the discriminant of the quadratic polynomial  $f = ax^2 + bx + c$ . Explain how your answer relates to the quadratic formula, and, without using Exercise 8, prove that  $f$  has a multiple root if and only if its discriminant vanishes.
11. Consider the polynomials  $f = 2x^2 + 3x + 1$  and  $g = 7x^2 + x + 3$ .
  - a. Use the Euclidean Algorithm (by hand, not computer) to find the GCD of these polynomials.
  - b. Find polynomials  $A, B \in \mathbb{Q}[x]$  such that  $Af + Bg = 1$ . Hint: Use the calculations you made in part a.
  - c. In the equation you found in part b, clear the denominators. How does this answer relate to the resultant?
12. If  $f, g \in \mathbb{Z}[x]$ , explain why  $\text{Res}(f, g, x) \in \mathbb{Z}$ .
13. Let  $f = xy - 1$  and  $g = x^2 + y^2 - 4$ . We will regard  $f$  and  $g$  as polynomials in  $x$  with coefficients in  $k(y)$ .

- a. With  $f$  and  $g$  as above, set up the system of equations (7) that describes  $\tilde{A}f + \tilde{B}g = 1$ . Hint:  $\tilde{A}$  is linear and  $\tilde{B}$  is constant. Thus, you should have three equations in three unknowns.
  - b. Use Cramer's rule to solve the system of equations obtained in part (a). Hint: The denominator is the resultant.
  - c. What equation do you get when you clear denominators in part (b)? Hint: See equation (8) in the text.
14. In the text, we defined  $\text{Res}(f, g, x)$  when  $f, g \in k[x]$  have positive degree. In this problem, we will explore what happens when one (or both) of  $f$  and  $g$  are constant.
- a. First, assume that  $f$  has degree  $l > 0$  and  $g = b_0$  is constant (possibly 0). Show that the Sylvester matrix of  $f$  and  $g$  is the  $l \times l$  matrix with  $b_0$  on the main diagonal and 0's elsewhere. Conclude that  $\text{Res}(f, b_0, x) = b_0^l$ .
  - b. When  $f$  and  $g$  are as in part a, show that Propositions 8 and 9 are still true.
  - c. What is  $\text{Res}(a_0, g, x)$  when  $f = a_0$  is constant (possibly zero) and  $g$  has degree  $m > 0$ ? Explain your reasoning.
  - d. The one case not covered so far is when both  $f = a_0$  and  $g = b_0$  are constants. In this case, one defines.

$$\text{Res}(a_0, b_0) = \begin{cases} 0 & \text{if either } a_0 = 0 \text{ or } b_0 = 0 \\ 1 & \text{if } a_0 \neq 0 \text{ and } b_0 \neq 0. \end{cases}$$

By considering  $f = g = 2$  in  $\mathbb{Q}[x]$ , show that Propositions 8 and 9 can fail when  $f$  and  $g$  are constant. Hint: Look at the statements requiring that certain things be integer polynomials in the coefficients of  $f$  and  $g$ .

15. Prove that if  $f$  has degree  $l$  and  $g$  has degree  $m$ , then the resultant has the following symmetry property:

$$\text{Res}(f, g, x) = (-1)^{lm} \text{Res}(g, f, x).$$

Hint: A determinant changes sign if you switch two columns.

16. Let  $f = a_0x^l + \dots + a_l$  and  $g = b_0x^m + \dots + b_m$  be polynomials in  $k[x]$ , and assume that  $l \geq m$ .
- a. Let  $\tilde{f} = f - (a_0/b_0)x^{l-m}g$ , so that  $\deg(\tilde{f}) \leq l - 1$ . If  $\deg(\tilde{f}) = l - 1$ , then prove

$$\text{Res}(f, g, x) = (-1)^m b_0 \text{Res}(\tilde{f}, g, x).$$

Hint: Use column operations on the Sylvester matrix. You will subtract  $a_0/b_0$  times the first  $m$  columns in the  $g$  part from the columns in the  $f$  part. Then expand by minors along the first row. [See Theorem 5.7 of FINKBEINER (1978) for a description of expansion by minors.]

- b. Let  $\tilde{f}$  be as in part (a), but this time we allow the possibility that the degree of  $\tilde{f}$  could be strictly smaller than  $l - 1$ . Prove that

$$\text{Res}(f, g, x) = (-1)^{m(l - \deg(\tilde{f}))} b_0^{l - \deg(\tilde{f})} \text{Res}(\tilde{f}, g, x).$$

Hint: The exponent  $l - \deg(\tilde{f})$  tells you how many times to expand by minors.

- c. Now use the division algorithm to write  $f = qg + r$  in  $k[x]$ , where  $\deg(r) < \deg(g)$ . Then use part (b) to prove that

$$\text{Res}(f, g, x) = (-1)^{m(l - \deg(r))} b_0^{l - \deg(r)} \text{Res}(r, g, x).$$

17. In this exercise, we will modify the Euclidean Algorithm to give an algorithm for computing resultants. The basic idea is the following: to find the GCD of  $f$  and  $g$ , we used the division

algorithm to write  $f = qg + r$ ,  $g = q'r + r'$ , etc. In equation (5) of Chapter 1, §5, the equalities

$$\text{GCD}(f, g) = \text{GCD}(g, r) = \text{GCD}(r, r') = \dots$$

enabled us to compute the GCD since the degrees were decreasing. Using Exercises 15 and 16, we get the following “resultant” version of the first two equalities above:

$$\begin{aligned} \text{Res}(f, g, x) &= (-1)^{\deg(g)(\deg(f)-\deg(r))} b_0^{\deg(f)-\deg(r)} \text{Res}(r, g, x) \\ &= (-1)^{\deg(f)\deg(g)} b_0^{\deg(f)-\deg(r)} \text{Res}(g, r, x) \\ &= (-1)^{\deg(f)\deg(g)+\deg(r)(\deg(g)-\deg(r'))} b_0^{\deg(f)-\deg(r)} b_0'^{\deg(g)-\deg(r')} \text{Res}(r', r, x) \\ &= (-1)^{\deg(f)\deg(g)+\deg(g)\deg(r)} b_0^{\deg(f)-\deg(r)} b_0'^{\deg(g)-\deg(r')} \text{Res}(r, r', x) \end{aligned}$$

where  $b_0$  (resp.  $b_0'$ ) is the leading coefficient of  $g$  (resp.  $r$ ). Continuing in this way, we can reduce to the case where the second polynomial is constant, and then we can use Exercise 14 to compute the resultant.

To set this up as pseudocode, we need to introduce two functions: let  $r = \text{remainder}(f, g)$  be the remainder on division of  $f$  by  $g$  and let  $\text{lead}(f)$  be the leading coefficient of  $f$ . We can now state the algorithm for finding  $\text{Res}(f, g, x)$

```

Input:  $f, g$ 
Output:  $res$ 
 $h := f$ 
 $s := g$ 
 $res := 1$ 
WHILE  $\deg(s) > 0$  DO
     $r := \text{remainder}(h, s)$ 
     $res := (-1)^{\deg(h)\deg(s)} \text{lead}(s)^{\deg(h)-\deg(r)} res$ 
     $h := s$ 
     $s := r$ 
IF  $h = 0$  or  $s = 0$  THEN  $res := 0$  ELSE
IF  $\deg(h) > 0$  THEN  $res := s^{\deg(h)} res$ 

```

Prove that this algorithm computes the resultant of  $f$  and  $g$ . Hint: Use Exercises 14, 15, and 16, and follow the proof of Proposition 6 of Chapter 1, §5.

## §6 Resultants and the Extension Theorem

In this section we will prove the Extension Theorem using the results of §5. Our first task will be to adapt the theory of resultants to the case of polynomials in  $n$  variables. Thus, suppose we are given  $f, g \in k[x_1, \dots, x_n]$  of positive degree in  $x_1$ . As in §5, we write

$$(1) \quad \begin{aligned} f &= a_0 x_1^l + \dots + a_1, & a_0 &\neq 0, \\ g &= b_0 x_1^m + \dots + b_m, & b_0 &\neq 0, \end{aligned}$$

where  $a_i, b_i \in k[x_2, \dots, x_n]$ , and we define the *resultant* of  $f$  and  $g$  with respect to  $x_1$

to be the determinant

$$\text{Res}(f, g, x_1) = \det \left( \begin{array}{ccccccc} a_0 & & & & b_0 & & \\ a_1 & a_0 & & & b_1 & b_0 & \\ & a_1 & \ddots & & & b_1 & \ddots \\ \vdots & & \ddots & a_0 & \vdots & & \ddots & b_0 \\ & \vdots & & a_1 & & \vdots & & b_1 \\ a_l & & & & b_m & & & \\ & a_l & & \vdots & & b_m & & \vdots \\ & & \ddots & & & & \ddots & \\ & & & a_l & & & & b_m \end{array} \right),$$

where the empty spaces are filled by zeros.

For resultants of polynomials in several variables, the results of §5 can be stated as follows.

**Proposition 1.** *Let  $f, g \in k[x_1, \dots, x_n]$  have positive degree in  $x_1$ . Then:*

- (i)  $\text{Res}(f, g, x_1)$  is in the first elimination ideal  $\langle f, g \rangle \cap k[x_2, \dots, x_n]$ .
- (ii)  $\text{Res}(f, g, x_1) = 0$  if and only if  $f$  and  $g$  have a common factor in  $k[x_1, \dots, x_n]$  which has positive degree in  $x_1$ .

**Proof.** When we write  $f, g$  in terms of  $x_1$ , the coefficients  $a_i, b_i$ , lie in  $k[x_2, \dots, x_n]$ . Since the resultant is an integer polynomial in  $a_i, b_i$ , (Proposition 9 of §5), it follows that  $\text{Res}(f, g, x_1) \in k[x_2, \dots, x_n]$ . We also know that

$$Af + Bg = \text{Res}(f, g, x_1),$$

where  $A$  and  $B$  are polynomials in  $x_1$  whose coefficients are again integer polynomials in  $a_i, b_i$  (Proposition 9 of §5). Thus,  $A, B \in k[x_2, \dots, x_n][x_1] = k[x_1, \dots, x_n]$ , and then the above equation implies  $\text{Res}(f, g, x_1) \in \langle f, g \rangle$ . This proves part (i) of the proposition.

To prove the second part, we will use Proposition 8 of §5 to interpret the vanishing of the resultant in terms of common factors. In §5, we worked with polynomials in one variable with coefficients in a field. Since  $f$  and  $g$  are polynomials in  $x_1$  with coefficients in  $k[x_2, \dots, x_n]$  the field the coefficients lie in is  $k(x_2, \dots, x_n)$ . Then Proposition 8 of §5, applied to  $f, g \in k(x_2, \dots, x_n)[x_1]$ , tells us that  $\text{Res}(f, g, x_1) = 0$  if and only if  $f$  and  $g$  have a common factor in  $k(x_2, \dots, x_n)[x_1]$  which has positive degree in  $x_1$ . But then we can apply Corollary 4 of §5, which says that this is equivalent to having a common factor in  $k[x_1, \dots, x_n]$  of positive degree in  $x_1$ . The proposition is proved. □

Over the complex numbers, two polynomials in  $\mathbb{C}[x]$  have a common factor if and only if they have a common root (this is easy to prove). Thus, we get the following corollary of Proposition 1.

**Corollary 2.** *If  $f, g \in \mathbb{C}[x]$ , then  $\text{Res}(f, g, x) = 0$  if and only if  $f$  and  $g$  have a common root in  $\mathbb{C}$ .*

We will prove the Extension Theorem by studying the interaction between resultants and partial solutions. Given  $f, g \in \mathbb{C}[x_1, \dots, x_n]$ , we get the resultant

$$h = \text{Res}(f, g, x_1) \in \mathbb{C}[x_2, \dots, x_n]$$

as in Proposition 1. If we substitute  $\mathbf{c} = (c_2, \dots, c_n) \in \mathbb{C}^{n-1}$  into  $h$ , we get a *specialization* of the resultant. However, this need not equal the resultant of the specialized polynomials  $f(x_1, \mathbf{c})$  and  $g(x_1, \mathbf{c})$ . See Exercises 8 and 9 for some examples. Fortunately, there is one situation where the exact relation between these resultants is easy to state.

**Proposition 3.** *Let  $f, g \in \mathbb{C}[x_1, \dots, x_n]$  have degree  $l, m$  respectively, and let  $\mathbf{c} = (c_2, \dots, c_n) \in \mathbb{C}^{n-1}$  satisfy the following:*

- (i)  $f(x_1, \mathbf{c}) \in \mathbb{C}[x_1]$  has degree  $l$ .
- (ii)  $g(x_1, \mathbf{c}) \in \mathbb{C}[x_1]$  has degree  $p \leq m$ .

*Then the polynomial  $h = \text{Res}(f, g, x_1) \in \mathbb{C}[x_2, \dots, x_n]$  satisfies*

$$h(\mathbf{c}) = a_0(\mathbf{c})^{m-p} \text{Res}(f(x_1, \mathbf{c}), g(x_1, \mathbf{c}), x_1),$$

where  $a_0$  is as in (1).

**Proof.** If we substitute  $\mathbf{c} = (c_2, \dots, c_n)$  for  $x_2, \dots, x_n$  in the determinantal formula for  $h = \text{Res}(f, g, x_1)$ , we obtain

$$h(\mathbf{c}) = \det \left( \begin{array}{cccc} a_0(\mathbf{c}) & & & b_0(\mathbf{c}) \\ \vdots & \ddots & & \vdots \\ \vdots & & a_0(\mathbf{c}) & \vdots \\ a_l(\mathbf{c}) & & \vdots & b_m(\mathbf{c}) \\ & \ddots & \vdots & \vdots \\ & & a_l(\mathbf{c}) & b_m(\mathbf{c}) \end{array} \right).$$

$\underbrace{\hspace{10em}}_{m \text{ columns}}$ 
 $\underbrace{\hspace{10em}}_{l \text{ columns}}$

First suppose that  $g(x_1, \mathbf{c})$  has degree  $p = m$ . Then our assumptions imply that

$$\begin{aligned} f(x_1, \mathbf{c}) &= a_0(\mathbf{c})x_1^l + \dots + a_l(\mathbf{c}), & a_0(\mathbf{c}) \neq 0, \\ g(x_1, \mathbf{c}) &= b_0(\mathbf{c})x_1^m + \dots + b_m(\mathbf{c}), & b_0(\mathbf{c}) \neq 0. \end{aligned}$$

Hence the above determinant is the resultant of  $f(x_1, \mathbf{c})$  and  $g(x_1, \mathbf{c})$ , so that

$$h(\mathbf{c}) = \text{Res}(f(x_1, \mathbf{c}), g(x_1, \mathbf{c}), x_1).$$

This proves the proposition when  $p = m$ . When  $p < m$ , the above determinant is no longer the resultant of  $f(x_1, \mathbf{c})$  and  $g(x_1, \mathbf{c})$  (it has the wrong size). Here, we get the desired resultant by repeatedly expanding by minors along the first row. We leave the details to the reader (see Exercise 10). □

We can now prove the Extension Theorem. Let us recall the statement of the theorem.

**Theorem 4 (The Extension Theorem).** *Let  $I = \langle f_1, \dots, f_s \rangle \subset \mathbb{C}[x_1, \dots, x_n]$ , and let  $I_1$  be the first elimination ideal of  $I$ . For each  $1 \leq i \leq s$ , write  $f_i$  in the form*

$$f_i = g_i(x_2, \dots, x_n)x_1^{N_i} + \text{terms in which } x_1 \text{ has degree} < N_i,$$

where  $N_i \geq 0$  and  $g_i \in \mathbb{C}[x_2, \dots, x_n]$  is nonzero. Suppose that we have a partial solution  $(c_2, \dots, c_n) \in \mathbf{V}(I_1)$ . If  $(c_2, \dots, c_n) \notin \mathbf{V}(g_1, \dots, g_s)$ , then there exists  $c_1 \in \mathbb{C}$  such that  $(c_1, c_2, \dots, c_n) \in \mathbf{V}(I)$ .

**Proof.** As above, we set  $\mathbf{c} = (c_2, \dots, c_n)$ . Then consider the ring homomorphism

$$\mathbb{C}[x_1, \dots, x_n] \longrightarrow \mathbb{C}[x_1]$$

defined by  $f(x_1, x_2, \dots, x_n) \mapsto f(x_1, \mathbf{c})$ . In Exercise 11, you will show that the image of  $I$  under this homomorphism is an ideal of  $\mathbb{C}[x_1]$ . Since  $\mathbb{C}[x_1]$  is a PID, the image of  $I$  is generated by a single polynomial  $u(x_1)$ . In other words,

$$\{f(x_1, \mathbf{c}) : f \in I\} = \langle u(x_1) \rangle.$$

If  $u(x_1)$  is nonconstant, then there is  $c_1 \in \mathbb{C}$  such that  $u(c_1) = 0$  by the Fundamental Theorem of Algebra. It follows that  $f(c_1, \mathbf{c}) = 0$  for all  $f \in I$ , so that  $(c_1, \mathbf{c}) = (c_1, c_2, \dots, c_n) \in \mathbf{V}(I)$ . Note that this argument also works if  $u(x_1)$  is the zero polynomial.

It remains to consider what happens when  $u(x_1)$  is a nonzero constant  $u_0$ . By the above equality, there is  $f \in I$  such that  $f(x_1, \mathbf{c}) = u_0$ . We will show that this case cannot occur. By hypothesis, our partial solution satisfies  $\mathbf{c} \notin \mathbf{V}(g_1, \dots, g_s)$ . Hence  $g_i(\mathbf{c}) \neq 0$  for some  $i$ . Then consider

$$h = \text{Res}(f_i, f, x_1) \in \mathbb{C}[x_2, \dots, x_n].$$

Applying Proposition 3 to  $f_i$  and  $f$ , we obtain

$$h(\mathbf{c}) = g_i(\mathbf{c})^{\deg(f)} \text{Res}(f_i(x_1, \mathbf{c}), u_0, x_1)$$

since  $f(x_1, \mathbf{c}) = u_0$ . We also have  $\text{Res}(f_i(x_1, \mathbf{c}), u_0, x_1) = u_0^{N_i}$  by part (a) of Exercise 14 of §5. Hence

$$h(\mathbf{c}) = g_i(\mathbf{c})^{\deg(f)} u_0^{N_i} \neq 0.$$

However,  $f_i, f \in I$  and Proposition 1 imply that  $h \in I_1$ , so that  $h(\mathbf{c}) = 0$  since  $\mathbf{c} \in \mathbf{V}(I_1)$ . This contradiction completes the proof of the Extension Theorem.  $\square$

The proof of the Extension Theorem just given is elegant but nonconstructive, since it does not explain how to construct the polynomial  $u(x_1)$ . Exercise 12 will describe a constructive method for getting a polynomial whose root gives the desired  $c_1$ .

A final observation to make is that the Extension Theorem is true over any algebraically closed field. For concreteness, we stated the theorem only for the complex numbers  $\mathbb{C}$ , but if you examine the proof carefully, you will see that the required  $c_1$  exists because a nonconstant polynomial in  $\mathbb{C}[x_1]$  has a root in  $\mathbb{C}$ . Since this property is true for any algebraically closed field, it follows that the Extension Theorem holds over such fields (see Exercise 13 for more details).

## EXERCISES FOR §6

1. In  $k[x, y]$ , consider the two polynomials

$$\begin{aligned} f &= x^2y - 3xy^2 + x^2 - 3xy, \\ g &= x^3y + x^3 - 4y^2 - 3y + 1. \end{aligned}$$

- Compute  $\text{Res}(f, g, x)$ .
  - Compute  $\text{Res}(f, g, y)$ .
  - What does the result of part b imply about  $f$  and  $g$ ?
2. Let  $f, g \in \mathbb{C}[x, y]$  be nonzero. In this exercise, you will prove that

$$\mathbf{V}(f, g) \text{ is infinite} \iff f \text{ and } g \text{ have a nonconstant common factor in } \mathbb{C}[x, y].$$

- Prove that  $\mathbf{V}(f)$  is infinite when  $f$  is nonconstant. Hint: Suppose  $f$  has positive degree in  $x$ . Then the leading coefficient of  $x$  in  $f$  can vanish for at most finitely many values of  $y$ . Now use the fact that  $\mathbb{C}$  is algebraically closed.
  - If  $f$  and  $g$  have a nonconstant common factor  $h \in \mathbb{C}[x, y]$ , then use part a to show that  $\mathbf{V}(f, g)$  is infinite.
  - If  $f$  and  $g$  have no nonconstant common factor, show that  $\text{Res}(f, g, x)$  and  $\text{Res}(f, g, y)$  are nonzero and conclude that  $\mathbf{V}(f, g)$  is finite.
3. If  $f, g \in k[x, y]$ , Proposition 1 shows that  $\text{Res}(f, g, x) \in I_1 = \langle f, g \rangle \cap k[y]$ . The interesting fact is that the resultant *need not* generate  $I_1$ .
- Show that  $\text{Res}(f, g, x)$  generates  $I_1$  when  $f = xy - 1$  and  $g = x^2 + y^2 - 4$ .
  - Show that  $\text{Res}(f, g, x)$  does not generate  $I_1$  when  $f = xy - 1$  and  $g = yx^2 + y^2 - 4$ . Do you see any connection between part b and the Extension Theorem?
4. Suppose that  $f, g \in \mathbb{C}[x]$  are polynomials of positive degree. The goal of this problem is to construct a polynomial whose roots are all sums of a root of  $f$  plus a root of  $g$ .
- Show that a complex number  $\gamma \in \mathbb{C}$  can be written  $\gamma = \alpha + \beta$ , where  $f(\alpha) = g(\beta) = 0$ , if and only if the equations  $f(x) = g(y - x) = 0$  have a solution with  $y = \gamma$ .
  - Using Proposition 3, show that  $\gamma$  is a root of  $\text{Res}(f(x), g(y - x), x)$  if and only if  $\gamma = \alpha + \beta$ , where  $f(\alpha) = g(\beta) = 0$ .
  - Construct a polynomial with coefficients in  $\mathbb{Q}$  which has  $\sqrt{2} + \sqrt{3}$  as a root. Hint: What are  $f$  and  $g$  in this case?
  - Modify your construction to create a polynomial whose roots are all differences of a root of  $f$  minus a root of  $g$ .
5. Suppose that  $f, g \in \mathbb{C}[x]$  are polynomials of positive degree. If all of the roots of  $f$  are nonzero, adapt the argument of Exercise 4 to construct a polynomial whose roots are all products of a root of  $f$  times a root of  $g$ .
6. Suppose that  $f, g \in \mathbb{Q}[x]$  are polynomials of positive degree.
- Most computer algebra systems have a command for factoring polynomials over  $\mathbb{Q}$  into irreducibles over  $\mathbb{Q}$ . In particular, one can determine if a given polynomial has any integer roots. Combine this with part (d) of Exercise 4 to describe an algorithm for determining when  $f$  and  $g$  have roots  $\alpha$  and  $\beta$ , respectively, which differ by an integer.
  - Show that the polynomials  $f = x^5 - 2x^3 - 2x^2 + 4$  and  $g = x^5 + 5x^4 + 8x^3 + 2x^2 - 5x + 1$  have roots which differ by an integer. What is the integer?
7. In §3, we mentioned that resultants are sometimes used to solve implicitization problems. For a simple example of how this works, consider the curve parametrized by

$$u = \frac{t^2}{1+t^2}, \quad v = \frac{t^3}{1+t^2}.$$

To get an implicit equation, form the equations

$$u(1 + t^2) - t^2 = 0, \quad v(1 + t^2) - t^3 = 0$$

and use an appropriate resultant to eliminate  $t$ . Then compare your result to the answer obtained by the methods of §3. (Note that Exercise 13 of §3 is relevant.)

8. In the discussion leading up to Proposition 3, we claimed that the specialization of a resultant need not be the resultant of the specialized polynomials. Let us work out some examples.

a. Let  $f = x^2y + 3x - 1$  and  $g = 6x^2 + y^2 - 4$ . Compute  $h = \text{Res}(f, g, x)$  and show that  $h(0) = -180$ . But if we set  $y = 0$  in  $f$  and  $g$ , we get the polynomials  $3x - 1$  and  $6x^2 - 4$ . Check that  $\text{Res}(3x - 1, 6x^2 - 4) = -30$ . Thus,  $h(0)$  is *not* a resultant—it is off by a factor of 6. Note why equality fails:  $h(0)$  is a  $4 \times 4$  determinant, whereas  $\text{Res}(3x - 1, 6x^2 - 4)$  is a  $3 \times 3$  determinant.

b. Now let  $f = x^2y + 3xy - 1$  and  $g = 6x^2 + y^2 - 4$ . Compute  $h = \text{Res}(f, g, x)$  and verify that  $h(0) = 36$ . Setting  $y = 0$  in  $f$  and  $g$  gives polynomials  $-1$  and  $6x^2 - 4$ . Use Exercise 14 of §5 to show that the resultant of these polynomials is 1. Thus,  $h(0)$  is off by a factor of 36.

When the degree of  $f$  drops by 1 (in part a), we get an extra factor of 6, and when it drops by 2 (in part b), we get an extra factor of  $36 = 6^2$ . And the leading coefficient of  $x$  in  $g$  is 6. In Exercise 10, we will see that this is no accident.

9. Let  $f = x^2y + x - 1$  and  $g = x^2y + x + y^2 - 4$ . If  $h = \text{Res}(f, g, x) \in \mathbb{C}[y]$ , show that  $h(0) = 0$ . But if we substitute  $y = 0$  into  $f$  and  $g$ , we get  $x - 1$  and  $x - 4$ . Show that these polynomials have a nonzero resultant. Thus,  $h(0)$  is *not* a resultant.

10. In this problem you will complete the proof of Theorem 4 by determining what happens to a resultant when specializing causes the degree of one of the polynomials to drop. Let  $f, g \in \mathbb{C}[x_1, \dots, x_n]$  and set  $h = \text{Res}(f, g, x_1)$ . If  $\mathbf{c} = (c_2, \dots, c_n) \in \mathbb{C}^{n-1}$ , let  $f(x_1, \mathbf{c})$  be the polynomial in  $k[x_1]$  obtained by substituting in  $\mathbf{c}$ . As in (1), let  $a_0, b_0 \in \mathbb{C}[x_2, \dots, x_n]$  be the leading coefficients of  $x_1$  in  $f, g$ , respectively. We will assume that  $a_0(\mathbf{c}) \neq 0$  and  $b_0(\mathbf{c}) = 0$ , and our goal is to see how  $h(\mathbf{c})$  relates to  $\text{Res}(f(x_1, \mathbf{c}), g(x_1, \mathbf{c}), x_1)$ .

a. First suppose that the degree of  $g$  drops by exactly 1, which means that  $b_1(\mathbf{c}) \neq 0$ . In this case, prove that

$$h(\mathbf{c}) = a_0(\mathbf{c}) \cdot \text{Res}(f(x_1, \mathbf{c}), g(x_1, \mathbf{c}), x_1).$$

Hint:  $h(\mathbf{c})$  is given by the following determinant:

$$h(\mathbf{c}) = \det \left( \begin{array}{cccc} a_0(\mathbf{c}) & & & 0 \\ a_1(\mathbf{c}) & a_0(\mathbf{c}) & & b_1(\mathbf{c}) \quad 0 \\ & a_1(\mathbf{c}) & \ddots & b_1(\mathbf{c}) \quad \ddots \\ \vdots & & \ddots & a_0(\mathbf{c}) \quad \vdots \quad \ddots \quad 0 \\ & \ddots & & a_1(\mathbf{c}) & & \vdots & b_1(\mathbf{c}) \\ a_l(\mathbf{c}) & & & & b_m(\mathbf{c}) & & \\ & a_l(\mathbf{c}) & & \vdots & & b_m(\mathbf{c}) & \vdots \\ & & \ddots & & & & \ddots \\ & & & a_l(\mathbf{c}) & & & b_m(\mathbf{c}) \end{array} \right).$$

$\underbrace{\hspace{15em}}_{m \text{ columns}}$ 
 $\underbrace{\hspace{15em}}_{l \text{ columns}}$



The determinant is the wrong size to be the resultant of  $f(x_1, \mathbf{c})$  and  $g(x_1, \mathbf{c})$ . If you expand by minors along the first row [see Theorem 5.7 of FINKBEINER (1978)], the desired result will follow.

- b. Now let us do the general case. Suppose that the degree of  $g(x_1, \mathbf{c})$  is  $m - p$ , where  $p \geq 1$ . Then prove that

$$h(\mathbf{c}) = a_0(\mathbf{c})^p \cdot \text{Res}(f(x_1, \mathbf{c}), g(x_1, \mathbf{c}), x_1).$$

Hint: Expand by minors  $p$  times. Note how this formula explains the results of Exercise 8.

11. Suppose that  $k$  is a field and  $\varphi : k[x_1, \dots, x_n] \rightarrow k[x_1]$  is a ring homomorphism that is the identity on  $k$  and maps  $x_i$  to  $x_1$ . Given an ideal  $I \subset k[x_1, \dots, x_n]$ , prove that  $\varphi(I) \subset k[x_1]$  is an ideal. (In the proof of Theorem 4, we use this result when  $\varphi$  is the map that evaluates  $x_i$  at  $c_i$  for  $2 \leq i \leq n$ .)
12. Suppose that  $I = \langle f_1, \dots, f_s \rangle \subset \mathbb{C}[x_1, \dots, x_n]$  and  $\mathbf{c} = (c_2, \dots, c_s) \in \mathbf{V}(I_1)$  satisfy the hypotheses of Theorem 4. To get the desired  $c_1 \in \mathbb{C}$ , the proof of Theorem 4 given in the text uses a polynomial  $u(x_1)$  found by nonconstructive means. But now that we know the theorem is true, we can give a constructive method for finding  $c_1$  by considering the polynomial

$$v(x_1) = \text{GCD}(f_1(x_1, \mathbf{c}), \dots, f_s(x_1, \mathbf{c})).$$

- (a) Show that  $v(x_1)$  is nonconstant and that every root  $c_1$  of  $v(x_1)$  satisfies the conclusion of the Theorem 4. Hint: Show that  $u(x_1)$  divides  $v(x_1)$ .
- (b) Show that  $v(x_1)$  and  $u(x_1)$  have the same roots. Hint: Express  $u(x_1)$  in terms of the  $f_i(x, \mathbf{c})$ .
13. Show that the Extension Theorem holds over any algebraically closed field. Hint: You will need to see exactly where the proof of Theorem 4 uses the complex numbers  $\mathbb{C}$ .

# 4

## The Algebra–Geometry Dictionary

In this chapter, we will explore the correspondence between ideals and varieties. In §§1 and 2, we will prove the Nullstellensatz, a celebrated theorem which identifies exactly which ideals correspond to varieties. This will allow us to construct a “dictionary” between geometry and algebra, whereby any statement about varieties can be translated into a statement about ideals (and conversely). We will pursue this theme in §§3 and 4, where we will define a number of natural algebraic operations on ideals and study their geometric analogues. In keeping with the computational emphasis of this course, we will develop algorithms to carry out the algebraic operations. In §§5 and 6, we will study the more important algebraic and geometric concepts arising out of the Hilbert Basis Theorem: notably the possibility of decomposing a variety into a union of simpler varieties and the corresponding algebraic notion of writing an ideal as an intersection of simpler ideals.

### §1 Hilbert’s Nullstellensatz

In Chapter 1, we saw that a variety  $V \subset k^n$  can be studied by passing to the ideal

$$\mathbf{I}(V) = \{f \in k[x_1, \dots, x_n] : f(x) = 0 \text{ for all } x \in V\}$$

of all polynomials vanishing on  $V$ . That is, we have a map

$$\begin{array}{ccc} \text{affine varieties} & & \text{ideals} \\ V & \longrightarrow & \mathbf{I}(V). \end{array}$$

Conversely, given an ideal  $I \subset k[x_1, \dots, x_n]$ , we can define the set

$$\mathbf{V}(I) = \{x \in k^n : f(x) = 0 \text{ for all } f \in I\}.$$

The Hilbert Basis Theorem assures us that  $\mathbf{V}(I)$  is actually an affine variety, for it tells us that there exists a finite set of polynomials  $f_1, \dots, f_s \in I$  such that  $I = \langle f_1, \dots, f_s \rangle$ ,

and we proved in Proposition 9 of Chapter 2, §5 that  $\mathbf{V}(I)$  is the set of common roots of these polynomials. Thus, we have a map

$$\begin{array}{ccc} \text{ideals} & \longrightarrow & \text{affine varieties} \\ I & & \mathbf{V}(I). \end{array}$$

These two maps give us a correspondence between ideals and varieties. In this chapter, we will explore the nature of this correspondence.

The first thing to note is that this correspondence (more precisely, the map  $\mathbf{V}$ ) is not one-to-one: different ideals can give the same variety. For example,  $\langle x \rangle$  and  $\langle x^2 \rangle$  are different ideals in  $k[x]$  which have the same variety  $\mathbf{V}(x) = \mathbf{V}(x^2) = \{0\}$ . More serious problems can arise if the field  $k$  is not algebraically closed. For example, consider the three polynomials  $1$ ,  $1 + x^2$ , and  $1 + x^2 + x^4$  in  $\mathbb{R}[x]$ . These generate different ideals

$$I_1 = \langle 1 \rangle = \mathbb{R}[x], \quad I_2 = \langle 1 + x^2 \rangle, \quad I_3 = \langle 1 + x^2 + x^4 \rangle,$$

but each polynomial has no real roots, so that the corresponding varieties are all empty:

$$\mathbf{V}(I_1) = \mathbf{V}(I_2) = \mathbf{V}(I_3) = \emptyset.$$

Examples of polynomials in two variables without real roots include  $1 + x^2 + y^2$  and  $1 + x^2 + y^4$ . These give different ideals in  $\mathbb{R}[x, y]$  which correspond to the empty variety.

Does this problem of having different ideals represent the empty variety go away if the field  $k$  is algebraically closed? It does in the one-variable case when the ring is  $k[x]$ . To see this, recall from §5 of Chapter 1 that any ideal  $I$  in  $k[x]$  can be generated by a single polynomial because  $k[x]$  is a principal ideal domain. So we can write  $I = \langle f \rangle$  for some polynomial  $f \in k[x]$ . Then  $\mathbf{V}(I)$  is the set of roots of  $f$ ; that is, the set of  $a \in k$  such that  $f(a) = 0$ . But since  $k$  is algebraically closed, every nonconstant polynomial in  $k[x]$  has a root. Hence, the only way that we could have  $\mathbf{V}(I) = \emptyset$  would be to have  $f$  be a nonzero constant. In this case,  $1/f \in k$ . Thus,  $1 = (1/f) \cdot f \in I$ , which means that  $g = g \cdot 1 \in I$  for all  $g \in k[x]$ . This shows that  $I = k[x]$  is the only ideal of  $k[x]$  that represents the empty variety when  $k$  is algebraically closed.

A wonderful thing now happens: the same property holds when there is more than one variable. In any polynomial ring, algebraic closure is enough to guarantee that the only ideal which represents the empty variety is the entire polynomial ring itself. This is the *Weak Nullstellensatz*, which is the basis of (and is equivalent to) one of the most celebrated mathematical results of the late nineteenth century, Hilbert's Nullstellensatz. Such is its impact that, even today, one customarily uses the original German name *Nullstellensatz*: a word formed, in typical German fashion, from three simpler words: Null (=Zero), Stellen (=Places), Satz (=Theorem).

**Theorem 1 (The Weak Nullstellensatz).** *Let  $k$  be an algebraically closed field and let  $I \subset k[x_1, \dots, x_n]$  be an ideal satisfying  $\mathbf{V}(I) = \emptyset$ . Then  $I = k[x_1, \dots, x_n]$ .*

**Proof.** To prove that an ideal  $I$  equals  $k[x_1, \dots, x_n]$ , the standard strategy is to show that the constant polynomial  $1$  is in  $I$ . This is because if  $1 \in I$ , then by the definition of an ideal, we have  $f = f \cdot 1 \in I$  for every  $f \in k[x_1, \dots, x_n]$ . Thus, knowing that  $1 \in I$  is enough to show that  $I$  is the whole polynomial ring.

Our proof is by induction on  $n$ , the number of variables. If  $n = 1$  and  $I \subset k[x]$  satisfies  $\mathbf{V}(I) = \emptyset$ , then we already showed that  $I = k[x]$  in the discussion preceding the statement of the theorem.

Now assume the result has been proved for the polynomial ring in  $n - 1$  variables, which we write as  $k[x_2, \dots, x_n]$ . Consider any ideal  $I = \langle f_1, \dots, f_s \rangle \subset k[x_1, \dots, x_n]$  for which  $\mathbf{V}(I) = \emptyset$ . We may assume that  $f_1$  is not a constant since, otherwise, there is nothing to prove. So, suppose  $f_1$  has total degree  $N \geq 1$ . We will next change coordinates so that  $f_1$  has an especially nice form. Namely, consider the linear change of coordinates

$$(1) \quad \begin{aligned} x_1 &= \tilde{x}_1, \\ x_2 &= \tilde{x}_2 + a_2 \tilde{x}_1, \\ &\vdots \\ x_n &= \tilde{x}_n + a_n \tilde{x}_1. \end{aligned}$$

where the  $a_i$  are as-yet-to-be-determined constants in  $k$ . Substitute for  $x_1, \dots, x_n$  so that  $f_1$  has the form

$$\begin{aligned} f_1(x_1, \dots, x_n) &= f_1(\tilde{x}_1, \tilde{x}_2 + a_2 \tilde{x}_1, \dots, \tilde{x}_n + a_n \tilde{x}_1) \\ &= c(a_2, \dots, a_n) \tilde{x}_1^N + \text{terms in which } \tilde{x}_1 \text{ has degree} < N. \end{aligned}$$

We will leave it as an exercise for the reader to show that  $c(a_2, \dots, a_n)$  is a nonzero polynomial expression in  $a_2, \dots, a_n$ . In the exercises, you will also show that an algebraically closed field is infinite. Thus we can choose  $a_2, \dots, a_n$  so that  $c(a_2, \dots, a_n) \neq 0$  by Proposition 5 of Chapter 1, §1.

With this choice of  $a_2, \dots, a_n$ , under the coordinate change (1) every polynomial  $f \in k[x_1, \dots, x_n]$  goes over to a polynomial  $\tilde{f} \in k[\tilde{x}_1, \dots, \tilde{x}_n]$ . In the exercises, we will ask you to check that the set  $\tilde{I} = \{\tilde{f} : f \in I\}$  is an ideal in  $k[\tilde{x}_1, \dots, \tilde{x}_n]$ . Note that we still have  $\mathbf{V}(\tilde{I}) = \emptyset$  since if the transformed equations had solutions, so would the original ones. Furthermore, if we can show that  $1 \in \tilde{I}$ , then  $1 \in I$  will follow since constants are unaffected by the  $\sim$  operation.

Hence, it suffices to prove that  $1 \in \tilde{I}$ . By the previous paragraph,  $f_1 \in I$  transforms to  $\tilde{f}_1 \in \tilde{I}$  with the property that

$$\tilde{f}_1(\tilde{x}_1, \dots, \tilde{x}_n) = c(a_2, \dots, a_n) \tilde{x}_1^N + \text{terms in which } \tilde{x}_1 \text{ has degree} < N,$$

where  $c(a_2, \dots, a_n) \neq 0$ . This allows us to use a corollary of the Geometric Extension Theorem (see Corollary 4 of Chapter 3, §2), to relate  $\mathbf{V}(\tilde{I})$  with its projection into the subspace of  $k^n$  with coordinates  $\tilde{x}_2, \dots, \tilde{x}_n$ . As we noted in Chapter 3, the Extension Theorem and its corollaries hold over any algebraically closed field. Let

$$\pi_1 : k^n \rightarrow k^{n-1}$$

be the projection mapping onto the last  $n - 1$  components. If we set  $\tilde{I}_1 = \tilde{I} \cap k[\tilde{x}_2, \dots, \tilde{x}_n]$  as usual, then the corollary states that partial solutions in  $k^{n-1}$  always extend, i.e.,  $\mathbf{V}(\tilde{I}_1) = \pi_1(\mathbf{V}(\tilde{I}))$ . This implies that  $\mathbf{V}(\tilde{I}_1) = \pi_1(\mathbf{V}(\tilde{I})) = \pi_1(\emptyset) = \emptyset$ .

By the induction hypothesis, it follows that  $\tilde{I}_1 = k[\tilde{x}_2, \dots, \tilde{x}_n]$ . But this implies that  $1 \in \tilde{I}_1 \subset \tilde{I}$ , and the proof is complete.  $\square$

In the special case when  $k = \mathbb{C}$ , the Weak Nullstellensatz may be thought of as the “Fundamental Theorem of Algebra for multivariable polynomials”—every system of polynomials that generates an ideal strictly smaller than  $\mathbb{C}[x_1, \dots, x_n]$  has a common zero in  $\mathbb{C}^n$ .

The Weak Nullstellensatz also allows us to solve the *consistency problem* from §2 of Chapter 1. Recall that this problem asks whether a system

$$\begin{aligned} f_1 &= 0, \\ f_2 &= 0, \\ &\vdots \\ f_s &= 0 \end{aligned}$$

of polynomial equations has a common solution in  $\mathbb{C}^n$ . The polynomials fail to have a common solution if and only if  $\mathbf{V}(f_1, \dots, f_s) = \emptyset$ . By the Weak Nullstellensatz, the latter holds if and only if  $1 \in \langle f_1, \dots, f_s \rangle$ . Thus, to solve the consistency problem, we need to be able to determine whether 1 belongs to an ideal. This is made easy by the observation that for any monomial ordering,  $\{1\}$  is the only reduced Groebner basis for the ideal  $\langle 1 \rangle$ .

To see this, let  $\{g_1, \dots, g_r\}$  be a Groebner basis of  $I = \langle 1 \rangle$ . Thus,  $1 \in \langle \text{LT}(I) \rangle = \langle \text{LT}(g_1), \dots, \text{LT}(g_r) \rangle$ , and then Lemma 2 of Chapter 2, §4 implies that 1 is divisible by some  $\text{LT}(g_i)$ , say  $\text{LT}(g_1)$ . This forces  $\text{LT}(g_1)$  to be constant. Then every other  $\text{LT}(g_i)$  is a multiple of that constant, so that  $g_2, \dots, g_r$  can be removed from the Groebner basis by Lemma 3 of Chapter 2, §7. Finally, since  $\text{LT}(g_1)$  is constant,  $g_1$  itself is constant since every nonconstant monomial is  $> 1$  (see Corollary 6 of Chapter 2, §4). We can multiply by an appropriate constant to make  $g_1 = 1$ . Our reduced Groebner basis is thus  $\{1\}$ .

To summarize, we have the following **consistency algorithm**: if we have polynomials  $f_1, \dots, f_s \in \mathbb{C}[x_1, \dots, x_n]$ , we compute a reduced Groebner basis of the ideal they generate with respect to any ordering. If this basis is  $\{1\}$ , the polynomials have no common zero in  $\mathbb{C}^n$ ; if the basis is not  $\{1\}$ , they must have a common zero. Note that the algorithm works over any algebraically closed field.

If we are working over a field  $k$  which is not algebraically closed, then the consistency algorithm still works in one direction: if  $\{1\}$  is a reduced Groebner basis of  $\langle f_1, \dots, f_s \rangle$ , then the equations  $f_1 = \dots = f_s = 0$  have no common solution. The converse is not true, as shown by the examples preceding the statement of the Weak Nullstellensatz.

Inspired by the Weak Nullstellensatz, one might hope that the correspondence between ideals and varieties is one-to-one provided only that one restricts to algebraically closed fields. Unfortunately, our earlier example  $\mathbf{V}(x) = \mathbf{V}(x^2) = \{0\}$  works over *any* field. Similarly, the ideals  $\langle x^2, y \rangle$  and  $\langle x, y \rangle$  (and, for that matter,  $\langle x^n, y^m \rangle$  where  $n$  and  $m$  are integers greater than one) are different but define the same variety: namely, the single point  $\{(0, 0)\} \subset k^2$ . These examples illustrate a basic reason why different ideals

can define the same variety (equivalently, that the map  $\mathbf{V}$  can fail to be one-to-one): namely, a power of a polynomial vanishes on the same set as the original polynomial. The Hilbert Nullstellensatz states that over an algebraically closed field, this is the *only* reason that different ideals can give the same variety: if a polynomial  $f$  vanishes at all points of some variety  $\mathbf{V}(I)$ , then some power of  $f$  must belong to  $I$ .

**Theorem 2 (Hilbert's Nullstellensatz).** *Let  $k$  be an algebraically closed field. If  $f, f_1, \dots, f_s \in k[x_1, \dots, x_n]$  are such that  $f \in \mathbf{I}(\mathbf{V}(f_1, \dots, f_s))$ , then there exists an integer  $m \geq 1$  such that*

$$f^m \in \langle f_1, \dots, f_s \rangle$$

(and conversely).

**Proof.** Given a nonzero polynomial  $f$  which vanishes at every common zero of the polynomials  $f_1, \dots, f_s$ , we must show that there exists an integer  $m \geq 1$  and polynomials  $A_1, \dots, A_s$  such that

$$f^m = \sum_{i=1}^s A_i f_i.$$

The most direct proof is based on an ingenious trick. Consider the ideal

$$\tilde{I} = \langle f_1, \dots, f_s, 1 - yf \rangle \subset k[x_1, \dots, x_n, y],$$

where  $f, f_1, \dots, f_s$  are as above. We claim that

$$\mathbf{V}(\tilde{I}) = \emptyset.$$

To see this, let  $(a_1, \dots, a_n, a_{n+1}) \in k^{n+1}$ . Either

- $(a_1, \dots, a_n)$  is a common zero of  $f_1, \dots, f_s$ , or
- $(a_1, \dots, a_n)$  is not a common zero of  $f_1, \dots, f_s$ .

In the first case  $f(a_1, \dots, a_n) = 0$  since  $f$  vanishes at any common zero of  $f_1, \dots, f_s$ . Thus, the polynomial  $1 - yf$  takes the value  $1 - a_{n+1}f(a_1, \dots, a_n) = 1 \neq 0$  at the point  $(a_1, \dots, a_n, a_{n+1})$ . In particular,  $(a_1, \dots, a_n, a_{n+1}) \notin \mathbf{V}(\tilde{I})$ . In the second case, for some  $i, 1 \leq i \leq s$ , we must have  $f_i(a_1, \dots, a_n) \neq 0$ . Thinking of  $f_i$  as a function of  $n + 1$  variables which does not depend on the last variable, we have  $f_i(a_1, \dots, a_n, a_{n+1}) \neq 0$ . In particular, we again conclude that  $(a_1, \dots, a_n, a_{n+1}) \notin \mathbf{V}(\tilde{I})$ . Since  $(a_1, \dots, a_n, a_{n+1}) \in k^{n+1}$  was arbitrary, we conclude that  $\mathbf{V}(\tilde{I}) = \emptyset$  as claimed.

Now apply the Weak Nullstellensatz to conclude that  $1 \in \tilde{I}$ . That is,

$$(2) \quad 1 = \sum_{i=1}^s p_i(x_1, \dots, x_n, y) f_i + q(x_1, \dots, x_n, y)(1 - yf)$$

for some polynomials  $p_i, q \in k[x_1, \dots, x_n, y]$ . Now set  $y = 1/f(x_1, \dots, x_n)$ . Then relation (2) above implies that

$$(3) \quad 1 = \sum_{i=1}^s p_i(x_1, \dots, x_n, 1/f) f_i.$$

Multiply both sides of this equation by a power  $f^m$ , where  $m$  is chosen sufficiently large to clear all the denominators. This yields

$$(4) \quad f^m = \sum_{i=1}^s A_i f_i,$$

for some polynomials  $A_i \in k[x_1, \dots, x_n]$ , which is what we had to show.  $\square$

### EXERCISES FOR §1

- Recall that  $\mathbf{V}(y - x^2, z - x^3)$  is the twisted cubic in  $\mathbb{R}^3$ .
  - Show that  $\mathbf{V}((y - x^2)^2 + (z - x^3)^2)$  is also the twisted cubic.
  - Show that any variety  $\mathbf{V}(I) \subset \mathbb{R}^n$ ,  $I \subset \mathbb{R}[x_1, \dots, x_n]$ , can be defined by a single equation (and hence by a principal ideal).
- Let  $J = \langle x^2 + y^2 - 1, y - 1 \rangle$ . Find  $f \in \mathbf{I}(\mathbf{V}(J))$  such that  $f \notin J$ .
- Under the change of coordinates (1), a polynomial  $f(x_1, \dots, x_n)$  of total degree  $N$  goes over into a polynomial of the form

$$\tilde{f} = c(a_2, \dots, a_n) \tilde{x}_1^N + \text{terms in which } \tilde{x}_1 \text{ has degree} < N.$$

We want to show that  $c(a_2, \dots, a_n)$  is a nonzero polynomial in  $a_2, \dots, a_n$ .

- Write  $f = h_N + h_{N-1} + \dots + h_0$  where each  $h_i$ ,  $0 \leq i \leq N$ , is homogeneous of degree  $i$  (that is, where each monomial in  $h_i$  has total degree  $i$ ). Show that after the coordinate change (1), the coefficient  $c(a_2, \dots, a_n)$  of  $\tilde{x}_1^N$  in  $\tilde{f}$  is  $h_N(1, a_2, \dots, a_n)$ .
  - Let  $h(x_1, \dots, x_n)$  be a homogeneous polynomial. Show that  $h$  is the zero polynomial in  $k[x_1, \dots, x_n]$  if and only if  $h(1, x_2, \dots, x_n)$  is the zero polynomial in  $k[x_2, \dots, x_n]$ .
  - Conclude that  $c(a_2, \dots, a_n)$  is not the zero polynomial in  $a_2, \dots, a_n$ .
- Prove that an algebraically closed field  $k$  must be infinite. Hint: Given  $n$  elements  $a_1, \dots, a_n$  of a field  $k$ , can you write down a nonconstant polynomial  $f \in k[x]$  with the property that  $f(a_i) = 1$  for all  $i$ ?
  - Establish that  $\tilde{I}$  as defined in the proof of the Weak Nullstellensatz is an ideal of  $k[\tilde{x}_1, \dots, \tilde{x}_n]$ .
  - In deducing Hilbert's Nullstellensatz from the Weak Nullstellensatz, we made the substitution  $y = 1/f(x_1, \dots, x_n)$  to deduce relations (3) and (4) from (2). Justify this rigorously. Hint: In what set is  $1/f$  contained?
  - The purpose of this exercise is to show that if  $k$  is any field which is not algebraically closed, then any variety  $V \subset k^n$  can be defined by a single equation.
    - If  $f = a_0x^n + a_1x^{n-1} + \dots + a_{n-1}x + a_n$  is a polynomial of degree  $n$  in  $x$ , define the *homogenization*  $f^h$  of  $f$  with respect to some variable  $y$  to be the homogeneous polynomial  $f^h = a_0x^n + a_1x^{n-1}y + \dots + a_{n-1}xy^{n-1} + a_ny^n$ . Show that  $f$  has a root in  $k$  if and only if there is  $(a, b) \in k^2$  such that  $(a, b) \neq (0, 0)$  and  $f^h(a, b) = 0$ . Hint: Show that  $f^h(a, b) = b^n f^h(a/b, 1)$  when  $b \neq 0$ .
    - If  $k$  is not algebraically closed, show that there exists  $f \in k[x, y]$  such that the variety defined by  $f = 0$  consists of just the origin  $(0, 0) \in k^2$ . Hint: Choose a polynomial in  $k[x]$  with no root in  $k$  and consider its homogenization.
    - If  $k$  is not algebraically closed, show that for each integer  $s > 0$  there exists  $f \in k[x_1, \dots, x_s]$  such that the only solution of  $f = 0$  is the origin  $(0, \dots, 0) \in k^s$ . Hint: Use induction and part (b) above. See also Exercise 1.
    - If  $W = \mathbf{V}(g_1, \dots, g_s)$  is any variety in  $k^n$ , where  $k$  is not algebraically closed, then show that  $W$  can be defined by a single equation. Hint: Consider the polynomial  $f(g_1, \dots, g_s)$  where  $f$  is as above.

8. Let  $k$  be an arbitrary field and let  $S$  be the subset of all polynomials in  $k[x_1, \dots, x_n]$  that have no zeros in  $k^n$ . If  $I$  is any ideal in  $k[x_1, \dots, x_n]$  such that  $I \cap S = \emptyset$ , show that  $V(I) \neq \emptyset$ . Hint: When  $k$  is not algebraically closed, use the previous exercise.
9. (A generalization of Exercise 5.) Let  $A$  be an  $n \times n$  matrix with entries in  $k$ . Suppose that  $x = A\tilde{x}$  where we are thinking of  $x$  and  $\tilde{x}$  as column vectors. Define a map

$$\alpha_A : k[x_1, \dots, x_n] \longrightarrow k[\tilde{x}_1, \dots, \tilde{x}_n]$$

by sending  $f \in k[x_1, \dots, x_n]$  to  $\tilde{f} \in k[\tilde{x}_1, \dots, \tilde{x}_n]$ , where  $\tilde{f}$  is the polynomial defined by  $\tilde{f}(\tilde{x}) = f(A\tilde{x})$ .

- Show that  $\alpha_A$  is  $k$ -linear, i.e., show that  $\alpha_A(rf + sg) = r\alpha_A(f) + s\alpha_A(g)$  for all  $r, s \in k$  and all  $f, g \in k[x_1, \dots, x_n]$ .
  - Show that  $\alpha_A(f \cdot g) = \alpha_A(f) \cdot \alpha_A(g)$  for all  $f, g \in k[x_1, \dots, x_n]$ . [As we will see in Definition 8 of Chapter 5, §2, a map between rings which preserves addition and multiplication and also preserves the multiplicative identity is called a *ring homomorphism*. Since it is clear that  $\alpha_A(1) = 1$ , this shows that  $\alpha_A$  is a ring homomorphism.]
  - Find conditions on the matrix  $A$  which guarantee that  $\alpha_A$  is one-to-one and onto.
  - Is the image  $\{\alpha_A(f) : f \in I\}$  of an ideal  $I \subset k[x_1, \dots, x_n]$  necessarily an ideal in  $k[\tilde{x}_1, \dots, \tilde{x}_n]$ ? Give a proof or a counterexample.
  - Is the inverse image  $\{f \in k[x_1, \dots, x_n] : \alpha_A(f) \in \tilde{I}\}$  of an ideal  $\tilde{I}$  in  $k[\tilde{x}_1, \dots, \tilde{x}_n]$  an ideal in  $k[x_1, \dots, x_n]$ ? Give a proof or a counterexample.
  - Do the conclusions of parts a–e change if we allow the entries in the  $n \times n$  matrix  $A$  to be elements of  $k[\tilde{x}_1, \dots, \tilde{x}_n]$ ?
10. In Exercise 1, we encountered two ideals in  $\mathbb{R}[x, y]$  which give the same nonempty variety. Show that one of these ideals is contained in the other. Can you find two ideals in  $\mathbb{R}[x, y]$ , neither contained in the other, which give the same nonempty variety? Can you do the same for  $\mathbb{R}[x]$ ?

## §2 Radical Ideals and the Ideal–Variety Correspondence

To further explore the relation between ideals and varieties, it is natural to recast Hilbert’s Nullstellensatz in terms of ideals. Can we characterize the kinds of ideals that appear as the ideal of a variety? That is, can we identify those ideals that consist of *all* polynomials which vanish on some variety  $V$ ? The key observation is contained in the following simple lemma.

**Lemma 1.** *Let  $V$  be a variety. If  $f^m \in \mathbf{I}(V)$ , then  $f \in \mathbf{I}(V)$ .*

**Proof.** Let  $x \in V$ . If  $f^m \in \mathbf{I}(V)$ , then  $(f(x))^m = 0$ . But this can happen only if  $f(x) = 0$ . Since  $x \in V$  was arbitrary, we must have  $f \in \mathbf{I}(V)$ .  $\square$

Thus, an ideal consisting of *all* polynomials which vanish on a variety  $V$  has the property that if some power of a polynomial belongs to the ideal, then the polynomial itself must belong to the ideal. This leads to the following definition.

**Definition 2.** *An ideal  $I$  is radical if  $f^m \in I$  for some integer  $m \geq 1$  implies that  $f \in I$ .*

Rephrasing Lemma 1 in terms of radical ideals gives the following statement.



**Corollary 3.**  $\mathbf{I}(V)$  is a radical ideal.

On the other hand, Hilbert’s Nullstellensatz tells us that the only way that an arbitrary ideal  $I$  can fail to be the ideal of all polynomials vanishing on  $\mathbf{V}(I)$  is for  $I$  to contain powers  $f^m$  of polynomials  $f$  which are not in  $I$ —in other words, for  $I$  to fail to be a radical ideal. This suggests that there is a one-to-one correspondence between affine varieties and radical ideals. To clarify this and get a sharp statement, it is useful to introduce the operation of taking the radical of an ideal.

**Definition 4.** Let  $I \subset k[x_1, \dots, x_n]$  be an ideal. The **radical** of  $I$ , denoted  $\sqrt{I}$ , is the set

$$\{f : f^m \in I \text{ for some integer } m \geq 1\}.$$

Note that we always have  $I \subset \sqrt{I}$  since  $f \in I$  implies  $f^1 \in I$  and, hence,  $f \in \sqrt{I}$  by definition. It is an easy exercise to show that an ideal  $I$  is radical if and only if  $I = \sqrt{I}$ . A somewhat more surprising fact is that the radical of an ideal is always an ideal. To see what is at stake here, consider, for example, the ideal  $J = \langle x^2, y^3 \rangle \subset k[x, y]$ . Although neither  $x$  nor  $y$  belongs to  $J$ , it is clear that  $x \in \sqrt{J}$  and  $y \in \sqrt{J}$ . Note that  $(x \cdot y)^2 = x^2 y^2 \in J$  since  $x^2 \in J$ ; thus,  $x \cdot y \in \sqrt{J}$ . It is less obvious that  $x + y \in \sqrt{J}$ . To see this, observe that

$$(x + y)^4 = x^4 + 4x^3y + 6x^2y^2 + 4xy^3 + y^4 \in J$$

because  $x^4, 4x^3y, 6x^2y^2 \in J$  (they are all multiples of  $x^2$ ) and  $4xy^3, y^4 \in J$  (because they are multiples of  $y^3$ ). Thus,  $x + y \in \sqrt{J}$ . By way of contrast, neither  $xy$  nor  $x + y$  belong to  $J$ .

**Lemma 5.** If  $I$  is an ideal in  $k[x_1, \dots, x_n]$ , then  $\sqrt{I}$  is an ideal in  $k[x_1, \dots, x_n]$  containing  $I$ . Furthermore,  $\sqrt{I}$  is a radical ideal.

**Proof.** We have already shown that  $I \subset \sqrt{I}$ . To show  $\sqrt{I}$  is an ideal, suppose  $f, g \in \sqrt{I}$ . Then there are positive integers  $m$  and  $l$  such that  $f^m, g^l \in I$ . In the binomial expansion of  $(f + g)^{m+l-1}$  every term has a factor  $f^i g^j$  with  $i + j = m + l - 1$ . Since either  $i \geq m$  or  $j \geq l$ , either  $f^i$  or  $g^j$  is in  $I$ , whence  $f^i g^j \in I$  and every term in the binomial expansion is in  $I$ . Hence,  $(f + g)^{m+l-1} \in I$  and, therefore,  $f + g \in \sqrt{I}$ . Finally, suppose  $f \in \sqrt{I}$  and  $h \in k[x_1, \dots, x_n]$ . Then  $f^m \in I$  for some integer  $m \geq 1$ . Since  $I$  is an ideal, we have  $(h \cdot f)^m = h^m f^m \in I$ . Hence,  $hf \in \sqrt{I}$ . This shows that  $\sqrt{I}$  is an ideal. In Exercise 4, you will show that  $\sqrt{I}$  is a radical ideal.  $\square$

We are now ready to state the ideal-theoretic form of the Nullstellensatz.

**Theorem 6 (The Strong Nullstellensatz).** Let  $k$  be an algebraically closed field. If  $I$  is an ideal in  $k[x_1, \dots, x_n]$ , then

$$\mathbf{I}(\mathbf{V}(I)) = \sqrt{I}.$$

**Proof.** We certainly have  $\sqrt{I} \subset \mathbf{I}(\mathbf{V}(I))$  because  $f \in \sqrt{I}$  implies that  $f^m \in I$  for some  $m$ . Hence,  $f^m$  vanishes on  $\mathbf{V}(I)$ , which implies that  $f$  vanishes on  $\mathbf{V}(I)$ . Thus,  $f \in \mathbf{I}(\mathbf{V}(I))$ .

Conversely, suppose that  $f \in \mathbf{I}(\mathbf{V}(I))$ . Then, by definition,  $f$  vanishes on  $\mathbf{V}(I)$ . By Hilbert’s Nullstellensatz, there exists an integer  $m \geq 1$  such that  $f^m \in I$ . But this means that  $f \in \sqrt{I}$ . Since  $f$  was arbitrary,  $\mathbf{I}(\mathbf{V}(I)) \subset \sqrt{I}$ . This completes the proof.  $\square$

It has become a custom, to which we shall adhere, to refer to Theorem 6 as *the* Nullstellensatz with no further qualification. The most important consequence of the Nullstellensatz is that it allows us to set up a “dictionary” between geometry and algebra. The basis of the dictionary is contained in the following theorem.

**Theorem 7 (The Ideal–Variety Correspondence).** *Let  $k$  be an arbitrary field.*

(i) *The maps*

$$\text{affine varieties} \xrightarrow{\mathbf{I}} \text{ideals}$$

*and*

$$\text{ideals} \xrightarrow{\mathbf{V}} \text{affine varieties}$$

*are inclusion-reversing, i.e., if  $I_1 \subset I_2$  are ideals, then  $\mathbf{V}(I_1) \supset \mathbf{V}(I_2)$  and, similarly, if  $V_1 \subset V_2$  are varieties, then  $\mathbf{I}(V_1) \supset \mathbf{I}(V_2)$ . Furthermore, for any variety  $V$ , we have*

$$\mathbf{V}(\mathbf{I}(V)) = V,$$

*so that  $\mathbf{I}$  is always one-to-one.*

(ii) *If  $k$  is algebraically closed, and if we restrict to radical ideals, then the maps*

$$\text{affine varieties} \xrightarrow{\mathbf{I}} \text{radical ideals}$$

*and*

$$\text{radical ideals} \xrightarrow{\mathbf{V}} \text{affine varieties}$$

*are inclusion-reversing bijections which are inverses of each other.*

**Proof.** (i) In the exercises you will show that  $\mathbf{I}$  and  $\mathbf{V}$  are inclusion-reversing. It remains to prove that  $\mathbf{V}(\mathbf{I}(V)) = V$  when  $V = \mathbf{V}(f_1, \dots, f_s)$  is a subvariety of  $k^n$ . Since every  $f \in \mathbf{I}(V)$  vanishes on  $V$ , the inclusion  $V \subset \mathbf{V}(\mathbf{I}(V))$  follows directly from the definition of  $\mathbf{V}$ . Going the other way, note that  $f_1, \dots, f_s \in \mathbf{I}(V)$  by the definition of  $\mathbf{I}$ , and, thus,  $\langle f_1, \dots, f_s \rangle \subset \mathbf{I}(V)$ . Since  $\mathbf{V}$  is inclusion-reversing, it follows that  $\mathbf{V}(\mathbf{I}(V)) \subset \mathbf{V}(\langle f_1, \dots, f_s \rangle) = V$ . This proves the desired equality  $\mathbf{V}(\mathbf{I}(V)) = V$ , and, consequently,  $\mathbf{I}$  is one-to-one since it has a left inverse.

(ii) Since  $\mathbf{I}(V)$  is radical by Corollary 3, we can think of  $\mathbf{I}$  as a function which takes varieties to radical ideals. Furthermore, we already know  $\mathbf{V}(\mathbf{I}(V)) = V$  for any variety  $V$ . It remains to prove  $\mathbf{I}(\mathbf{V}(I)) = I$  whenever  $I$  is a radical ideal. This is easy: the Nullstellensatz tells us  $\mathbf{I}(\mathbf{V}(I)) = \sqrt{I}$ , and  $I$  being radical implies  $\sqrt{I} = I$  (see

Exercise 4). This gives the desired equality. Hence,  $\mathbf{V}$  and  $\mathbf{I}$  are inverses of each other and, thus, define bijections between the set of radical ideals and affine varieties. The theorem is proved.  $\square$

As a consequence of this theorem, any question about varieties can be rephrased as an algebraic question about radical ideals (and conversely), provided that we are working over an algebraically closed field. This ability to pass between algebra and geometry will give us considerable power.

In view of the Nullstellensatz and the importance it assigns to radical ideals, it is natural to ask whether one can compute generators for the radical from generators of the original ideal. In fact, there are three questions to ask concerning an ideal  $I = \langle f_1, \dots, f_s \rangle$ :

- (Radical Generators) Is there an algorithm which produces a set  $\{g_1, \dots, g_m\}$  of polynomials such that  $\sqrt{I} = \langle g_1, \dots, g_m \rangle$ ?
- (Radical Ideal) Is there an algorithm which will determine whether  $I$  is radical?
- (Radical Membership) Given  $f \in k[x_1, \dots, x_n]$ , is there an algorithm which will determine whether  $f \in \sqrt{I}$ ?

The existence of these algorithms follows from work of HERMANN (1926) [see also MINES, RICHMAN, and RUITENBERG (1988) and SEIDENBERG (1974, 1984) for more modern expositions]. Unfortunately, the algorithms given in these papers for the first two questions are not very practical and would not be suitable for using on a computer. However, work by GIANNI, TRAGER and ZACHARIAS (1988) has led to an algorithm implemented in AXIOM and REDUCE for finding the radical of an ideal. This algorithm is described in detail in Theorem 8.99 of BECKER and WEISPFENNING (1993). A different algorithm for radicals, due to EISENBUD, HUNEKE and VASCONCELOS (1992), has been implemented in Macaulay 2.

For now, we will settle for solving the more modest *radical membership problem*. To test whether  $f \in \sqrt{I}$ , we could use the ideal membership algorithm to check whether  $f^m \in I$  for all integers  $m > 0$ . This is not satisfactory because we might have to go to very large powers of  $m$ , and it will never tell us if  $f \notin \sqrt{I}$  (at least, not until we work out *a priori* bounds on  $m$ ). Fortunately, we can adapt the proof of Hilbert's Nullstellensatz to give an algorithm for determining whether  $f \in \sqrt{\langle f_1, \dots, f_s \rangle}$ .

**Proposition 8 (Radical Membership).** *Let  $k$  be an arbitrary field and let  $I = \langle f_1, \dots, f_s \rangle \subset k[x_1, \dots, x_n]$  be an ideal. Then  $f \in \sqrt{I}$  if and only if the constant polynomial 1 belongs to the ideal  $\tilde{I} = \langle f_1, \dots, f_s, 1 - yf \rangle \subset k[x_1, \dots, x_n, y]$  (in which case,  $\tilde{I} = k[x_1, \dots, x_n, y]$ ).*

**Proof.** From equations (2), (3), and (4) in the proof of Hilbert's Nullstellensatz in §1, we see that  $1 \in \tilde{I}$  implies  $f^m \in I$  for some  $m$ , which, in turn, implies  $f \in \sqrt{I}$ . Going the other way, suppose that  $f \in \sqrt{I}$ . Then  $f^m \in I \subset \tilde{I}$  for some  $m$ . But we also have  $1 - yf \in \tilde{I}$ , and, consequently,

$$1 = y^m f^m + (1 - y^m f^m) = y^m \cdot f^m + (1 - yf) \cdot (1 + yf + \dots + y^{m-1} f^{m-1}) \in \tilde{I},$$

as desired.  $\square$

Proposition 8, together with our earlier remarks on determining whether 1 belongs to an ideal (see the discussion of the consistency problem in §1), immediately leads to the **radical membership algorithm**. That is, to determine if  $f \in \sqrt{\langle f_1, \dots, f_s \rangle} \subset k[x_1, \dots, x_n]$ , we compute a reduced Groebner basis of the ideal  $\langle f_1, \dots, f_s, 1 - yf \rangle \subset k[x_1, \dots, x_n, y]$  with respect to some ordering. If the result is  $\{1\}$ , then  $f \in \sqrt{I}$ . Otherwise,  $f \notin \sqrt{I}$ .

As an example, consider the ideal  $I = \langle xy^2 + 2y^2, x^4 - 2x^2 + 1 \rangle$  in  $k[x, y]$ . Let us test if  $f = y - x^2 + 1$  lies in  $\sqrt{I}$ . Using lex order on  $k[x, y, z]$ , one checks that the ideal

$$\tilde{I} = \langle xy^2 + 2y^2, x^4 - 2x^2 + 1, 1 - z(y - x^2 + 1) \rangle \subset k[x, y, z]$$

has reduced Groebner basis  $\{1\}$ . It follows that  $y - x^2 + 1 \in \sqrt{I}$  by Proposition 8.

Indeed, using the division algorithm, we can check what power of  $y - x^2 + 1$  lies in  $I$ :

$$\begin{aligned} \overline{y - x^2 + 1}^G &= y - x^2 + 1, \\ \overline{(y - x^2 + 1)^2}^G &= -2x^2y + 2y, \\ \overline{(y - x^2 + 1)^3}^G &= 0, \end{aligned}$$

where  $G = \{x^4 - 2x^2 + 1, y^2\}$  is a Groebner basis for  $I$  with respect to lex order and  $\overline{p}^G$  is the remainder of  $p$  on division by  $G$ . As a consequence, we see that  $(y - x^2 + 1)^3 \in I$ , but no lower power of  $y - x^2 + 1$  is in  $I$  (in particular,  $y - x^2 + 1 \notin I$ ).

We can also see what is happening in this example geometrically. As a set,  $\mathbf{V}(I) = \{(\pm 1, 0)\}$ , but (speaking somewhat imprecisely) every polynomial in  $I$  vanishes to order at least 2 at each of the two points in  $\mathbf{V}(I)$ . This is visible from the form of the generators of  $I$  if we factor them:

$$xy^2 + 2y^2 = y^2(x + 2) \quad \text{and} \quad x^4 - 2x^2 + 1 = (x^2 - 1)^2.$$

Even though  $f = y - x^2 + 1$  also vanishes at  $(\pm 1, 0)$ ,  $f$  only vanishes to order 1 there. We must take a higher power of  $f$  to obtain an element of  $I$ .

We will end this section with a discussion of the one case where we can compute the radical of an ideal, which is when we are dealing with a principal ideal  $I = \langle f \rangle$ . Recall that a polynomial  $f$  is said to be *irreducible* if it has the property that whenever  $f = g \cdot h$  for some polynomials  $g$  and  $h$ , then either  $g$  or  $h$  is a constant. We saw in §5 of Chapter 3 that any polynomial  $f$  can always be written as a product of irreducible polynomials. By collecting the irreducible polynomials which differ by constant multiples of one another, we can write  $f$  in the form

$$f = cf_1^{a_1} \cdots f_r^{a_r}, \quad c \in k,$$

where the  $f_i$ 's  $1 \leq i \leq r$ , are *distinct* irreducible polynomials. That is, where  $f_i$  and  $f_j$  are not constant multiples of one another whenever  $i \neq j$ . Moreover, this expression for  $f$  is *unique* up to reordering the  $f_i$ 's and up to multiplying the  $f_i$ 's by constant multiples. (This is just a restatement of Theorem 5 of Chapter 3, §5.) If we have  $f$  expressed as a product of irreducible polynomials, then it is easy to write down an explicit expression for the radical of the principal ideal generated by  $f$ .

**Proposition 9.** Let  $f \in k[x_1, \dots, x_n]$  and  $I = \langle f \rangle$  be the principal ideal generated by  $f$ . If  $f = c f_1^{a_1} \cdots f_r^{a_r}$  is the factorization of  $f$  into a product of distinct irreducible polynomials, then

$$\sqrt{I} = \sqrt{\langle f \rangle} = \langle f_1 f_2 \cdots f_r \rangle.$$

**Proof.** We first show that  $f_1 f_2 \cdots f_r$  belongs to  $\sqrt{I}$ . Let  $N$  be an integer strictly greater than the maximum of  $a_1, \dots, a_r$ . Then

$$(f_1 f_2 \cdots f_r)^N = f_1^{N-a_1} f_2^{N-a_2} \cdots f_r^{N-a_r} f$$

is a polynomial multiple of  $f$ . This shows that  $(f_1 f_2 \cdots f_r)^N \in I$ , which implies that  $f_1 f_2 \cdots f_r \in \sqrt{I}$ . Thus  $\langle f_1 f_2 \cdots f_r \rangle \subset \sqrt{I}$ .

Conversely, suppose that  $g \in \sqrt{I}$ . Then there exists a positive integer  $M$  such that  $g^M \in I$ . This means that  $g^M = h \cdot f$  for some polynomial  $h$ . Now suppose that  $g = g_1^{b_1} g_2^{b_2} \cdots g_s^{b_s}$  is the factorization of  $g$  into a product of distinct irreducible polynomials. Then  $g^M = g_1^{b_1 M} g_2^{b_2 M} \cdots g_s^{b_s M}$  is the factorization of  $g^M$  into a product of distinct irreducible polynomials. Thus,

$$g_1^{b_1 M} g_2^{b_2 M} \cdots g_s^{b_s M} = h \cdot f_1^{a_1} f_2^{a_2} \cdots f_r^{a_r}.$$

But, by unique factorization, the irreducible polynomials on both sides of the above equation must be the same (up to multiplication by constants). Since the  $f_1, \dots, f_r$  are irreducible; each  $f_i$ ,  $1 \leq i \leq r$  must be equal to a constant multiple of some  $g_j$ . This implies that  $g$  is a polynomial multiple of  $f_1 f_2 \cdots f_r$  and, therefore  $g$  is contained in the ideal  $\langle f_1 f_2 \cdots f_r \rangle$ . The proposition is proved.  $\square$

In view of Proposition 9, we make the following definition:

**Definition 10.** If  $f \in k[x_1, \dots, x_n]$  is a polynomial, we define the **reduction** of  $f$ , denoted  $f_{red}$ , to be the polynomial such that  $\langle f_{red} \rangle = \sqrt{\langle f \rangle}$ . A polynomial is said to be **reduced** (or **square-free**) if  $f = f_{red}$ .

Thus,  $f_{red}$  is the polynomial  $f$  with repeated factors “stripped away.” So, for example, if  $f = (x + y^2)^3(x - y)$ , then  $f_{red} = (x + y^2)(x - y)$ . Note that  $f_{red}$  is only unique up to a constant factor in  $k$ .

The usefulness of Proposition 9 is mitigated by the requirement that  $f$  be factored into irreducible factors. We might ask if there is an algorithm to compute  $f_{red}$  from  $f$  without factoring  $f$  first. It turns out that such an algorithm exists.

To state the algorithm, we will need the notion of a greatest common divisor of two polynomials.

**Definition 11.** Let  $f, g \in k[x_1, \dots, x_n]$ . Then  $h \in k[x_1, \dots, x_n]$  is called a **greatest common divisor** of  $f$  and  $g$ , and denoted  $h = \text{GCD}(f, g)$ , if

- (i)  $h$  divides  $f$  and  $g$ .
- (ii) If  $p$  is any polynomial which divides both  $f$  and  $g$ , then  $p$  divides  $h$ .

It is easy to show that  $\text{GCD}(f, g)$  exists and is unique up to multiplication by a nonzero constant in  $k$  (see Exercise 9). Unfortunately, the one-variable algorithm for finding the GCD (that is, the Euclidean Algorithm) does not work in the case of several variables. To see this, consider the polynomials  $xy$  and  $xz$  in  $k[x, y, z]$ . Clearly,  $\text{GCD}(xy, xz) = x$ . However, no matter what term ordering we use, dividing  $xy$  by  $xz$  gives 0 plus remainder  $xy$  and dividing  $xz$  by  $xy$  gives 0 plus remainder  $xz$ . As a result, neither polynomial “reduces” with respect to the other and there is no next step to which to apply the analogue of the Euclidean Algorithm.

Nevertheless, there is an algorithm for calculating the GCD of two polynomials in several variables. We defer a discussion of it until the next section after we have studied intersections of ideals. For the purposes of our discussion here, let us assume that we have such an algorithm. We also remark that given polynomials  $f_1, \dots, f_s \in k[x_1, \dots, x_n]$ , one can define  $\text{GCD}(f_1, f_2, \dots, f_s)$  exactly as in the one-variable case. There is also an algorithm for computing  $\text{GCD}(f_1, f_2, \dots, f_s)$ .

Using this notion of GCD, we can now give a formula for computing the radical of a principal ideal.

**Proposition 12.** *Suppose that  $k$  is a field containing the rational numbers  $\mathbb{Q}$  and let  $I = \langle f \rangle$  be a principal ideal in  $k[x_1, \dots, x_n]$ . Then  $\sqrt{I} = \langle f_{red} \rangle$ , where*

$$f_{red} = \frac{f}{\text{GCD}\left(f, \frac{\partial f}{\partial x_1}, \frac{\partial f}{\partial x_2}, \dots, \frac{\partial f}{\partial x_n}\right)}.$$

**Proof.** Writing  $f$  as in Proposition 9, we know that  $\sqrt{I} = \langle f_1 f_2 \cdots f_r \rangle$ . Thus, it suffices to show that

$$(1) \quad \text{GCD}\left(f, \frac{\partial f}{\partial x_1}, \dots, \frac{\partial f}{\partial x_n}\right) = f_1^{a_1-1} f_2^{a_2-1} \cdots f_r^{a_r-1}.$$

We first use the product rule to note that

$$\frac{\partial f}{\partial x_j} = f_1^{a_1-1} f_2^{a_2-1} \cdots f_r^{a_r-1} \left( a_1 \frac{\partial f_1}{\partial x_j} f_2 \cdots f_r + \cdots + a_r f_1 \cdots f_{r-1} \frac{\partial f_r}{\partial x_j} \right).$$

This proves that  $f_1^{a_1-1} f_2^{a_2-1} \cdots f_r^{a_r-1}$  divides the GCD. It remains to show that for each  $i$ , there is some  $\frac{\partial f}{\partial x_j}$  which is not divisible by  $f_i^{a_i}$ .

Write  $f = f_i^{a_i} h_i$ , where  $h_i$  is not divisible by  $f_i$ . Since  $f_i$  is nonconstant, some variable  $x_j$  must appear in  $f_i$ . The product rule gives us

$$\frac{\partial f}{\partial x_j} = f_i^{a_i-1} \left( a_i \frac{\partial f_i}{\partial x_j} h_i + f_i \frac{\partial h_i}{\partial x_j} \right).$$

If this expression is divisible by  $f_i^{a_i}$ , then  $\frac{\partial f_i}{\partial x_j} h_i$  must be divisible by  $f_i$ . Since  $f_i$  is irreducible and does not divide  $h_i$ , this forces  $f_i$  to divide  $\frac{\partial f_i}{\partial x_j}$ . In Exercise 13, you will show that  $\frac{\partial f_i}{\partial x_j}$  is nonzero since  $\mathbb{Q} \subset k$  and  $x_j$  appears in  $f_i$ . As  $\frac{\partial f_i}{\partial x_j}$  also has smaller total

degree than  $f_i$ , it follows that  $f_i$  cannot divide  $\frac{\partial f_i}{\partial x_j}$ . Consequently,  $\frac{\partial f}{\partial x_j}$  is not divisible by  $f_i^{a_i}$ , which proves (1), and the proposition follows.  $\square$

It is worth remarking that for fields which do not contain  $\mathbb{Q}$ , the above formula for  $f_{red}$  may fail (see Exercise 13).

### EXERCISES FOR §2

- Given a field  $k$  (not necessarily algebraically closed), show that  $\sqrt{\langle x^2, y^2 \rangle} = \langle x, y \rangle$  and, more generally, show that  $\sqrt{\langle x^n, y^m \rangle} = \langle x, y \rangle$  for any positive integers  $n$  and  $m$ .
- Let  $f$  and  $g$  be distinct nonconstant polynomials in  $k[x, y]$  and let  $I = \langle f^2, g^3 \rangle$ . Is it necessarily true that  $\sqrt{I} = \langle f, g \rangle$ ? Explain.
- Show that  $\langle x^2 + 1 \rangle \subset \mathbb{R}[x]$  is a radical ideal, but that  $\mathbf{V}(x^2 + 1)$  is the empty variety.
- Let  $I$  be an ideal in  $k[x_1, \dots, x_n]$ , where  $k$  is an arbitrary field.
  - Show that  $\sqrt{I}$  is a radical ideal.
  - Show that  $I$  is radical if and only if  $I = \sqrt{I}$ .
  - Show that  $\sqrt{\sqrt{I}} = \sqrt{I}$ .
- Prove that  $\mathbf{I}$  and  $\mathbf{V}$  are inclusion-reversing.
- Let  $I$  be an ideal in  $k[x_1, \dots, x_n]$ .
  - In the special case when  $\sqrt{I} = \langle f_1, f_2 \rangle$ , with  $f_i^{m_i} \in I$ , prove that  $f^{m_1+m_2-1} \in I$  for all  $f \in \sqrt{I}$ .
  - Now prove that for any  $I$ , there exists  $m_0$  such that  $f^{m_0} \in I$  for all  $f \in \sqrt{I}$ . Hint: Write  $\sqrt{I} = \langle f_1, \dots, f_s \rangle$ .
- Determine whether the following polynomials lie in the following radicals. If the answer is yes, what is the smallest power of the polynomial that lies in the ideal?
  - Is  $x + y \in \sqrt{\langle x^3, y^3, xy(x+y) \rangle}$ ?
  - Is  $x^2 + 3xz \in \sqrt{\langle x + z, x^2y, x - z^2 \rangle}$ ?
- Show that if  $f_m$  and  $f_{m+1}$  are homogeneous polynomials of degree  $m$  and  $m + 1$ , respectively, with no common factors [i.e.,  $\text{GCD}(f_m, f_{m+1}) = 1$ ], then  $h = f_m + f_{m+1}$  is irreducible.
- Given  $f, g \in k[x_1, \dots, x_n]$ , use unique factorization to prove that  $\text{GCD}(f, g)$  exists. Also prove that  $\text{GCD}(f, g)$  is unique up to multiplication by a nonzero constant of  $k$ .
- Prove the following ideal-theoretic characterization of  $\text{GCD}(f, g)$ : given  $f, g, h$  in  $k[x_1, \dots, x_n]$ , then  $h = \text{GCD}(f, g)$  if and only if  $h$  is a generator of the smallest principal ideal containing  $\langle f, g \rangle$  (that is, if  $\langle h \rangle \subset J$ , whenever  $J$  is a principal ideal such that  $J \supset \langle f, g \rangle$ ).
- Find a basis for the ideal

$$\sqrt{\langle x^5 - 2x^4 + 2x^2 - x, x^5 - x^4 - 2x^3 + 2x^2 + x - 1 \rangle}.$$

Compare with Exercise 17 of Chapter 1, §5.

- Let  $f = x^5 + 3x^4y + 3x^3y^2 - 2x^4y^2 + x^2y^3 - 6x^3y^3 - 6x^2y^4 + x^3y^4 - 2xy^5 + 3x^2y^5 + 3xy^6 + y^7 \in \mathbb{Q}[x, y]$ . Compute  $\sqrt{\langle f \rangle}$ .
- A field  $k$  has *characteristic zero* if it contains the rational numbers  $\mathbb{Q}$ ; otherwise,  $k$  has *positive characteristic*.
  - Let  $k$  be the field  $\mathbb{F}_2$  from Exercise 1 of Chapter 1, §1. If  $f = x_1^2 + \dots + x_n^2 \in \mathbb{F}_2[x_1, \dots, x_n]$ , then show that  $\frac{\partial f}{\partial x_i} = 0$  for all  $i$ . Conclude that the formula given in Proposition 12 may fail when the field is  $\mathbb{F}_2$ .

- b. Let  $k$  be a field of characteristic zero and let  $f \in k[x_1, \dots, x_n]$  be nonconstant. If the variable  $x_j$  appears in  $f$ , then prove that  $\frac{\partial f}{\partial x_j} \neq 0$ . Also explain why  $\frac{\partial f}{\partial x_j}$  has smaller total degree than  $f$ .
14. Let  $J = \langle xy, (x - y)x \rangle$ . Describe  $\mathbf{V}(J)$  and show that  $\sqrt{J} = \langle x \rangle$ .
15. Prove that  $I = \langle xy, xz, yz \rangle$  is a radical ideal. Hint: If you divide  $f \in k[x, y, z]$  by  $xy, xz, yz$ , what does the remainder look like? What does  $f^m$  look like?

### §3 Sums, Products, and Intersections of Ideals

Ideals are algebraic objects and, as a result, there are natural algebraic operations we can define on them. In this section, we consider three such operations: sum, intersection, and product. These are binary operations: to each pair of ideals, they associate a new ideal. We shall be particularly interested in two general questions which arise in connection with each of these operations. The first asks how, given generators of a pair of ideals, one can compute generators of the new ideals which result on applying these operations. The second asks for the geometric significance of these algebraic operations. Thus, the first question fits the general computational theme of this book; the second, the general thrust of this chapter. We consider each of the operations in turn.

#### *Sums of Ideals*

**Definition 1.** *If  $I$  and  $J$  are ideals of the ring  $k[x_1, \dots, x_n]$ , then the **sum** of  $I$  and  $J$ , denoted  $I + J$ , is the set*

$$I + J = \{f + g : f \in I \text{ and } g \in J\}.$$

**Proposition 2.** *If  $I$  and  $J$  are ideals in  $k[x_1, \dots, x_n]$ , then  $I + J$  is also an ideal in  $k[x_1, \dots, x_n]$ . In fact,  $I + J$  is the smallest ideal containing  $I$  and  $J$ . Furthermore, if  $I = \langle f_1, \dots, f_r \rangle$  and  $J = \langle g_1, \dots, g_s \rangle$ , then  $I + J = \langle f_1, \dots, f_r, g_1, \dots, g_s \rangle$ .*

**Proof.** Note first that  $0 = 0 + 0 \in I + J$ . Suppose  $h_1, h_2 \in I + J$ . By the definition of  $I + J$ , there exist  $f_1, f_2 \in I$  and  $g_1, g_2 \in J$  such that  $h_1 = f_1 + g_1, h_2 = f_2 + g_2$ . Then, after rearranging terms slightly,  $h_1 + h_2 = (f_1 + f_2) + (g_1 + g_2)$ . But  $f_1 + f_2 \in I$  because  $I$  is an ideal and, similarly,  $g_1 + g_2 \in J$ , whence  $h_1 + h_2 \in I + J$ . To check closure under multiplication, let  $h \in I + J$  and  $l \in k[x_1, \dots, x_n]$  be any polynomial. Then, as above, there exist  $f \in I$  and  $g \in J$  such that  $h = f + g$ . But then  $l \cdot h = l \cdot (f + g) = l \cdot f + l \cdot g$ . Now  $l \cdot f \in I$  and  $l \cdot g \in J$  because  $I$  and  $J$  are ideals. Consequently,  $l \cdot h \in I + J$ . This shows that  $I + J$  is an ideal.

If  $H$  is an ideal which contains  $I$  and  $J$ , then  $H$  must contain all elements  $f \in I$  and  $g \in J$ . Since  $H$  is an ideal,  $H$  must contain all  $f + g$ , where  $f \in I, g \in J$ . In particular,  $H \supset I + J$ . Therefore, every ideal containing  $I$  and  $J$  contains  $I + J$  and, thus,  $I + J$  must be the smallest such ideal. Finally, if  $I = \langle f_1, \dots, f_r \rangle$  and  $J = \langle g_1, \dots, g_s \rangle$ , then  $\langle f_1, \dots, f_r, g_1, \dots, g_s \rangle$  is an ideal containing  $I$  and  $J$ , so that



$I + J \subset \langle f_1, \dots, f_r, g_1, \dots, g_s \rangle$ . The reverse inclusion is obvious, so that  $I + J = \langle f_1, \dots, f_r, g_1, \dots, g_s \rangle$ .  $\square$

The following corollary is an immediate consequence of Proposition 2.

**Corollary 3.** *If  $f_1, \dots, f_r \in k[x_1, \dots, x_n]$ , then*

$$\langle f_1, \dots, f_r \rangle = \langle f_1 \rangle + \dots + \langle f_r \rangle.$$

To see what happens geometrically, let  $I = \langle x^2 + y \rangle$  and  $J = \langle z \rangle$  be ideals in  $\mathbb{R}[x, y, z]$ . We have sketched  $\mathbf{V}(I)$  and  $\mathbf{V}(J)$  below. Then  $I + J = \langle x^2 + y, z \rangle$  contains both  $x^2 + y$  and  $z$ . Thus, the variety  $\mathbf{V}(I + J)$  must consist of those points where both  $x^2 + y$  and  $z$  vanish. That is, it must be the intersection of  $\mathbf{V}(I)$  and  $\mathbf{V}(J)$ .

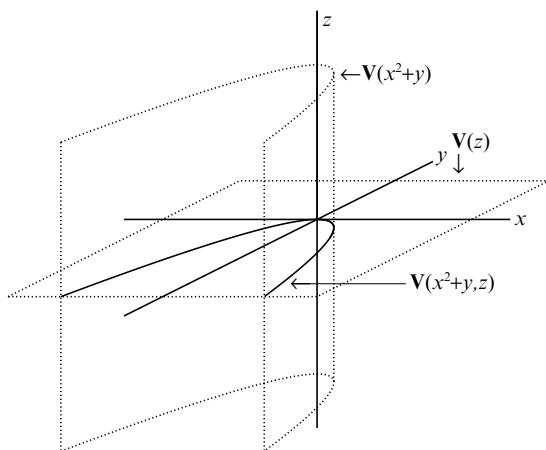

The same line of reasoning generalizes to show that addition of ideals corresponds geometrically to taking intersections of varieties.

**Theorem 4.** *If  $I$  and  $J$  are ideals in  $k[x_1, \dots, x_n]$ , then  $\mathbf{V}(I + J) = \mathbf{V}(I) \cap \mathbf{V}(J)$ .*

**Proof.** If  $x \in \mathbf{V}(I + J)$ , then  $x \in \mathbf{V}(I)$  because  $I \subset I + J$ ; similarly,  $x \in \mathbf{V}(J)$ . Thus,  $x \in \mathbf{V}(I) \cap \mathbf{V}(J)$  and we conclude that  $\mathbf{V}(I + J) \subset \mathbf{V}(I) \cap \mathbf{V}(J)$ .

To get the opposite inclusion, suppose  $x \in \mathbf{V}(I) \cap \mathbf{V}(J)$ . Let  $h$  be any polynomial in  $I + J$ . Then there exist  $f \in I$  and  $g \in J$  such that  $h = f + g$ . We have  $f(x) = 0$  because  $x \in \mathbf{V}(I)$  and  $g(x) = 0$  because  $x \in \mathbf{V}(J)$ . Thus,  $h(x) = f(x) + g(x) = 0 + 0 = 0$ . Since  $h$  was arbitrary, we conclude that  $x \in \mathbf{V}(I + J)$ . Hence,  $\mathbf{V}(I + J) \supset \mathbf{V}(I) \cap \mathbf{V}(J)$ .  $\square$

An analogue of Theorem 4, stated in terms of generators was given in Lemma 2 of Chapter 1, §2.

## Products of Ideals

In Lemma 2 of Chapter 1, §2, we encountered the fact that an ideal generated by the products of the generators of two other ideals corresponds to the union of varieties:

$$\mathbf{V}(f_1, \dots, f_r) \cup \mathbf{V}(g_1, \dots, g_s) = \mathbf{V}(f_i g_j, 1 \leq i \leq r, 1 \leq j \leq s).$$

Thus, for example, the variety  $\mathbf{V}(xz, yz)$  corresponding to an ideal generated by the product of the generators of the ideals,  $\langle x, y \rangle$  and  $\langle z \rangle$  in  $k[x, y, z]$  is the union of  $\mathbf{V}(x, y)$  (the  $z$ -axis) and  $\mathbf{V}(z)$  (the  $xy$ -plane). This suggests the following definition.

**Definition 5.** If  $I$  and  $J$  are two ideals in  $k[x_1, \dots, x_n]$ , then their **product**, denoted  $I \cdot J$ , is defined to be the ideal generated by all polynomials  $f \cdot g$  where  $f \in I$  and  $g \in J$ .

Thus, the product  $I \cdot J$  of  $I$  and  $J$  is the set

$$I \cdot J = \{f_1 g_1 + \dots + f_r g_r : f_1, \dots, f_r \in I, g_1, \dots, g_r \in J, r \text{ a positive integer}\}.$$

To see that this is an ideal, note that  $0 = 0 \cdot 0 \in I \cdot J$ . Moreover, it is clear that  $h_1, h_2 \in I \cdot J$  implies that  $h_1 + h_2 \in I \cdot J$ . Finally, if  $h = f_1 g_1 + \dots + f_r g_r \in I \cdot J$  and  $p$  is any polynomial, then

$$ph = (pf_1)g_1 + \dots + (pf_r)g_r \in I \cdot J$$

since  $pf_i \in I$  for all  $i$ ,  $1 \leq i \leq r$ . Note that the set of products would not be an ideal because it would not be closed under addition. The following easy proposition shows that computing a set of generators for  $I \cdot J$  given sets of generators for  $I$  and  $J$  is completely straightforward.

**Proposition 6.** Let  $I = \langle f_1, \dots, f_r \rangle$  and  $J = \langle g_1, \dots, g_s \rangle$ . Then  $I \cdot J$  is generated by the set of all products of generators of  $I$  and  $J$ :

$$I \cdot J = \langle f_i g_j : 1 \leq i \leq r, 1 \leq j \leq s \rangle.$$

**Proof.** It is clear that the ideal generated by products  $f_i g_j$  of the generators is contained in  $I \cdot J$ . To establish the opposite inclusion, note that any polynomial in  $I \cdot J$  is a sum of polynomials of the form  $fg$  with  $f \in I$  and  $g \in J$ . But we can write  $f$  and  $g$  in terms of the generators  $f_1, \dots, f_r$  and  $g_1, \dots, g_s$ , respectively, as

$$f = a_1 f_1 + \dots + a_r f_r, \quad g = b_1 g_1 + \dots + b_s g_s$$

for appropriate polynomials  $a_1, \dots, a_r, b_1, \dots, b_s$ . Thus,  $fg$ , and any sum of polynomials of this form, can be written as a sum  $\sum c_{ij} f_i g_j$ , where  $c_{ij} \in k[x_1, \dots, x_n]$ .  $\square$

The following proposition guarantees that the product of ideals does indeed correspond geometrically to the operation of taking the union of varieties.

**Theorem 7.** If  $I$  and  $J$  are ideals in  $k[x_1, \dots, x_n]$ , then  $\mathbf{V}(I \cdot J) = \mathbf{V}(I) \cup \mathbf{V}(J)$ .

**Proof.** Let  $x \in \mathbf{V}(I \cdot J)$ . Then  $g(x)h(x) = 0$  for all  $g \in I$  and all  $h \in J$ . If  $g(x) = 0$  for all  $g \in I$ , then  $x \in \mathbf{V}(I)$ . If  $g(x) \neq 0$  for some  $g \in I$ , then we must have  $h(x) = 0$  for all  $h \in J$ . In either event,  $x \in \mathbf{V}(I) \cup \mathbf{V}(J)$ .

Conversely, suppose  $x \in \mathbf{V}(I) \cup \mathbf{V}(J)$ . Either  $g(x) = 0$  for all  $g \in I$  or  $h(x) = 0$  for all  $h \in J$ . Thus,  $g(x)h(x) = 0$  for all  $g \in I$  and  $h \in J$ . Thus,  $f(x) = 0$  for all  $f \in I \cdot J$  and, hence,  $x \in \mathbf{V}(I \cdot J)$ .  $\square$

In what follows, we will often write the product of ideals as  $IJ$  rather than  $I \cdot J$ .

## Intersections of Ideals

The operation of forming the intersection of two ideals is, in some ways, even more primitive than the operations of addition and multiplication.

**Definition 8.** *The intersection  $I \cap J$  of two ideals  $I$  and  $J$  in  $k[x_1, \dots, x_n]$  is the set of polynomials which belong to both  $I$  and  $J$ .*

As in the case of sums, the set of ideals is closed under intersections.

**Proposition 9.** *If  $I$  and  $J$  are ideals in  $k[x_1, \dots, x_n]$ , then  $I \cap J$  is also an ideal.*

**Proof.** Note that  $0 \in I \cap J$  since  $0 \in I$  and  $0 \in J$ . If  $f, g \in I \cap J$ , then  $f + g \in I$  because  $f, g \in I$ . Similarly,  $f + g \in J$  and, hence,  $f + g \in I \cap J$ . Finally, to check closure under multiplication, let  $f \in I \cap J$  and  $h$  be any polynomial in  $k[x_1, \dots, x_n]$ . Since  $f \in I$  and  $I$  is an ideal, we have  $h \cdot f \in I$ . Similarly,  $h \cdot f \in J$  and, hence,  $h \cdot f \in I \cap J$ .  $\square$

Note that we always have  $IJ \subset I \cap J$  since elements of  $IJ$  are sums of polynomials of the form  $fg$  with  $f \in I$  and  $g \in J$ . But the latter belongs to both  $I$  (since  $f \in I$ ) and  $J$  (since  $g \in J$ ). However,  $IJ$  can be strictly contained in  $I \cap J$ . For example, if  $I = J = \langle x, y \rangle$ , then  $IJ = \langle x^2, xy, y^2 \rangle$  is strictly contained in  $I \cap J = I = \langle x, y \rangle$  ( $x \in I \cap J$ , but  $x \notin IJ$ ).

Given two ideals and a set of generators for each, we would like to be able to compute a set of generators for the intersection. This is much more delicate than the analogous problems for sums and products of ideals, which were entirely straightforward. To see what is involved, suppose  $I$  is the ideal in  $\mathbb{Q}[x, y]$  generated by the polynomial  $f = (x + y)^4(x^2 + y)^2(x - 5y)$  and let  $J$  be the ideal generated by the polynomial  $g = (x + y)(x^2 + y)^3(x + 3y)$ . We leave it as an (easy) exercise to check that

$$I \cap J = \langle (x + y)^4(x^2 + y)^3(x - 5y)(x + 3y) \rangle.$$

This computation is easy precisely because we were given factorizations of  $f$  and  $g$  into irreducible polynomials. In general, such factorizations may not be available. So any algorithm which allows one to compute intersections will have to be powerful enough to circumvent this difficulty.

Nevertheless, there is a nice trick which reduces the computation of intersections to computing the intersection of an ideal with a subring (i.e., eliminating variables), a problem which we have already solved. To state the theorem, we need a little notation: if  $I$  is an ideal in  $k[x_1, \dots, x_n]$  and  $f(t) \in k[t]$  a polynomial in the single variable  $t$ , then  $fI$  denotes the ideal in  $k[x_1, \dots, x_n, t]$  generated by the set of polynomials  $\{f \cdot h : h \in I\}$ . This is a little different from our usual notion of product in that the ideal  $I$  and the ideal generated by  $f(t)$  in  $k[t]$  lie in different rings: in fact, the ideal  $I \subset k[x_1, \dots, x_n]$  is *not* an ideal in  $k[x_1, \dots, x_n, t]$  because it is not closed under multiplication by  $t$ . When we want to stress that the polynomial  $f \in k[t]$  is a polynomial in  $t$  alone, we write  $f = f(t)$ . Similarly, to stress that a polynomial  $h \in k[x_1, \dots, x_n]$  involves only the variables  $x_1, \dots, x_n$ , we write  $h = h(x)$ . Along the same lines, if we are considering a polynomial  $g$  in  $k[x_1, \dots, x_n, t]$  and we want to emphasize that it can involve the variables  $x_1, \dots, x_n$  as well as  $t$ , we will write  $g = g(x, t)$ . In terms of this notation,  $fI = f(t)I = \langle f(t)h(x) : h(x) \in I \rangle$ . So, for example, if  $f(t) = t^2 - t$  and  $I = \langle x, y \rangle$ , then the ideal  $f(t)I$  in  $k[x, y, t]$  contains  $(t^2 - t)x$  and  $(t^2 - t)y$ . In fact, it is not difficult to see that  $f(t)I$  is generated as an ideal by  $(t^2 - t)x$  and  $(t^2 - t)y$ . This is a special case of the following assertion.

**Lemma 10.**

- (i) If  $I$  is generated as an ideal in  $k[x_1, \dots, x_n]$  by  $p_1(x), \dots, p_r(x)$ , then  $f(t)I$  is generated as an ideal in  $k[x_1, \dots, x_n, t]$  by  $f(t) \cdot p_1(x), \dots, f(t) \cdot p_r(x)$ .  
 (ii) If  $g(x, t) \in f(t)I$  and  $a$  is any element of the field  $k$ , then  $g(x, a) \in I$ .

**Proof.** To prove the first assertion, note that any polynomial  $g(x, t) \in f(t)I$  can be expressed as a sum of terms of the form  $h(x, t) \cdot f(t) \cdot p(x)$  for  $h \in k[x_1, \dots, x_n, t]$  and  $p \in I$ . But because  $I$  is generated by  $p_1, \dots, p_r$  the polynomial  $p(x)$  can be expressed as a sum of terms of the form  $q_i(x)p_i(x)$ ,  $1 \leq i \leq r$ . That is,

$$p(x) = \sum_{i=1}^r q_i(x)p_i(x).$$

Hence,

$$h(x, t) \cdot f(t) \cdot p(x) = \sum_{i=1}^r h(x, t)q_i(x)f(t)p_i(x).$$

Now, for each  $i$ ,  $1 \leq i \leq r$ ,  $h(x, t) \cdot q_i(x) \in k[x_1, \dots, x_n, t]$ . Thus,  $h(x, t) \cdot f(t) \cdot p(x)$  belongs to the ideal in  $k[x_1, \dots, x_n, t]$  generated by  $f(t) \cdot p_1(x), \dots, f(t) \cdot p_r(x)$ . Since  $g(x, t)$  is a sum of such terms,

$$g(x, t) \in \langle f(t) \cdot p_1(x), \dots, f(t) \cdot p_r(x) \rangle,$$

which establishes (i). The second assertion follows immediately upon substituting  $a \in k$  for  $t$ .  $\square$

**Theorem 11.** Let  $I, J$  be ideals in  $k[x_1, \dots, x_n]$ . Then

$$I \cap J = (tI + (1 - t)J) \cap k[x_1, \dots, x_n].$$

**Proof.** Note that  $tI + (1 - t)J$  is an ideal in  $k[x_1, \dots, x_n, t]$ . To establish the desired equality, we use the usual strategy of proving containment in both directions.

Suppose  $f \in I \cap J$ . Since  $f \in I$ , we have  $t \cdot f \in tI$ . Similarly,  $f \in J$  implies  $(1 - t) \cdot f \in (1 - t)J$ . Thus,  $f = t \cdot f + (1 - t) \cdot f \in tI + (1 - t)J$ . Since  $I, J \subset k[x_1, \dots, x_n]$ , we have  $f \in (tI + (1 - t)J) \cap k[x_1, \dots, x_n]$ . This shows that  $I \cap J \subset (tI + (1 - t)J) \cap k[x_1, \dots, x_n]$ .

To establish containment in the opposite direction, suppose  $f \in (tI + (1 - t)J) \cap k[x_1, \dots, x_n]$ . Then  $f(x) = g(x, t) + h(x, t)$ , where  $g(x, t) \in tI$  and  $h(x, t) \in (1 - t)J$ . First set  $t = 0$ . Since every element of  $tI$  is a multiple of  $t$ , we have  $g(x, 0) = 0$ . Thus,  $f(x) = h(x, 0)$  and hence,  $f(x) \in J$  by Lemma 10. On the other hand, set  $t = 1$  in the relation  $f(x) = g(x, t) + h(x, t)$ . Since every element of  $(1 - t)J$  is a multiple of  $1 - t$ , we have  $h(x, 1) = 0$ . Thus,  $f(x) = g(x, 1)$  and, hence,  $f(x) \in I$  by Lemma 10. Since  $f$  belongs to both  $I$  and  $J$ , we have  $f \in I \cap J$ . Thus,  $I \cap J \supset (tI + (1 - t)J) \cap k[x_1, \dots, x_n]$  and this completes the proof.  $\square$

The above result and the Elimination Theorem (Theorem 2 of Chapter 3, §1) lead to the following **algorithm for computing intersections of ideals**: if  $I = \langle f_1, \dots, f_r \rangle$  and  $J = \langle g_1, \dots, g_s \rangle$  are ideals in  $k[x_1, \dots, x_n]$ , we consider the ideal

$$\langle tf_1, \dots, tf_r, (1 - t)g_1, \dots, (1 - t)g_s \rangle \subset k[x_1, \dots, x_n, t]$$

and compute a Groebner basis with respect to lex order in which  $t$  is greater than the  $x_i$ . The elements of this basis which do not contain the variable  $t$  will form a basis (in fact, a Groebner basis) of  $I \cap J$ . For more efficient calculations, one could also use one of the orders described in Exercises 5 and 6 of Chapter 3, §1. An algorithm for intersecting three or more ideals is described in Proposition 6.19 of BECKER and WEISPFENNING (1993).

As a simple example of the above procedure, suppose we want to compute the intersection of the ideals  $I = \langle x^2y \rangle$  and  $J = \langle xy^2 \rangle$  in  $\mathbb{Q}[x, y]$ . We consider the ideal

$$tI + (1 - t)J = \langle tx^2y, (1 - t)xy^2 \rangle = \langle tx^2y, txy^2 - xy^2 \rangle$$

in  $\mathbb{Q}[t, x, y]$ . Computing the S-polynomial of the generators, we obtain  $tx^2y^2 - (tx^2y^2 - xy^2) = xy^2$ . It is easily checked that  $\{tx^2y, txy^2 - xy^2, x^2y^2\}$  is a Groebner basis of  $tI + (1 - t)J$  with respect to lex order with  $t > x > y$ . By the Elimination Theorem,  $\{x^2y^2\}$  is a (Groebner) basis of  $(tI + (1 - t)J) \cap \mathbb{Q}[x, y]$ . Thus,

$$I \cap J = \langle x^2y^2 \rangle.$$

As another example, we invite the reader to apply the algorithm for computing intersections of ideals to give an alternate proof that the intersection  $I \cap J$  of the ideals

$$I = \langle (x + y)^4(x^2 + y)^2(x - 5y) \rangle \quad \text{and} \quad J = \langle (x + y)(x^2 + y)^3(x + 3y) \rangle$$

in  $\mathbb{Q}[x, y]$  is

$$I \cap J = \langle (x + y)^4(x^2 + y)^3(x - 5y)(x + 3y) \rangle.$$

These examples above are rather simple in that our algorithm applies to ideals which are not necessarily principal, whereas the examples given here involve intersections of principal ideals. We shall see a somewhat more complicated example in the exercises.

We can generalize both of the examples above by introducing the following definition.

**Definition 12.** A polynomial  $h \in k[x_1, \dots, x_n]$  is called a **least common multiple** of  $f, g \in k[x_1, \dots, x_n]$  and denoted  $h = \text{LCM}(f, g)$  if

- (i)  $f$  divides  $h$  and  $g$  divides  $h$ .
- (ii)  $h$  divides any polynomial which both  $f$  and  $g$  divide.

For example,

$$\text{LCM}(x^2y, xy^2) = x^2y^2$$

and

$$\begin{aligned} \text{LCM}((x+y)^4(x^2+y)^2(x-5y), (x+y)(x^2+y)^3(x+3y)) \\ = (x+y)^4(x^2+y)^3(x-5y)(x+3y). \end{aligned}$$

More generally, suppose  $f, g \in k[x_1, \dots, x_n]$  and let  $f = cf_1^{a_1} \dots f_r^{a_r}$  and  $g = c'g_1^{b_1} \dots g_s^{b_s}$  be their factorizations into distinct irreducible polynomials. It may happen that some of the irreducible factors of  $f$  are constant multiples of those of  $g$ . In this case, let us suppose that we have rearranged the order of the irreducible polynomials in the expressions for  $f$  and  $g$  so that for some  $l, 1 \leq l \leq \min(r, s)$ ,  $f_i$  is a constant (nonzero) multiple of  $g_i$  for  $1 \leq i \leq l$  and for all  $i, j > l$ ,  $f_i$  is not a constant multiple of  $g_j$ . Then it follows from unique factorization that

$$(1) \quad \text{LCM}(f, g) = f_1^{\max(a_1, b_1)} \dots f_l^{\max(a_l, b_l)} \cdot g_{l+1}^{b_{l+1}} \dots g_s^{b_s} \cdot f_{l+1}^{a_{l+1}} \dots f_r^{a_r}.$$

[In the case that  $f$  and  $g$  share no common factors, we have  $\text{LCM}(f, g) = f \cdot g$ .] This, in turn, implies the following result.

**Proposition 13.**

- (i) The intersection  $I \cap J$  of two principal ideals  $I, J \subset k[x_1, \dots, x_n]$  is a principal ideal.
- (ii) If  $I = \langle f \rangle, J = \langle g \rangle$  and  $I \cap J = \langle h \rangle$ , then

$$h = \text{LCM}(f, g).$$

**Proof.** The proof will be left as an exercise. □

This result, together with our algorithm for computing the intersection of two ideals immediately gives an **algorithm for computing the least common multiple** of two polynomials. Namely, to compute the least common multiple of two polynomials  $f, g \in k[x_1, \dots, x_n]$ , we compute the intersection  $\langle f \rangle \cap \langle g \rangle$  using our algorithm for computing the intersection of ideals. Proposition 13 assures us that this intersection is a principal

ideal (in the exercises, we ask you to prove that the intersection of principal ideals is principal) and that any generator of it is a least common multiple of  $f$  and  $g$ .

This algorithm for computing least common multiples allows us to clear up a point which we left unfinished in §2: namely, the computation of the greatest common divisor of two polynomials  $f$  and  $g$ . The crucial observation is the following.

**Proposition 14.** *Let  $f, g \in k[x_1, \dots, x_n]$ . Then*

$$\text{LCM}(f, g) \cdot \text{GCD}(f, g) = fg.$$

**Proof.** See Exercise 5. You will need to express  $f$  and  $g$  as a product of distinct irreducibles and use the remarks preceding Proposition 13, especially equation (1).  $\square$

It follows immediately from Proposition 14 that

$$(2) \quad \text{GCD}(f, g) = \frac{f \cdot g}{\text{LCM}(f, g)}.$$

This gives an **algorithm for computing the greatest common divisor** of two polynomials  $f$  and  $g$ . Namely, we compute  $\text{LCM}(f, g)$  using our algorithm for the least common multiple and divide it into the product of  $f$  and  $g$  using the division algorithm.

We should point out that the GCD algorithm just described is rather cumbersome. In practice, more efficient algorithms are used [see DAVENPORT, SIRET, and TOURNIER (1993)].

Having dealt with the computation of intersections, we now ask what operation on varieties corresponds to the operation of intersection on ideals. The following result answers this question.

**Theorem 15.** *If  $I$  and  $J$  are ideals in  $k[x_1, \dots, x_n]$ , then  $\mathbf{V}(I \cap J) = \mathbf{V}(I) \cup \mathbf{V}(J)$ .*

**Proof.** Let  $x \in \mathbf{V}(I) \cup \mathbf{V}(J)$ . Then  $x \in \mathbf{V}(I)$  or  $x \in \mathbf{V}(J)$ . This means that either  $f(x) = 0$  for all  $f \in I$  or  $f(x) = 0$  for all  $f \in J$ . Thus, certainly,  $f(x) = 0$  for all  $f \in I \cap J$ . Hence,  $x \in \mathbf{V}(I \cap J)$ . Thus,  $\mathbf{V}(I) \cup \mathbf{V}(J) \subset \mathbf{V}(I \cap J)$ .

On the other hand, note that since  $IJ \subset I \cap J$ , we have  $\mathbf{V}(I \cap J) \subset \mathbf{V}(IJ)$ . But  $\mathbf{V}(IJ) = \mathbf{V}(I) \cup \mathbf{V}(J)$  by Theorem 7 and we immediately obtain the reverse inequality.  $\square$

Thus, the intersection of two ideals corresponds to the same variety as the product. In view of this and the fact that the intersection is much more difficult to compute than the product, one might legitimately question the wisdom of bothering with the intersection at all. The reason is that intersection behaves much better with respect to the operation of taking radicals: the product of radical ideals need not be a radical ideal (consider  $IJ$  where  $I = J$ ), but the intersection of radical ideals is always a

radical ideal. The latter fact follows upon applying the following proposition to radical ideals.

**Proposition 16.** *If  $I, J$  are any ideals, then*

$$\sqrt{I \cap J} = \sqrt{I} \cap \sqrt{J}.$$

**Proof.** If  $f \in \sqrt{I \cap J}$ , then  $f^m \in I \cap J$  for some integer  $m > 0$ . Since  $f^m \in I$ , we have  $f \in \sqrt{I}$ . Similarly,  $f \in \sqrt{J}$ . Thus,  $\sqrt{I \cap J} \subset \sqrt{I} \cap \sqrt{J}$ .

To establish the reverse inclusion, suppose  $f \in \sqrt{I} \cap \sqrt{J}$ . Then, there exist integers  $m, p > 0$  such that  $f^m \in I$  and  $f^p \in J$ . Thus  $f^{m+p} = f^m f^p \in I \cap J$ , so  $f \in \sqrt{I \cap J}$ .  $\square$

### EXERCISES FOR §3

1. Show that in  $\mathbb{Q}[x, y]$ , we have

$$\begin{aligned} \langle (x+y)^4(x^2+y)^2(x-5y) \rangle \cap \langle (x+y)(x^2+y)^3(x+3y) \rangle \\ = \langle (x+y)^4(x^2+y)^3(x-5y)(x+3y) \rangle. \end{aligned}$$

- Prove formula (1) for the least common multiple of two polynomials  $f$  and  $g$ .
- Prove assertion (i) of Proposition 13. That is, show that the intersection of two principal ideals is principal.
- Prove assertion (ii) of Proposition 13. That is, show that the least common multiple of two polynomials  $f$  and  $g$  in  $k[x_1, \dots, x_n]$  is the generator of the ideal  $\langle f \rangle \cap \langle g \rangle$ .
- Prove Proposition 14. That is, show that the least common multiple of two polynomials times the greatest common divisor of the same two polynomials is the product of the polynomials. Hint: Use the remarks following the statement of Proposition 14.
- Let  $I_1, \dots, I_r$  and  $J$  be ideals in  $k[x_1, \dots, x_n]$ . Show the following:
  - $(I_1 + I_2)J = I_1J + I_2J$ .
  - $(I_1 \cdots I_r)^m = I_1^m \cdots I_r^m$ .
- Let  $I$  and  $J$  be ideals in  $k[x_1, \dots, x_n]$ , where  $k$  is an arbitrary field. Prove the following:
  - If  $I^\ell \subset J$  for some integer  $\ell > 0$ , then  $\sqrt{I} \subset \sqrt{J}$ .
  - $\sqrt{I+J} = \sqrt{\sqrt{I} + \sqrt{J}}$ .
- Let

$$f = x^4 + x^3y + x^3z^2 - x^2y^2 + x^2yz^2 - xy^3 - xy^2z^2 - y^3z^2$$

and

$$g = x^4 + 2x^3z^2 - x^2y^2 + x^2z^4 - 2xy^2z^2 - y^2z^4.$$

- Use a computer algebra program to compute generators for  $\langle f \rangle \cap \langle g \rangle$  and  $\sqrt{\langle f \rangle \langle g \rangle}$ .
  - Use a computer algebra program to compute  $\text{GCD}(f, g)$ .
  - Let  $p = x^2 + xy + xz + yz$  and  $q = x^2 - xy - xz + yz$ . Use a computer algebra program to calculate  $\langle f, g \rangle \cap \langle p, q \rangle$ .
9. For an arbitrary field, show that  $\sqrt{IJ} = \sqrt{I \cap J}$ . Give an example to show that the product of radical ideals need not be radical. Give an example to show that  $\sqrt{IJ}$  can differ from  $\sqrt{I}\sqrt{J}$ .



10. If  $I$  is an ideal in  $k[x_1, \dots, x_n]$  and  $\langle f(t) \rangle$  is an ideal in  $k[t]$ , show that the ideal  $f(t)I$  defined in the text is the product of the ideal  $\tilde{I}$  generated by all elements of  $I$  in  $k[x_1, \dots, x_n, t]$  and the ideal  $\langle f(t) \rangle$  generated by  $f(t)$  in  $k[x_1, \dots, x_n, t]$ .
11. Two ideals  $I$  and  $J$  of  $k[x_1, \dots, x_n]$  are said to be *comaximal* if and only if  $I + J = k[x_1, \dots, x_n]$ .
- Show that if  $k = \mathbb{C}$ , then  $I$  and  $J$  are comaximal if and only if  $\mathbf{V}(I) \cap \mathbf{V}(J) = \emptyset$ . Give an example to show that this is false in general.
  - Show that if  $I$  and  $J$  are comaximal, then  $IJ = I \cap J$ .
  - Is the converse to part (b) true? That is, if  $IJ = I \cap J$ , does it necessarily follow that  $I$  and  $J$  are comaximal? Proof or counterexample?
  - If  $I$  and  $J$  are comaximal, show that  $I$  and  $J^2$  are comaximal. In fact, show that  $I^r$  and  $J^s$  are comaximal for all positive integers  $r$  and  $s$ .
  - Let  $I_1, \dots, I_r$  be ideals in  $k[x_1, \dots, x_n]$  and suppose that  $I_i$  and  $J_i = \bigcap_{j \neq i} I_j$  are comaximal for all  $i$ . Show that

$$I_1^m \cap \dots \cap I_r^m = (I_1 \dots I_r)^m = (I_1 \cap \dots \cap I_r)^m$$

for all positive integers  $m$ .

12. Let  $I, J$  be ideals in  $k[x_1, \dots, x_n]$  and suppose that  $I \subset \sqrt{J}$ . Show that  $I^m \subset J$  for some integer  $m > 0$ . Hint: You will need to use the Hilbert Basis Theorem.
13. Let  $A$  be an  $m \times n$  constant matrix and suppose that  $x = Ay$ , where we are thinking of  $x \in k^m$  and  $y \in k^n$  as column vectors. As in Exercise 9 of §1, define a map

$$\alpha_A : k[x_1, \dots, x_m] \rightarrow k[y_1, \dots, y_n]$$

by sending  $f \in k[x_1, \dots, x_m]$  to  $\alpha_A(f) \in k[y_1, \dots, y_n]$ , where  $\alpha_A(f)$  is the polynomial defined by  $\alpha_A(f)(y) = f(Ay)$ .

- Show that the set  $\{f \in k[x_1, \dots, x_m] : \alpha_A(f) = 0\}$  is an ideal in  $k[x_1, \dots, x_m]$ . [This set is called the *kernel* of  $\alpha_A$  and denoted  $\ker(\alpha_A)$ .]
  - If  $I$  is an ideal in  $k[x_1, \dots, x_m]$ , show that the set  $\alpha_A(I) = \{\alpha_A(f) : f \in I\}$  need not be an ideal in  $k[y_1, \dots, y_n]$ . [We will often write  $\langle \alpha_A(I) \rangle$  to denote the ideal in  $k[y_1, \dots, y_n]$  generated by the elements of  $\alpha_A(I)$ —it is called the *extension* of  $I$  to  $k[y_1, \dots, y_n]$ .]
  - Show that if  $I'$  is an ideal in  $k[y_1, \dots, y_n]$ , the set  $\alpha_A^{-1}(I') = \{f \in k[x_1, \dots, x_m] : \alpha_A(f) \in I'\}$  is an ideal in  $k[x_1, \dots, x_m]$  (often called the *contraction* of  $I'$ ).
14. Let  $A$  and  $\alpha_A$  be as above and let  $K = \ker(\alpha_A)$ . Let  $I$  and  $J$  be ideals in  $k[x_1, \dots, x_m]$ . Show that:
- $I \subset J$  implies  $\langle \alpha_A(I) \rangle \subset \langle \alpha_A(J) \rangle$ .
  - $\langle \alpha_A(I + J) \rangle = \langle \alpha_A(I) \rangle + \langle \alpha_A(J) \rangle$ .
  - $\langle \alpha_A(IJ) \rangle = \langle \alpha_A(I) \rangle \langle \alpha_A(J) \rangle$ .
  - $\langle \alpha_A(I \cap J) \rangle \subset \langle \alpha_A(I) \rangle \cap \langle \alpha_A(J) \rangle$ , with equality if  $I \supset K$  or  $J \supset K$  and  $\alpha_A$  is onto.
  - $\langle \alpha_A(\sqrt{I}) \rangle \subset \sqrt{\langle \alpha_A(I) \rangle}$  with equality if  $I \supset K$  and  $\alpha_A$  is onto.
15. Let  $A, \alpha_A$ , and  $K = \ker(\alpha_A)$  be as above. Let  $I'$  and  $J'$  be ideals in  $k[y_1, \dots, y_n]$ . Show that:
- $I' \subset J'$  implies  $\alpha_A^{-1}(I') \subset \alpha_A^{-1}(J')$ .
  - $\alpha_A^{-1}(I' + J') \supset \alpha_A^{-1}(I') + \alpha_A^{-1}(J')$ , with equality if  $\alpha_A$  is onto.
  - $\alpha_A^{-1}(I'J') \supset (\alpha_A^{-1}(I'))(\alpha_A^{-1}(J'))$ , with equality if  $\alpha_A$  is onto and the right-hand side contains  $K$ .
  - $\alpha_A^{-1}(I' \cap J') = \alpha_A^{-1}(I') \cap \alpha_A^{-1}(J')$ .
  - $\alpha_A^{-1}(\sqrt{I'}) = \sqrt{\alpha_A^{-1}(I')}$ .

## §4 Zariski Closure and Quotients of Ideals

We have already seen a number of examples of sets which are not varieties. Such sets arose very naturally in Chapter 3, where we saw that the projection of a variety need not be a variety, and in the exercises in Chapter 1, where we saw that the (set-theoretic) difference of varieties can fail to be a variety.

Whether or not a set  $S \subset k^n$  is an affine variety, the set

$$\mathbf{I}(S) = \{f \in k[x_1, \dots, x_n] : f(a) = 0 \text{ for all } a \in S\}$$

is an ideal in  $k[x_1, \dots, x_n]$  (check this!). In fact, it is radical. By the ideal–variety correspondence,  $\mathbf{V}(\mathbf{I}(S))$  is a variety. The following proposition states that this variety is the smallest variety that contains the set  $S$ .

**Proposition 1.** *If  $S \subset k^n$ , the affine variety  $\mathbf{V}(\mathbf{I}(S))$  is the smallest variety that contains  $S$  [in the sense that if  $W \subset k^n$  is any affine variety containing  $S$ , then  $\mathbf{V}(\mathbf{I}(S)) \subset W$ ].*

**Proof.** If  $W \supset S$ , then  $\mathbf{I}(W) \subset \mathbf{I}(S)$  (because  $\mathbf{I}$  is inclusion-reversing). But then  $\mathbf{V}(\mathbf{I}(W)) \supset \mathbf{V}(\mathbf{I}(S))$  (because  $\mathbf{V}$  is inclusion-reversing). Since  $W$  is an affine variety,  $\mathbf{V}(\mathbf{I}(W)) = W$  by Theorem 7 from §2, and the result follows.  $\square$

This proposition leads to the following definition.

**Definition 2.** *The Zariski closure of a subset of affine space is the smallest affine algebraic variety containing the set. If  $S \subset k^n$ , the Zariski closure of  $S$  is denoted  $\bar{S}$  and is equal to  $\mathbf{V}(\mathbf{I}(S))$ .*

We also note that  $\mathbf{I}(\bar{S}) = \mathbf{I}(S)$ . The inclusion  $\mathbf{I}(\bar{S}) \subset \mathbf{I}(S)$  follows from  $S \subset \bar{S}$ . Going the other way,  $f \in \mathbf{I}(S)$  implies  $S \subset \mathbf{V}(f)$ . Then  $S \subset \bar{S} \subset \mathbf{V}(f)$  by Definition 2, so that  $f \in \mathbf{I}(\bar{S})$ .

A natural example of Zariski closure is given by elimination ideals. We can now prove the first assertion of the Closure Theorem (Theorem 3 of Chapter 3, §2).

**Theorem 3.** *Let  $k$  be an algebraically closed field. Suppose  $V = \mathbf{V}(f_1, \dots, f_s) \subset k^n$ , and let  $\pi_l : k^n \rightarrow k^{n-l}$  be projection onto the last  $n-l$  components. If  $I_l$  is the  $l$ th elimination ideal  $I_l = \langle f_1, \dots, f_s \rangle \cap k[x_{l+1}, \dots, x_n]$ , then  $\mathbf{V}(I_l)$  is the Zariski closure of  $\pi_l(V)$ .*

**Proof.** In view of Proposition 1, we must show that  $\mathbf{V}(I_l) = \mathbf{V}(\mathbf{I}(\pi_l(V)))$ . By Lemma 1 of Chapter 3, §2, we have  $\pi_l(V) \subset \mathbf{V}(I_l)$ . Since  $\mathbf{V}(\mathbf{I}(\pi_l(V)))$  is the smallest variety containing  $\pi_l(V)$ , it follows immediately that  $\mathbf{V}(\mathbf{I}(\pi_l(V))) \subset \mathbf{V}(I_l)$ .

To get the opposite inclusion, suppose  $f \in \mathbf{I}(\pi_l(V))$ , i.e.,  $f(a_{l+1}, \dots, a_n) = 0$  for all  $(a_{l+1}, \dots, a_n) \in \pi_l(V)$ . Then, considered as an element of  $k[x_1, x_2, \dots, x_n]$ , we certainly have  $f(a_1, a_2, \dots, a_n) = 0$  for all  $(a_1, \dots, a_n) \in V$ . By Hilbert's Nullstellensatz,  $f^N \in \langle f_1, \dots, f_s \rangle$  for some integer  $N$ . Since  $f$  does not depend on  $x_1, \dots, x_l$ , neither

does  $f^N$ , and we have  $f^N \in \langle f_1, \dots, f_s \rangle \cap k[x_{l+1}, \dots, x_n] = I_l$ . Thus,  $f \in \sqrt{I_l}$ , which implies  $\mathbf{I}(\pi_l(V)) \subset \sqrt{I_l}$ . It follows that  $\mathbf{V}(I_l) = \mathbf{V}(\sqrt{I_l}) \subset \mathbf{V}(\mathbf{I}(\pi_l(V)))$ , and the theorem is proved.  $\square$

Another context in which we encountered sets which were not varieties was in taking the difference of varieties. For example, let  $W = \mathbf{V}(K)$  where  $K \subset k[x, y, z]$  is the ideal  $\langle xz, yz \rangle$  and  $V = \mathbf{V}(I)$  where  $I = \langle z \rangle$ . Then we have already seen that  $W$  is the union of the  $xy$ -plane and the  $z$ -axis. Since  $V$  is the  $xy$ -plane,  $W - V$  is the  $z$ -axis with the origin removed (because the origin also belongs to the  $xy$ -plane). We have seen in Chapter 1 that this is not a variety. The  $z$ -axis  $[= \mathbf{V}(x, y)]$  is the smallest variety containing  $W - V$ .

We could ask if there is a general way to compute the ideal corresponding to the Zariski closure  $\overline{W - V}$  of the difference of two varieties  $W$  and  $V$ . The answer is affirmative, but it involves a new algebraic construction on ideals.

To see what the construction involves let us first note the following.

**Proposition 4.** *If  $V$  and  $W$  are varieties with  $V \subset W$ , then  $W = V \cup \overline{(W - V)}$ .*

**Proof.** Since  $W$  contains  $W - V$  and  $W$  is a variety, it must be the case that the smallest variety containing  $W - V$  is contained in  $W$ . Hence,  $\overline{W - V} \subset W$ . Since  $V \subset W$  by hypothesis, we must have  $V \cup \overline{(W - V)} \subset W$ .

To get the reverse containment, note that  $V \subset W$  implies  $W = V \cup (W - V)$ . Since  $W - V \subset \overline{W - V}$ , the desired inclusion  $W \subset V \cup \overline{W - V}$  follows immediately.  $\square$

Our next task is to study the ideal-theoretic analogue of  $\overline{W - V}$ . We start with the following definition.

**Definition 5.** *If  $I, J$  are ideals in  $k[x_1, \dots, x_n]$ , then  $I : J$  is the set*

$$\{f \in k[x_1, \dots, x_n] : fg \in I \text{ for all } g \in J\}$$

*and is called the **ideal quotient** (or **colon ideal**) of  $I$  by  $J$ .*

So, for example, in  $k[x, y, z]$  we have

$$\begin{aligned} \langle xz, yz \rangle : \langle z \rangle &= \{f \in k[x, y, z] : f \cdot z \in \langle xz, yz \rangle\} \\ &= \{f \in k[x, y, z] : f \cdot z = Axz + Byz\} \\ &= \{f \in k[x, y, z] : f = Ax + By\} \\ &= \langle x, y \rangle. \end{aligned}$$

**Proposition 6.** *If  $I, J$  are ideals in  $k[x_1, \dots, x_n]$ , then  $I : J$  is an ideal in  $k[x_1, \dots, x_n]$  and  $I : J$  contains  $I$ .*

**Proof.** To show  $I : J$  contains  $I$ , note that because  $I$  is an ideal, if  $f \in I$ , then  $fg \in I$  for all  $g \in k[x_1, \dots, x_n]$  and, hence, certainly  $fg \in I$  for all  $g \in J$ . To show that  $I : J$  is an

ideal, first note that  $0 \in I : J$  because  $0 \in I$ . Let  $f_1, f_2 \in I : J$ . Then  $f_1g$  and  $f_2g$  are in  $I$  for all  $g \in J$ . Since  $I$  is an ideal  $(f_1 + f_2)g = f_1g + f_2g \in I$  for all  $g \in J$ . Thus,  $f_1 + f_2 \in I : J$ . To check closure under multiplication is equally straightforward: if  $f \in I : J$  and  $h \in k[x_1, \dots, x_n]$ , then  $fg \in I$  and, since  $I$  is an ideal,  $hfg \in I$  for all  $g \in J$ , which means that  $hf \in I : J$ .  $\square$

The following theorem shows that the ideal quotient is indeed the algebraic analogue of the Zariski closure of a difference of varieties.

**Theorem 7.** *Let  $I$  and  $J$  be ideals in  $k[x_1, \dots, x_n]$ . Then*

$$\mathbf{V}(I : J) \supset \overline{\mathbf{V}(I) - \mathbf{V}(J)}.$$

*If, in addition,  $k$  is algebraically closed and  $I$  is a radical ideal, then*

$$\mathbf{V}(I : J) = \overline{\mathbf{V}(I) - \mathbf{V}(J)}.$$

**Proof.** We claim that  $I : J \subset \mathbf{I}(\mathbf{V}(I) - \mathbf{V}(J))$ . For suppose that  $f \in I : J$  and  $x \in \mathbf{V}(I) - \mathbf{V}(J)$ . Then  $fg \in I$  for all  $g \in J$ . Since  $x \in \mathbf{V}(I)$ , we have  $f(x)g(x) = 0$  for all  $g \in J$ . Since  $x \notin \mathbf{V}(J)$ , there is some  $g \in J$  such that  $g(x) \neq 0$ . Hence,  $f(x) = 0$  for any  $x \in \mathbf{V}(I) - \mathbf{V}(J)$ . Hence,  $f \in \mathbf{I}(\mathbf{V}(I) - \mathbf{V}(J))$  which proves the claim. Since  $\mathbf{V}$  is inclusion-reversing, we have  $\mathbf{V}(I : J) \supset \mathbf{V}(\mathbf{I}(\mathbf{V}(I) - \mathbf{V}(J)))$ . This proves the first part of the theorem.

Now, suppose that  $k$  is algebraically closed and that  $I = \sqrt{I}$ . Let  $x \in \mathbf{V}(I : J)$ . Equivalently,

$$(1) \quad \text{if } hg \in I \text{ for all } g \in J, \text{ then } h(x) = 0.$$

Now let  $h \in \mathbf{I}(\mathbf{V}(I) - \mathbf{V}(J))$ . If  $g \in J$ , then  $hg$  vanishes on  $\mathbf{V}(I)$  because  $h$  vanishes on  $\mathbf{V}(I) - \mathbf{V}(J)$  and  $g$  on  $\mathbf{V}(J)$ . Thus, by the Nullstellensatz,  $hg \in \sqrt{I}$ . By assumption,  $I = \sqrt{I}$ , and hence,  $hg \in I$  for all  $g \in J$ . By (1), we have  $h(x) = 0$ . Thus,  $x \in \mathbf{V}(\mathbf{I}(\mathbf{V}(I) - \mathbf{V}(J)))$ . This establishes that

$$\mathbf{V}(I : J) \subset \mathbf{V}(\mathbf{I}(\mathbf{V}(I) - \mathbf{V}(J))),$$

and completes the proof.  $\square$

The proof of Theorem 7 yields the following corollary that holds over any field.

**Corollary 8.** *Let  $V$  and  $W$  be varieties in  $k^n$ . Then*

$$\mathbf{I}(V) : \mathbf{I}(W) = \mathbf{I}(V - W).$$

**Proof.** In Theorem 7, we showed that  $I : J \subset \mathbf{I}(\mathbf{V}(I) - \mathbf{V}(J))$ . If we apply this to  $I = \mathbf{I}(V)$  and  $J = \mathbf{I}(W)$ , we obtain  $\mathbf{I}(V) : \mathbf{I}(W) \subset \mathbf{I}(V - W)$ . The opposite inclusion follows from the definition of ideal quotient.  $\square$

The following proposition takes care of some of the more obvious properties of ideal quotients. The reader is urged to translate the statements into terms of varieties (upon which they become completely obvious).

**Proposition 9.** *Let  $I, J,$  and  $K$  be ideals in  $k[x_1, \dots, x_n]$ . Then:*

- (i)  $I : k[x_1, \dots, x_n] = I.$
- (ii)  $IJ \subset K$  if and only if  $I \subset K : J.$
- (iii)  $J \subset I$  if and only if  $I : J = k[x_1, \dots, x_n].$

**Proof.** The proof is left as an exercise. □

The following useful proposition relates the quotient operation to the other operations we have defined:

**Proposition 10.** *Let  $I, I_i, J, J_i,$  and  $K$  be ideals in  $k[x_1, \dots, x_n]$  for  $1 \leq i \leq r.$  Then*

$$(2) \quad \left( \bigcap_{i=1}^r I_i \right) : J = \bigcap_{i=1}^r (I_i : J),$$

$$(3) \quad I : \left( \sum_{i=1}^r J_i \right) = \bigcap_{i=1}^r (I : J_i),$$

$$(4) \quad (I : J) : K = I : JK.$$

**Proof.** We again leave the (straightforward) proofs to the reader. □

If  $f$  is a polynomial and  $I$  an ideal, we often write  $I : f$  instead of  $I : \langle f \rangle.$  Note that a special case of (3) is that

$$(5) \quad I : \langle f_1, f_2, \dots, f_r \rangle = \bigcap_{i=1}^r (I : f_i).$$

We now turn to the question of how to compute generators of the ideal quotient  $I : J$  given generators of  $I$  and  $J.$  The following observation is the key step.

**Theorem 11.** *Let  $I$  be an ideal and  $g$  an element of  $k[x_1, \dots, x_n].$  If  $\{h_1, \dots, h_p\}$  is a basis of the ideal  $I \cap \langle g \rangle,$  then  $\{h_1/g, \dots, h_p/g\}$  is a basis of  $I : \langle g \rangle.$*

**Proof.** If  $a \in \langle g \rangle,$  then  $a = bg$  for some polynomial  $b.$  Thus, if  $f \in \langle h_1/g, \dots, h_p/g \rangle,$  then

$$af = bgf \in \langle h_1, \dots, h_p \rangle = I \cap \langle g \rangle \subset I.$$

Thus,  $f \in I : \langle g \rangle.$  Conversely, suppose  $f \in I : \langle g \rangle.$  Then  $fg \in I.$  Since  $fg \in \langle g \rangle,$  we have  $fg \in I \cap \langle g \rangle.$  If  $I \cap \langle g \rangle = \langle h_1, \dots, h_p \rangle,$  this means  $fg = \sum r_i h_i$  for some

polynomials  $r_i$ . Since each  $h_i \in \langle g \rangle$ , each  $h_i/g$  is a polynomial, and we conclude that  $f = \sum r_i(h_i/g)$ , whence  $f \in \langle h_1/g, \dots, h_p/g \rangle$ .  $\square$

This theorem, together with our procedure for computing intersections of ideals and equation (5), immediately leads to an **algorithm for computing a basis of an ideal quotient**. Namely, given  $I = \langle f_1, \dots, f_r \rangle$  and  $J = \langle g_1, \dots, g_s \rangle = \langle g_1 \rangle + \dots + \langle g_s \rangle$ , to compute a basis of  $I : J$ , we first compute a basis for  $I : \langle g_i \rangle$  for each  $i$ . In view of Theorem 11, we first compute a basis of  $\langle f_1, \dots, f_r \rangle \cap \langle g_i \rangle$ . Recall that we do this by finding a Groebner basis of  $\langle tf_1, \dots, tf_r, (1-t)g_i \rangle$  with respect to a lex order in which  $t$  precedes all the  $x_i$  and retaining all basis elements which do not depend on  $t$  (this is our algorithm for computing ideal intersections). Using the division algorithm, we divide each of these elements by  $g_i$  to get a basis for  $I : \langle g_i \rangle$ . Finally, we compute a basis for  $I : J$  by applying the intersection algorithm  $s - 1$  times, computing first a basis for  $I : \langle g_1, g_2 \rangle = (I : \langle g_1 \rangle) \cap (I : \langle g_2 \rangle)$ , then a basis for  $I : \langle g_1, g_2, g_3 \rangle = (I : \langle g_1, g_2 \rangle) \cap (I : \langle g_3 \rangle)$ , and so on.

**EXERCISES FOR §4**

1. Find the Zariski closure of the following sets:
  - a. The projection of the hyperbola  $\mathbf{V}(xy - 1)$  in  $\mathbb{R}^2$  onto the  $x$ -axis.
  - b. The boundary of the first quadrant in  $\mathbb{R}^2$ .
  - c. The set  $\{(x, y) \in \mathbb{R}^2 : x^2 + y^2 \leq 4\}$ .
2. Let  $f = (x + y)^2(x - y)(x + z^2)$  and  $g = (x + z^2)^3(x - y)(z + y)$ . Compute generators for  $\langle f \rangle : \langle g \rangle$ .
3. Let  $I$  and  $J$  be ideals. Show that if  $I$  is radical, then  $I : J$  is radical and  $I : J = I : \sqrt{J}$ .
4. Give an example to show that the hypothesis that  $I$  is radical is necessary for the conclusion of Theorem 7 to hold. Hint: Examine the proof to see where we used this hypothesis.
5. Prove Proposition 9 and find geometric interpretations of each of its assertions.
6. Prove Proposition 10 and find geometric interpretations of each of its assertions.
7. Let  $A$  be an  $m \times n$  constant matrix and suppose that  $x = Ay$  where we are thinking of  $x \in k^m$  and  $y \in k^n$  as column vectors. As in Exercises 9 of §1 and 13 of §3, define a map

$$\alpha_A : k[x_1, \dots, x_m] \longrightarrow k[y_1, \dots, y_n]$$

by sending  $f \in k[x_1, \dots, x_m]$  to  $\alpha_A(f) \in k[y_1, \dots, y_n]$ , where  $\alpha_A(f)$  is the polynomial defined by  $\alpha_A(f)(y) = f(Ay)$ .

- a. Show that  $\alpha_A(I : J) \subset \alpha_A(I) : \alpha_A(J)$  with equality if  $I \supset \ker(\alpha_A)$  and  $\alpha_A$  is onto.
- b. Show that  $\alpha_A^{-1}(I' : J') = \alpha_A^{-1}(I') : \alpha_A^{-1}(J')$  when  $\alpha_A$  is onto.
8. Let  $I \subset k[x_1, \dots, x_n]$  be an ideal, and fix  $f \in k[x_1, \dots, x_n]$ . Then the *saturation* of  $I$  with respect to  $f$  is the set

$$I : f^\infty = \{g \in k[x_1, \dots, x_n] : f^m g \in I \text{ for some } m > 0\}.$$

- a. Prove that  $I : f^\infty$  is an ideal.
- b. Prove that we have the ascending chain of ideals  $I : f \subset I : f^2 \subset I : f^3 \subset \dots$ .
- c. By part b and the Ascending Chain Condition (Theorem 7 of Chapter 2, §5), we have  $I : f^N = I : f^{N+1} = \dots$  for some integer  $N$ . Prove that  $I : f^\infty = I : f^N$ .

- d. Prove that  $I : f^\infty = I : f^m$  if and only if  $I : f^m = I : f^{m+1}$ .  
 e. Use part d to describe an algorithm for computing the saturation  $I : f^\infty$ .  
 9. As in Exercise 8, let  $I = \langle f_1, \dots, f_s \rangle \subset k[x_1, \dots, x_n]$  and fix  $f \in k[x_1, \dots, x_n]$ . If  $y$  is a new variable, set

$$\tilde{I} = \langle f_1, \dots, f_s, 1 - fy \rangle \subset k[x_1, \dots, x_n, y].$$

- a. Prove that  $I : f^\infty = \tilde{I} \cap k[x_1, \dots, x_n]$ . Hint: See the proof of Proposition 8 of §2.  
 b. Use the result of part a to describe a second algorithm for computing  $I : f^\infty$ .  
 10. Using the notation of Exercise 8, prove that  $I : f^\infty = k[x_1, \dots, x_n]$  if and only if  $f \in \sqrt{I}$ . Note that Proposition 8 of §2 is an immediate corollary of Exercises 9 and 10.

## §5 Irreducible Varieties and Prime Ideals

We have already seen that the union of two varieties is a variety. For example, in Chapter 1 and in the last section, we considered  $\mathbf{V}(xz, yz)$ , which is the union of a line and a plane. Intuitively, it is natural to think of the line and the plane as “more fundamental” than  $\mathbf{V}(xz, yz)$ . Intuition also tells us that a line or a plane are “irreducible” or “indecomposable” in some sense: they do not obviously seem to be a union of finitely many simpler varieties. We formalize this notion as follows.

**Definition 1.** An affine variety  $V \subset k^n$  is **irreducible** if whenever  $V$  is written in the form  $V = V_1 \cup V_2$ , where  $V_1$  and  $V_2$  are affine varieties, then either  $V_1 = V$  or  $V_2 = V$ .

Thus,  $\mathbf{V}(xz, yz)$  is not an irreducible variety. On the other hand, it is not completely clear when a variety is irreducible. If this definition is to correspond to our geometric intuition, it is clear that a point, a line, and a plane ought to be irreducible. For that matter, the twisted cubic  $\mathbf{V}(y - x^2, z - x^3)$  in  $\mathbb{R}^3$  appears to be irreducible. But how do we prove this? The key is to capture this notion algebraically: if we can characterize ideals which correspond to irreducible varieties, then perhaps we stand a chance of establishing whether a variety is irreducible

The following notion turns out to be the right one.

**Definition 2.** An ideal  $I \subset k[x_1, \dots, x_n]$  is **prime** if whenever  $f, g \in k[x_1, \dots, x_n]$  and  $fg \in I$ , then either  $f \in I$  or  $g \in I$ .

If we have set things up right, an irreducible variety will correspond to a prime ideal and conversely. The following theorem assures us that this is indeed the case.

**Proposition 3.** Let  $V \subset k^n$  be an affine variety. Then  $V$  is irreducible if and only if  $\mathbf{I}(V)$  is a prime ideal.

**Proof.** First, assume that  $V$  is irreducible and let  $fg \in \mathbf{I}(V)$ . Set  $V_1 = V \cap \mathbf{V}(f)$  and  $V_2 = V \cap \mathbf{V}(g)$ ; these are affine varieties because an intersection of affine varieties is

a variety. Then  $fg \in \mathbf{I}(V)$  easily implies that  $V = V_1 \cup V_2$ . Since  $V$  is irreducible, we have either  $V = V_1$  or  $V = V_2$ . Say the former holds, so that  $V = V_1 = V \cap \mathbf{V}(f)$ . This implies that  $f$  vanishes on  $V$ , so that  $f \in \mathbf{I}(V)$ . Thus,  $\mathbf{I}(V)$  is prime.

Next, assume that  $\mathbf{I}(V)$  is prime and let  $V = V_1 \cup V_2$ . Suppose that  $V \neq V_1$ . We claim that  $\mathbf{I}(V) = \mathbf{I}(V_2)$ . To prove this, note that  $\mathbf{I}(V) \subset \mathbf{I}(V_2)$  since  $V_2 \subset V$ . For the opposite inclusion, first note that  $\mathbf{I}(V) \subsetneq \mathbf{I}(V_1)$  since  $V_1 \subsetneq V$ . Thus, we can pick  $f \in \mathbf{I}(V_1) - \mathbf{I}(V)$ . Now take any  $g \in \mathbf{I}(V_2)$ . Since  $V = V_1 \cup V_2$ , it follows that  $fg$  vanishes on  $V$ , and, hence,  $fg \in \mathbf{I}(V)$ . But  $\mathbf{I}(V)$  is prime, so that  $f$  or  $g$  lies in  $\mathbf{I}(V)$ . We know that  $f \notin \mathbf{I}(V)$  and, thus,  $g \in \mathbf{I}(V)$ . This proves  $\mathbf{I}(V) = \mathbf{I}(V_2)$ , whence  $V = V_2$  because  $\mathbf{I}$  is one-to-one. Thus,  $V$  is an irreducible variety.  $\square$

It is an easy exercise to show that every prime ideal is radical. Then, using the ideal–variety correspondence between radical ideals and varieties, we get the following corollary of Proposition 3.

**Corollary 4.** *When  $k$  is algebraically closed, the functions  $\mathbf{I}$  and  $\mathbf{V}$  induce a one-to-one correspondence between irreducible varieties in  $k^n$  and prime ideals in  $k[x_1, \dots, x_n]$ .*

As an example of how to use Proposition 3, let us prove that the ideal  $\mathbf{I}(V)$  of the twisted cubic is prime. Suppose that  $fg \in \mathbf{I}(V)$ . Since the curve is parametrized by  $(t, t^2, t^3)$ , it follows that, for all  $t$ ,

$$f(t, t^2, t^3)g(t, t^2, t^3) = 0.$$

This implies that  $f(t, t^2, t^3)$  or  $g(t, t^2, t^3)$  must be the zero polynomial, so that  $f$  or  $g$  vanishes on  $V$ . Hence,  $f$  or  $g$  lies in  $\mathbf{I}(V)$ , proving that  $\mathbf{I}(V)$  is a prime ideal. By the proposition, the twisted cubic is an irreducible variety in  $\mathbf{R}^3$ . One proves that a straight line is irreducible in the same way: first parametrize it, then apply the above argument.

In fact, the above argument holds much more generally.

**Proposition 5.** *If  $k$  is an infinite field and  $V \subset k^n$  is a variety defined parametrically*

$$\begin{aligned} x_1 &= f_1(t_1, \dots, t_m), \\ &\vdots \\ x_n &= f_n(t_1, \dots, t_m), \end{aligned}$$

where  $f_1, \dots, f_n$  are polynomials in  $k[t_1, \dots, t_m]$ , then  $V$  is irreducible.

**Proof.** As in §3 of Chapter 3, we let  $F : k^m \rightarrow k^n$  be defined by

$$F(t_1, \dots, t_m) = (f_1(t_1, \dots, t_m), \dots, f_n(t_1, \dots, t_m)).$$

Saying that  $V$  is defined parametrically by the above equations means that  $V$  is the Zariski closure of  $F(k^m)$ . In particular,  $\mathbf{I}(V) = \mathbf{I}(F(k^m))$ .



For any polynomial  $g \in k[x_1, \dots, x_n]$ , the function  $g \circ F$  is a polynomial in  $k[t_1, \dots, t_m]$ . In fact,  $g \circ F$  is the polynomial obtained by “plugging the polynomials  $f_1, \dots, f_n$  into  $g$ ”:

$$g \circ F = g(f_1(t_1, \dots, t_m), \dots, f_n(t_1, \dots, t_m)).$$

Because  $k$  is infinite,  $\mathbf{I}(V) = \mathbf{I}(F(k^m))$  is the set of polynomials in  $k[x_1, \dots, x_n]$  whose composition with  $F$  is the zero polynomial in  $k[t_1, \dots, t_m]$ :

$$\mathbf{I}(V) = \{g \in k[x_1, \dots, x_n] : g \circ F = 0\}.$$

Now suppose that  $gh \in \mathbf{I}(V)$ . Then  $(gh) \circ F = (g \circ F)(h \circ F) = 0$ . (Make sure you understand this.) But, if the product of two polynomials in  $k[t_1, \dots, t_m]$  is the zero polynomial, one of them must be the zero polynomial. Hence, either  $g \circ F = 0$  or  $h \circ F = 0$ . This means that either  $g \in \mathbf{I}(V)$  or  $h \in \mathbf{I}(V)$ . This shows that  $\mathbf{I}(V)$  is a prime ideal and, therefore, that  $V$  is irreducible.  $\square$

With a little care, the above argument extends still further to show that any variety defined by a *rational* parametrization is irreducible.

**Proposition 6.** *If  $k$  is an infinite field and  $V$  is a variety defined by the rational parametrization*

$$\begin{aligned} x_1 &= \frac{f_1(t_1, \dots, t_m)}{g_1(t_1, \dots, t_m)}, \\ &\vdots \\ x_n &= \frac{f_n(t_1, \dots, t_m)}{g_n(t_1, \dots, t_m)}, \end{aligned}$$

where  $f_1, \dots, f_n, g_1, \dots, g_n \in k[t_1, \dots, t_m]$ , then  $V$  is irreducible.

**Proof.** Set  $W = \mathbf{V}(g_1 g_2 \cdots g_n)$  and let  $F : k^m - W \rightarrow k^n$  defined by

$$F(t_1, \dots, t_m) = \left( \frac{f_1(t_1, \dots, t_m)}{g_1(t_1, \dots, t_m)}, \dots, \frac{f_n(t_1, \dots, t_m)}{g_n(t_1, \dots, t_m)} \right).$$

Then  $V$  is the Zariski closure of  $F(k^m - W)$ , which implies that  $\mathbf{I}(V)$  is the set of  $h \in k[x_1, \dots, x_n]$  such that the function  $h \circ F$  is zero for all  $(t_1, \dots, t_m) \in k^m - W$ . The difficulty is that  $h \circ F$  need not be a polynomial, and we, thus, cannot directly apply the argument in the latter part of the proof of Proposition 5.

We can get around this difficulty as follows. Let  $h \in k[x_1, \dots, x_n]$ . Since

$$g_1(t_1, \dots, t_m)g_2(t_1, \dots, t_m) \cdots g_n(t_1, \dots, t_m) \neq 0$$

for any  $(t_1, \dots, t_m) \in k^m - W$ , the function  $(g_1 g_2 \cdots g_n)^N (h \circ F)$  is equal to zero at precisely those values of  $(t_1, \dots, t_m) \in k^m - W$  for which  $h \circ F$  is equal to zero. Moreover,

if we let  $N$  be the total degree of  $h \in k[x_1, \dots, x_n]$ , then we leave it as an exercise to show that  $(g_1 g_2 \cdots g_n)^N (h \circ F)$  is a polynomial in  $k[t_1, \dots, t_m]$ . We deduce that  $h \in \mathbf{I}(V)$  if and only if  $(g_1 g_2 \cdots g_n)^N (h \circ F)$  is zero for all  $t \in k^m - W$ . But, by Exercise 11 of Chapter 3, §3, this happens if and only if  $(g_1 g_2 \cdots g_n)^N (h \circ F)$  is the zero polynomial in  $k[t_1, \dots, t_m]$ . Thus, we have shown that

$$h \in \mathbf{I}(V) \quad \text{if and only if} \quad (g_1 g_2 \cdots g_n)^N (h \circ F) = 0 \in k[t_1, \dots, t_m].$$

Now, we can continue with our proof that  $\mathbf{I}(V)$  is prime. Suppose  $p, q \in k[x_1, \dots, x_n]$  are such that  $p \cdot q \in \mathbf{I}(V)$ . If the total degrees of  $p$  and  $q$  are  $M$  and  $N$ , respectively, then the total degree of  $p \cdot q$  is  $M + N$ . Thus,  $(g_1 g_2 \cdots g_n)^{M+N} (p \circ F) \cdot (q \circ F) = 0$ . But the former is a product of the polynomials  $(g_1 g_2 \cdots g_n)^M (p \circ F)$  and  $(g_1 g_2 \cdots g_n)^N (q \circ F)$  in  $k[t_1, \dots, t_m]$ . Hence one of them must be the zero polynomial. In particular, either  $p \in \mathbf{I}(V)$  or  $q \in \mathbf{I}(V)$ . This shows that  $\mathbf{I}(V)$  is a prime ideal and, therefore, that  $V$  is an irreducible variety.  $\square$

The simplest variety in  $k^n$  given by a parametrization is a single point  $\{(a_1, \dots, a_n)\}$ . In the notation of Proposition 5, it is given by the parametrization in which each  $f_i$  is the constant polynomial  $f_i(t_1, \dots, t_m) = a_i$ ,  $1 \leq i \leq n$ . It is clearly irreducible and it is easy to check that  $\mathbf{I}(\{(a_1, \dots, a_n)\}) = \langle x_1 - a_1, \dots, x_n - a_n \rangle$  (see Exercise 7), which implies that the latter is prime. The ideal  $\langle x_1 - a_1, \dots, x_n - a_n \rangle$  has another distinctive property: it is maximal in the sense that the only ideal which strictly contains it is the whole ring  $k[x_1, \dots, x_n]$ . Such ideals are important enough to merit special attention.

**Definition 7.** An ideal  $I \subset k[x_1, \dots, x_n]$  is said to be **maximal** if  $I \neq k[x_1, \dots, x_n]$  and any ideal  $J$  containing  $I$  is such that either  $J = I$  or  $J = k[x_1, \dots, x_n]$ .

In order to streamline statements, we make the following definition.

**Definition 8.** An ideal  $I \subset k[x_1, \dots, x_n]$  is called **proper** if  $I$  is not equal to  $k[x_1, \dots, x_n]$ .

Thus, an ideal is maximal if it is proper and no other proper ideal strictly contains it. We now show that any ideal of the form  $\langle x_1 - a_1, \dots, x_n - a_n \rangle$  is maximal.

**Proposition 9.** If  $k$  is any field, an ideal  $I \subset k[x_1, \dots, x_n]$  of the form

$$I = \langle x_1 - a_1, \dots, x_n - a_n \rangle,$$

where  $a_1, \dots, a_n \in k$ , is maximal.

**Proof.** Suppose that  $J$  is some ideal strictly containing  $I$ . Then there must exist  $f \in J$  such that  $f \notin I$ . We can use the division algorithm to write  $f$  as  $A_1(x_1 - a_1) + \cdots + A_n(x_n - a_n) + b$  for some  $b \in k$ . Since  $A_1(x_1 - a_1) + \cdots + A_n(x_n - a_n) \in I$  and

$f \notin I$ , we must have  $b \neq 0$ . However, since  $f \in J$  and since  $A_1(x_1 - a_1) + \cdots + A_n(x_n - a_n) \in I \subset J$ , we also have

$$b = f - (A_1(x_1 - a_1) + \cdots + A_n(x_n - a_n)) \in J.$$

Since  $b$  is nonzero,  $1 = 1/b \cdot b \in J$ . So  $J = k[x_1, \dots, x_n]$ .  $\square$

Since

$$\mathbf{V}(x_1 - a_1, \dots, x_n - a_n) = \{(a_1, \dots, a_n)\},$$

every point  $(a_1, \dots, a_n) \in k^n$  corresponds to a maximal ideal of  $k[x_1, \dots, x_n]$ , namely  $\langle x_1 - a_1, \dots, x_n - a_n \rangle$ . The converse does not hold if  $k$  is not algebraically closed. In the exercises, we ask you to show that  $\langle x^2 + 1 \rangle$  is maximal in  $\mathbb{R}[x]$ . The latter does not correspond to a point of  $\mathbb{R}$ . The following result, however, holds in any polynomial ring.

**Proposition 10.** *If  $k$  is any field, a maximal ideal in  $k[x_1, \dots, x_n]$  is prime.*

**Proof.** Suppose that  $I$  is a proper ideal which is not prime and let  $fg \in I$ , where  $f \notin I$  and  $g \notin I$ . Consider the ideal  $\langle f \rangle + I$ . This ideal strictly contains  $I$  because  $f \notin I$ . Moreover, if we were to have  $\langle f \rangle + I = k[x_1, \dots, x_n]$ , then  $1 = cf + h$  for some polynomial  $c$  and some  $h \in I$ . Multiplying through by  $g$  would give  $g = cfg + hg \in I$  which would contradict our choice of  $g$ . Thus,  $I + \langle f \rangle$  is a proper ideal containing  $I$ , so that  $I$  is not maximal.  $\square$

Note that Propositions 9 and 10 together imply that  $\langle x_1 - a_1, \dots, x_n - a_n \rangle$  is prime in  $k[x_1, \dots, x_n]$  even if  $k$  is not infinite. Over an algebraically closed field, it turns out that every maximal ideal corresponds to some point of  $k^n$ .

**Theorem 11.** *If  $k$  is an algebraically closed field, then every maximal ideal of  $k[x_1, \dots, x_n]$  is of the form  $\langle x_1 - a_1, \dots, x_n - a_n \rangle$  for some  $a_1, \dots, a_n \in k$ .*

**Proof.** Let  $I \subset k[x_1, \dots, x_n]$  be maximal. Since  $I \neq k[x_1, \dots, x_n]$ , we have  $\mathbf{V}(I) \neq \emptyset$  by the Weak Nullstellensatz (Theorem 1 of §1). Hence, there is some point  $(a_1, \dots, a_n) \in \mathbf{V}(I)$ . This means that every  $f \in I$  vanishes at  $(a_1, \dots, a_n)$ , so that  $f \in \mathbf{I}(\{(a_1, \dots, a_n)\})$ . Thus, we can write

$$I \subset \mathbf{I}(\{(a_1, \dots, a_n)\}).$$

We have already observed that  $\mathbf{I}(\{(a_1, \dots, a_n)\}) = \langle x_1 - a_1, \dots, x_n - a_n \rangle$  (see Exercise 7), and, thus, the above inclusion becomes

$$I \subset \langle x_1 - a_1, \dots, x_n - a_n \rangle \subsetneq k[x_1, \dots, x_n].$$

Since  $I$  is maximal, it follows that  $I = \langle x_1 - a_1, \dots, x_n - a_n \rangle$ .  $\square$

Note the proof of Theorem 11 uses the Weak Nullstellensatz. It is not difficult to see that it is, in fact, equivalent to the Weak Nullstellensatz.

We have the following easy corollary of Theorem 11.

**Corollary 12.** *If  $k$  is an algebraically closed field, then there is a one-to-one correspondence between points of  $k^n$  and maximal ideals of  $k[x_1, \dots, x_n]$ .*

Thus, we have extended our algebra–geometry dictionary. Over an algebraically closed field, every nonempty irreducible variety corresponds to a proper prime ideal, and conversely. Every point corresponds to a maximal ideal, and conversely.

### EXERCISES FOR §5

- If  $h \in k[x_1, \dots, x_n]$  has total degree  $N$  and if  $F$  is as in Proposition 6, show that  $(g_1 g_2 \dots g_n)^N (h \circ F)$  is a polynomial in  $k[t_1, \dots, t_m]$ .
- Show that a prime ideal is radical.
- Show that an ideal  $I$  is prime if and only if for any ideals  $J$  and  $K$  such that  $JK \subset I$ , either  $J \subset I$  or  $K \subset I$ .
- Let  $I_1, \dots, I_n$  be ideals and  $P$  a prime ideal containing  $\bigcap_{i=1}^n I_i$ . Then prove that  $P \supset I_i$  for some  $i$ . Further, if  $P = \bigcap_{i=1}^n I_i$ , show that  $P = I_i$  for some  $i$ .
- Express  $f = x^2 z - 6y^4 + 2xy^3 z$  in the form  $f = f_1(x, y, z)(x + 3) + f_2(x, y, z)(y - 1) + f_3(x, y, z)(z - 2)$  for some  $f_1, f_2, f_3 \in k[x, y, z]$ .
- Let  $k$  be an infinite field.
  - Show that any straight line in  $k^n$  is irreducible.
  - Prove that any linear subspace of  $k^n$  is irreducible. Hint: Parametrize and use Proposition 5.
- Show that
 
$$\mathbf{I}(\{(a_1, \dots, a_n)\}) = \langle x_1 - a_1, \dots, x_n - a_n \rangle.$$
- Show the following:
  - $\langle x^2 + 1 \rangle$  is maximal in  $\mathbb{R}[x]$ .
  - If  $I \subset \mathbb{R}[x_1, \dots, x_n]$  is maximal, show that  $\mathbf{V}(I)$  is either empty or a point in  $\mathbb{R}^n$ . Hint: Examine the proof of Theorem 11.
  - Give an example of a maximal ideal  $I$  in  $\mathbb{R}[x_1, \dots, x_n]$  for which  $\mathbf{V}(I) = \emptyset$ . Hint: Consider the ideal  $\langle x_1^2 + 1, x_2, \dots, x_n \rangle$ .
- Suppose that  $k$  is a field which is not algebraically closed.
  - Show that if  $I \subset k[x_1, \dots, x_n]$  is maximal, then  $\mathbf{V}(I)$  is either empty or a point in  $k^n$ . Hint: Examine the proof of Theorem 11.
  - Show that there exists a maximal ideal  $I$  in  $k[x_1, \dots, x_n]$  for which  $\mathbf{V}(I) = \emptyset$ . Hint: See the previous exercise.
  - Conclude that if  $k$  is not algebraically closed, there is always a maximal ideal of  $k[x_1, \dots, x_n]$  which is not of the form  $\langle x_1 - a_1, \dots, x_n - a_n \rangle$ .
- Prove that Theorem 11 implies the Weak Nullstellensatz.
- If  $f \in \mathbb{C}[x_1, \dots, x_n]$  is irreducible, then  $\mathbf{V}(f)$  is irreducible.
- Prove that if  $I$  is any proper ideal in  $\mathbb{C}[x_1, \dots, x_n]$ , then  $\sqrt{I}$  is the intersection of all maximal ideals containing  $I$ . Hint: Use Theorem 11.

## §6 Decomposition of a Variety into Irreducibles

In the last section, we saw that irreducible varieties arise naturally in many contexts. It is natural to ask whether an arbitrary variety can be built up out of irreducibles. In this section, we explore this and related questions.

We begin by translating the *Ascending Chain Condition* (ACC) for ideals (see §5 of Chapter 2) into the language of varieties.

**Proposition 1 (The Descending Chain Condition).** *Any descending chain of varieties*

$$V_1 \supset V_2 \supset V_3 \supset \cdots$$

*in  $k^n$  must stabilize. That is, there exists a positive integer  $N$  such that  $V_N = V_{N+1} = \cdots$ .*

**Proof.** Passing to the corresponding ideals gives an ascending chain of ideals

$$\mathbf{I}(V_1) \subset \mathbf{I}(V_2) \subset \mathbf{I}(V_3) \subset \cdots$$

By the ascending chain condition for ideals (see Theorem 7 of Chapter 2, §5), there exists  $N$  such that  $\mathbf{I}(V_N) = \mathbf{I}(V_{N+1}) = \cdots$ . Since  $\mathbf{V}(\mathbf{I}(V)) = V$  for any variety  $V$ , we have  $V_N = V_{N+1} = \cdots$ .  $\square$

We can use Proposition 1 to prove the following basic result about the structure of affine varieties.

**Theorem 2.** *Let  $V \subset k^n$  be an affine variety. Then  $V$  can be written as a finite union*

$$V = V_1 \cup \cdots \cup V_m,$$

*where each  $V_i$  is an irreducible variety.*

**Proof.** Assume that  $V$  is an affine variety which cannot be written as a finite union of irreducibles. Then  $V$  is not irreducible, so that  $V = V_1 \cup V'_1$ , where  $V \neq V_1$  and  $V \neq V'_1$ . Further, one of  $V_1$  and  $V'_1$  must not be a finite union of irreducibles, for otherwise  $V$  would be of the same form. Say  $V_1$  is not a finite union of irreducibles. Repeating the argument just given, we can write  $V_1 = V_2 \cup V'_2$ , where  $V_1 \neq V_2$ ,  $V_1 \neq V'_2$ , and  $V_2$  is not a finite union of irreducibles. Continuing in this way gives us an infinite sequence of affine varieties

$$V \supset V_1 \supset V_2 \supset \cdots$$

with

$$V \neq V_1 \neq V_2 \neq \cdots$$

This contradicts Proposition 1.  $\square$

As a simple example of Theorem 2, consider the variety  $\mathbf{V}(xz, yz)$  which is a union of a line (the  $z$ -axis) and a plane (the  $xy$ -plane), both of which are irreducible by

Exercise 6 of §5. For a more complicated example of the decomposition of a variety into irreducibles, consider the variety

$$V = \mathbf{V}(xz - y^2, x^3 - yz).$$

Here is a sketch of this variety.

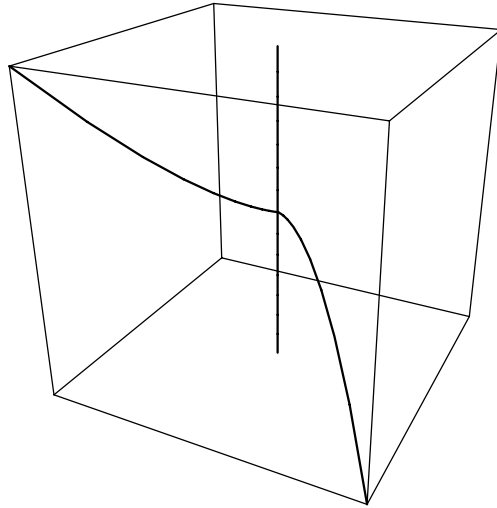

The picture suggests that this variety is not irreducible. It appears to be a union of two curves. Indeed, since both  $xz - y^2$  and  $x^3 - yz$  vanish on the  $z$ -axis, it is clear that the  $z$ -axis  $\mathbf{V}(x, y)$  is contained in  $V$ . What about the other curve  $V - \mathbf{V}(x, y)$ ?

By Theorem 7 of §4, this suggests looking at the ideal quotient

$$\langle xz - y^2, x^3 - yz \rangle : \langle x, y \rangle.$$

(At the end of the section we will see that  $\langle xz - y^2, x^3 - yz \rangle$  is a radical ideal.) We can compute this quotient using our algorithm for computing ideal quotients (make sure you review this algorithm). By equation (5) of §4, the above is equal to

$$(I : x) \cap (I : y),$$

where  $I = \langle xz - y^2, x^3 - yz \rangle$ . To compute  $I : x$ , we first compute  $I \cap \langle x \rangle$  using our algorithm for computing intersections of ideals. Using lex order with  $z > y > x$ , we obtain

$$I \cap \langle x \rangle = \langle x^2z - xy^2, x^4 - xyz, x^3y - xz^2, x^5 - xy^3 \rangle.$$

We can omit  $x^5 - xy^3$  since it is a combination of the first and second elements in the

basis. Hence

$$\begin{aligned}
 (1) \quad I : x &= \left\langle \frac{x^2z - xy^2}{x}, \frac{x^4 - xyz}{x}, \frac{x^3y - xz^2}{x} \right\rangle \\
 &= \langle xz - y^2, x^3 - yz, x^2y - z^2 \rangle \\
 &= I + \langle x^2y - z^2 \rangle.
 \end{aligned}$$

Similarly, to compute  $I : \langle y \rangle$ , we compute

$$I \cap \langle y \rangle = \langle xyz - y^3, x^3y - y^2z, x^2y^2 - yz^2 \rangle,$$

which gives

$$\begin{aligned}
 I : y &= \left\langle \frac{xyz - y^3}{y}, \frac{x^3y - y^2z}{y}, \frac{x^2y^2 - yz^2}{y} \right\rangle \\
 &= \langle xz - y^2, x^3 - yz, x^2y - z^2 \rangle \\
 &= I + \langle x^2y - z^2 \rangle \\
 &= I : x
 \end{aligned}$$

(Do the computations using a computer algebra system.) Since  $I : x = I : y$ , we have

$$I : \langle x, y \rangle = \langle xz - y^2, x^3 - yz, x^2y - z^2 \rangle.$$

The variety  $W = \mathbf{V}(xz - y^2, x^3 - yz, x^2y - z^2)$  turns out to be an irreducible curve. To see this, note that it can be parametrized as  $(t^3, t^4, t^5)$  [it is clear that  $(t^3, t^4, t^5) \in W$  for any  $t$ —we leave it as an exercise to show every point of  $W$  is of this form], so that  $W$  is irreducible by Proposition 5 of the last section. It then follows easily that

$$V = \mathbf{V}(x, y) \cup W$$

(see Theorem 7 of §4), which gives decomposition of  $V$  into irreducibles.

Both in the above example and the case of  $\mathbf{V}(xz, yz)$ , it appears that the decomposition of a variety is unique. It is natural to ask whether this is true in general. It is clear that, to avoid trivialities, we must rule out decompositions in which the same irreducible component appears more than once, or in which one irreducible component contains another. This is the aim of the following definition.

**Definition 3.** Let  $V \subset k^n$  be an affine variety. A decomposition

$$V = V_1 \cup \cdots \cup V_m,$$

where each  $V_i$  is an irreducible variety, is called a **minimal decomposition** (or, sometimes, an **irredundant union**) if  $V_i \not\subset V_j$  for  $i \neq j$ .

With this definition, we can now prove the following uniqueness result.

**Theorem 4.** Let  $V \subset k^n$  be an affine variety. Then  $V$  has a minimal decomposition

$$V = V_1 \cup \cdots \cup V_m$$

(so each  $V_i$  is an irreducible variety and  $V_i \not\subset V_j$  for  $i \neq j$ ). Furthermore, this minimal decomposition is unique up to the order in which  $V_1, \dots, V_m$  are written.

**Proof.** By Theorem 2,  $V$  can be written in the form  $V = V_1 \cup \dots \cup V_m$ , where each  $V_i$  is irreducible. Further, if a  $V_i$  lies in some  $V_j$  for  $i \neq j$ , we can drop  $V_i$ , and  $V$  will be the union of the remaining  $V_j$ 's for  $j \neq i$ . Repeating this process leads to a minimal decomposition of  $V$ .

To show uniqueness, suppose that  $V = V'_1 \cup \dots \cup V'_l$  is another minimal decomposition of  $V$ . Then, for each  $V_i$  in the first decomposition, we have

$$V_i = V_i \cap V = V_i \cap (V'_1 \cup \dots \cup V'_l) = (V_i \cap V'_1) \cup \dots \cup (V_i \cap V'_l).$$

Since  $V_i$  is irreducible, it follows that  $V_i = V_i \cap V'_j$  for some  $j$ , i.e.,  $V_i \subset V'_j$ . Applying the same argument to  $V'_j$  (using the  $V_i$ 's to decompose  $V$ ) shows that  $V'_j \subset V_k$  for some  $k$ , and, thus,

$$V_i \subset V'_j \subset V_k.$$

By minimality,  $i = k$ , and it follows that  $V_i = V'_j$ . Hence, every  $V_i$  appears in  $V = V'_1 \cup \dots \cup V'_l$ , which implies  $m \leq l$ . A similar argument proves  $l \leq m$ , and  $m = l$  follows. Thus, the  $V'_i$ 's are just a permutation of the  $V_i$ 's, and uniqueness is proved.  $\square$

We remark that the uniqueness part of Theorem 4 is false if one does not insist that the union be finite. (A plane  $P$  is the union of all the points on it. It is also the union of some line in  $P$  and all the points not on the line—there are infinitely many lines in  $P$  with which one could start.) This should alert the reader to the fact that although the proof of Theorem 4 is easy, it is far from vacuous: one makes subtle use of finiteness (which follows, in turn, from the Hilbert Basis Theorem).

Theorems 2 and 4 can also be expressed purely algebraically using the one-to-one correspondence between radical ideals and varieties.

**Theorem 5.** *If  $k$  is algebraically closed, then every radical ideal in  $k[x_1, \dots, x_n]$  can be written uniquely as a finite intersection of prime ideals,  $I = P_1 \cap \dots \cap P_r$ , where  $P_i \not\subset P_j$  for  $i \neq j$ . (As in the case of varieties, we often call such a presentation of a radical ideal a **minimal decomposition** or an **irredundant intersection**).*

**Proof.** Theorem 5 follows immediately from Theorems 2 and 4 and the ideal–variety correspondence.  $\square$

We can also use ideal quotients from §4 to describe the prime ideals that appear in the minimal representation of a radical ideal.

**Theorem 6.** *If  $k$  is algebraically closed and  $I$  is a proper radical ideal such that*

$$I = \bigcap_{i=1}^r P_i$$



is its minimal decomposition as an intersection of prime ideals, then the  $P_i$ 's are precisely the proper prime ideals that occur in the set  $\{I : f : f \in k[x_1, \dots, x_n]\}$ .

**Proof.** First, note that since  $I$  is proper, each  $P_i$  is also a proper ideal (this follows from minimality).

For any  $f \in k[x_1, \dots, x_n]$ , we have

$$I : f = \left( \bigcap_{i=1}^r P_i \right) : f = \bigcap_{i=1}^r (P_i : f)$$

by equation (2) of §4. Note also that for any prime ideal  $P$ , either  $f \in P$ , in which case  $P : f = \langle 1 \rangle$ , or  $f \notin P$ , in which case  $P : f = P$  (see Exercise 3).

Now suppose that  $I : f$  is a proper prime ideal. By Exercise 4 of §5, the above formula for  $I : f$  implies that  $I : f = P_i : f$  for some  $i$ . Since  $P_i : f = P_i$  or  $\langle 1 \rangle$  by the above observation, it follows that  $I : f = P_i$ .

To see that every  $P_i$  can arise in this way, fix  $i$  and pick  $f \in \left( \bigcap_{j \neq i} P_j \right) - P_i$ ; such an  $f$  exists because  $\bigcap_{i=1}^r P_i$  is minimal. Then  $P_i : f = P_i$  and  $P_j : f = \langle 1 \rangle$  for  $j \neq i$ . If we combine this with the above formula for  $I : f$ , then it follows easily that  $I : f = P_i$ . □

We should mention that Theorems 5 and 6 hold for any field  $k$ , although the proofs in the general case are different (see Corollary 10 of §7).

For an example of what these theorems say, consider the ideal  $I = \langle xz - y^2, x^3 - yz \rangle$ . Recall that the variety  $V = \mathbf{V}(I)$  was discussed earlier in this section. For the time being, let us assume that  $I$  is radical (eventually we will see that this is true). Can we write  $I$  as an intersection of prime ideals?

We start with the geometric decomposition

$$V = \mathbf{V}(x, y) \cup W$$

proved earlier, where  $W = \mathbf{V}(xz - y^2, x^3 - yz, x^2y - z^2)$ . This suggests that

$$I = \langle x, y \rangle \cap \langle xz - y^2, x^3 - yz, x^2y - z^2 \rangle,$$

which is straightforward to prove by the techniques we have learned so far (see Exercise 4). Also, from equation (1), we know that  $I : x = \langle xz - y^2, x^3 - yz, x^2y - z^2 \rangle$ . Thus,

$$I = \langle x, y \rangle \cap (I : x).$$

To represent  $\langle x, y \rangle$  as an ideal quotient of  $I$ , let us think geometrically. The idea is to remove  $W$  from  $V$ . Of the three equations defining  $W$ , the first two give  $V$ . So it makes sense to use the third one,  $x^2y - z^2$ , and one can check that  $I : (x^2y - z^2) = \langle x, y \rangle$  (see Exercise 4). Thus,

$$(2) \quad I = (I : (x^2y - z^2)) \cap (I : x).$$

It remains to show that  $I : (x^2y - z^2)$  and  $I : x$  are prime ideals. The first is easy since  $I : (x^2y - z^2) = \langle x, y \rangle$  is obviously prime. As for the second, we have already seen that  $W = \mathbf{V}(xz - y^2, x^3 - yz, x^2y - z^2)$  is irreducible and, in the exercises, you will

show that  $\mathbf{I}(W) = \langle xz - y^2, x^3 - yz, x^2y - z^2 \rangle = I : x$ . It follows from Proposition 3 of §5 that  $I : x$  is a prime ideal. This completes the proof that (2) is the minimal representation of  $I$  as an intersection of prime ideals. Finally, since  $I$  is an intersection of prime ideals, we see that  $I$  is a radical ideal (see Exercise 1).

The arguments used in this example are special to the case  $I = \langle xz - y^2, x^3 - yz \rangle$ . It would be nice to have more general methods that could be applied to any ideal. Theorems 2, 4, 5, and 6 tell us that certain decompositions exist, but the proofs give no indication of how to find them. The problem is that the proofs rely on the Hilbert Basis Theorem, which is intrinsically nonconstructive. Based on what we have seen in §§5 and 6, the following questions arise naturally:

- (Primality) Is there an algorithm for deciding if a given ideal is prime?
- (Irreducibility) Is there an algorithm for deciding if a given affine variety is irreducible?
- (Decomposition) Is there an algorithm for finding the minimal decomposition of a given variety or radical ideal?

The answer to all three questions is *yes*, and descriptions of the algorithms can be found in the works of HERMANN (1926), MINES, RICHMAN, and RUITENBERG (1988), and SEIDENBERG (1974, 1984). As in §2, the algorithms in these articles are not very practical. However, the work of GIANNI, TRAGER, and ZACHARIAS (1988) has led to algorithms implemented in AXIOM and REDUCE that answer the above questions. See also Chapter 8 of BECKER and WEISPFENNING (1993) and, for the primality algorithm, §4.4 of ADAMS and LOUSTAUNAU (1994). A different algorithm for studying these questions, based on ideas of EISENBUD, HUNEKE and VASCONCELOS (1992), has been implemented in Macaulay 2.

**EXERCISES FOR §6**

1. Show that the intersection of any collection of prime ideals is radical.
2. Show that an irredundant intersection of at least two prime ideals is never prime.
3. If  $P \subset k[x_1, \dots, x_n]$  is a prime ideal, then prove that  $P : f = P$  if  $f \notin P$  and  $P : f = \langle 1 \rangle$  if  $f \in P$ .
4. Let  $I = \langle xz - y^2, x^3 - yz \rangle$ .
  - a. Show that  $I : (x^2y - z^2) = \langle x, y \rangle$ .
  - b. Show that  $I : (x^2y - z^2)$  is prime.
  - c. Show that  $I = \langle x, y \rangle \cap \langle xz - y^2, x^3 - yz, z^2 - x^2y \rangle$ .
5. Let  $J = \langle xz - y^2, x^3 - yz, z^2 - x^2y \rangle \subset k[x, y, z]$ , where  $k$  is infinite.
  - a. Show that every point of  $W = \mathbf{V}(J)$  is of the form  $(t^3, t^4, t^5)$  for some  $t \in k$ .
  - b. Show that  $J = \mathbf{I}(W)$ . Hint: Compute a Groebner basis for  $J$  using lex order with  $z > y > x$  and show that every  $f \in k[x, y, z]$  can be written in the form

$$f = g + a + bz + xA(x) + yB(x) + y^2C(x),$$

where  $g \in J, a, b \in k$  and  $A, B, C \in k[x]$ .

6. Translate Theorem 6 and its proof into geometry.
7. Let  $I = \langle xz - y^2, z^3 - x^5 \rangle \subset \mathbb{Q}[x, y, z]$ .
  - a. Express  $\mathbf{V}(I)$  as a finite union of irreducible varieties. Hint: You will use the parametrizations  $(t^3, t^4, t^5)$  and  $(t^3, -t^4, t^5)$ .

- b. Express  $I$  as an intersection of prime ideals which are ideal quotients of  $I$  and conclude that  $I$  is radical.
- 8. Let  $V, W$  be varieties in  $k^n$  with  $V \subset W$ . Show that each irreducible component of  $V$  is contained in some irreducible component of  $W$ .
- 9. Let  $f \in \mathbb{C}[x_1, \dots, x_n]$  and let  $f = f_1^{a_1} f_2^{a_2} \dots f_r^{a_r}$  be the decomposition of  $f$  into irreducible factors. Show that  $\mathbf{V}(f) = \mathbf{V}(f_1) \cup \dots \cup \mathbf{V}(f_r)$  is the decomposition of  $\mathbf{V}(f)$  into irreducible components and  $\mathbf{I}(\mathbf{V}(f)) = \langle f_1 f_2 \dots f_r \rangle$ . Hint: See Exercise 11 of §5.

## §7 (Optional) Primary Decomposition of Ideals

In view of the decomposition theorem proved in §6 for radical ideals, it is natural to ask whether an arbitrary ideal  $I$  (not necessarily radical) can be represented as an intersection of simpler ideals. In this section, we will prove the Lasker–Noether decomposition theorem, which describes the structure of  $I$  in detail.

There is no hope of writing an arbitrary ideal  $I$  as an intersection of prime ideals (since an intersection of prime ideals is always radical). The next thing that suggests itself is to write  $I$  as an intersection of powers of prime ideals. This does not quite work either: consider the ideal  $I = \langle x, y^2 \rangle$  in  $\mathbb{C}[x, y]$ . Any prime ideal containing  $I$  must contain  $x$  and  $y$  and, hence, must equal  $\langle x, y \rangle$  (since  $\langle x, y \rangle$  is maximal). Thus, if  $I$  were to be an intersection of powers of prime ideals, it would have to be a power of  $\langle x, y \rangle$  (see Exercise 1 for the details).

The concept we need is a bit more subtle.

**Definition 1.** An ideal  $I$  in  $k[x_1, \dots, x_n]$  is **primary** if  $fg \in I$  implies either  $f \in I$  or some power  $g^m \in I$  (for some  $m > 0$ ).

It is easy to see that prime ideals are primary. Also, you can check that the ideal  $I = \langle x, y^2 \rangle$  discussed above is primary (see Exercise 1).

**Lemma 2.** If  $I$  is a primary ideal, then  $\sqrt{I}$  is prime and is the smallest prime ideal containing  $I$ .

**Proof.** See Exercise 2. □

In view of this lemma, we make the following definition.

**Definition 3.** If  $I$  is primary and  $\sqrt{I} = P$ , then we say that  $I$  is  **$P$ -primary**.

We can now prove that every ideal is an intersection of primary ideals.

**Theorem 4.** Every ideal  $I \subset k[x_1, \dots, x_n]$  can be written as a finite intersection of primary ideals.

**Proof.** We first define an ideal  $I$  to be *irreducible* if  $I = I_1 \cap I_2$  implies that  $I = I_1$  or  $I = I_2$ . We claim that every ideal is an intersection of finitely many irreducible ideals.

The argument is an “ideal” version of the proof of Theorem 2 from §6. One uses the ACC rather than the DCC—we leave the details as an exercise.

Next we claim that an irreducible ideal is primary. Note that this will prove the theorem. To see why the claim is true, suppose that  $I$  is irreducible and that  $fg \in I$  with  $f \notin I$ . We need to prove that some power of  $g$  lies in  $I$ . Consider the ideals  $I : g^n$  for  $n \geq 1$ . In the exercises, you will show that  $I : g^n \subset I : g^{n+1}$  for all  $n$ . Thus, we get the ascending chain of ideals

$$I : g \subset I : g^2 \subset \cdots .$$

By the ascending chain condition, there exists an integer  $N \geq 1$  such that  $I : g^N = I : g^{N+1}$ . We will leave it as an exercise to show that  $(I + \langle g^N \rangle) \cap (I + \langle f \rangle) = I$ . Since  $I$  is irreducible, it follows that  $I = I + \langle g^N \rangle$  or  $I = I + \langle f \rangle$ . The latter cannot occur since  $f \notin I$ , so that  $I = I + \langle g^N \rangle$ . This proves that  $g^N \in I$ .  $\square$

As in the case of varieties, we can define what it means for a decomposition to be minimal.

**Definition 5.** A primary decomposition of an ideal  $I$  is an expression of  $I$  as an intersection of primary ideals:  $I = \bigcap_{i=1}^r Q_i$ . It is called **minimal** or **irredundant** if the  $\sqrt{Q_i}$  are all distinct and  $Q_i \not\supset \bigcap_{j \neq i} Q_j$ .

To prove the existence of a minimal decomposition, we will need the following lemma, the proof of which we leave as an exercise.

**Lemma 6.** If  $I, J$  are primary and  $\sqrt{I} = \sqrt{J}$ , then  $I \cap J$  is primary.

We can now prove the first part of the Lasker–Noether decomposition theorem.

**Theorem 7 (Lasker–Noether).** Every ideal  $I \subset k[x_1, \dots, x_n]$  has a minimal primary decomposition.

**Proof.** By Theorem 4, we know that there is a primary decomposition  $I = \bigcap_{i=1}^r Q_i$ . Suppose that  $Q_i$  and  $Q_j$  have the same radical for some  $i \neq j$ . Then, by Lemma 6,  $Q = Q_i \cap Q_j$  is primary, so that in the decomposition of  $I$ , we can replace  $Q_i$  and  $Q_j$  by the single ideal  $Q$ . Continuing in this way, eventually all of the  $Q_i$ ’s will have distinct radicals.

Next, suppose that some  $Q_i$  contains  $\bigcap_{j \neq i} Q_j$ . Then we can omit  $Q_i$ , and  $I$  will be the intersection of the remaining  $Q_j$ ’s for  $j \neq i$ . Continuing in this way, we can reduce to the case where  $Q_i \not\supset \bigcap_{j \neq i} Q_j$  for all  $i$ .  $\square$

Unlike the case of varieties (or radical ideals), a minimal primary decomposition need not be unique. In the exercises, you will verify that the ideal  $\langle x^2, xy \rangle \subset k[x, y]$  has the two distinct minimal decompositions

$$\langle x^2, xy \rangle = \langle x \rangle \cap \langle x^2, xy, y^2 \rangle = \langle x \rangle \cap \langle x^2, y \rangle.$$

Although  $\langle x^2, xy, y^2 \rangle$  and  $\langle x^2, y \rangle$  are distinct, note that they have the same radical. To prove that this happens in general, we will use ideal quotients from §4. We start by computing some ideal quotients of a primary ideal.

**Lemma 8.** *If  $I$  is primary and  $\sqrt{I} = P$  and if  $f \in k[x_1, \dots, x_n]$ , then:*

$$\begin{aligned} \text{if } f \in I, & \quad \text{then } I : f = \langle 1 \rangle, \\ \text{if } f \notin I, & \quad \text{then } I : f \text{ is } P\text{-primary}, \\ \text{if } f \notin P, & \quad \text{then } I : f = I. \end{aligned}$$

**Proof.** See Exercise 7. □

The second part of the Lasker–Noether theorem tells us that the *radicals* of the ideals in a minimal decomposition are uniquely determined.

**Theorem 9 (Lasker–Noether).** *Let  $I = \bigcap_{i=1}^r Q_i$  be a minimal primary decomposition of a proper ideal  $I \subset k[x_1, \dots, x_n]$  and let  $P_i = \sqrt{Q_i}$ . Then the  $P_i$  are precisely the proper prime ideals occurring in the set  $\{\sqrt{I : f} : f \in k[x_1, \dots, x_n]\}$ .*

**Remark.** In particular, the  $P_i$  are independent of the primary decomposition of  $I$ . We say the  $P_i$  belong to  $I$ .

**Proof.** The proof is very similar to the proof of Theorem 6 from §6. The details are covered in Exercises 8–10. □

In §6, we proved a decomposition theorem for radical ideals over an algebraically closed field. Using Lasker–Noether theorems, we can now show that these results hold over an arbitrary field  $k$ .

**Corollary 10.** *Let  $I = \bigcap_{i=1}^r Q_i$  be a minimal primary decomposition of a proper radical ideal  $I \subset k[x_1, \dots, x_n]$ . Then the  $Q_i$  are prime and are precisely the proper prime ideals occurring in the set  $\{I : f : f \in k[x_1, \dots, x_n]\}$ .*

**Proof.** See Exercise 12. □

The two Lasker–Noether theorems do not tell the full story of a minimal primary decomposition  $I = \bigcap_{i=1}^r Q_i$ . For example, if  $P_i$  is minimal in the sense that no  $P_j$  is strictly contained in  $P_i$ , then one can show that  $Q_i$  is uniquely determined. Thus there is a uniqueness theorem for *some* of the  $Q_i$ 's [see Chapter 4 of ATIYAH and MACDONALD (1969) for the details]. We should also mention that the conclusion of Theorem 9 can be strengthened: one can show that the  $P_i$ 's are precisely the proper prime ideals in the set  $\{I : f : f \in k[x_1, \dots, x_n]\}$  [see Chapter 7 of ATIYAH and MACDONALD (1969)].

Finally, it is natural to ask if a primary decomposition can be done constructively. More precisely, given  $I = \langle f_1, \dots, f_s \rangle$ , we can ask the following:

- (Primary Decomposition) Is there an algorithm for finding bases for the primary ideals  $Q_i$  in a minimal primary decomposition of  $I$ ?
- (Associated Primes) Can we find bases for the associated primes  $P_i = \sqrt{Q_i}$ ?

If you look in the references given at the end of §6, you will see that the answer to these questions is *yes*. Primary decomposition has been implemented in AXIOM, REDUCE, and MACAULAY 2.

### EXERCISES FOR §7

- Consider the ideal  $I = \langle x, y^2 \rangle \subset \mathbb{C}[x, y]$ .
  - Prove that  $\langle x, y \rangle^2 \subsetneq I \subsetneq \langle x, y \rangle$ , and conclude that  $I$  is not a prime power.
  - Prove that  $I$  is primary.
- Prove Lemma 2.
- This exercise is concerned with the proof of Theorem 4. Let  $I \subset k[x_1, \dots, x_n]$  be an ideal.
  - Using the hints given in the text, prove that  $I$  is a finite intersection of irreducible ideals.
  - If  $g \in k[x_1, \dots, x_n]$ , then prove that  $I : g^m \subset I : g^{m+1}$  for all  $m \geq 1$ .
  - Suppose that  $fg \in I$ . If, in addition,  $I : g^N = I : g^{N+1}$ , then prove that  $(I + \langle g^N \rangle) \cap (I + \langle f \rangle) = I$ . Hint: Elements of  $(I + \langle g^N \rangle) \cap (I + \langle f \rangle)$  can be written as  $a + bg^N = c + df$ , where  $a, c \in I$  and  $b, d \in k[x_1, \dots, x_n]$ . Now multiply through by  $g$ .
- In the proof of Theorem 4, we showed that every irreducible ideal is primary. Surprisingly, the converse is false. Let  $I$  be the ideal  $\langle x^2, xy, y^2 \rangle \subset k[x, y]$ .
  - Show that  $I$  is primary.
  - Show that  $I = \langle x^2, y \rangle \cap \langle x, y^2 \rangle$  and conclude that  $I$  is not irreducible.
- Prove Lemma 6. Hint: Proposition 16 from §3 will be useful.
- Let  $I$  be the ideal  $\langle x^2, xy \rangle \subset \mathbb{Q}[x, y]$ .
  - Prove that

$$I = \langle x \rangle \cap \langle x^2, xy, y^2 \rangle = \langle x \rangle \cap \langle x^2, y \rangle$$

are two distinct minimal primary decompositions of  $I$ .

- Prove that for any  $a \in \mathbb{Q}$ ,

$$I = \langle x \rangle \cap \langle x^2, y - ax \rangle$$

is a minimal primary decomposition of  $I$ . Thus  $I$  has infinitely many distinct minimal primary decompositions.

- Prove Lemma 8.
- Prove that an ideal is proper if and only if its radical is.
- Let  $I$  be a proper ideal. Prove that the primes belonging to  $I$  are also proper ideals. Hint: Use Exercise 8.
- Prove Theorem 9. Hint: Adapt the proof of Theorem 6 from §6. The extra ingredient is that you will need to take radicals. Proposition 16 from §3 will be useful. You will also need to use Exercise 9 and Lemma 8.
- Let  $P_1, \dots, P_r$  be the prime ideals belonging to  $I$ .
  - Prove that  $\sqrt{I} = \bigcap_{i=1}^r P_i$ . Hint: Use Proposition 16 from §3.
  - Use the ideal of Exercise 4 to show that  $\sqrt{I} = \bigcap_{i=1}^r P_i$  need not be a minimal decomposition of  $\sqrt{I}$ .
- Prove Corollary 10. Hint: Show that  $I : f$  is radical whenever  $I$  is.

## §8 Summary

The following table summarizes the results of this chapter. In the table, it is supposed that all ideals are radical and that the field is algebraically closed.

<b>ALGEBRA</b>		<b>GEOMETRY</b>
radical ideals		varieties
$I$	$\longrightarrow$	$\mathbf{V}(I)$
$\mathbf{I}(V)$	$\longleftarrow$	$V$
addition of ideals		intersection of varieties
$I + J$	$\longrightarrow$	$\mathbf{V}(I) \cap \mathbf{V}(J)$
$\sqrt{\mathbf{I}(V) + \mathbf{I}(W)}$	$\longleftarrow$	$V \cap W$
product of ideals		union of varieties
$IJ$	$\longrightarrow$	$\mathbf{V}(I) \cup \mathbf{V}(J)$
$\sqrt{\mathbf{I}(V)\mathbf{I}(W)}$	$\longleftarrow$	$V \cup W$
intersection of ideals		union of varieties
$I \cap J$	$\longrightarrow$	$\mathbf{V}(I) \cup \mathbf{V}(J)$
$\mathbf{I}(V) \cap \mathbf{I}(W)$	$\longleftarrow$	$V \cup W$
quotient of ideals		difference of varieties
$I : J$	$\longrightarrow$	$\overline{\mathbf{V}(I) - \mathbf{V}(J)}$
$\mathbf{I}(V) : \mathbf{I}(W)$	$\longleftarrow$	$\overline{V - W}$
elimination of variables		projection of varieties
$\sqrt{I \cap k[x_{l+1}, \dots, x_n]}$	$\longleftrightarrow$	$\pi_l(\mathbf{V}(I))$
prime ideal		irreducible variety
maximal ideal		point of affine space
ascending chain condition		descending chain condition

# 5

## Polynomial and Rational Functions on a Variety

One of the unifying themes of modern mathematics is that in order to understand any class of mathematical objects, one should also study *mappings* between those objects, and especially the mappings which preserve some property of interest. For instance, in linear algebra after studying vector spaces, you also studied the properties of *linear mappings* between vector spaces (mappings that preserve the vector space operations of sum and scalar product).

In this chapter, we will consider mappings between varieties, and the results of our investigation will form another chapter of the “algebra–geometry dictionary” that we started in Chapter 4. The algebraic properties of polynomial and rational functions on a variety yield many insights into the geometric properties of the variety itself. This chapter will also serve as an introduction to (and motivation for) the idea of a quotient ring.

### §1 Polynomial Mappings

We will begin our study of functions between varieties by reconsidering two examples that we have encountered previously. First, recall the tangent surface of the twisted cubic curve in  $\mathbb{R}^3$ . As in equation (1) of Chapter 3, §3 we describe this surface parametrically:

$$(1) \quad \begin{aligned} x &= t + u, \\ y &= t^2 + 2tu, \\ z &= t^3 + 3t^2u. \end{aligned}$$

In functional language, giving the parametric representation (1) is equivalent to defining a mapping

$$\phi : \mathbb{R}^2 \longrightarrow \mathbb{R}^3$$

by

$$(2) \quad \phi(t, u) = (t + u, t^2 + 2tu, t^3 + 3t^2u).$$

The domain of  $\phi$  is an affine variety  $V = \mathbb{R}^2$  and the image of  $\phi$  is the tangent surface  $S$ .



We saw in §3 of Chapter 3 that  $S$  is the same as the affine variety

$$W = \mathbf{V}(x^3z - (3/4)x^2y^2 - (3/2)xyz + y^3 + (1/4)z^2).$$

Hence, our parametrization gives what we might call a *polynomial mapping* between  $V$  and  $W$ . (The adjective “polynomial” refers to the fact that the component functions of  $\phi$  are polynomials in  $t$  and  $u$ .)

Second, in the discussion of the geometry of elimination of variables from systems of equations in §2 of Chapter 3, we considered the projection mappings

$$\pi_k : \mathbb{C}^n \longrightarrow \mathbb{C}^{n-k}$$

defined by

$$\pi_k(a_1, \dots, a_n) = (a_{k+1}, \dots, a_n).$$

If we have a variety  $V = \mathbf{V}(I) \subset \mathbb{C}^n$ , then we can also restrict  $\pi_k$  to  $V$  and, as we know,  $\pi_k(V)$  will be contained in the affine variety  $W = \mathbf{V}(I_k)$ , where  $I_k = I \cap \mathbb{C}[x_{k+1}, \dots, x_n]$ , the  $k$ th elimination ideal of  $I$ . Hence, we can consider  $\pi_k : V \rightarrow W$  as a mapping of varieties. Here too, by the definition of  $\pi_k$  we see that the component functions of  $\pi_k$  are polynomials in the coordinates in the domain.

**Definition 1.** Let  $V \subset k^m$ ,  $W \subset k^n$  be varieties. A function  $\phi : V \rightarrow W$  is said to be a **polynomial mapping** (or **regular mapping**) if there exist polynomials  $f_1, \dots, f_n \in k[x_1, \dots, x_m]$  such that

$$\phi(a_1, \dots, a_m) = (f_1(a_1, \dots, a_m), \dots, f_n(a_1, \dots, a_m))$$

for all  $(a_1, \dots, a_m) \in V$ . We say that the  $n$ -tuple of polynomials

$$(f_1, \dots, f_n) \in (k[x_1, \dots, x_m])^n$$

represents  $\phi$ .

To say that  $\phi$  is a polynomial mapping from  $V \subset k^m$  to  $W \subset k^n$  represented by  $(f_1, \dots, f_n)$  means that  $(f_1(a_1, \dots, a_m), \dots, f_n(a_1, \dots, a_m))$  must satisfy the defining equations of  $W$  for all  $(a_1, \dots, a_m) \in V$ . For example, consider  $V = \mathbf{V}(y - x^2, z - x^3) \subset k^3$  (the twisted cubic) and  $W = \mathbf{V}(y^3 - z^2) \subset k^2$ . Then the projection  $\pi_1 : k^3 \rightarrow k^2$  represented by  $(y, z)$  gives a polynomial mapping  $\pi_1 : V \rightarrow W$ . This is true because every point in  $\pi_1(V) = \{(x^2, x^3) : x \in k\}$  satisfies the defining equation of  $W$ .

Of particular interest is the case  $W = k$ , where  $\phi$  simply becomes a scalar polynomial function defined on the variety  $V$ . One reason to consider polynomial functions from  $V$  to  $k$  is that a general polynomial mapping  $\phi : V \rightarrow k^n$  is constructed by using any  $n$  polynomial functions  $\phi : V \rightarrow k$  as the components. Hence, if we understand functions  $\phi : V \rightarrow k$ , we understand how to construct all mappings  $\phi : V \rightarrow k^n$  as well.

To begin our study of polynomial functions, note that, for  $V \subset k^m$ , Definition 1 says that a mapping  $\phi : V \rightarrow k$  is a polynomial function if *there exists* a polynomial  $f \in k[x_1, \dots, x_m]$  representing  $\phi$ . In fact, we usually specify a polynomial function by giving an explicit polynomial representative. Thus, finding a representative is not actually the key issue. What we will see next, however, is that the cases where a representative is uniquely determined are very rare. For example, consider the variety

$V = \mathbf{V}(y - x^2) \subset \mathbb{R}^2$ . The polynomial  $f = x^3 + y^3$  represents a polynomial function from  $V$  to  $\mathbb{R}$ . However,  $g = x^3 + y^3 + (y - x^2)$ ,  $h = x^3 + y^3 + (x^4y - x^6)$ , and  $F = x^3 + y^3 + A(x, y)(y - x^2)$  for any  $A(x, y)$  define *the same polynomial function* on  $V$ . Indeed, since  $\mathbf{I}(V)$  is the set of polynomials which are zero at every point of  $V$ , adding any element of  $\mathbf{I}(V)$  to  $f$  does not change the values of the polynomial at the points of  $V$ . The general pattern is the same.

**Proposition 2.** *Let  $V \subset k^m$  be an affine variety. Then*

- (i)  *$f$  and  $g \in k[x_1, \dots, x_m]$  represent the same polynomial function on  $V$  if and only if  $f - g \in \mathbf{I}(V)$ .*
- (ii)  *$(f_1, \dots, f_n)$  and  $(g_1, \dots, g_n)$  represent the same polynomial mapping from  $V$  to  $k^n$  if and only if  $f_i - g_i \in \mathbf{I}(V)$  for each  $i$ ,  $1 \leq i \leq n$ .*

**Proof.** (i) If  $f - g = h \in \mathbf{I}(V)$ , then for any  $p = (a_1, \dots, a_m) \in V$ ,  $f(p) - g(p) = h(p) = 0$ . Hence,  $f$  and  $g$  represent the same function on  $V$ . Conversely, if  $f$  and  $g$  represent the same function, then, at every  $p \in V$ ,  $f(p) - g(p) = 0$ . Thus,  $f - g \in \mathbf{I}(V)$  by definition. Part (ii) follows directly from (i).  $\square$

Thus, the correspondence between polynomials in  $k[x_1, \dots, x_m]$  and polynomial functions is one-to-one only in the case where  $\mathbf{I}(V) = \{0\}$ . In Exercise 7, you will show that  $\mathbf{I}(V) = \{0\}$  if and only if  $k$  is infinite and  $V = k^m$ .

There are two ways of dealing with this potential ambiguity in describing polynomial functions on a variety:

- In rough terms, we can “lump together” *all* the polynomials  $f \in k[x_1, \dots, x_m]$  that represent the same function on  $V$  and think of that collection as a “new object” in its own right. We can then take the collection of polynomials as our description of the function on  $V$ .
- Alternatively, we can systematically look for the simplest possible individual polynomial that represents each function on  $V$  and work with those “standard representative” polynomials exclusively.

Each of these approaches has its own advantages, and we will consider both of them in detail in later sections of this chapter. We will conclude this section by looking at two further examples to show the kinds of properties of varieties that can be revealed by considering polynomial functions.

**Definition 3.** *We denote by  $k[V]$  the collection of polynomial functions  $\phi : V \rightarrow k$ .*

Since  $k$  is a field, we can define a sum and a product function for any pair of functions  $\phi, \psi : V \rightarrow k$  by adding and multiplying images. For each  $p \in V$ ,

$$\begin{aligned}(\phi + \psi)(p) &= \phi(p) + \psi(p), \\(\phi \cdot \psi)(p) &= \phi(p) \cdot \psi(p).\end{aligned}$$

Furthermore, if we pick specific representatives  $f, g \in k[x_1, \dots, x_m]$  for  $\phi, \psi$ , respectively, then by definition, the polynomial sum  $f + g$  represents  $\phi + \psi$  and the

polynomial product  $f \cdot g$  represents  $\phi \cdot \psi$ . It follows that  $\phi + \psi$  and  $\phi \cdot \psi$  are polynomial functions on  $V$ .

Thus, we see that  $k[V]$  has sum and product operations constructed using the sum and product operations in  $k[x_1, \dots, x_m]$ . All of the usual properties of sums and products of polynomials also hold for functions in  $k[V]$ . Thus,  $k[V]$  is another example of a *commutative ring*. (See Appendix A for the precise definition.) We will also return to this point in §2.

Now we are ready to start exploring what  $k[V]$  can tell us about the geometric properties of a variety  $V$ . First, recall from §5 of Chapter 4 that a variety  $V \subset k^m$  is said to be *reducible* if it can be written as the union of two nonempty proper subvarieties:  $V = V_1 \cup V_2$ , where  $V_1 \neq V$  and  $V_2 \neq V$ . For example, the variety  $V = \mathbf{V}(x^3 + xy^2 - xz, yx^2 + y^3 - yz)$  in  $k^3$  is reducible since, from the factorizations of the defining equations, we can decompose  $V$  as  $V = \mathbf{V}(x^2 + y^2 - z) \cup \mathbf{V}(x, y)$ . We would like to demonstrate that geometric properties such as reducibility can be “read off” from a sufficiently good algebraic description of  $k[V]$ . To see this, let

$$(3) \quad f = x^2 + y^2 - z, \quad g = 2x^2 - 3y^4z \in k[x, y, z]$$

and let  $\phi, \psi$  be the corresponding elements of  $k[V]$ .

Note that neither  $\phi$  nor  $\psi$  is identically zero on  $V$ . For example, at  $(0, 0, 5) \in V$ ,  $\phi(0, 0, 5) = f(0, 0, 5) = -5 \neq 0$ . Similarly, at  $(1, 1, 2) \in V$ ,  $\psi(1, 1, 2) = g(1, 1, 2) = -4 \neq 0$ . However, the product function  $\phi \cdot \psi$  is zero at every point of  $V$ . The reason is that

$$\begin{aligned} f \cdot g &= (x^2 + y^2 - z)(2x^2 - 3y^4z) \\ &= 2x(x^3 + xy^2 - xz) - 3y^3z(x^2y + y^3 - yz) \\ &\in \langle x^3 + xy^2 - xz, x^2y + y^3 - yz \rangle. \end{aligned}$$

Hence  $f \cdot g \in \mathbf{I}(V)$ , so the corresponding polynomial function  $\phi \cdot \psi$  on  $V$  is identically zero.

The product of two nonzero elements of a field or of two nonzero polynomials in  $k[x_1, \dots, x_n]$  is never zero. In general, a commutative ring  $R$  is said to be an *integral domain* if whenever  $a \cdot b = 0$  in  $R$ , either  $a = 0$  or  $b = 0$ . Hence, for the variety  $V$  in the above example, we see that  $k[V]$  is not an integral domain. Furthermore, the existence of  $\phi \neq 0$  and  $\psi \neq 0$  in  $k[V]$  such that  $\phi \cdot \psi = 0$  is a direct consequence of the reducibility of  $V$ :  $f$  in (3) is zero on  $V_1 = \mathbf{V}(x^2 + y^2 - z)$ , but not on  $V_2 = \mathbf{V}(x, y)$ , and similarly  $g$  is zero on  $V_2$ , but not on  $V_1$ . This is why  $f \cdot g = 0$  at every point of  $V = V_1 \cup V_2$ . Hence, we see a relation between the geometric properties of  $V$  and the algebraic properties of  $k[V]$ .

The general case of this relation can be stated as follows.

**Proposition 4.** *Let  $V \subset k^n$  be an affine variety. The following statements are equivalent:*

- (i)  $V$  is irreducible.
- (ii)  $\mathbf{I}(V)$  is a prime ideal.
- (iii)  $k[V]$  is an integral domain.

**Proof.** (i)  $\Leftrightarrow$  (ii) is Proposition 3 of Chapter 4, §5.

To show (iii)  $\Rightarrow$  (i), suppose that  $k[V]$  is an integral domain but that  $V$  is reducible. By Definition 1 of Chapter 4, §5, this means that we can write  $V = V_1 \cup V_2$ , where  $V_1$  and  $V_2$  are proper, nonempty subvarieties of  $V$ . Let  $f_1 \in k[x_1, \dots, x_n]$  be a polynomial that vanishes on  $V_1$  but not identically on  $V_2$  and, similarly, let  $f_2$  be identically zero on  $V_2$ , but not on  $V_1$ . (Such polynomials must exist since  $V_1$  and  $V_2$  are varieties and neither is contained in the other.) Hence, neither  $f_1$  nor  $f_2$  represents the zero function in  $k[V]$ . However, the product  $f_1 \cdot f_2$  vanishes at all points of  $V_1 \cup V_2 = V$ . Hence, the product function is zero in  $k[V]$ . This is a contradiction to our hypothesis that  $k[V]$  was an integral domain. Hence,  $V$  is irreducible.

Finally, for (i)  $\Rightarrow$  (iii), suppose that  $k[V]$  is not an integral domain. Then there must be polynomials  $f, g \in k[x_1, \dots, x_n]$  such that neither  $f$  nor  $g$  vanishes identically on  $V$  but their product does. In Exercise 9, you will check that we get a decomposition of  $V$  as a union of subvarieties:

$$V = (V \cap \mathbf{V}(f)) \cup (V \cap \mathbf{V}(g)).$$

You will also show in Exercise 9 that, under these hypotheses, neither  $V \cap \mathbf{V}(f)$  nor  $V \cap \mathbf{V}(g)$  is all of  $V$ . This contradicts our assumption that  $V$  is irreducible.  $\square$

Next we will consider another example of the kind of information about varieties revealed by polynomial mappings. The variety  $V \subset \mathbb{C}^3$  defined by

$$(4) \quad \begin{aligned} x^2 + 2xz + 2y^2 + 3y &= 0, \\ xy + 2x + z &= 0, \\ xz + y^2 + 2y &= 0 \end{aligned}$$

is the intersection of three quadric surfaces.

To study  $V$ , we compute a Groebner basis for the ideal generated by the polynomials in (4), using the lexicographic order and the variable order  $y > z > x$ . The result is

$$(5) \quad \begin{aligned} g_1 &= y - x^2, \\ g_2 &= z + x^3 + 2x. \end{aligned}$$

Geometrically, by the results of Chapter 3, §2, we know that the projection of  $V$  on the  $x$ -axis is onto since the two polynomials in (5) have constant leading coefficients. Furthermore, for each value of  $x$  in  $\mathbb{C}$ , there are unique  $y, z$  satisfying equations (4).

We can rephrase this observation using the maps

$$\begin{aligned} \pi : V &\longrightarrow \mathbb{C}, (x, y, z) \mapsto x, \\ \phi : \mathbb{C} &\longrightarrow V, x \mapsto (x, x^2, -x^3 - 2x). \end{aligned}$$

Note that (5) guarantees that  $\phi$  takes values in  $V$ . Both  $\phi$  and  $\pi$  are visibly polynomial mappings. We claim that these maps establish a one-to-one correspondence between the points of the variety  $V$  and the points of the variety  $\mathbb{C}$ .

Our claim will follow if we can show that  $\pi$  and  $\phi$  are inverses of each other. To verify this last claim, we first check that  $\pi \circ \phi = \text{id}_{\mathbb{C}}$ . This is actually quite clear since

$$(\pi \circ \phi)(x) = \pi(x, x^2, -x^3 - 2x) = x.$$

On the other hand, if  $(x, y, z) \in V$ , then

$$(\phi \circ \pi)(x, y, z) = (x, x^2, -x^3 - 2x).$$

By (5), we have  $y - x^2, z + x^3 + 2x \in \mathbf{I}(V)$  and it follows that  $\phi \circ \pi$  defines the *same* mapping on  $V$  as  $\text{id}_V(x, y, z) = (x, y, z)$ .

The conclusion we draw from this example is that  $V \subset \mathbb{C}^3$  and  $\mathbb{C}$  are “isomorphic” varieties in the sense that there is a one-to-one, onto, polynomial mapping from  $V$  to  $\mathbb{C}$ , with a polynomial inverse. Even though our two varieties are defined by different equations and are subsets of different ambient spaces, they are “the same” in a certain sense. In addition, the Groebner basis calculation leading to equation (5) shows that  $\mathbb{C}[V] = \mathbb{C}[x]$ , in the sense that every  $\psi \in \mathbb{C}[V]$  can be (uniquely) expressed by substituting for  $y$  and  $z$  from (5) to yield a polynomial in  $x$  alone. Of course, if we use  $x$  as the coordinate on  $W = \mathbb{C}$ , then  $\mathbb{C}[W] = \mathbb{C}[x]$  as well, and we obtain the *same* collection of functions on our two isomorphic varieties.

Thus, the collection of polynomial functions on an affine variety can detect geometric properties such as reducibility or irreducibility. In addition, knowing the structure of  $k[V]$  can also furnish information leading toward the beginnings of a *classification* of varieties, a topic we have not broached before. We will return to these questions later in the chapter, once we have developed several different tools to analyze the algebraic properties of  $k[V]$ .

### EXERCISES FOR §1

- Let  $V$  be the twisted cubic in  $\mathbb{R}^3$  and let  $W = \mathbf{V}(v - u - u^2)$  in  $\mathbb{R}^2$ . Show that  $\phi(x, y, z) = (xy, z + x^2y^2)$  defines a polynomial mapping from  $V$  to  $W$ . Hint: The easiest way is to use a parametrization of  $V$ .
- Let  $V = \mathbf{V}(y - x)$  in  $\mathbb{R}^2$  and let  $\phi : \mathbb{R}^2 \rightarrow \mathbb{R}^3$  be the polynomial mapping represented by  $\phi(x, y) = (x^2 - y, y^2, x - 3y^2)$ . The image of  $V$  is a variety in  $\mathbb{R}^3$ . Find a system of equations defining the image of  $\phi$ .
- Given a polynomial function  $\phi : V \rightarrow k$ , we define a *level set* of  $\phi$  to be

$$\phi^{-1}(c) = \{(a_1, \dots, a_m) \in V : \phi(a_1, \dots, a_m) = c\},$$

where  $c \in k$  is fixed. In this exercise, we will investigate how level sets can be used to analyze and reconstruct a variety. We will assume that  $k = \mathbb{R}$ , and we will work with the surface

$$\mathbf{V}(x^2 - y^2z^2 + z^3) \subset \mathbb{R}^3.$$

- Let  $\phi$  be the polynomial function represented by  $f(x, y, z) = z$ . The image of  $\phi$  is all of  $\mathbb{R}$  in this case. For each  $c \in \mathbb{R}$ , explain why the level set  $\phi^{-1}(c)$  is the affine variety defined by the equations:

$$\begin{aligned} x^2 - y^2z^2 + z^3 &= 0, \\ z - c &= 0. \end{aligned}$$

- Eliminate  $z$  between these equations to find the equation of the intersection of  $V$  with the plane  $z = c$ . Explain why your equation defines a hyperbola in the plane  $z = c$  if  $c \neq 0$ , and the  $y$ -axis if  $c = 0$ . (Refer to the sketch of  $V$  in §3 of Chapter 1, and see if you can visualize the way these hyperbolas lie on  $V$ .)

- c. Let  $\pi : V \rightarrow \mathbb{R}$  be the polynomial mapping  $\pi(x, y, z) = x$ . Describe the level sets  $\pi^{-1}(c)$  in  $V$  geometrically for  $c = -1, 0, 1$ .
- d. Do the same for the level sets of  $\sigma : V \rightarrow \mathbb{R}$  given by  $\sigma(x, y, z) = y$ .
- e. Construct a polynomial mapping  $\psi : \mathbb{R}^3 \rightarrow V$  and identify the image as a subvariety of  $V$ .
4. Let  $V = \mathbf{V}(z^2 - (x^2 + y^2 - 1)(4 - x^2 - y^2))$  in  $\mathbb{R}^3$  and let  $\pi : V \rightarrow \mathbb{R}^2$  be the vertical projection  $\pi(x, y, z) = (x, y)$ .
- What is the maximum number of points in  $\pi^{-1}(a, b)$  for  $(a, b) \in \mathbb{R}^2$ ?
  - For which subsets  $R \subset \mathbb{R}^2$  does  $(a, b) \in R$  imply  $\pi^{-1}(a, b)$  consists of two points, one point, no points?
  - Using part (b) describe and/or sketch  $V$ .
5. Show that  $\phi_1(x, y, z) = (2x^2 + y^2, z^2 - y^3 + 3xz)$  and  $\phi_2(x, y, z) = (2y + xz, 3y^2)$  represent the same polynomial mapping from the twisted cubic in  $\mathbb{R}^3$  to  $\mathbb{R}^2$ .
6. Consider the mapping  $\phi : \mathbb{R}^2 \rightarrow \mathbb{R}^5$  defined by  $\phi(u, v) = (u, v, u^2, uv, v^2)$ .
- The image of  $\phi$  is a variety  $S$  known as an affine Veronese surface. Find implicit equations for  $S$ .
  - Show that the projection  $\pi : S \rightarrow \mathbb{R}^2$  defined by  $\pi(x_1, x_2, x_3, x_4, x_5) = (x_1, x_2)$  is the inverse mapping of  $\phi : \mathbb{R}^2 \rightarrow S$ . What does this imply about  $S$  and  $\mathbb{R}^2$ ?
7. This problem characterizes the varieties for which  $\mathbf{I}(V) = \{0\}$ .
- Show that if  $k$  is an infinite field and  $V \subset k^n$  is a variety, then  $\mathbf{I}(V) = \{0\}$  if and only if  $V = k^n$ .
  - On the other hand, show that if  $k$  is finite, then  $\mathbf{I}(V)$  is never equal to  $\{0\}$ . Hint: See Exercise 4 of Chapter 1, §1.
8. Let  $V = \mathbf{V}(xy, xz) \subset \mathbb{R}^3$ .
- Show that neither of the polynomial functions  $f = y^2 + z^3$ ,  $g = x^2 - x$  is identically zero on  $V$ , but that their product is identically zero on  $V$ .
  - Find  $V_1 = V \cap \mathbf{V}(f)$  and  $V_2 = V \cap \mathbf{V}(g)$  and show that  $V = V_1 \cup V_2$ .
9. Let  $V$  be an irreducible variety and let  $\phi, \psi$  be functions in  $k[V]$  represented by polynomials  $f, g$ , respectively. Suppose that  $\phi \cdot \psi = 0$  in  $k[V]$ , but that neither  $\phi$  nor  $\psi$  is the zero function on  $V$ .
- Show that  $V = (V \cap \mathbf{V}(f)) \cup (V \cap \mathbf{V}(g))$ .
  - Show that neither  $V \cap \mathbf{V}(f)$  nor  $V \cap \mathbf{V}(g)$  is all of  $V$  and deduce a contradiction.
10. In this problem, we will see that there are no nonconstant polynomial mappings from  $V = \mathbb{R}$  to  $W = \mathbf{V}(y^2 - x^3 + x) \subset \mathbb{R}^2$ . Thus, these varieties are not isomorphic (that is, they are not “the same” in the sense introduced in this section).
- Suppose  $\phi : \mathbb{R} \rightarrow W$  is a polynomial mapping represented by  $\phi(t) = (a(t), b(t))$  where  $a(t), b(t) \in \mathbb{R}[t]$ . Explain why it must be true that  $b(t)^2 = a(t)(a(t)^2 - 1)$ .
  - Explain why the two factors on the right of the equation in part (a) must be relatively prime in  $\mathbb{R}[t]$ .
  - Using the unique factorizations of  $a$  and  $b$  into products of powers of irreducible polynomials, show that  $b^2 = ac^2$  for some polynomial  $c(t) \in \mathbb{R}[t]$  relatively prime to  $a$ .
  - From part (c) it follows that  $c^2 = a^2 - 1$ . Deduce from this equation that  $c, a$ , and, hence,  $b$  must be constant polynomials.

## §2 Quotients of Polynomial Rings

The construction of  $k[V]$  given in §1 is a special case of what is called the quotient of  $k[x_1, \dots, x_n]$  modulo an ideal  $I$ . From the word *quotient*, you might guess that the issue is to define a division operation, but this is *not* the case. Instead, forming the quotient

will indicate the sort of “lumping together” of polynomials that we mentioned in §1 when describing the elements  $\phi \in k[V]$ . The quotient construction is a fundamental tool in commutative algebra and algebraic geometry, so if you pursue these subjects further, the acquaintance you make with quotient rings here will be valuable.

To begin, we introduce some new terminology.

**Definition 1.** Let  $I \subset k[x_1, \dots, x_n]$  be an ideal, and let  $f, g \in k[x_1, \dots, x_n]$ . We say  $f$  and  $g$  are **congruent modulo  $I$** , written

$$f \equiv g \pmod{I},$$

if  $f - g \in I$ .

For instance, if  $I = \langle x^2 - y^2, x + y^3 + 1 \rangle \subset k[x, y]$ , then  $f = x^4 - y^4 + x$  and  $g = x + x^5 + x^4y^3 + x^4$  are congruent modulo  $I$  since

$$\begin{aligned} f - g &= x^4 - y^4 - x^5 - x^4y^3 - x^4 \\ &= (x^2 + y^2)(x^2 - y^2) - (x^4)(x + y^3 + 1) \in I. \end{aligned}$$

The most important property of the congruence relation is given by the following proposition.

**Proposition 2.** Let  $I \subset k[x_1, \dots, x_n]$  be an ideal. Then congruence modulo  $I$  is an equivalence relation on  $k[x_1, \dots, x_n]$ .

**Proof.** Congruence modulo  $I$  is reflexive since  $f - f = 0 \in I$  for every  $f \in k[x_1, \dots, x_n]$ . To prove symmetry, suppose that  $f \equiv g \pmod{I}$ . Then  $f - g \in I$ , which implies that  $g - f = (-1)(f - g) \in I$  as well. Hence,  $g \equiv f \pmod{I}$  also. Finally, we need to consider transitivity. If  $f \equiv g \pmod{I}$  and  $g \equiv h \pmod{I}$ , then  $f - g, g - h \in I$ . Since  $I$  is closed under addition, we have  $f - h = f - g + g - h \in I$  as well. Hence,  $f \equiv h \pmod{I}$ .  $\square$

An equivalence relation on a set  $S$  partitions  $S$  into a collection of disjoint subsets called equivalence classes. For any  $f \in k[x_1, \dots, x_n]$ , the class of  $f$  is the set

$$[f] = \{g \in k[x_1, \dots, x_n] : g \equiv f \pmod{I}\}.$$

The definition of congruence modulo  $I$  and Proposition 2 makes sense for every ideal  $I \subset k[x_1, \dots, x_n]$ . In the special case that  $I = \mathbf{I}(V)$  is the ideal of the variety  $V$ , then by Proposition 2 of §1, it follows that  $f \equiv g \pmod{\mathbf{I}(V)}$  if and only if  $f$  and  $g$  define the same function on  $V$ . In other words, the “lumping together” of polynomials that define the same function on a variety  $V$  is accomplished by passing to the equivalence classes for the congruence relation modulo  $\mathbf{I}(V)$ . More formally, we have the following proposition.

**Proposition 3.** The distinct polynomial functions  $\phi : V \rightarrow k$  are in one-to-one correspondence with the equivalence classes of polynomials under congruence modulo  $\mathbf{I}(V)$ .

**Proof.** This is a corollary of Proposition 2 of §1 and the (easy) proof is left to the reader as an exercise.  $\square$

We are now ready to introduce the quotients mentioned in the title of this section.

**Definition 4.** The **quotient** of  $k[x_1, \dots, x_n]$  modulo  $I$ , written  $k[x_1, \dots, x_n]/I$ , is the set of equivalence classes for congruence modulo  $I$ :

$$k[x_1, \dots, x_n]/I = \{[f] : f \in k[x_1, \dots, x_n]\}.$$

For instance, take  $k = \mathbb{R}, n = 1$ , and  $I = \langle x^2 - 2 \rangle$ . We may ask whether there is some way to describe all the equivalence classes for congruence modulo  $I$ . By the division algorithm, every  $f \in \mathbb{R}[x]$  can be written as  $f = q \cdot (x^2 - 2) + r$ , where  $r = ax + b$  for some  $a, b \in \mathbb{R}$ . By the definition,  $f \equiv r \pmod I$  since  $f - r = q \cdot (x^2 - 2) \in I$ . Thus, every element of  $\mathbb{R}[x]$  belongs to one of the equivalence classes  $[ax + b]$ , and  $\mathbb{R}[x]/I = \{[ax + b] : a, b \in \mathbb{R}\}$ . In §3, we will extend the idea used in this example to a method for dealing with  $k[x_1, \dots, x_n]/I$  in general.

Because  $k[x_1, \dots, x_n]$  is a ring, given any two classes  $[f], [g] \in k[x_1, \dots, x_n]/I$ , we can attempt to define sum and product operations *on classes* by using the corresponding operations on elements of  $k[x_1, \dots, x_n]$ . That is, we can try to define

$$(1) \quad \begin{aligned} [f] + [g] &= [f + g] && \text{(sum in } k[x_1, \dots, x_n]), \\ [f] \cdot [g] &= [f \cdot g] && \text{(product in } k[x_1, \dots, x_n]). \end{aligned}$$

We must check, however, that these formulas actually make sense. We need to show that if we choose different  $f' \in [f]$  and  $g' \in [g]$ , then the class  $[f' + g']$  is the same as the class  $[f + g]$ . Similarly, we need to check that  $[f' \cdot g'] = [f \cdot g]$ .

**Proposition 5.** The operations defined in equations (1) yields the same classes in  $k[x_1, \dots, x_n]/I$  on the right-hand sides no matter which  $f' \in [f]$  and  $g' \in [g]$  we use. (We say that the operations on classes given in (1) are **well-defined** on classes.)

**Proof.** If  $f' \in [f]$  and  $g' \in [g]$ , then  $f' = f + a$  and  $g' = g + b$ , where  $a, b \in I$ . Hence,

$$f' + g' = (f + a) + (g + b) = (f + g) + (a + b).$$

Since we also have  $a + b \in I$  ( $I$  is an ideal), it follows that  $f' + g' \equiv f + g \pmod I$ , so  $[f' + g'] = [f + g]$ . Similarly,

$$f' \cdot g' = (f + a) \cdot (g + b) = fg + ag + fb + ab.$$

Since  $a, b \in I$ , we have  $ag + fb + ab \in I$ . Thus,  $f' \cdot g' \equiv f \cdot g \pmod I$ , so  $[f' \cdot g'] = [f \cdot g]$ .  $\square$

To illustrate this result, consider the sum and product operations in  $\mathbb{R}[x]/\langle x^2 - 2 \rangle$ . As we saw earlier, the classes  $[ax + b], a, b \in \mathbb{R}$  form a complete list of the elements of



$\mathbb{R}[x]/\langle x^2-2 \rangle$ . The sum operation is defined by  $[ax+b]+[cx+d] = [(a+c)x+(b+d)]$ . Note that this amounts to the usual vector sum on ordered pairs of real numbers. The product operation is also easily understood. We have

$$\begin{aligned} [ax+b] \cdot [cx+d] &= [acx^2 + (ad+bc)x + bd] \\ &= [(ad+bc)x + (bd+2ac)], \end{aligned}$$

as we can see by dividing the quadratic polynomial in the first line by  $x^2 - 2$  and using the remainder as our representative of the class of the product.

Once we know that the operations in (1) are well-defined, it follows immediately that all of the axioms for a commutative ring are satisfied in  $k[x_1, \dots, x_n]/I$ . This is so because the sum and product in  $k[x_1, \dots, x_n]/I$  are defined in terms of the corresponding operations in  $k[x_1, \dots, x_n]$ , where we know that the axioms do hold. For example, to check that sums are associative in  $k[x_1, \dots, x_n]/I$ , we argue as follows: if  $[f], [g], [h] \in k[x_1, \dots, x_n]/I$ , then

$$\begin{aligned} ([f] + [g]) + [h] &= [f + g] + [h] \\ &= [(f + g) + h] \quad \text{[by (1)]} \\ &= [f + (g + h)] \quad \text{(by associativity in } k[x_1, \dots, x_n]) \\ &= [f] + [g + h] \\ &= [f] + ([g] + [h]). \end{aligned}$$

Similarly, commutativity of addition, associativity, and commutativity of multiplication, and the distributive law all follow because polynomials satisfy these properties. The additive identity is  $[0] \in k[x_1, \dots, x_n]/I$ , and the multiplicative identity is  $[1] \in k[x_1, \dots, x_n]/I$ . To summarize, we have sketched the proof of the following theorem.

**Theorem 6.** *Let  $I$  be an ideal in  $k[x_1, \dots, x_n]$ . The quotient  $k[x_1, \dots, x_n]/I$  is a commutative ring under the sum and product operations given in (1).*

Next, given a variety  $V$ , we would like to relate the quotient ring  $k[x_1, \dots, x_n]/\mathbf{I}(V)$  to the ring  $k[V]$  of polynomial functions on  $V$ . It turns out that these two rings are “the same” in the following sense.

**Theorem 7.** *The one-to-one correspondence between the elements of  $k[V]$  and the elements of  $k[x_1, \dots, x_n]/\mathbf{I}(V)$  given in Proposition 3 preserves sums and products.*

**Proof.** Let  $\Phi : k[x_1, \dots, x_n]/\mathbf{I}(V) \rightarrow k[V]$  be the mapping defined by  $\Phi([f]) = \phi$ , where  $\phi$  is the polynomial function represented by  $f$ . Since every element of  $k[V]$  is represented by some polynomial, we see that  $\Phi$  is onto. To see that  $\Phi$  is also one-to-one, suppose that  $\Phi([f]) = \Phi([g])$ . Then by Proposition 3,  $f \equiv g \pmod{\mathbf{I}(V)}$ . Hence,  $[f] = [g]$  in  $k[x_1, \dots, x_n]/\mathbf{I}(V)$ .

To study sums and products, let  $[f], [g] \in k[x_1, \dots, x_n]/\mathbf{I}(V)$ . Then  $\Phi([f]+[g]) = \Phi([f+g])$  by the definition of sum in the quotient ring. If  $f$  represents the polynomial

function  $\phi$  and  $g$  represents  $\psi$ , then  $f + g$  represents  $\phi + \psi$ . Hence,

$$\Phi([f + g]) = \phi + \psi = \Phi([f]) + \Phi([g]).$$

Thus,  $\Phi$  preserves sums. Similarly,

$$\Phi([f] \cdot [g]) = \Phi([f \cdot g]) = \phi \cdot \psi = \Phi([f]) \cdot \Phi([g]).$$

Thus,  $\Phi$  preserves products as well.

The inverse correspondence  $\Psi$  also preserves sums and products by a similar argument, and the theorem is proved.  $\square$

The result of Theorem 7 illustrates a basic notion from abstract algebra. The following definition tells us what it means for two rings to be essentially the same.

**Definition 8.** Let  $R, S$  be commutative rings.

- (i) A mapping  $\phi : R \rightarrow S$  is said to be a **ring isomorphism** if:
  - a.  $\phi$  preserves sums:  $\phi(r + r') = \phi(r) + \phi(r')$  for all  $r, r' \in R$ .
  - b.  $\phi$  preserves products:  $\phi(r \cdot r') = \phi(r) \cdot \phi(r')$  for all  $r, r' \in R$ .
  - c.  $\phi$  is one-to-one and onto.
- (ii) Two rings  $R, S$  are **isomorphic** if there exists an isomorphism  $\phi : R \rightarrow S$ . We write  $R \cong S$  to denote that  $R$  is isomorphic to  $S$ .
- (iii) A mapping  $\phi : R \rightarrow S$  is a **ring homomorphism** if  $\phi$  satisfies properties (a) and (b) of (i), but not necessarily property (c), and if, in addition,  $\phi$  maps the multiplicative identity  $1 \in R$  to  $1 \in S$ .

In general, a “homomorphism” is a mapping that preserves algebraic structure. A ring homomorphism  $\phi : R \rightarrow S$  is a mapping that preserves the addition and multiplication operations in the ring  $R$ .

From Theorem 7, we get a ring isomorphism  $k[V] \cong k[x_1, \dots, x_n]/\mathbf{I}(V)$ . A natural question to ask is what happens if we replace  $\mathbf{I}(V)$  by some other ideal  $I$  which defines  $V$ . [From Chapter 4, we know that there are *lots* of ideals  $I$  such that  $V = \mathbf{V}(I)$ .] Could it be true that *all* the quotient rings  $k[x_1, \dots, x_n]/I$  are isomorphic to  $k[V]$ ? The following example shows that the answer to this question is *no*. Let  $V = \{(0, 0)\}$ . We saw in Chapter 1, §4 that  $\mathbf{I}(V) = \mathbf{I}(\{(0, 0)\}) = \langle x, y \rangle$ . Thus, by Theorem 7, we have  $k[x, y]/\mathbf{I}(V) \cong k[V]$ .

Our first claim is that the quotient ring  $k[x, y]/\mathbf{I}(V)$  is isomorphic to the field  $k$ . The easiest way to see this is to note that a polynomial function on the one-point set  $\{(0, 0)\}$  can be represented by a constant since the function will have only one function value. Alternatively, we can derive the same fact algebraically by constructing a mapping

$$\Phi : k[x, y]/\mathbf{I}(V) \longrightarrow k$$

by setting  $\Phi([f]) = f(0, 0)$  (the constant term of the polynomial). We will leave it as an exercise to show that  $\Phi$  is a ring isomorphism.

Now, let  $I = \langle x^3 + y^2, 3y^4 \rangle \subset k[x, y]$ . It is easy to check that  $\mathbf{V}(I) = \{(0, 0)\} = V$ . We ask whether  $k[x, y]/I$  is also isomorphic to  $k$ . A moment’s thought shows that this is not so. For instance, consider the class  $[y] \in k[x, y]/I$ . Note that  $y \notin I$ , a fact

which can be checked by finding a Groebner basis for  $I$  (use any monomial order) and computing a remainder. In the ring  $k[x, y]/I$ , this shows that  $[y] \neq [0]$ . But we also have  $[y]^4 = [y^4] = [0]$  since  $y^4 \in I$ . Thus, there is an element of  $k[x, y]/I$  which is not zero itself, but whose fourth power is zero. In a field, this is impossible. We conclude that  $k[x, y]/I$  is not a field. But this says that  $k[x, y]/\mathbf{I}(V)$  and  $k[x, y]/I$  cannot be isomorphic rings since one is a field and the other is not. (See Exercise 8.)

In a commutative ring  $R$ , an  $a \in R$  such that  $a^n = 0$  for some  $n \geq 1$  is called a *nilpotent element*. The example just given is actually quite representative of the kind of difference that can appear when we compare  $k[x_1, \dots, x_n]/\mathbf{I}(V)$  with  $k[x_1, \dots, x_n]/I$  for another ideal  $I$  with  $\mathbf{V}(I) = V$ . If  $I$  is not a radical ideal, there will be elements  $f \in \sqrt{I}$  which are not in  $I$  itself. Thus, in  $k[x_1, \dots, x_n]/I$ , we will have  $[f] \neq [0]$ , whereas  $[f]^n = [0]$  for the  $n > 1$  such that  $f^n \in I$ . The ring  $k[x_1, \dots, x_n]/I$  will have nonzero nilpotent elements, whereas  $k[x_1, \dots, x_n]/\mathbf{I}(V)$  never does.  $\mathbf{I}(V)$  is always a radical ideal, so  $[f]^n = 0$  if and only if  $[f] = 0$ .

Since a quotient  $k[x_1, \dots, x_n]/I$  is a commutative ring in its own right, we can study other facets of its ring structure as well, and, in particular, we can consider ideals in  $k[x_1, \dots, x_n]/I$ . The definition is the same as the definition of ideals in  $k[x_1, \dots, x_n]$ .

**Definition 9.** A subset  $I$  of a commutative ring  $R$  is said to be an **ideal** in  $R$  if it satisfies

- (i)  $0 \in I$  (where  $0$  is the zero element of  $R$ ).
- (ii) If  $a, b \in I$ , then  $a + b \in I$ .
- (iii) If  $a \in I$  and  $r \in R$ , then  $r \cdot a \in I$ .

There is a close relation between ideals in the quotient  $k[x_1, \dots, x_n]/I$  and ideals in  $k[x_1, \dots, x_n]$ .

**Proposition 10.** Let  $I$  be an ideal in  $k[x_1, \dots, x_n]$ . The ideals in the quotient ring  $k[x_1, \dots, x_n]/I$  are in one-to-one correspondence with the ideals of  $k[x_1, \dots, x_n]$  containing  $I$  (that is, the ideals  $J$  satisfying  $I \subset J \subset k[x_1, \dots, x_n]$ ).

**Proof.** First, we give a way to produce an ideal in  $k[x_1, \dots, x_n]/I$  corresponding to each  $J$  containing  $I$  in  $k[x_1, \dots, x_n]$ . Given an ideal  $J$  in  $k[x_1, \dots, x_n]$  containing  $I$ , let  $J/I$  denote the set  $\{[j] \in k[x_1, \dots, x_n]/I : j \in J\}$ . We claim that  $J/I$  is an ideal in  $k[x_1, \dots, x_n]/I$ . To prove this, first note that  $[0] \in J/I$  since  $0 \in J$ . Next, let  $[j], [k] \in J/I$ . Then  $[j] + [k] = [j + k]$  by the definition of the sum in  $k[x_1, \dots, x_n]/I$ . Since  $j, k \in J$ , we have  $j + k \in J$  as well. Hence,  $[j] + [k] \in J/I$ . Finally, if  $[j] \in J/I$  and  $[r] \in k[x_1, \dots, x_n]/I$ , then  $[r] \cdot [j] = [r \cdot j]$  by the definition of the product in  $k[x_1, \dots, x_n]/I$ . But  $r \cdot j \in J$  since  $J$  is an ideal in  $k[x_1, \dots, x_n]$ . Hence,  $[r] \cdot [j] \in J/I$ . As a result,  $J/I$  is an ideal in  $k[x_1, \dots, x_n]/I$ .

If  $\tilde{J} \subset k[x_1, \dots, x_n]/I$  is an ideal, we next show how to produce an ideal  $J \subset k[x_1, \dots, x_n]$  which contains  $I$ . Let  $J = \{j \in k[x_1, \dots, x_n] : [j] \in \tilde{J}\}$ . Then we have  $I \subset J$  since  $[i] = [0] \in \tilde{J}$  for any  $i \in I$ . It remains to show that  $J$  is an ideal of  $k[x_1, \dots, x_n]$ . First note that  $0 \in I \subset J$ . Furthermore, if  $j, k \in J$ , then  $[j], [k] \in \tilde{J}$  implies that  $[j] + [k] = [j + k] \in \tilde{J}$ . It follows that  $j + k \in J$ . Finally, if  $j \in J$  and

$r \in k[x_1, \dots, x_n]$ , then  $[j] \in \tilde{J}$ , so  $[r][j] = [rj] \in \tilde{J}$ . But this says  $rj \in J$ , and, hence,  $J$  is an ideal in  $k[x_1, \dots, x_n]$ .

We have thus shown that there are correspondences between the two collections of ideals:

$$(2) \quad \begin{array}{ccc} \{J : I \subset J \subset k[x_1, \dots, x_n]\} & & \{\tilde{J} \subset k[x_1, \dots, x_n]/I\} \\ & J \longrightarrow & J/I = \{[j] : j \in J\} \\ & J = \{j : [j] \in \tilde{J}\} \longleftarrow & \tilde{J}. \end{array}$$

We leave it as an exercise to prove that each of these arrows is the inverse of the other. This gives the desired one-to-one correspondence.  $\square$

For example, consider the ideal  $I = \langle x^2 - 4x + 3 \rangle$  in  $R = \mathbb{R}[x]$ . We know from Chapter 1 that  $R$  is a principal ideal domain. That is, every ideal in  $R$  is generated by a single polynomial. The ideals containing  $I$  are precisely the ideals generated by polynomials that *divide*  $x^2 - 4x + 3$ . Hence, the quotient ring  $R/I$  has exactly four ideals in this case:

ideals in $R/I$	ideals in $R$ containing $I$
$\{[0]\}$	$I$
$\langle [x - 1] \rangle$	$\langle x - 1 \rangle$
$\langle [x - 3] \rangle$	$\langle x - 3 \rangle$
$R/I$	$R$

As in another example earlier in this section, we can compute in  $R/I$  by computing remainders with respect to  $x^2 - 4x + 3$ .

As a corollary of Proposition 10, we deduce the following result about ideals in quotient rings, parallel to the Hilbert Basis Theorem from Chapter 2.

**Corollary 11.** *Every ideal in the quotient ring  $k[x_1, \dots, x_n]/I$  is finitely generated.*

**Proof.** Let  $\tilde{J}$  be any ideal in  $k[x_1, \dots, x_n]/I$ . By Proposition 10,  $\tilde{J} = \{[j] : j \in J\}$  for an ideal  $J$  in  $k[x_1, \dots, x_n]$  containing  $I$ . Then the Hilbert Basis Theorem implies that  $J = \langle f_1, \dots, f_s \rangle$  for some  $f_i \in k[x_1, \dots, x_n]$ . But then for any  $j \in J$ , we have  $j = h_1 f_1 + \dots + h_s f_s$  for some  $h_i \in k[x_1, \dots, x_n]$ . Hence,

$$\begin{aligned} [j] &= [h_1 f_1 + \dots + h_s f_s] \\ &= [h_1][f_1] + \dots + [h_s][f_s]. \end{aligned}$$

As a result, the classes  $[f_1], \dots, [f_s]$  generate  $\tilde{J}$  in  $k[x_1, \dots, x_n]/I$ .  $\square$

In the next section, we will discuss a more constructive method to study the quotient rings  $k[x_1, \dots, x_n]/I$  and their algebraic properties.

**EXERCISES FOR §2**

1. Let  $I = \langle f_1, \dots, f_s \rangle \subset k[x_1, \dots, x_n]$ . Describe an algorithm for determining whether  $f \equiv g \pmod I$  using techniques from Chapter 2.
2. Prove Proposition 3.
3. Prove Theorem 6. That is, show that the other axioms for a commutative ring are satisfied by  $k[x_1, \dots, x_n]/I$ .
4. In this problem, we will give an algebraic construction of a field containing  $\mathbb{Q}$  in which 2 has a square root. Note that the field of real numbers is one such field. However, our construction will not make use of the *limit* process necessary, for example, to make sense of an infinite decimal expansion such as the usual expansion  $\sqrt{2} = 1.414\dots$ . Instead, we will work with the polynomial  $x^2 - 2$ .
  - a. Show that every  $f \in \mathbb{Q}[x]$  is congruent modulo the ideal  $I = \langle x^2 - 2 \rangle \subset \mathbb{Q}[x]$  to a unique polynomial of the form  $ax + b$ , where  $a, b \in \mathbb{Q}$ .
  - b. Show that the class of  $x$  in  $\mathbb{Q}[x]/I$  is a square root of 2 in the sense that  $[x]^2 = [2]$  in  $\mathbb{Q}[x]/I$ .
  - c. Show that  $F = \mathbb{Q}[x]/I$  is a field. Hint: Using Theorem 6, the only thing left to prove is that every nonzero element of  $F$  has a multiplicative inverse in  $F$ .
  - d. Find a subfield of  $F$  isomorphic to  $\mathbb{Q}$ .
5. In this problem, we will consider the addition and multiplication operations in the quotient ring  $\mathbb{R}[x]/\langle x^2 + 1 \rangle$ .
  - a. Show that every  $f \in \mathbb{R}[x]$  is congruent modulo  $I = \langle x^2 + 1 \rangle$  to a unique polynomial of the form  $ax + b$ , where  $a, b \in \mathbb{R}$ .
  - b. Construct formulas for the addition and multiplication rules in  $\mathbb{R}[x]/\langle x^2 + 1 \rangle$  using these polynomials as the standard representatives for classes.
  - c. Do we know another way to describe the ring  $\mathbb{R}[x]/\langle x^2 + 1 \rangle$  (that is, another well-known ring isomorphic to this one?). Hint: What is  $[x]^2$ ?
6. Show that  $\mathbb{R}[x]/\langle x^2 - 4x + 3 \rangle$  is not an integral domain.
7. It is possible to define a quotient ring  $R/I$  whenever  $I$  is an ideal in a commutative ring  $R$ . The general construction is the same as the one we have given for  $k[x_1, \dots, x_n]/I$ . Here is one simple example.
  - a. Let  $I = \langle p \rangle$  in  $R = \mathbb{Z}$ , where  $p$  is a prime number. Show that the relation of congruence modulo  $p$ , defined by

$$m \equiv n \pmod p \iff p \text{ divides } m - n$$

is an equivalence relation on  $\mathbb{Z}$ , and list the different equivalence classes. We will denote the set of equivalence classes by  $\mathbb{Z}/\langle p \rangle$ .

- b. Construct sum and product operations in  $\mathbb{Z}/\langle p \rangle$  by the analogue of equation (1) and then prove that they are well-defined by adapting the proof of Proposition 5.
  - c. Explain why  $\mathbb{Z}/\langle p \rangle$  is a commutative ring under the operations you defined in part (b).
  - d. Show that the finite field  $\mathbb{F}_p$  introduced in Chapter 1 is isomorphic as a ring to  $\mathbb{Z}/\langle p \rangle$ .
8. In this problem, we study how ring homomorphisms interact with multiplicative inverses in a ring.
  - a. Show that every ring isomorphism  $\phi : R \rightarrow S$  takes the multiplicative identity in  $R$  to the multiplicative identity in  $S$ , that is  $\phi(1) = 1$ .
  - b. Show that if  $r \in R$  has a multiplicative inverse, then for any ring homomorphism  $\phi : R \rightarrow S$ ,  $\phi(r^{-1})$  is a multiplicative inverse for  $\phi(r)$  in the ring  $S$ .
  - c. Show that if  $R$  and  $S$  are isomorphic as rings and  $R$  is a field, then  $S$  is also a field.

9. Prove that the map  $f \mapsto f(0, 0)$  induces a ring isomorphism  $k[x, y]/\langle x, y \rangle \cong k$ . Hint: An efficient proof can be given using Exercise 16.
10. This problem illustrates one important use of nilpotent elements in rings. Let  $R = k[x]$  and let  $I = \langle x^2 \rangle$ .
- Show that  $[x]$  is a nilpotent element in  $R/I$  and find the smallest power of  $[x]$  which is equal to zero.
  - Show that every class in  $R/I$  has a unique representative of the form  $b + a\epsilon$ , where  $a, b \in k$  and  $\epsilon$  is shorthand for  $[x]$ .
  - Given  $b + a\epsilon \in R/I$ , we can define a mapping  $R \rightarrow R/I$  by substituting  $x = b + a\epsilon$  in each element  $f(x) \in R$ . For instance, with  $b + a\epsilon = 2 + \epsilon$  and  $f(x) = x^2$ , we obtain  $(2 + \epsilon)^2 = 4 + 4\epsilon + \epsilon^2 = 4\epsilon + 4$ . Show that
 
$$(3) \quad f(b + a\epsilon) = f(b) + a \cdot f'(b)\epsilon,$$
 where  $f'$  is the formal derivative of the polynomial  $f$ . (Thus, derivatives of polynomials can be constructed in a purely algebraic way.)
  - Suppose  $\epsilon = [x] \in k[x]/\langle x^3 \rangle$ . Derive a formula analogous to (3) for  $f(b + a\epsilon)$ .
11. Let  $R$  be a commutative ring. Show that the set of nilpotent elements of  $R$  forms an ideal in  $R$ . Hint: To show that the sum of two nilpotent elements is also nilpotent, you can expand a suitable power  $(a + b)^k$  using the distributive law. The result is formally the same as the usual binomial expansion.
12. This exercise will show that the two mappings given in (2) are inverses of each other.
- If  $I \subset J$  is an ideal of  $k[x_1, \dots, x_n]$ , show that  $J = \{f \in k[x_1, \dots, x_n] : [f] \in J/I\}$ , where  $J/I = \{[j] : j \in J\}$ . Explain how your proof uses the assumption  $I \subset J$ .
  - If  $\bar{J}$  is an ideal of  $k[x_1, \dots, x_n]/I$ , show that  $\bar{J} = \{[f] \in k[x_1, \dots, x_n]/I : f \in J\}$ , where  $J = \{j : [j] \in \bar{J}\}$ .
13. Let  $R$  and  $S$  be commutative rings and let  $\phi : R \rightarrow S$  be a ring homomorphism.
- If  $J \subset S$  is an ideal, show that  $\phi^{-1}(J)$  is an ideal in  $R$ .
  - If  $\phi$  is an isomorphism of rings, show that there is a one-to-one, inclusion-preserving correspondence between the ideals of  $R$  and the ideals of  $S$ .
14. This problem studies the ideals in some quotient rings.
- Let  $I = \langle x^3 - x \rangle \subset R = \mathbb{R}[x]$ . Determine the ideals in the quotient ring  $R/I$  using Proposition 10. Draw a diagram indicating which of these ideals are contained in which others.
  - How does your answer change if  $I = \langle x^3 + x \rangle$ ?
15. This problem considers some special quotient rings of  $\mathbb{R}[x, y]$ .
- Let  $I = \langle x^2, y^2 \rangle \subset \mathbb{R}[x, y]$ . Describe the ideals in  $\mathbb{R}[x, y]/I$ . Hint: Use Proposition 10.
  - Is  $\mathbb{R}[x, y]/\langle x^3, y \rangle$  isomorphic to  $\mathbb{R}[x, y]/\langle x^2, y^2 \rangle$ ?
16. Let  $\phi : k[x_1, \dots, x_n] \rightarrow S$  be a ring homomorphism. The set  $\{r \in k[x_1, \dots, x_n] : \phi(r) = 0 \in S\}$  is called the *kernel* of  $\phi$ , written  $\ker(\phi)$ .
- Show that  $\ker(\phi)$  is an ideal in  $k[x_1, \dots, x_n]$ .
  - Show that the mapping  $v$  from  $k[x_1, \dots, x_n]/\ker(\phi)$  to  $S$  defined by  $v([r]) = \phi(r)$  is well-defined in the sense that  $v([r]) = v([r'])$  whenever  $r \equiv r' \pmod{\ker(\phi)}$ .
  - Show that  $v$  is a ring homomorphism.
  - (The Isomorphism Theorem) Assume that  $\phi$  is onto. Show that  $v$  is a one-to-one and onto ring homomorphism. As a result, we have  $S \cong k[x_1, \dots, x_n]/\ker(\phi)$  when  $\phi : k[x_1, \dots, x_n] \rightarrow S$  is onto.
17. Use Exercise 16 to give a more concise proof of Theorem 7. Consider the mapping  $\phi : k[x_1, \dots, x_n] \rightarrow k[V]$  that takes a polynomial to the element of  $k[V]$  that it represents. Hint: What is the kernel of  $\phi$ ?

### §3 Algorithmic Computations in $k[x_1, \dots, x_n]/I$

In this section, we will use the division algorithm to produce simple representatives of equivalence classes for congruence modulo  $I$ , where  $I \subset k[x_1, \dots, x_n]$  is an ideal. These representatives will enable us to develop an explicit method for computing the sum and product operations in a quotient ring  $k[x_1, \dots, x_n]/I$ . As an added dividend, we will derive an easily checked criterion to determine when a system of polynomial equations over  $\mathbb{C}$  has only *finitely many* solutions.

The basic idea that we will use is a direct consequence of the fact that the remainder on division of a polynomial  $f$  by a *Groebner basis*  $G$  for an ideal  $I$  is uniquely determined by the polynomial  $f$ . (This was Proposition 1 of Chapter 2, §6.) Furthermore, we have the following basic observations reinterpreting the result of the division and the form of the remainder.

**Proposition 1.** Fix a monomial ordering on  $k[x_1, \dots, x_n]$  and let  $I \subset k[x_1, \dots, x_n]$  be an ideal. As in Chapter 2, §5,  $\langle \text{LT}(I) \rangle$  will denote the ideal generated by the leading terms of elements of  $I$ .

- (i) Every  $f \in k[x_1, \dots, x_n]$  is congruent modulo  $I$  to a unique polynomial  $r$  which is a  $k$ -linear combination of the monomials in the complement of  $\langle \text{LT}(I) \rangle$ .
- (ii) The elements of  $\{x^\alpha : x^\alpha \notin \langle \text{LT}(I) \rangle\}$  are “linearly independent modulo  $I$ .” That is, if

$$\sum_{\alpha} c_{\alpha} x^{\alpha} \equiv 0 \pmod{I},$$

where the  $x^\alpha$  are all in the complement of  $\langle \text{LT}(I) \rangle$ , then  $c_\alpha = 0$  for all  $\alpha$ .

**Proof.** (i) Let  $G$  be a Groebner basis for  $I$  and let  $f \in k[x_1, \dots, x_n]$ . By the division algorithm, the remainder  $r = \overline{f}^G$  satisfies  $f = q + r$ , where  $q \in I$ . Hence,  $f - r = q \in I$ , so  $f \equiv r \pmod{I}$ . The division algorithm also tells us that  $r$  is a  $k$ -linear combination of the monomials  $x^\alpha \notin \langle \text{LT}(I) \rangle$ . The uniqueness of  $r$  follows from Proposition 1 of Chapter 2, §6.

(ii) The argument to establish this part of the proposition is essentially the same as the proof of the uniqueness of the remainder in Proposition 1 of Chapter 2, §6. We leave it to the reader to carry out the details.  $\square$

Historically, this was actually the first application of Groebner bases. Buchberger’s thesis concerned the question of finding “standard sets of representatives” for the classes in quotient rings. We also note that if  $I = \mathbf{I}(V)$  for a variety  $V$ , Proposition 1 gives standard representatives for the polynomial functions  $\phi \in k[V]$ .

**Example 2.** Let  $I = \langle xy^3 - x^2, x^3y^2 - y \rangle$  in  $\mathbb{R}[x, y]$  and use graded lex order. We find that

$$G = \{x^3y^2 - y, x^4 - y^2, xy^3 - x^2, y^4 - xy\}$$

is a Groebner basis for  $I$ . Hence,  $\langle \text{LT}(I) \rangle = \langle x^3y^2, x^4, xy^3, y^4 \rangle$ . As in Chapter 2, §4, we can draw a diagram in  $\mathbb{Z}_{\geq 0}^2$  to represent the exponent vectors of the monomials in  $\langle \text{LT}(I) \rangle$  and its complement as follows. The vectors

$$\begin{aligned} \alpha(1) &= (3, 2), \\ \alpha(2) &= (4, 0), \\ \alpha(3) &= (1, 3), \\ \alpha(4) &= (0, 4) \end{aligned}$$

are the exponent vectors of the generators of  $\langle \text{LT}(I) \rangle$ . Thus, the elements of

$$((3, 2) + \mathbb{Z}_{\geq 0}^2) \cup ((4, 0) + \mathbb{Z}_{\geq 0}^2) \cup ((1, 3) + \mathbb{Z}_{\geq 0}^2) \cup ((0, 4) + \mathbb{Z}_{\geq 0}^2)$$

are the exponent vectors of monomials in  $\langle \text{LT}(I) \rangle$ . As a result, we can represent the monomials in  $\langle \text{LT}(I) \rangle$  by the integer points in the shaded region in  $\mathbb{Z}_{\geq 0}^2$  given below:

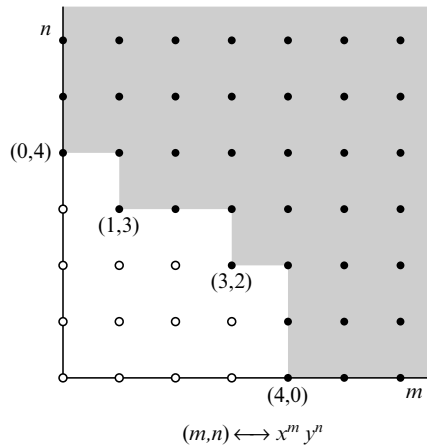

Given any  $f \in \mathbb{R}[x, y]$ . Proposition 1 implies that the remainder  $\overline{f}^G$  will be a  $\mathbb{R}$ -linear combination of the 12 monomials  $1, x, x^2, x^3, y, xy, x^2y, x^3y, y^2, xy^2, x^2y^2, y^3$  not contained in the shaded region. Note that in this case the remainders all belong to a finite-dimensional vector subspace of  $\mathbb{R}[x, y]$ .

We may also ask what happens if we use a different monomial order in  $\mathbb{R}[x, y]$  with the same ideal. If we use lex order instead of grlex, with the variables ordered  $y > x$ , we find that a Groebner basis in this case is

$$G = \{y - x^7, x^{12} - x^2\}.$$

Hence, for this monomial order,  $\langle \text{LT}(I) \rangle = \langle y, x^{12} \rangle$ , and  $\langle \text{LT}(I) \rangle$  contains all the monomials with exponent vectors in the shaded region on the next page. Thus, for every  $f \in \mathbb{R}[x, y]$ , we see that  $\overline{f}^G \in \text{Span}(1, x, x^2, \dots, x^{11})$ .



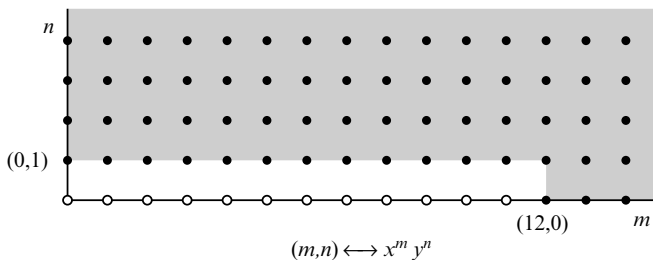

Note that  $\langle LT(I) \rangle$  and the remainders can be completely different depending on which monomial order we use. In both cases, however, the possible remainders form the elements of a 12-dimensional vector space. The fact that the dimension is the same in both cases is no accident, as we will soon see. No matter what monomial order we use, for a given ideal  $I$ , we will always find the same *number* of monomials in the complement of  $\langle LT(I) \rangle$  (in the case that this number is finite).

**Example 3.** For the ideal considered in Example 2, there were only finitely many monomials in the complement of  $\langle LT(I) \rangle$ . This is actually a very special situation. For instance, consider  $I = \langle x - z^2, y - z^3 \rangle \subset k[x, y, z]$ . Using lex order, the given generators for  $I$  already form a Groebner basis, so that  $\langle LT(I) \rangle = \langle x, y \rangle$ . The set of possible remainders modulo  $I$  is thus the set of all  $k$ -linear combinations of the powers of  $z$ . In this case, we recognize  $I$  as the ideal of a twisted cubic curve in  $k^3$ . As a result of Proposition 1, we see that every polynomial function on the twisted cubic can be uniquely represented by a polynomial in  $k[z]$ . Hence, the space of possible remainders is not finite-dimensional and  $\mathbf{V}(I)$  is a curve. What can you say about  $\mathbf{V}(I)$  for the ideal in Example 2?

In any case, we can use Proposition 1 in the following way to describe a portion of the algebraic structure of the quotient ring  $k[x_1, \dots, x_n]/I$ .

**Proposition 4.** *Let  $I \subset k[x_1, \dots, x_n]$  be an ideal. Then  $k[x_1, \dots, x_n]/I$  is isomorphic as a  $k$ -vector space to  $S = \text{Span}(x^\alpha : x^\alpha \notin \langle LT(I) \rangle)$ .*

**Proof.** By Proposition 1, the mapping  $\Phi : k[x_1, \dots, x_n]/I \rightarrow S$  defined by  $\Phi([f]) = \overline{f}^G$  defines a one-to-one correspondence between the classes in  $k[x_1, \dots, x_n]/I$  and the elements of  $S$ . Hence, it remains to check that  $\Phi$  preserves the vector space operations. Consider the sum operation in  $k[x_1, \dots, x_n]/I$  introduced in §2. If  $[f], [g]$  are elements of  $k[x_1, \dots, x_n]/I$ , then using Proposition 1, we can “standardize” our polynomial representatives by computing remainders with respect to a Groebner basis  $G$  for  $I$ . By Exercise 12 of Chapter 2, §6, we have  $\overline{f + g}^G = \overline{f}^G + \overline{g}^G$ , so that if

$$\overline{f}^G = \sum_{\alpha} c_{\alpha} x^{\alpha} \quad \text{and} \quad \overline{g}^G = \sum_{\alpha} d_{\alpha} x^{\alpha}$$

(where the sum is over those  $\alpha$  with  $x^\alpha \notin \langle \text{LT}(I) \rangle$ ), then

$$(1) \quad \overline{f + g}^G = \sum_{\alpha} (c_{\alpha} + d_{\alpha})x^{\alpha}.$$

We conclude that with the standard representatives, the sum operation in  $k[x_1, \dots, x_n]/I$  is the same as the vector sum in the  $k$ -vector space  $S = \text{Span}(x^{\alpha} : x^{\alpha} \notin \langle \text{LT}(I) \rangle)$ . Further, if  $c \in k$ , we leave it as an exercise to prove that  $\overline{c \cdot f}^G = c \cdot \overline{f}^G$  (this is an easy consequence of the uniqueness part of Proposition 1). It follows that

$$\overline{c \cdot f}^G = \sum_{\alpha} cc_{\alpha}x^{\alpha},$$

which shows that multiplication by  $c$  in  $k[x_1, \dots, x_n]/I$  is the same as scalar multiplication in  $S$ . This shows that the map  $\Phi$  is linear and hence is a vector space isomorphism.  $\square$

The product operation in  $k[x_1, \dots, x_n]/I$  is slightly less straightforward. The reason for this is clear, however, if we consider an example. Let  $I$  be the ideal

$$I = \langle y + x^2 - 1, xy - 2y^2 + 2y \rangle \subset \mathbb{R}[x, y].$$

If we compute a Groebner basis for  $I$  using lex order with  $x > y$ , then we get

$$(2) \quad G = \{x^2 + y - 1, xy - 2y^2 + 2y, y^3 - (7/4)y^2 + (3/4)y\}.$$

Thus,  $\langle \text{LT}(I) \rangle = \langle x^2, xy, y^3 \rangle$ , and  $\{1, x, y, y^2\}$  forms a basis for the vector space of remainders modulo  $I$ . Consider the classes of  $f = 3y^2 + x$  and  $g = x - y$  in  $\mathbb{R}[x, y]/I$ . The product of  $[f]$  and  $[g]$  is represented by  $f \cdot g = 3xy^2 + x^2 - 3y^3 - xy$ . However, this polynomial cannot be the standard representative of the product function because it contains monomials that are in  $\langle \text{LT}(I) \rangle$ . Hence, we should *divide* again by  $G$ , and the remainder  $\overline{f \cdot g}^G$  will be the standard representative of the product. We have

$$\overline{3xy^2 + x^2 - 3y^3 - xy}^G = (-11/4)y^2 - (5/4)y + 1,$$

which is in  $\text{Span}(1, x, y, y^2)$  as we expect.

The above discussion gives a completely algorithmic way to handle computations in  $k[x_1, \dots, x_n]/I$ . To summarize, we have proved the following result.

**Proposition 5.** *Let  $I$  be an ideal in  $k[x_1, \dots, x_n]$  and let  $G$  be a Groebner basis for  $I$  with respect to any monomial order. For each  $[f] \in k[x_1, \dots, x_n]/I$ , we get the standard representative  $\overline{f} = \overline{f}^G$  in  $S = \text{Span}(x^{\alpha} : x^{\alpha} \notin \langle \text{LT}(I) \rangle)$ . Then:*

- (i)  $[f] + [g]$  is represented by  $\overline{f} + \overline{g}$ .
- (ii)  $[f] \cdot [g]$  is represented by  $\overline{f \cdot g}^G \in S$ .

We will conclude this section by using the ideas we have developed to give an algorithmic criterion to determine when a variety in  $\mathbb{C}^n$  contains only a finite number of points or, equivalently, to determine when a system of polynomial equations has only a finite number of solutions in  $\mathbb{C}^n$ . (As in Chapter 3, we must work over an algebraically

closed field to ensure that we are not “missing” any solutions of the equations with coordinates in a larger field  $K \supset k$ .)

**Theorem 6.** *Let  $V = \mathbf{V}(I)$  be an affine variety in  $\mathbb{C}^n$  and fix a monomial ordering in  $\mathbb{C}[x_1, \dots, x_n]$ . Then the following statements are equivalent:*

- (i)  $V$  is a finite set.
- (ii) For each  $i$ ,  $1 \leq i \leq n$ , there is some  $m_i \geq 0$  such that  $x_i^{m_i} \in \langle \text{LT}(I) \rangle$ .
- (iii) Let  $G$  be a Groebner basis for  $I$ . Then for each  $i$ ,  $1 \leq i \leq n$ , there is some  $m_i \geq 0$  such that  $x_i^{m_i} = \text{LM}(g_i)$  for some  $g_i \in G$ .
- (iv) The  $\mathbb{C}$ -vector space  $S = \text{span}(x^\alpha : x^\alpha \notin \langle \text{LT}(I) \rangle)$  is finite-dimensional.
- (v) The  $\mathbb{C}$ -vector space  $\mathbb{C}[x_1, \dots, x_n]/I$  is finite-dimensional.

**Proof.** (i)  $\Rightarrow$  (ii) If  $V = \emptyset$ , then  $1 \in I$  by the Weak Nullstellensatz. In this case, we can take  $m_i = 0$  for all  $i$ . If  $V$  is nonempty, then for a fixed  $i$ , let  $a_j$ ,  $j = 1, \dots, k$ , be the distinct complex numbers appearing as  $i$ -th coordinates of points in  $V$ . Form the one-variable polynomial

$$f(x_i) = \prod_{j=1}^k (x_i - a_j).$$

By construction,  $f$  vanishes at every point in  $V$ , so  $f \in \mathbf{I}(V)$ . By the Nullstellensatz, there is some  $m \geq 1$  such that  $f^m \in I$ . But this says that the leading monomial of  $f^m$  is in  $\langle \text{LT}(I) \rangle$ . Examining our expression for  $f$ , we see that  $x_i^{km} \in \langle \text{LT}(I) \rangle$ .

(ii)  $\Leftrightarrow$  (iii)  $x_i^{m_i} \in \langle \text{LT}(I) \rangle$ . Since  $G$  is a Groebner basis of  $I$ ,  $\langle \text{LT}(I) \rangle = \langle \text{LT}(g) \rangle : g \in G$ . By Lemma 2 of Chapter 2, §4, there is some  $g_i \in G$ , such that  $\text{LT}(g_i)$  divides  $x_i^{m_i}$ . But this implies that  $\text{LT}(g_i)$  is a power of  $x_i$ , as claimed. The opposite implication follows directly from the definition of  $\langle \text{LT}(g) \rangle$ .

(ii)  $\Rightarrow$  (iv) If some power  $x_i^{m_i} \in \langle \text{LT}(I) \rangle$  for each  $i$ , then the monomials  $x_1^{\alpha_1} \dots x_n^{\alpha_n}$  for which some  $\alpha_i \geq m_i$  are all in  $\langle \text{LT}(I) \rangle$ . The monomials in the complement of  $\langle \text{LT}(I) \rangle$  must have  $\alpha_i \leq m_i - 1$  for each  $i$ . As a result, the number of monomials in the complement of  $\langle \text{LT}(I) \rangle$  can be at most  $m_1 \cdot m_2 \cdot \dots \cdot m_n$ .

(iv)  $\Leftrightarrow$  (v) follows from Proposition 4.

(v)  $\Rightarrow$  (i) To show that  $V$  is finite, it suffices to show that for each  $i$  there can be only finitely many distinct  $i$ -th coordinates for the points of  $V$ . Fix  $i$  and consider the classes  $[x_i^j]$  in  $\mathbb{C}[x_1, \dots, x_n]/I$ , where  $j = 0, 1, 2, \dots$ . Since  $\mathbb{C}[x_1, \dots, x_n]/I$  is finite-dimensional, the  $[x_i^j]$  must be linearly dependent in  $\mathbb{C}[x_1, \dots, x_n]/I$ . That is, there exist constants  $c_j$  (not all zero) and some  $m$  such that

$$\sum_{j=0}^m c_j [x_i^j] = \left[ \sum_{j=0}^m c_j x_i^j \right] = [0].$$

However, this implies that  $\sum_{j=0}^m c_j x_i^j \in I$ . Since a nonzero polynomial can have only finitely many roots in  $\mathbb{C}$ , this shows that the points of  $V$  have only finitely many different  $i$ -th coordinates.

We note that the hypothesis  $k = \mathbb{C}$  was used only in showing that (i)  $\Rightarrow$  (ii). The other implications are true even if  $k$  is not algebraically closed.  $\square$

A judicious choice of monomial ordering can sometimes lead to a very easy determination that a variety is finite. For example, consider the ideal

$$I = \langle x^5 + y^3 + z^2 - 1, x^2 + y^3 + z - 1, x^4 + y^5 + z^6 - 1 \rangle.$$

Using `grlex`, we see that  $x^5, y^3, z^6 \in \langle \text{LT}(I) \rangle$  since these are the leading monomials of the three generators. By part (ii) of the theorem, we know that  $\mathbf{V}(I)$  is finite (even without computing a Groebner basis). If we actually wanted to determine which points were in  $\mathbf{V}(I)$ , we would need to do elimination, for instance, by computing a lexicographic Groebner basis. This can be a time-consuming calculation, even for a computer algebra system.

The criterion given in part (ii) of Theorem 6 also leads to the following quantitative estimate of the number of solutions of a system of equations when that number is finite.

**Proposition 7.** *Let  $I \subset \mathbb{C}[x_1, \dots, x_n]$  be an ideal such that for each  $i$ , some power  $x_i^{m_i} \in \langle \text{LT}(I) \rangle$ . Then the number of points of  $\mathbf{V}(I)$  is at most  $m_1 \cdot m_2 \cdots m_n$ .*

**Proof.** This is an easy consequence of Proposition 8 below. See Exercise 8.  $\square$

Here is a pair of examples to illustrate the proposition. First consider the variety  $V = \mathbf{V}(I)$ , where  $I = \langle y - x^7, x^{12} - x \rangle$ . For  $y > x$ , the lexicographic Groebner basis for this ideal is  $G = \{y - x^7, x^{12} - x\}$ . Hence, in the notation of the theorem, we have  $m_1 = 12$  and  $m_2 = 1$  as the smallest powers of the two variables contained in  $\langle \text{LT}(I) \rangle$ . By solving the equations from  $G$ , we see that  $V$  actually contains  $12 = m_1 \cdot m_2$  points in this case:

$$V = \{(0, 0)\} \cup \{(\zeta, \zeta^7) : \zeta^{11} = 1\}.$$

(Recall that there are 11 distinct 11th roots of unity in  $\mathbb{C}$ .)

On the other hand, consider the variety  $V = \mathbf{V}(x^2 + y - 1, xy - 2y^2 + 2y)$  in  $\mathbb{C}^2$ . From the lexicographic Groebner basis computed in (2) for this ideal, we see that  $m_1 = 2$  and  $m_2 = 3$  are the smallest powers of  $x$  and  $y$ , respectively, contained in  $\langle \text{LT}(I) \rangle$ . However,  $V$  contains only  $4 < 2 \cdot 3$  points in  $\mathbb{C}^2$ :

$$V = \{(\pm 1, 0), (0, 1), (-1/2, 3/4)\}.$$

Can you explain the reason(s) for the difference between  $m_1 \cdot m_2$  and the cardinality of  $V$  in this example?

We can improve the bound given in Proposition 7 as follows.

**Proposition 8.** *Let  $I \subset \mathbb{C}[x_1, \dots, x_n]$  be an ideal such that  $V = \mathbf{V}(I)$  is a finite set.*

- (i) *The number of points in  $V$  is at most  $\dim(\mathbb{C}[x_1, \dots, x_n]/I)$  (where “dim” means dimension as a vector space over  $\mathbb{C}$ ).*
- (ii) *If  $I$  is a radical ideal, then equality holds, i.e., the number of points in  $V$  is exactly  $\dim(\mathbb{C}[x_1, \dots, x_n]/I)$ .*

**Proof.** We first show that given distinct points  $p_1, \dots, p_m \in \mathbb{C}^n$ , there is a polynomial  $f_1 \in \mathbb{C}[x_1, \dots, x_n]$  with  $f_1(p_1) = 1$  and  $f_1(p_2) = \dots = f_1(p_m) = 0$ . To prove this, note that if  $a \neq b \in \mathbb{C}^n$ , then they must differ at some coordinate, say the  $j$ -th, and it follows that  $g = (x_j - b_j)/(a_j - b_j)$  satisfies  $g(a) = 1, g(b) = 0$ . If we apply this observation to each pair  $p_1 \neq p_i, i \geq 2$ , we get polynomials  $g_i$  such that  $g_i(p_1) = 1$  and  $g_i(p_i) = 0$  for  $i \geq 2$ . Then  $f_1 = g_2 \cdot g_3 \cdots g_m$  has the desired property.

In the argument just given, there is nothing special about  $p_1$ . If we apply the same argument with  $p_1$  replaced by each of  $p_1, \dots, p_m$  in turn, we get polynomials  $f_1, \dots, f_m$  such that  $f_i(p_i) = 1$  and  $f_i(p_j) = 0$  for  $i \neq j$ .

Now we can prove the proposition. Suppose that  $V = \{p_1, \dots, p_m\}$ , where the  $p_i$  are distinct. Then we get  $f_1, \dots, f_m$  as above. If we can prove that  $[f_1], \dots, [f_m] \in \mathbb{C}[x_1, \dots, x_n]/I$  are linearly independent, then

$$(3) \qquad m \leq \dim(\mathbb{C}[x_1, \dots, x_n]/I)$$

will follow, and the first part of the proposition will be proved.

To prove linear independence, suppose that  $\sum_{i=1}^m a_i [f_i] = [0]$  in  $\mathbb{C}[x_1, \dots, x_n]/I$ , where  $a_i \in \mathbb{C}$ . Back in  $\mathbb{C}[x_1, \dots, x_n]$ , this means that  $g = \sum_{i=1}^m a_i f_i \in I$ , so that  $g$  vanishes at all points of  $V = \{p_1, \dots, p_m\}$ . Then, for  $1 \leq j \leq m$ , we have

$$0 = g(p_j) = \sum_{i=1}^m a_i f_i(p_j) = 0 + a_j f_j(p_j) = a_j,$$

and linear independence follows.

Finally, suppose that  $I$  is radical. To prove that equality holds in (3), it suffices to show that  $[f_1], \dots, [f_m]$  form a basis of  $\mathbb{C}[x_1, \dots, x_n]/I$ . Since we just proved linear independence, we only need to show that they span. Thus, let  $[g] \in \mathbb{C}[x_1, \dots, x_n]/I$  be arbitrary, and set  $a_i = g(p_i)$ . Then consider  $h = g - \sum_{i=1}^m a_i f_i$ . One easily computes  $h(p_j) = 0$  for all  $j$ , so that  $h \in \mathbf{I}(V)$ . By the Nullstellensatz,  $\mathbf{I}(V) = \mathbf{I}(\mathbf{V}(I)) = \sqrt{I}$  since  $\mathbb{C}$  is algebraically closed, and since  $I$  is radical, we conclude that  $h \in I$ . Thus  $[h] = [0]$  in  $\mathbb{C}[x_1, \dots, x_n]/I$ , which implies  $[g] = \sum_{i=1}^m a_i [f_i]$ . The proposition is now proved. □

To see why this proposition represents an improvement over Proposition 7, consider Example 2 from the beginning of this section. Using grlex, we found  $x^4, y^4 \in \langle LT(I) \rangle$ , so the  $\mathbf{V}(I)$  has  $\leq 4 \cdot 4 = 16$  points by Proposition 7. Yet Example 2 also shows that  $\mathbb{C}[x, y]/I$  has dimension 12 over  $\mathbb{C}$ . Thus Proposition 8 gives a better bound of 12.

For any ideal  $I$ , we have  $\mathbf{V}(I) = \mathbf{V}(\sqrt{I})$ . Thus, when  $\mathbf{V}(I)$  is finite, Proposition 8 shows how to find the exact number of solutions over  $\mathbb{C}$ , provided we know  $\sqrt{I}$ . Although radicals are hard to compute in general,  $\sqrt{I}$  is relatively easy to find when  $I$  satisfies the conditions of Theorem 6. For a description of the algorithm, see Theorem 8.20 of BECKER and WEISPFENNING (1993). This subject (and its relation to solving equations) is also discussed in COX, LITTLE and O'SHEA (1998).

Theorem 6 shows how we can characterize “zero-dimensional” varieties (varieties containing only finitely many points) using the properties of  $\mathbb{C}[x_1, \dots, x_n]/I$ . In

Chapter 9, we will take up the general question of assigning a *dimension* to a general variety, and some of the ideas introduced here will be useful.

**EXERCISES FOR §3**

1. Complete the proof of part (ii) of Proposition 1.
2. In Proposition 5, we stated a method for computing  $[f] \cdot [g]$  in  $k[x_1, \dots, x_n]/I$ . Could we simply compute  $\overline{f \cdot g}^G$  rather than first computing the remainders of  $f$  and  $g$  separately?
3. Let  $I = \langle x^4y - z^6, x^2 - y^3z, x^3z^2 - y^3 \rangle$  in  $k[x, y, z]$ .
  - a. Using lex order, find a Groebner basis  $G$  for  $I$  and a collection of monomials that spans the space of remainders modulo  $G$ .
  - b. Repeat part (a) for grlex order. How do your sets of monomials compare?
4. Use the division algorithm and the uniqueness part of Proposition 1 to prove that  $\overline{c \cdot f}^G = c \cdot \overline{f}^G$  whenever  $f \in [x_1, \dots, x_n]$  and  $c \in k$ .
5. Let  $I = \langle y + x^2 - 1, xy - 2y^2 + 2y \rangle \subset \mathbb{R}[x, y]$ . (This is the ideal used in the example following Proposition 4.)
  - a. Construct a vector space isomorphism  $\mathbb{R}[x, y]/I \cong \mathbb{R}^4$ .
  - b. Using the lexicographic Groebner basis given in (2), compute a “multiplication table” for the elements  $\{[1], [x], [y], [y^2]\}$  in  $\mathbb{R}[x, y]/I$ . (Express each product as a linear combination of these four classes.)
  - c. Is  $\mathbb{R}[x, y]/I$  a field? Why or why not?
6. Let  $V = \mathbf{V}(x_3 - x_1^2, x_4 - x_1x_2, x_2x_4 - x_1x_5, x_4^2 - x_3x_5) \subset \mathbb{C}^5$ .
  - a. Using any convenient monomial order, determine a collection of monomials spanning the space of remainders modulo a Groebner basis for the ideal generated by the defining equations of  $V$ .
  - b. For which  $i$  is there some  $m_i \geq 0$  such that  $x_i^{m_i} \in \langle \text{LT}(I) \rangle$ ?
  - c. Is  $V$  a finite set? Why or why not?
7. Let  $I$  be any ideal in  $k[x_1, \dots, x_n]$ .
  - a. Suppose that  $S = \text{Span}(x^\alpha : x^\alpha \notin \langle \text{LT}(I) \rangle)$  is a  $k$ -vector space of finite dimension  $d$  for some choice of monomial order. Show that the dimension of  $k[x_1, \dots, x_n]/I$  as a  $k$ -vector space is equal to  $d$ .
  - b. Deduce from part (a) that the number of monomials in the complement of  $\langle \text{LT}(I) \rangle$  is independent of the choice of the monomial order, when that number is finite.
8. Prove Proposition 7 using Propositions 4 and 8 and the proof of (ii)  $\Rightarrow$  (iv) of Theorem 6.
9. Suppose that  $I \subset \mathbb{C}[x_1, \dots, x_n]$  is a radical ideal with a Groebner basis  $f_1, \dots, f_n$  such that  $\text{LT}(f_i) = x_i^{m_i}$  for each  $i$ . Prove that  $\mathbf{V}(I)$  contains *exactly*  $m_1 \cdot m_2 \cdots m_n$  points.
10. Most computer algebra systems contain routines for simplifying radical expressions. For example, instead of writing

$$r = \frac{1}{x + \sqrt{2} + \sqrt{3}},$$

most systems would allow you to rationalize the denominator and rewrite  $r$  as a quotient of polynomials in  $x$ , where  $\sqrt{2}$  and  $\sqrt{3}$  appear in the coefficients only in the numerator. The idea behind one method used here is as follows.

- a. Explain why  $r$  can be seen as a rational function in  $x$ , whose coefficients are elements of the quotient ring  $R = \mathbb{Q}[y_1, y_2]/\langle y_1^2 - 2, y_2^2 - 3 \rangle$ . Hint: See Exercise 4 from §2 of this chapter.

- b. Compute a Groebner basis  $G$  for  $I = \langle y_1^2 - 2, y_2^2 - 3 \rangle$  and construct a multiplication table for the classes of the monomials spanning the possible remainders modulo  $G$  (which should be  $\{[1], [y_1], [y_2], [y_1 y_2]\}$ ).
- c. Now, to rationalize the denominator of  $r$ , we can try to solve the following equation

$$(4) \quad (x[1] + [y_1] + [y_2]) \cdot (a_0[1] + a_1[y_1] + a_2[y_2] + a_3[y_1 y_2]) = [1],$$

where  $a_0, a_1, a_2, a_3$  are rational functions of  $x$  with rational number coefficients. Multiply out (4) using your table from part (b), match coefficients, and solve the resulting linear equations for  $a_0, a_1, a_2, a_3$ . Then

$$a_0[1] + a_1[y_1] + a_2[y_2] + a_3[y_1 y_2]$$

gives the rationalized expression for  $r$ .

- 11. In this problem, we will establish a fact about the number of monomials of total degree less than or equal to  $d$  in  $k[x_1, \dots, x_n]$  and relate this to the intuitive notion of the dimension of the variety  $V = k^n$ .
  - a. Explain why every monomial in  $k[x_1, \dots, x_n]$  is in the complement of  $\langle \text{LT}(I(V)) \rangle$  for  $V = k^n$ .
  - b. Show that for all  $d, n \geq 0$ , the number of distinct monomials of degree less than or equal to  $d$  in  $k[x_1, \dots, x_n]$  is the binomial coefficient  $\binom{n+d}{n}$ . (This generalizes part (a) of Exercise 5 in Chapter 2, §1.)
  - c. When  $n$  is fixed, explain why this number of monomials grows like  $d^n$  as  $d \rightarrow \infty$ . Note that the *exponent*  $n$  is the same as the intuitive dimension of the variety  $V = k^n$ , for which  $k[V] = k[x_1, \dots, x_n]$ .
- 12. In this problem, we will compare what happens with the monomials not in  $\langle \text{LT}(I) \rangle$  in two examples where  $\mathbf{V}(I)$  is not finite, and one where  $\mathbf{V}(I)$  is finite.
  - a. Consider the variety  $\mathbf{V}(I) \subset \mathbb{C}^3$ , where  $I = \langle x^2 + y, x - y^2 + z^2, xy - z \rangle$ . Compute a Groebner basis for  $I$  using lex order, and, for  $1 \leq d \leq 10$ , tabulate the number of monomials of degree  $\leq d$  that are not in  $\langle \text{LT}(I) \rangle$ . Note that by Theorem 6,  $\mathbf{V}(I)$  is a finite subset of  $\mathbb{C}^3$ . Hint: It may be helpful to try to visualize or sketch a 3-dimensional analogue of the diagrams in Example 2 for this ideal.
  - b. Repeat the calculations of part a for  $J = \langle x^2 + y, x - y^2 + z^2 \rangle$ . Here,  $\mathbf{V}(J)$  is not finite. How does the behavior of the number of monomials of degree  $\leq d$  in the complement of  $\langle \text{LT}(J) \rangle$  (as a function of  $d$ ) differ from the behavior in part (a)?
  - c. Let  $H_J(d)$  be the number of monomials of degree  $\leq d$  in the complement of  $\langle \text{LT}(J) \rangle$ . Can you guess a power  $k$  such that  $H_J(d)$  will grow roughly like  $d^k$  as  $d$  grows?
  - d. Now repeat parts (b) and (c) for the ideal  $K = \langle x^2 + y \rangle$ .
  - e. Using the intuitive notion of the dimension of a variety that we developed in Chapter 1, can you see a pattern here? We will return to these questions in Chapter 9.
- 13. Let  $k$  be any field, and suppose  $I \subset k[x_1, \dots, x_n]$  has the property that  $k[x_1, \dots, x_n]/I$  is a finite-dimensional vector space over  $k$ .
  - a. Prove that  $\dim(k[x_1, \dots, x_n]/\sqrt{I}) \leq \dim(k[x_1, \dots, x_n]/I)$ . Hint: Show that  $I \subset \sqrt{I}$  induces a map of quotient rings  $k[x_1, \dots, x_n]/I \rightarrow k[x_1, \dots, x_n]/\sqrt{I}$  which is onto.
  - b. Show that the number of points in  $\mathbf{V}(I)$  is at most  $\dim(k[x_1, \dots, x_n]/\sqrt{I})$ .
  - c. Give an example to show that equality need not hold in part (b) when  $k$  is not algebraically closed.

## §4 The Coordinate Ring of an Affine Variety

In this section, we will apply the algebraic tools developed in §§2 and 3 to study the ring  $k[V]$  of polynomial functions on an affine variety  $V \subset k^n$ . Using the isomorphism  $k[V] \cong k[x_1, \dots, x_n]/\mathbf{I}(V)$  from §2, we will frequently identify  $k[V]$  with the quotient ring  $k[x_1, \dots, x_n]/\mathbf{I}(V)$ . Thus, given a polynomial  $f \in k[x_1, \dots, x_n]$ , we let  $[f]$  denote the polynomial function in  $k[V]$  represented by  $f$ .

In particular, each variable  $x_i$  gives a polynomial function  $[x_i] : V \rightarrow k$  whose value at a point  $p \in V$  is the  $i$ -th coordinate of  $p$ . We call  $[x_i] \in k[V]$  the  $i$ -th *coordinate function* on  $V$ . Then the isomorphism  $k[V] \cong k[x_1, \dots, x_n]/\mathbf{I}(V)$  shows that the coordinate functions generate  $k[V]$  in the sense that any polynomial function on  $V$  is a  $k$ -linear combination of products of the  $[x_i]$ . This explains the following terminology.

**Definition 1.** *The coordinate ring of an affine variety  $V \subset k^n$  is the ring  $k[V]$ .*

Many results from previous sections of this chapter can be rephrased in terms of the coordinate ring. For example:

- Proposition 4 from §1: A variety is irreducible if and only if its coordinate ring is an integral domain.
- Theorem 6 from §3: Over  $k = \mathbb{C}$ , a variety is finite if and only if its coordinate ring is finite-dimensional as a  $\mathbb{C}$ -vector space.

In the “algebra–geometry” dictionary of Chapter 4, we related varieties in  $k^n$  to ideals in  $k[x_1, \dots, x_n]$ . One theme of Chapter 5 is that this dictionary still works if we replace  $k^n$  and  $k[x_1, \dots, x_n]$  by a general variety  $V$  and its coordinate ring  $k[V]$ . For this purpose, we introduce the following definitions.

**Definition 2.** *Let  $V \subset k^n$  be an affine variety.*

- (i) *For any ideal  $J = \langle \phi_1, \dots, \phi_s \rangle \subset k[V]$ , we define*

$$\mathbf{V}_V(J) = \{(a_1, \dots, a_n) \in V : \phi(a_1, \dots, a_n) = 0 \text{ for all } \phi \in J\}.$$

*We call  $\mathbf{V}_V(J)$  a **subvariety** of  $V$ .*

- (ii) *For each subset  $W \subset V$ , we define*

$$\mathbf{I}_V(W) = \{\phi \in k[V] : \phi(a_1, \dots, a_n) = 0 \text{ for all } (a_1, \dots, a_n) \in W\}.$$

For instance, let  $V = \mathbf{V}(z - x^2 - y^2) \subset \mathbb{R}^3$ . If we take  $J = \langle [x] \rangle \subset \mathbb{R}[V]$ , then

$$W = \mathbf{V}_V(J) = \{(0, y, y^2) : y \in \mathbb{R}\} \subset V$$

is a subvariety of  $V$ . Note that this is the same as  $\mathbf{V}(z - x^2 - y^2, x)$  in  $\mathbb{R}^3$ . Similarly, if we let  $W = \{(1, 1, 2)\} \subset V$ , then we leave it as an exercise to show that

$$\mathbf{I}_V(W) = \langle [x - 1], [y - 1] \rangle.$$

Given a fixed affine variety  $V$ , we can use  $\mathbf{I}_V$  and  $\mathbf{V}_V$  to relate subvarieties of  $V$  to ideals in  $k[V]$ . The first result we get is the following.



**Proposition 3.** *Let  $V \subset k^n$  be an affine variety.*

- (i) *For each ideal  $J \subset k[V]$ ,  $W = \mathbf{V}_V(J)$  is an affine variety in  $k^n$  contained in  $V$ .*
- (ii) *For each subset  $W \subset V$ ,  $\mathbf{I}_V(W)$  is an ideal of  $k[V]$ .*
- (iii) *If  $J \subset k[V]$  is an ideal, then  $J \subset \sqrt{J} \subset \mathbf{I}_V(\mathbf{V}_V(J))$ .*
- (iv) *If  $W \subset V$  is a subvariety, then  $W = \mathbf{V}_V(\mathbf{I}_V(W))$ .*

**Proof.** To prove (i), we will use the one-to-one correspondence of Proposition 10 of §2 between the ideals of  $k[V]$  and the ideals in  $k[x_1, \dots, x_n]$  containing  $\mathbf{I}(V)$ . Let  $\tilde{J} = \{f \in k[x_1, \dots, x_n] : [f] \in J\} \subset k[x_1, \dots, x_n]$  be the ideal corresponding to  $J \subset k[V]$ . Then  $\mathbf{V}(\tilde{J}) \subset V$ , since  $\mathbf{I}(V) \subset \tilde{J}$ . But we also have  $\mathbf{V}(\tilde{J}) = \mathbf{V}_V(J)$  by definition since the elements of  $\tilde{J}$  represent the functions in  $J$  on  $V$ . Thus,  $W$  (considered as a subset of  $k^n$ ) is an affine variety in its own right.

The proofs of (ii), (iii), and (iv) are similar to arguments given in earlier chapters and the details are left as an exercise. Note that the definition of the radical of an ideal is the same in  $k[V]$  as it is in  $k[x_1, \dots, x_n]$ . □

We can also show that the radical ideals in  $k[V]$  correspond to the radical ideals in  $k[x_1, \dots, x_n]$  containing  $\mathbf{I}(V)$ .

**Proposition 4.** *An ideal  $J \subset k[V]$  is radical if and only if the corresponding ideal  $\tilde{J} = \{f \in k[x_1, \dots, x_n] : [f] \in J\} \subset k[x_1, \dots, x_n]$  is radical.*

**Proof.** Assume  $J$  is radical, and let  $f \in k[x_1, \dots, x_n]$  satisfy  $f^m \in \tilde{J}$  for some  $m \geq 1$ . Then  $[f^m] = [f]^m \in J$ . Since  $J$  is a radical ideal, this implies that  $[f] \in J$ . Hence,  $f \in J$ , so  $\tilde{J}$  is also a radical ideal. Conversely, if  $\tilde{J}$  is radical and  $[f]^m \in J$ , then  $[f^m] \in J$ , so  $f^m \in \tilde{J}$ . Since  $\tilde{J}$  is radical, this shows that  $f \in \tilde{J}$ . Hence,  $[f] \in J$  and  $J$  is radical. □

Rather than discuss the complete “ideal–variety” correspondence (as we did in Chapter 4), we will confine ourselves to the following result which highlights some of the important properties of the correspondence.

**Theorem 5.** *Let  $k$  be an algebraically closed field and let  $V \subset k^n$  be an affine variety.*

- (i) **(The Nullstellensatz in  $k[V]$ )** *If  $J$  is any ideal in  $k[V]$ , then*

$$\mathbf{I}_V(\mathbf{V}_V(J)) = \sqrt{J} = \{[f] \in k[V] : [f]^m \in J\}.$$

- (ii) *The correspondences*

$$\left\{ \begin{array}{l} \text{affine subvarieties} \\ W \subset V \end{array} \right\} \begin{array}{c} \xrightarrow{\mathbf{I}_V} \\ \xleftarrow{\mathbf{V}_V} \end{array} \left\{ \begin{array}{l} \text{radical ideals} \\ J \subset k[V] \end{array} \right\}$$

*are inclusion-reversing bijections and are inverses of each other.*

- (iii) *Under the correspondence given in (ii), points of  $V$  correspond to maximal ideals of  $k[V]$ .*

**Proof.** (i) Let  $J$  be an ideal of  $k[V]$ . By the correspondence of Proposition 10 of §2,  $J$  corresponds to the ideal  $\tilde{J} \subset k[x_1, \dots, x_n]$  as in the proof of Proposition 4, where  $\mathbf{V}(\tilde{J}) = \mathbf{V}_V(J)$ . As a result, if  $[f] \in \mathbf{I}_V(\mathbf{V}_V(J))$ , then  $f \in \mathbf{I}(\mathbf{V}(\tilde{J}))$ . By the Nullstellensatz in  $k^n$ ,  $\mathbf{I}(\mathbf{V}(\tilde{J})) = \sqrt{\tilde{J}}$ , so  $f^m \in \tilde{J}$  for some  $m \geq 1$ . But then,  $[f^m] = [f]^m \in J$ , so  $[f] \in \sqrt{J}$  in  $k[V]$ . We have shown that  $\mathbf{I}_V(\mathbf{V}_V(J)) \subset \sqrt{J}$ . Since the opposite inclusion holds for any ideal, our Nullstellensatz in  $k[V]$  is proved.

(ii) follows from (i) as in Chapter 4.

(iii) is proved in the same way as Theorem 11 of Chapter 4, §5. □

Next, we return to the general topic of a *classification* of varieties that we posed in §1. What should it mean for two affine varieties to be “isomorphic”? One reasonable answer is given in the following definition.

**Definition 6.** Let  $V \subset k^m$  and  $W \subset k^n$  be affine varieties. We say that  $V$  and  $W$  are **isomorphic** if there exist polynomial mappings  $\alpha : V \rightarrow W$  and  $\beta : W \rightarrow V$  such that  $\alpha \circ \beta = \text{id}_W$  and  $\beta \circ \alpha = \text{id}_V$ . (For any variety  $V$ , we write  $\text{id}_V$  for the identity mapping from  $V$  to itself. This is always a polynomial mapping.)

Intuitively, varieties that *are* isomorphic should share properties such as irreducibility, dimension, etc. In addition, subvarieties of  $V$  should correspond to subvarieties of  $W$ , and so forth. For instance, saying that a variety  $W \subset k^n$  is isomorphic to  $V = k^m$  implies that there is a one-to-one and onto polynomial mapping  $\alpha : k^m \rightarrow W$  with a polynomial inverse. Thus, we have a polynomial *parametrization* of  $W$  with especially nice properties! Here is an example, inspired by a technique used in geometric modeling, which illustrates the usefulness of this idea.

**Example 7.** Let us consider the two surfaces

$$\begin{aligned} Q_1 &= \mathbf{V}(x^2 - xy - y^2 + z^2) = \mathbf{V}(f_1), \\ Q_2 &= \mathbf{V}(x^2 - y^2 + z^2 - z) = \mathbf{V}(f_2) \end{aligned}$$

in  $\mathbb{R}^3$ . (These might be boundary surfaces of a solid region in a shape we were designing, for example.) To study the *intersection curve*  $C = \mathbf{V}(f_1, f_2)$  of the two surfaces, we could proceed as follows. Neither  $Q_1$  nor  $Q_2$  is an especially simple surface, so the intersection curve is fairly difficult to visualize directly. However, as usual, we are *not limited* to using the particular equations  $f_1, f_2$  to define the curve! It is easy to check that  $C = \mathbf{V}(f_1, f_1 + cf_2)$ , where  $c \in \mathbb{R}$  is any nonzero real number. Hence, the surfaces  $F_c = \mathbf{V}(f_1 + cf_2)$  also contain  $C$ . These surfaces, together with  $Q_2$ , are often called the elements of the *pencil* of surfaces determined by  $Q_1$  and  $Q_2$ . (A pencil of varieties is a one-parameter family of varieties, parametrized by the points of  $k$ . In the above case, the parameter is  $c \in \mathbb{R}$ .)

If we can find a value of  $c$  making the surface  $F_c$  particularly simple, then understanding the curve  $C$  will be correspondingly easier. Here, if we take  $c = -1$ , then  $F_{-1}$  is defined by

$$\begin{aligned} 0 &= f_1 - f_2 \\ &= z - xy. \end{aligned}$$

The surface  $Q = F_{-1} = \mathbf{V}(z - xy)$  is much easier to understand because it is *isomorphic as a variety* to  $\mathbb{R}^2$  [as is the graph of any polynomial function  $f(x, y)$ ]. To see this, note that we have polynomial mappings:

$$\begin{aligned}\alpha : \mathbb{R}^2 &\longrightarrow Q, \\ (x, y) &\mapsto (x, y, xy), \\ \pi : Q &\longrightarrow \mathbb{R}^2, \\ (x, y, z) &\mapsto (x, y),\end{aligned}$$

which satisfy  $\alpha \circ \pi = \text{id}_Q$  and  $\pi \circ \alpha = \text{id}_{\mathbb{R}^2}$ .

Hence, curves on  $Q$  can be reduced to plane curves in the following way. To study  $C$ , we can project to the curve  $\pi(C) \subset \mathbb{R}^2$ , and we obtain the equation

$$x^2y^2 + x^2 - xy - y^2 = 0$$

for  $\pi(C)$  by substituting  $z = xy$  in either  $f_1$  or  $f_2$ . Note that  $\pi$  and  $\alpha$  restrict to give isomorphisms between  $C$  and  $\pi(C)$ , so we have not really lost anything by projecting in this case.

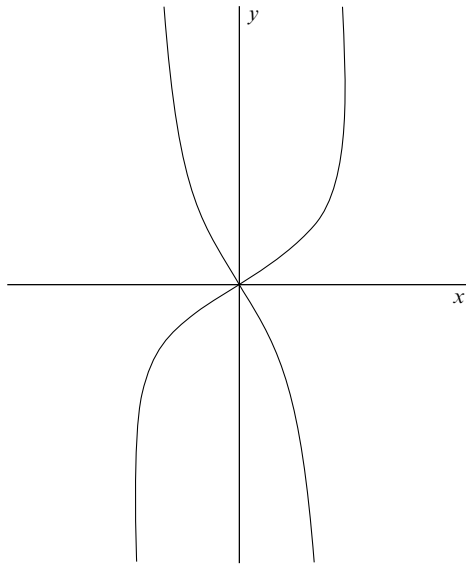

In particular, each point  $(a, b)$  on  $\pi(C)$  corresponds to exactly one point  $(a, b, ab)$  on  $C$ . In the exercises, you will show that  $\pi(C)$  can also be parametrized as

$$(1) \quad \begin{aligned}x &= \frac{-t^2 + t + 1}{t^2 + 1}, \\ y &= \frac{-t^2 + t + 1}{t(t + 2)}.\end{aligned}$$

From this we can also obtain a parametrization of  $C$  via the mapping  $\alpha$ .

Given the above example, it is natural to ask how we can tell whether two varieties are isomorphic. One way is to consider the relation between their coordinate rings

$$k[V] \cong k[x_1, \dots, x_m]/\mathbf{I}(V) \quad \text{and} \quad k[W] \cong k[y_1, \dots, y_n]/\mathbf{I}(W).$$

The fundamental observation is that if we have a polynomial mapping  $\alpha : V \rightarrow W$ , then every polynomial function  $\phi : W \rightarrow k$  in  $k[W]$  gives us another polynomial function  $\phi \circ \alpha : V \rightarrow k$  in  $k[V]$ . This will give us a map from  $k[W]$  to  $k[V]$  with the following properties.

**Proposition 8.** *Let  $V$  and  $W$  be varieties (possibly in different affine spaces).*

- (i) *Let  $\alpha : V \rightarrow W$  be a polynomial mapping. Then for every polynomial function  $\phi : W \rightarrow k$ , the composition  $\phi \circ \alpha : V \rightarrow k$  is also a polynomial function. Furthermore, the map  $\alpha^* : k[W] \rightarrow k[V]$  defined by  $\alpha^*(\phi) = \phi \circ \alpha$  is a ring homomorphism which is the identity on the constant functions  $k \subset k[W]$ . (Note that  $\alpha^*$  “goes in the opposite direction” from  $\alpha$  since  $\alpha^*$  maps functions on  $W$  to functions on  $V$ . For this reason we call  $\alpha^*$  the **pullback mapping** on functions.)*
- (ii) *Conversely, let  $f : k[W] \rightarrow k[V]$  be a ring homomorphism which is the identity on constants. Then there is a unique polynomial mapping  $\alpha : V \rightarrow W$  such that  $f = \alpha^*$ .*

**Proof.** (i) Suppose that  $V \subset k^m$  has coordinates  $x_1, \dots, x_m$  and  $W \subset k^n$  has coordinates  $y_1, \dots, y_n$ . Then  $\phi : W \rightarrow k$  can be represented by a polynomial  $f(y_1, \dots, y_n)$ , and  $\alpha : V \rightarrow W$  can be represented by an  $n$ -tuple of polynomials:

$$\alpha(x_1, \dots, x_m) = (a_1(x_1, \dots, x_m), \dots, a_n(x_1, \dots, x_m)).$$

We compute  $\phi \circ \alpha$  by substituting  $\alpha(x_1, \dots, x_m)$  into  $\phi$ . Thus,

$$(\phi \circ \alpha)(x_1, \dots, x_m) = f(a_1(x_1, \dots, x_m), \dots, a_n(x_1, \dots, x_m)),$$

which is a polynomial in  $x_1, \dots, x_m$ . Hence,  $\phi \circ \alpha$  is a polynomial function on  $V$ .

It follows that we can define  $\alpha^* : k[W] \rightarrow k[V]$  by the formula  $\alpha^*(\phi) = \phi \circ \alpha$ . To show that  $\alpha^*$  is a ring homomorphism, let  $\psi$  be another element of  $k[W]$ , represented by a polynomial  $g(y_1, \dots, y_n)$ . Then

$$\begin{aligned} (\alpha^*(\phi + \psi))(x_1, \dots, x_m) &= f(a_1(x_1, \dots, x_m), \dots, a_n(x_1, \dots, x_m)) \\ &\quad + g(a_1(x_1, \dots, x_m), \dots, a_n(x_1, \dots, x_m)) \\ &= \alpha^*(\phi)(x_1, \dots, x_m) + \alpha^*(\psi)(x_1, \dots, x_m). \end{aligned}$$

Hence,  $\alpha^*(\phi + \psi) = \alpha^*(\phi) + \alpha^*(\psi)$ , and  $\alpha^*(\phi \cdot \psi) = \alpha^*(\phi) \cdot \alpha^*(\psi)$  is proved similarly. Thus,  $\alpha^*$  is a ring homomorphism.

Finally, consider  $[a] \in k[W]$  for some  $a \in k$ . Then  $[a]$  is a constant function on  $W$  with value  $a$ , and it follows that  $\alpha^*([a]) = [a] \circ \alpha$  is constant on  $V$ , again with value  $a$ . Thus,  $\alpha^*([a]) = [a]$ , so that  $\alpha^*$  is the identity on constants.

(ii) Now let  $f : k[W] \rightarrow k[V]$  be a ring homomorphism which is the identity on the constants. We need to show that  $f$  comes from a polynomial mapping  $\alpha : V \rightarrow W$ . Since  $W \subset k^n$  has coordinates  $y_1, \dots, y_n$ , we get coordinate functions  $[y_i] \in k[W]$ .

Then  $f([y_i]) \in k[V]$ , and since  $V \subset k^m$  has coordinates  $x_1, \dots, x_m$ , we can write  $f([y_i]) = [a_i(x_1, \dots, x_m)] \in k[V]$  for some polynomial  $a_i \in k[x_1, \dots, x_m]$ . Then consider the polynomial mapping

$$\alpha = (a_1(x_1, \dots, x_m), \dots, a_n(x_1, \dots, x_m)).$$

We need to show that  $\alpha$  maps  $V$  to  $W$  and that  $f = \alpha^*$ .

Given any polynomial  $F \in k[y_1, \dots, y_n]$ , we first claim that

$$(2) \quad [F \circ \alpha] = f([F])$$

in  $k[V]$ . To prove this, note that

$$[F \circ \alpha] = [F(a_1, \dots, a_n)] = F([a_1], \dots, [a_n]) = F(f([y_1]), \dots, f([y_n])),$$

where the second equality follows from the definition of sum and product in  $k[V]$ , and the third follows from  $[a_i] = f([y_i])$ . But  $[F] = [F(y_1, \dots, y_n)]$  is a  $k$ -linear combination of products of the  $[y_i]$ , so that

$$F(f([y_1]), \dots, f([y_n])) = f([F(y_1, \dots, y_n)]) = f([F])$$

since  $f$  is a ring homomorphism which is the identity on  $k$  (see Exercise 10). Equation (2) follows immediately.

We can now prove that  $\alpha$  maps  $V$  to  $W$ . Given a point  $(c_1, \dots, c_m) \in V$ , we must show that  $\alpha(c_1, \dots, c_m) \in W$ . If  $F \in \mathbf{I}(W)$ , then  $[F] = 0$  in  $k[W]$ , and since  $f$  is a ring homomorphism, we have  $f([F]) = 0$  in  $k[V]$ . By (2), this implies that  $[F \circ \alpha]$  is the zero function on  $V$ . In particular,

$$[F \circ \alpha](c_1, \dots, c_m) = F(\alpha(c_1, \dots, c_m)) = 0.$$

Since  $F$  was an arbitrary element of  $\mathbf{I}(W)$ , this shows  $\alpha(c_1, \dots, c_m) \in W$ , as desired.

Once we know  $\alpha$  maps  $V$  to  $W$ , equation (2) implies that  $[F] \circ \alpha = f([F])$  for any  $[F] \in k[W]$ . Since  $\alpha^*([F]) = [F] \circ \alpha$ , this proves  $f = \alpha^*$ . It remains to show that  $\alpha$  is uniquely determined. So suppose we have  $\beta : V \rightarrow W$  such that  $f = \beta^*$ . If  $\beta$  is represented by

$$\beta(x_1, \dots, x_m) = (b_1(x_1, \dots, x_m), \dots, b_n(x_1, \dots, x_m)),$$

then note that  $\beta^*([y_i]) = [y_i] \circ \beta = [b_i(x_1, \dots, x_m)]$ . A similar computation gives  $\alpha^*([y_i]) = [a_i(x_1, \dots, x_m)]$ , and since  $\alpha^* = f = \beta^*$ , we have  $[a_i] = [b_i]$  for all  $i$ . Then  $a_i$  and  $b_i$  give the same polynomial function on  $V$ , and, hence,  $\alpha = (a_1, \dots, a_n)$  and  $\beta = (b_1, \dots, b_n)$  define the same mapping on  $V$ . This shows  $\alpha = \beta$ , and uniqueness is proved.  $\square$

Now suppose that  $\alpha : V \rightarrow W$  and  $\beta : W \rightarrow V$  are inverse polynomial mappings. Then  $\alpha \circ \beta = \text{id}_W$ , where  $\text{id}_W : W \rightarrow W$  is the identity map. By general properties of functions, this implies  $(\alpha \circ \beta)^*(\phi) = \text{id}_W^*(\phi) = \phi \circ \text{id}_W = \phi$  for all  $\phi \in k[W]$ . However, we also have

$$(3) \quad \begin{aligned} (\alpha \circ \beta)^*(\phi) &= \phi \circ (\alpha \circ \beta) = (\phi \circ \alpha) \circ \beta \\ &= \alpha^*(\phi) \circ \beta = \beta^*(\alpha^*(\phi)) = (\beta^* \circ \alpha^*)(\phi). \end{aligned}$$

Hence,  $(\alpha \circ \beta)^* = \beta^* \circ \alpha^* = \text{id}_{k[W]}$  as a mapping from  $k[W]$  to itself. Similarly, one can show that  $(\beta \circ \alpha)^* = \alpha^* \circ \beta^* = \text{id}_{k[V]}$ . This proves the first half of the following theorem.

**Theorem 9.** *Two affine varieties  $V \subset k^m$  and  $W \subset k^n$  are isomorphic if and only if there is an isomorphism  $k[V] \cong k[W]$  of coordinate rings which is the identity on constant functions.*

**Proof.** The above discussion shows that if  $V$  and  $W$  are isomorphic varieties, then  $k[V] \rightarrow k[W]$  as rings. Proposition 8 shows that the isomorphism is the identity on constants.

For the converse, we must show that if we have a ring isomorphism  $f : k[W] \rightarrow k[V]$  which is the identity on  $k$ , then  $f$  and  $f^{-1}$  “come from” inverse polynomial mappings between  $V$  and  $W$ . By part (ii) of Proposition 8, we know that  $f = \alpha^*$  for some  $\alpha : V \rightarrow W$  and  $f^{-1} = \beta^*$  for  $\beta : W \rightarrow V$ . We need to show that  $\alpha$  and  $\beta$  are inverse mappings. First consider the composite map  $\alpha \circ \beta : W \rightarrow W$ . This is clearly a polynomial map, and, using the argument from (3), we see that for any  $\phi \in k[W]$ ,

$$(4) \quad (\alpha \circ \beta)^*(\phi) = \beta^*(\alpha^*(\phi)) = f^{-1}(f(\phi)) = \phi.$$

It is also easy to check that the identity map  $\text{id}_W : W \rightarrow W$  is a polynomial map on  $W$ , and we saw above that  $\text{id}_W^*(\phi) = \phi$  for all  $\phi \in k[W]$ . From (4), we conclude that  $(\alpha \circ \beta)^* = \text{id}_W^*$ , and then  $\alpha \circ \beta = \text{id}_W$  follows from the uniqueness statement of part (ii) of Proposition 8. In a similar way, one proves that  $\beta \circ \alpha = \text{id}_V$ , and hence  $\alpha$  and  $\beta$  are inverse mappings. This completes the proof of the theorem.  $\square$

We conclude with several examples to illustrate isomorphisms of varieties and the corresponding isomorphisms of their coordinate rings.

Let  $A$  be an invertible  $n \times n$  matrix with entries in  $k$  and consider the linear mapping  $L_A : k^n \rightarrow k^n$  defined by  $L_A(x) = Ax$ , where  $Ax$  is the matrix product. From Exercise 9 of Chapter 4, §1, we know that  $L_A^*$  is a ring isomorphism from  $k[x_1, \dots, x_n]$  to itself. Hence, by the theorem,  $L_A$  is an isomorphism of varieties taking  $k^n$  to itself. (Such isomorphisms are often called *automorphisms* of a variety.) In Exercise 9, you will show that if  $V$  is any subvariety of  $k^n$ , then  $L_A(V)$  is a subvariety of  $k^n$  isomorphic to  $V$  since  $L_A$  restricts to give an isomorphism of  $V$  onto  $L_A(V)$ . For example, the curve we studied in the final example of §1 of this chapter was obtained from the “standard” twisted cubic curve in  $\mathbb{C}^3$  by an invertible linear mapping. Refer to equation (5) of §1 and see if you can identify the mapping  $L_A$  that was used.

Next, let  $f(x, y) \in k[x, y]$  and consider the *graph* of the polynomial function on  $k^2$  given by  $f$  [that is, the variety  $V = \mathbf{V}(z - f(x, y)) \subset k^3$ ]. Generalizing what we said concerning the variety  $\mathbf{V}(z - xy)$  in analyzing the curve given in Example 7, it will always be the case that a graph  $V$  is isomorphic as a variety to  $k^2$ . The reason is that the projection on the  $(x, y)$ -plane  $\pi : V \rightarrow k^2$ , and the parametrization of the graph given by  $\alpha : k^2 \rightarrow V, \alpha(x, y) = (x, y, f(x, y))$  are inverse mappings. The isomorphism of coordinate rings corresponding to  $\alpha$  just consists of substituting  $z = f(x, y)$  into every polynomial function  $F(x, y, z)$  on  $V$ .

Finally, consider the curve  $V = \mathbf{V}(y^5 - x^2)$  in  $\mathbb{R}^2$ .

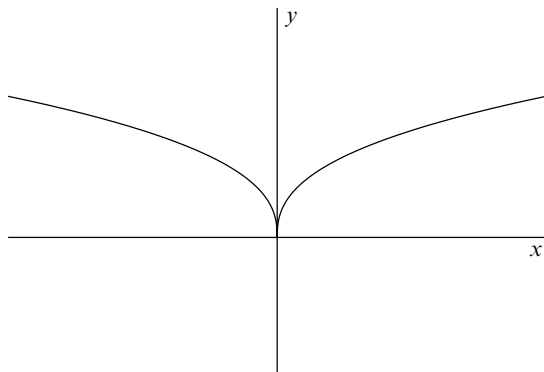

We claim that  $V$  is *not* isomorphic to  $\mathbb{R}$  as a variety, even though there is a one-to-one polynomial mapping from  $V$  to  $\mathbb{R}$  given by projecting  $V$  onto the  $x$ -axis. The reason lies in the coordinate ring of  $V$ :  $\mathbb{R}[V] = \mathbb{R}[x, y]/\langle y^5 - x^2 \rangle$ . If there were an isomorphism  $\alpha : \mathbb{R} \rightarrow V$ , then the “pullback”  $\alpha^* : \mathbb{R}[V] \rightarrow \mathbb{R}[u]$  would be a ring isomorphism given by

$$\begin{aligned}\alpha^*([x]) &= c(u), \\ \alpha^*([y]) &= d(u),\end{aligned}$$

where  $c(u), d(u) \in \mathbb{R}[u]$  are polynomials. Since  $y^5 - x^2$  represents the zero function on  $V$ , we must have  $\alpha^*([y^5 - x^2]) = (d(u))^5 - (c(u))^2 = 0$  in  $\mathbb{R}[u]$ .

We may assume that  $c(0) = d(0) = 0$  since the parametrization  $\alpha$  can be “arranged” so that  $\alpha(0) = (0, 0) \in V$ . But then let us examine the possible polynomial solutions

$$c(u) = c_1u + c_2u^2 + \cdots, \quad d(u) = d_1u + d_2u^2 + \cdots$$

of the equation  $(c(u))^2 = (d(u))^5$ . Since  $(d(u))^5$  contains no power of  $u$  lower than  $u^5$ , the same must be true of  $(c(u))^2$ . However,

$$(c(u))^2 = c_1^2u^2 + 2c_1c_2u^3 + (c_2^2 + 2c_1c_3)u^4 + \cdots.$$

The coefficient of  $u^2$  must be zero, which implies  $c_1 = 0$ . The coefficient of  $u^4$  must also be zero, which implies  $c_2 = 0$  as well. Since  $c_1, c_2 = 0$ , the smallest power of  $u$  that can appear in  $c^2$  is  $u^6$ , which implies that  $d_1 = 0$  also.

It follows that  $u$  cannot be in the image of  $\alpha^*$  since the image of  $\alpha^*$  consists of polynomials in  $c(u)$  and  $d(u)$ . This is a contradiction since  $\alpha^*$  was supposed to be a ring isomorphism *onto*  $\mathbb{R}[u]$ . Thus, our two varieties are not isomorphic. In the exercises, you will derive more information about  $\mathbb{R}[V]$  by the method of §3 to yield another proof that  $\mathbb{R}[V]$  is not isomorphic to a polynomial ring in one variable.

#### EXERCISES FOR §4

1. Let  $C$  be the twisted cubic curve in  $k^3$ .
  - a. Show that  $C$  is a subvariety of the surface  $S = \mathbf{V}(xz - y^2)$ .
  - b. Find an ideal  $J \subset k[S]$  such that  $C = \mathbf{V}_S(J)$ .

2. Let  $V \subset \mathbb{C}^n$  be a nonempty affine variety.
  - a. Let  $\phi \in \mathbb{C}[V]$ . Show that  $\mathbf{V}_V(\phi) = \emptyset$  if and only if  $\phi$  is invertible in  $\mathbb{C}[V]$  (which means that there is some  $\psi \in \mathbb{C}[V]$  such that  $\phi\psi = [1]$  in  $\mathbb{C}[V]$ ).
  - b. Is the statement of part (a) true if we replace  $\mathbb{C}$  by  $\mathbb{R}$ ? If so, prove it; if not, give a counterexample.
3. Prove parts (ii), (iii), and (iv) of Proposition 3.
4. Let  $V = \mathbf{V}(y - x^n, z - x^m)$ , where  $m, n$  are any integers  $\geq 1$ . Show that  $V$  is isomorphic as a variety to  $k$  by constructing explicit inverse polynomial mappings  $\alpha : k \rightarrow V$  and  $\beta : V \rightarrow k$ .
5. Show that any surface in  $k^3$  with a defining equation of the form  $x - f(y, z) = 0$  or  $y - g(x, z) = 0$  is isomorphic as a variety to  $k^2$ .
6. Let  $V$  be a variety in  $k^n$  defined by a single equation of the form  $x_n - f(x_1, \dots, x_{n-1}) = 0$ . Show that  $V$  is isomorphic as a variety to  $k^{n-1}$ .
7. In this exercise, we will derive the parametrization (1) for the projected curve  $\pi(C)$  from Example 7.

- a. Show that every hyperbola in  $\mathbb{R}^2$  whose asymptotes are horizontal and vertical and which passes through the points  $(0, 0)$  and  $(1, 1)$  is defined by an equation of the form

$$xy + tx - (t + 1)y = 0$$

for some  $t \in \mathbb{R}$ .

- b. Using a computer algebra system, compute a Groebner basis for the ideal generated by the equation of  $\pi(C)$ , and the above equation of the hyperbola. Use lex order with the variables ordered  $x > y > t$ .
- c. The Groebner basis will contain one polynomial depending on  $y, t$  only. By collecting powers of  $y$  and factoring, show that this polynomial has  $y = 0$  as a double root,  $y = 1$  as a single root, and one root which depends on  $t : y = \frac{-t^2+t+1}{t(t+2)}$ .
- d. Now consider the other elements of the basis and show that for the “movable” root from part (c) there is a unique corresponding  $x$  value given by the first equation in (1).

The method sketched in Exercise 7 probably seems exceedingly *ad hoc*, but it is an example of a general pattern that can be developed with some more machinery concerning algebraic curves. Using the complex projective plane to be introduced in Chapter 8, it can be shown that  $\pi(C)$  is contained in a projective algebraic curve with *three* singular points similar to the one at  $(0, 0)$  in the sketch. Using the family of conics passing through all three singular points and any one additional point, we can give a rational parametrization for *any* irreducible quartic curve with three singular points as in this example. However, *nonsingular* quartic curves have no such parametrizations.

8. Let  $Q_1 = \mathbf{V}(x^2 + y^2 + z^2 - 1)$ , and  $Q_2 = \mathbf{V}((x - 1/2)^2 - 3y^2 - 2z^2)$  in  $\mathbb{R}^3$ .
  - a. Using the idea of Example 7 and Exercise 5, find a surface in the pencil defined by  $Q_1$  and  $Q_2$  that is isomorphic as a variety to  $\mathbb{R}^2$ .
  - b. Describe and/or sketch the intersection curve  $Q_1 \cap Q_2$ .
9. Let  $\alpha : V \rightarrow W$  and  $\beta : W \rightarrow V$  be inverse polynomial mappings between two isomorphic varieties  $V$  and  $W$ . Let  $U = \mathbf{V}_V(I)$  for some ideal  $I \subset k[V]$ . Show that  $\alpha(U)$  is a subvariety of  $W$  and explain how to find an ideal  $J \subset k[W]$  such that  $\alpha(U) = \mathbf{V}_W(J)$ .
10. Let  $f : k[V] \rightarrow k[W]$  be a ring homomorphism of coordinate rings which is the identity on constants. Suppose that  $V \subset k^m$  with coordinates  $x_1, \dots, x_m$ . If  $F \in k[x_1, \dots, x_m]$ , then prove that  $f([F]) = F(f([x_1]), \dots, f([x_m]))$ . Hint: Express  $[F]$  as a  $k$ -linear combination of products of the  $[x_i]$ .
11. This exercise will study the example following Definition 2 where  $V = \mathbf{V}(z - x^2 - y^2) \subset \mathbb{R}^3$ .



- a. Show that the subvariety  $W = \{(1, 1, 2)\} \subset V$  is equal to  $\mathbf{V}_V([x - 1], [y - 1])$ . Explain why this implies that  $\langle [x - 1], [y - 1] \rangle \subset \mathbf{I}_V(W)$ .
- b. Prove that  $\langle [x - 1], [y - 1] \rangle = \mathbf{I}_V(W)$ . Hint: Show that  $V$  is isomorphic to  $\mathbb{R}^2$  and use Exercise 9.
12. Let  $V = \mathbf{V}(y^2 - 3x^2z + 2) \subset \mathbb{R}^3$  and let  $L_A$  be the linear mapping on  $\mathbb{R}^3$  defined by the matrix

$$A = \begin{pmatrix} 2 & 0 & 1 \\ 1 & 1 & 0 \\ 0 & 1 & 1 \end{pmatrix}.$$

- a. Verify that  $L_A$  is an isomorphism from  $\mathbb{R}^3$  to  $\mathbb{R}^3$ .
- b. Find the equation of the image of  $V$  under  $L_A$ .
13. In this exercise, we will rotate the twisted cubic in  $\mathbb{R}^3$ .
- a. Find the matrix  $A$  of the linear mapping on  $\mathbb{R}^3$  that rotates every point through an angle of  $\pi/6$  counterclockwise about the  $z$ -axis.
- b. What are the equations of the image of the standard twisted cubic curve under the linear mapping defined by the rotation matrix  $A$ ?
14. This exercise will outline another proof that  $V = \mathbf{V}(y^5 - x^2) \subset \mathbb{R}^2$  is not isomorphic to  $\mathbb{R}$  as a variety. This proof will use the algebraic structure of  $\mathbb{R}[V]$ . We will show that there is no ring isomorphism from  $\mathbb{R}[V]$  to  $\mathbb{R}[t]$ . (Note that  $\mathbb{R}[t]$  is the coordinate ring of  $\mathbb{R}$ .)
- a. Using the techniques of §3, explain how each element of  $\mathbb{R}[V]$  can be uniquely represented by a polynomial of the form  $a(y) + b(y)x$ , where  $a, b \in \mathbb{R}[y]$ .
- b. Express the product  $(a + bx)(a' + b'x)$  in  $\mathbb{R}[V]$  in the form given in part (a).
- c. Aiming for a contradiction, suppose that there were some ring isomorphism  $\alpha : \mathbb{R}[t] \rightarrow \mathbb{R}[V]$ . Since  $\alpha$  is assumed to be onto,  $x = \alpha(f(t))$  and  $y = \alpha(g(t))$  for some polynomials  $f, g$ . Using the unique factorizations of  $f, g$  and the product formula from part (b), deduce a contradiction.
15. Let  $V \subset \mathbb{R}^3$  be the tangent surface of the twisted cubic curve.
- a. Show that the usual parametrization of  $V$  sets up a one-to-one correspondence between the points of  $V$  and the points of  $\mathbb{R}^2$ . Hint: Recall the discussion of  $V$  in Chapter 3, §3. In light of part (a), it is natural to ask whether  $V$  is *isomorphic* to  $\mathbb{R}^2$ . We will show that the answer to this question is *no*.
- b. Show that  $V$  is singular at each point on the twisted cubic curve by using the method of Exercise 12 of Chapter 3, §4. (The tangent surface has what is called a “cuspidal edge” along this curve.)
- c. Show that if  $\alpha : \mathbb{R}^2 \rightarrow V$  is any polynomial parametrization of  $V$ , and  $\alpha(a, b)$  is contained in the twisted cubic itself, then the derivative matrix of  $\alpha$  must have rank strictly less than 2 at  $(a, b)$  (in other words, the columns of the derivative matrix must be linearly dependent there). (Note:  $\alpha$  need not be the standard parametrization, although the statement will be true also for that parametrization.)
- d. Now suppose that the polynomial parametrization  $\alpha$  has a polynomial inverse mapping  $\beta : V \rightarrow \mathbb{R}^2$ . Using the chain rule from multivariable calculus, show that part (c) gives a contradiction if we consider  $(a, b)$  such that  $\alpha(a, b)$  is on the twisted cubic.

## §5 Rational Functions on a Variety

The ring of integers can be embedded in many fields. The *smallest* of these is the field of rational numbers  $\mathbb{Q}$  because  $\mathbb{Q}$  is formed by constructing fractions  $\frac{m}{n}$ , where  $m, n \in \mathbb{Z}$ .

Nothing more than integers was used. Similarly, the polynomial ring  $k[x_1, \dots, x_n]$  is included as a subring in the field of *rational functions*

$$k(x_1, \dots, x_n) = \left\{ \frac{f(x_1, \dots, x_n)}{g(x_1, \dots, x_n)} : f, g \in k[x_1, \dots, x_n], g \neq 0 \right\}.$$

Generalizing these examples, if  $R$  is any integral domain, then we can form what is called the *quotient field*, or *field of fractions* of  $R$ , denoted  $QF(R)$ . The elements of  $QF(R)$  are thought of as “fractions”  $r/s$ , where  $r, s \in R$  and  $s \neq 0$ . We add and multiply elements of  $QF(R)$  as we do rational numbers or rational functions:

$$r/s + t/u = (ru + ts)/su \quad \text{and} \quad r/s \cdot t/u = rt/su.$$

Note that the assumption that  $R$  is an integral domain ensures that the denominators of the sum and product will be nonzero. In addition, two of these fractions  $r/s$  and  $r'/s'$  represent the same element in the field of fractions if  $rs' = r's$ . It can be checked easily that  $QF(R)$  satisfies all the axioms of a field (see Exercise 1). Furthermore,  $QF(R)$  contains the subset  $\{r/1 : r \in R\}$  which is a subring isomorphic to  $R$  itself. Hence, the terminology “quotient field, or field of fractions of  $R$ ” is fully justified.

Now if  $V \subset k^n$  is an *irreducible* variety, then we have seen in §1 that the coordinate ring  $k[V]$  is an integral domain. The field of fractions  $QF(k[V])$  is given the following name.

**Definition 1.** *Let  $V$  be an irreducible affine variety in  $k^n$ . We call  $QF(k[V])$  the **function field** (or **field of rational functions**) on  $V$ , and we denote this field by  $k(V)$ .*

Note the consistency of our notation. We use  $k[x_1, \dots, x_n]$  for a polynomial ring and  $k[V]$  for the coordinate ring of  $V$ . Similarly, we use  $k(x_1, \dots, x_n)$  for a rational function field and  $k(V)$  for the function field of  $V$ .

We can write the function field  $k(V)$  of  $V \subset k^n$  explicitly as

$$\begin{aligned} k(V) &= \{\phi/\psi : \phi, \psi \in k[V], \psi \neq 0\} \\ &= \{[f]/[g] : f, g \in k[x_1, \dots, x_n], g \notin \mathbf{I}(V)\}. \end{aligned}$$

As with any rational function, we must be careful to avoid zeros of the denominator if we want a well-defined function value in  $k$ . Thus, an element  $\phi/\psi \in k(V)$  defines a function only on the complement of  $\mathbf{V}_V(\psi)$ .

The most basic example of the function field of a variety is given by  $V = k^n$ . In this case, we have  $k[V] = k[x_1, \dots, x_n]$  and, hence,

$$k(V) = k(x_1, \dots, x_n).$$

We next consider some more complicated examples.

**Example 2.** In §4, we showed that the curve

$$V = \mathbf{V}(y^5 - x^2) \subset \mathbb{R}^2$$

is not isomorphic to  $\mathbb{R}$  because the coordinate rings of  $V$  and  $\mathbb{R}$  are not isomorphic. Let us see what we can say about the function field of  $V$ . To begin, note that by the method

of §2, we can represent the elements of  $\mathbb{R}[V]$  by remainders modulo  $G = \{y^5 - x^2\}$ , which is a Groebner basis for  $\mathbf{I}(V)$  with respect to lex order with  $x > y$  in  $\mathbb{R}[x, y]$ . Then  $\mathbb{R}[V] = \{a(y) + xb(y) : a, b \in \mathbb{R}[y]\}$  as a real vector space, and multiplication is defined by

$$(1) \quad (a + xb) \cdot (c + xd) = (ac + y^5 \cdot bd) + x(ad + bc).$$

In Exercise 2, you will show that  $V$  is irreducible, so that  $\mathbb{R}[V]$  is an integral domain.

Now, using this description of  $\mathbb{R}[V]$ , we can also describe the function field  $\mathbb{R}(V)$  as follows. If  $c + xd \neq 0$  in  $\mathbb{R}[V]$ , then in the function field we can write

$$\begin{aligned} \frac{a + xb}{c + xd} &= \frac{a + xb}{c + xd} \cdot \frac{c - xd}{c - xd} \\ &= \frac{(ac - y^5bd) + x(bc - ad)}{c^2 - y^5d^2} \\ &= \frac{ac - y^5bd}{c^2 - y^5d^2} + x \frac{bc - ad}{c^2 - y^5d^2}. \end{aligned}$$

This is an element of  $\mathbb{R}(y) + x\mathbb{R}(y)$ . Conversely, it is clear that every element of  $\mathbb{R}(y) + x\mathbb{R}(y)$  defines an element of  $\mathbb{R}(V)$ . Hence, the field  $\mathbb{R}(V)$  can be identified with the set of functions  $\mathbb{R}(y) + x\mathbb{R}(y)$ , where the addition and multiplication operations are defined as before in  $\mathbb{R}[V]$ , only using rational functions of  $y$  rather than polynomials.

Now consider the mappings:

$$\begin{aligned} \alpha : V &\longrightarrow \mathbb{R}, (x, y) \mapsto x/y^2, \\ \beta : \mathbb{R} &\longrightarrow V, u \mapsto (u^5, u^2). \end{aligned}$$

Note that  $\alpha$  is defined except at  $(0, 0) \in V$ , whereas  $\beta$  is a polynomial parametrization of  $V$ . As in §4, we can use  $\alpha$  and  $\beta$  to define mappings “going in the opposite direction” on functions. However, since  $\alpha$  itself is defined as a rational function, we will not stay within  $\mathbb{R}[V]$  if we compose  $\alpha$  with a function in  $\mathbb{R}[u]$ . Hence, we will consider the maps

$$\begin{aligned} \alpha^* : \mathbb{R}(u) &\longrightarrow \mathbb{R}(V), f(u) \mapsto f(x/y^2), \\ \beta^* : \mathbb{R}(V) &\longrightarrow \mathbb{R}(u), a(y) + xb(y) \mapsto a(u^2) + u^5b(u^2). \end{aligned}$$

We claim that  $\alpha^*$  and  $\beta^*$  are inverse ring isomorphisms. That  $\alpha^*$  and  $\beta^*$  preserve sums and products follows by the argument given in the proof of Proposition 8 from §4. To check that  $\alpha^*$  and  $\beta^*$  are inverses, first we have that for any  $f(u) \in \mathbb{R}(u)$ ,  $\alpha^*(f) = f(x/y^2)$ . Hence,  $\beta^*(\alpha^*(f)) = f(u^5/(u^2)^2) = f(u)$ . Therefore,  $\beta^* \circ \alpha^*$  is the identity on  $\mathbb{R}(u)$ . Similarly, if  $a(y) + xb(y) \in \mathbb{R}(V)$ , then  $\beta^*(a + xb) = a(u^2) + u^5b(u^2)$ , so

$$\begin{aligned} \alpha^*(\beta^*(a + xb)) &= a((x/y^2)^2) + (x/y^2)^5b((x/y^2)^2) \\ &= a(x^2/y^4) + (x^5/y^{10})b(x^2/y^4). \end{aligned}$$

However, in  $\mathbb{R}(V)$ ,  $x^2 = y^5$ , so  $x^2/y^4 = y$ , and  $x^5/y^{10} = xy^{10}/y^{10} = x$ . Hence,  $\alpha^* \circ \beta^*$  is the identity on  $\mathbb{R}(V)$ . Thus,  $\alpha^*, \beta^*$  define ring isomorphisms between the function fields  $\mathbb{R}(V)$  and  $\mathbb{R}(u)$ .

Example 2 shows that it is possible for two varieties to have the same (i.e., isomorphic) function fields, even when they are not isomorphic. It also gave us an example of a rational mapping between two varieties. Before we give a precise definition of a rational mapping, let us look at another example.

**Example 3.** Let  $Q = \mathbf{V}(x^2 + y^2 - z^2 - 1)$ , a hyperboloid of one sheet in  $\mathbb{R}^3$ , and let  $W = \mathbf{V}(x + 1)$ , the plane  $x = -1$ . Let  $p = (1, 0, 0) \in Q$ . For any  $q \in Q - \{p\}$ , we construct the line  $L_q$  joining  $p$  and  $q$ , and we define a mapping  $\phi$  to  $W$  by setting

$$\phi(q) = L_q \cap W$$

if the line intersects  $W$ . (If the line does not intersect  $W$ , then  $\phi(q)$  is undefined.) We can find an algebraic formula for  $\phi$  as follows. If  $q = (x_0, y_0, z_0) \in Q$ , then  $L_q$  is given in parametric form by

$$(2) \quad \begin{aligned} x &= 1 + t(x_0 - 1), \\ y &= ty_0, \\ z &= tz_0. \end{aligned}$$

At  $\phi(q) = L_q \cap W$ , we must have  $1 + t(x_0 - 1) = -1$ , so  $t = \frac{-2}{x_0 - 1}$ . From (2), it follows that

$$(3) \quad \phi(q) = \left( -1, \frac{-2y_0}{x_0 - 1}, \frac{-2z_0}{x_0 - 1} \right).$$

This shows that  $\phi$  is defined on all of  $Q$  except for the points on the two lines

$$Q \cap \mathbf{V}(x - 1) = \{(1, t, t) : t \in \mathbb{R}\} \cup \{(1, t, -t) : t \in \mathbb{R}\}.$$

We will call  $\phi : Q - \mathbf{V}_Q(x - 1) \rightarrow W$  a *rational mapping* on  $Q$  since the components of  $\phi$  are rational functions. [We can think of them as elements of  $\mathbb{R}(Q)$  if we like.]

Going in the other direction, if  $(-1, a, b) \in W$ , then the line  $L$  through  $p = (1, 0, 0)$  and  $(-1, a, b)$  can be parametrized by

$$\begin{aligned} x &= 1 - 2t, \\ y &= ta, \\ z &= tb, \end{aligned}$$

Computing the intersections with  $Q$ , we find

$$L \cap Q = \left\{ (1, 0, 0), \left( \frac{a^2 - b^2 - 4}{a^2 - b^2 + 4}, \frac{4a}{a^2 - b^2 + 4}, \frac{4b}{a^2 - b^2 + 4} \right) \right\}.$$

Thus, if we let  $H$  denote the hyperbola  $\mathbf{V}_W(a^2 - b^2 + 4)$ , then we can define a second rational mapping

$$\psi : W - H \longrightarrow Q$$

by

$$(4) \quad \psi(-1, a, b) = \left( \frac{a^2 - b^2 - 4}{a^2 - b^2 + 4}, \frac{4a}{a^2 - b^2 + 4}, \frac{4b}{a^2 - b^2 + 4} \right).$$

From the geometric descriptions of  $\phi$  and  $\psi$ ,  $\phi \circ \psi$  is the identity mapping on the subset  $W - H \subset W$ . Similarly, we see that  $\psi \circ \phi$  is the identity on  $Q - \mathbf{V}_Q(x - 1)$ . Also, using the formulas from equations (3) and (4), it can be checked that  $\phi^* \circ \psi^*$  and  $\psi^* \circ \phi^*$  are the identity mappings on the function fields. (We should mention that as in the second example,  $Q$  and  $W$  are *not* isomorphic varieties. However this is not an easy fact to prove given what we know.)

We now introduce some general terminology that was implicit in the above examples.

**Definition 4.** Let  $V \subset k^m$  and  $W \subset k^n$  be irreducible affine varieties. A **rational mapping** from  $V$  to  $W$  is a function  $\phi$  represented by

$$(5) \quad \phi(x_1, \dots, x_m) = \left( \frac{f_1(x_1, \dots, x_m)}{g_1(x_1, \dots, x_m)}, \dots, \frac{f_n(x_1, \dots, x_m)}{g_n(x_1, \dots, x_m)} \right),$$

where  $f_i/g_i \in k(x_1, \dots, x_m)$  satisfy:

- (i)  $\phi$  is defined at some point of  $V$ .
- (ii) For every  $(a_1, \dots, a_m) \in V$  where  $\phi$  is defined,  $\phi(a_1, \dots, a_m) \in W$ .

Note that a rational mapping  $\phi$  from  $V$  to  $W$  may fail to be a *function* from  $V$  to  $W$  in the usual sense because, as we have seen in the examples,  $\phi$  may not be defined everywhere on  $V$ . For this reason, many authors use a special notation to indicate a rational mapping:

$$\phi : V \dashrightarrow W.$$

We will follow this convention as well. By condition (i), the set of points of  $V$  when the rational mapping  $\phi$  in (5) is defined includes  $V - \mathbf{V}_V(g_1 \cdots g_n) = V - (\mathbf{V}_V(g_1) \cup \cdots \cup \mathbf{V}_V(g_n))$ , where  $\mathbf{V}_V(g_1 \cdots g_n)$  is a proper subvariety of  $V$ .

Because rational mappings are not defined everywhere on their domains, we must exercise some care in studying them. In particular, we will need the following precise definition of when two rational mappings are to be considered equal.

**Definition 5.** Let  $\phi, \psi : V \dashrightarrow W$  be rational mappings represented by

$$\phi = \left( \frac{f_1}{g_1}, \dots, \frac{f_n}{g_n} \right) \quad \text{and} \quad \psi = \left( \frac{h_1}{k_1}, \dots, \frac{h_n}{k_n} \right).$$

Then we say that  $\phi = \psi$  if for each  $i$ ,  $1 \leq i \leq n$ ,

$$f_i k_i - h_i g_i \in \mathbf{I}(V).$$

We have the following geometric criterion for the equality of rational mappings.

**Proposition 6.** *Two rational mappings  $\phi, \psi : V \dashrightarrow W$  are equal if and only if there is a proper subvariety  $V' \subset V$  such that  $\phi$  and  $\psi$  are defined on  $V - V'$  and  $\phi(p) = \psi(p)$  for all  $p \in V - V'$ .*

**Proof.** We will assume that  $\phi = (f_1/g_1, \dots, f_n/g_n)$  and  $\psi = (h_1/k_1, \dots, h_n/k_n)$ . First, suppose that  $\phi$  and  $\psi$  are equal as in Definition 5 and let  $V_1 = \mathbf{V}_V(g_1 \cdots g_n)$  and  $V_2 = \mathbf{V}_V(k_1 \cdots k_n)$ . By hypothesis,  $V_1$  and  $V_2$  are proper subvarieties of  $V$ , and since  $V$  is irreducible, it follows that  $V' = V_1 \cup V_2$  is also a proper subvariety of  $V$ . Then  $\phi$  and  $\psi$  are defined on  $V - V'$ , and since  $f_i k_i - h_i g_i \in \mathbf{I}(V)$ , it follows that  $f_i/g_i$  and  $h_i/k_i$  give the same function on  $V - V'$ . Hence, the same is true for  $\phi$  and  $\psi$ .

Conversely, suppose that  $\phi$  and  $\psi$  are defined and equal (as functions) on  $V - V'$ . This implies that for each  $i$ , we have  $f_i/g_i = h_i/k_i$  on  $V - V'$ . Then  $f_i k_i - h_i g_i$  vanishes on  $V - V'$ , which shows that  $V = \mathbf{V}(f_i k_i - h_i g_i) \cup V'$ . Since  $V$  is irreducible and  $V'$  is a proper subvariety, this forces  $V = \mathbf{V}(f_i k_i - h_i g_i)$ . Thus,  $f_i k_i - h_i g_i \in \mathbf{I}(V)$ , as desired.  $\square$

As an example, recall from Example 3 that we had rational maps  $\phi : Q \dashrightarrow W$  and  $\psi : W \dashrightarrow Q$  such that  $\phi \circ \psi$  was the identity on  $W - H \subset W$ . By Proposition 6, this proves that  $\phi \circ \psi$  equals the identity map  $\text{id}_W$  in the sense of Definition 5.

We also need to be careful in dealing with the composition of rational mappings.

**Definition 7.** *Given  $\phi : V \dashrightarrow W$  and  $\psi : W \dashrightarrow Z$ , we say that  $\psi \circ \phi$  is **defined** if there is a point  $p \in V$  such that  $\phi$  is defined at  $p$  and  $\psi$  is defined at  $\phi(p)$ .*

When a composition  $\psi \circ \phi$  is defined, it gives us a rational mapping as follows.

**Proposition 8.** *Let  $\phi : V \dashrightarrow W$  and  $\psi : W \dashrightarrow Z$  be rational mappings such that  $\psi \circ \phi$  is defined. Then there is a proper subvariety  $V' \subset V$  such that:*

- (i)  $\phi$  is defined on  $V - V'$  and  $\psi$  is defined on  $\phi(V - V')$ .
- (ii)  $\psi \circ \phi : V \dashrightarrow Z$  is a rational mapping defined on  $V - V'$ .

**Proof.** Suppose that  $\phi$  and  $\psi$  are represented by

$$\begin{aligned} \phi(x_1, \dots, x_m) &= \left( \frac{f_1(x_1, \dots, x_m)}{g_1(x_1, \dots, x_m)}, \dots, \frac{f_n(x_1, \dots, x_m)}{g_n(x_1, \dots, x_m)} \right). \\ \psi(y_1, \dots, y_n) &= \left( \frac{h_1(y_1, \dots, y_n)}{k_1(y_1, \dots, y_n)}, \dots, \frac{h_l(y_1, \dots, y_n)}{k_l(y_1, \dots, y_n)} \right). \end{aligned}$$

Then the  $j$ -th coordinate of  $\psi \circ \phi$  is

$$\frac{h_j(f_1/g_1, \dots, f_n/g_n)}{k_j(f_1/g_1, \dots, f_n/g_n)},$$

which is clearly a rational function in  $x_1, \dots, x_m$ . To get a quotient of polynomials, we

can write this as

$$\frac{P_j}{Q_j} = \frac{(g_1 \cdots g_n)^M h_j(f_1/g_1, \dots, f_n/g_n)}{(g_1 \cdots g_n)^M k_j(f_1/g_1, \dots, f_n/g_n)},$$

when  $M$  is sufficiently large.

Now set

$$V' = \mathbf{V}_V(\{Q_1 \cdots Q_l g_1 \cdots g_n\}) \subset V.$$

It should be clear that  $\phi$  is defined on  $V - V'$  and  $\psi$  is defined on  $\phi(V - V')$ . It remains to show that  $V' \neq V$ . But by assumption, there is  $p \in V$  such that  $\phi(p)$  and  $\psi(\phi(p))$  are defined. This means that  $g_i(p) \neq 0$  for  $1 \leq i \leq n$  and

$$k_j(f_1(p)/g_1(p), \dots, f_n(p)/g_n(p)) \neq 0$$

for  $1 \leq j \leq l$ . It follows that  $Q_j(p) \neq 0$  and consequently,  $p \in V - V'$ . □

In the exercises, you will work out an example to show how  $\psi \circ \phi$  can fail to be defined. Basically, this happens when the domain of definition of  $\psi$  lies outside the image of  $\phi$ .

Examples 2 and 3 illustrate the following alternative to the notion of *isomorphism* of varieties.

**Definition 9.**

- (i) Two irreducible varieties  $V \subset k^m$  and  $W \subset k^n$  are said to be **birationally equivalent** if there exist rational mappings  $\phi : V \dashrightarrow W$  and  $\psi : W \dashrightarrow V$  such that  $\phi \circ \psi$  is defined (as in Definition 7) and equal to the identity map  $\text{id}_W$  (as in Definition 5), and similarly for  $\psi \circ \phi$ .
- (ii) A **rational variety** is a variety that is birationally equivalent to  $k^n$  for some  $n$ .

Just as isomorphism of varieties can be detected from the coordinate rings, birational equivalence can be detected from the function fields.

**Theorem 10.** *Two irreducible varieties  $V$  and  $W$  are birationally equivalent if and only if there is an isomorphism of function fields  $k(V) \cong k(W)$  which is the identity on  $k$ . (By definition, two fields are isomorphic if they are isomorphic as commutative rings.)*

**Proof.** The proof is similar to what we did in Theorem 9 of §4. Suppose first that  $V$  and  $W$  are birationally equivalent via  $\phi : V \dashrightarrow W$  and  $\psi : W \dashrightarrow V$ . We will define a pullback mapping  $\phi^* : k(W) \rightarrow k(V)$  by the rule  $\phi^*(f) = f \circ \phi$  and show that  $\phi^*$  is an isomorphism. Unlike the polynomial case, it is not obvious that  $\phi^*(f) = f \circ \phi$  exists for all  $f \in k(W)$ —we need to prove that  $f \circ \phi$  is defined at some point of  $V$ .

We first show that our assumption  $\phi \circ \psi = \text{id}_W$  implies the existence of a proper subvariety  $W' \subset W$  such that

- (6)  $\psi$  is defined on  $W - W'$ ,
- $\phi$  is defined on  $\psi(W - W')$ ,
- $\phi \circ \psi$  is the identity function on  $W - W'$ .

To prove this, we first use Proposition 8 to find a proper subvariety  $W_1 \subset W$  such that  $\psi$  is defined on  $W - W_1$  and  $\phi$  is defined on  $\psi(W - W_1)$ . Also, from Proposition 6, we get a proper subvariety  $W_2 \subset W$  such that  $\phi \circ \psi$  is the identity function on  $W - W_2$ . Since  $W$  is irreducible,  $W' = W_1 \cup W_2$  is a proper subvariety, and it follows easily that (6) holds for this choice of  $W'$ .

Given  $f \in k(W)$ , we can now prove that  $f \circ \phi$  is defined. If  $f$  is defined on  $W - W'' \subset W$ , then we can pick  $q \in W - (W' \cup W'')$  since  $W$  is irreducible. From (6), we get  $p = \psi(q) \in V$  such that  $\phi(p)$  is defined, and since  $\phi(p) = q \notin W''$ , we also know that  $f$  is defined at  $\phi(p)$ . By Definition 4,  $\phi^*(f) = f \circ \phi$  exists as an element of  $k(V)$ .

This proves that we have a map  $\phi^* : k(W) \rightarrow k(V)$ , and  $\phi^*$  is a ring homomorphism by the proof of Proposition 8 from §4. Similarly, we get a ring homomorphism  $\psi^* : k(V) \rightarrow k(W)$ . To show that these maps are inverses of each other, let us look at

$$(\psi^* \circ \phi^*)(f) = f \circ \phi \circ \psi$$

for  $f \in k(W)$ . Using the above notation, we see that  $f \circ \phi \circ \psi$  equals  $f$  as a function on  $W - (W' \cup W'')$ , so that  $f \circ \phi \circ \psi = f$  in  $k(W)$  by Proposition 6. This shows that  $\psi^* \circ \phi^*$  is the identity on  $k(W)$ , and a similar argument shows that  $\phi^* \circ \psi^* = \text{id}_{k(V)}$ . Thus,  $\phi^* : k(W) \rightarrow k(V)$  is an isomorphism of fields. We leave it to the reader to show that  $\phi^*$  is the identity on the constant functions  $k \subset k(W)$ .

The proof of the converse implication is left as an exercise for the reader. Once again the idea is basically the same as in the proof of Theorem 9 of §4. □

In the exercises, you will prove that two irreducible varieties are birationally equivalent if there are “big” subsets (complements of proper subvarieties) that can be put in one-to-one correspondence by rational mappings. For example, the curve  $V = \mathbf{V}(y^5 - x^2)$  from Example 2 is birationally equivalent to  $W = \mathbf{R}$ . You should check that  $V - \{(0, 0)\}$  and  $W - \{0\}$  are in a one-to-one correspondence via the rational mappings  $f$  and  $g$  from equation (1). The birational equivalence between the hyperboloid and the plane in Example 3 works similarly. This example also shows that outside of the “big” subsets, birationally equivalent varieties may be quite different (you will check this in Exercise 14).

As we see from these examples, birational equivalence of irreducible varieties is a *weaker* equivalence relation than isomorphism. By this we mean that the set of varieties birationally equivalent to a given variety will contain many different nonisomorphic varieties. Nevertheless, in the history of algebraic geometry, the classification of varieties up to birational equivalence has received more attention than classification up to isomorphism, perhaps because constructing rational functions on a variety is easier than constructing polynomial functions. There are reasonably complete classifications of irreducible varieties of dimensions 1 and 2 up to birational equivalence, and, recently, significant progress has been made in dimension 3. However, the classification of irreducible varieties of dimension  $\geq 4$  up to birational equivalence is still incomplete and is an area of current research.



## EXERCISES FOR §5

1. Let  $R$  be an integral domain, and let  $QF(R)$  be the field of fractions of  $R$  as described in the text.
  - a. Show that addition is well-defined in  $QF(R)$ . This means that if  $r/s = r'/s'$  and  $t/u = t'/u'$ , then you must show that  $(ru + ts)/su = (r'u' + t's')/s'u'$ . Hint: Remember what it means for two elements of  $QF(R)$  to be equal.
  - b. Show that multiplication is well-defined in  $QF(R)$ .
  - c. Show that the field axioms are satisfied for  $QF(R)$ .
2. As in Example 2, let  $V = \mathbf{V}(y^5 - x^2) \subset \mathbb{R}^2$ .
  - a. Show that  $y^5 - x^2$  is irreducible in  $\mathbb{R}[x, y]$  and prove that  $\mathbf{I}(V) = \langle y^5 - x^2 \rangle$ .
  - b. Conclude that  $\mathbf{R}[V]$  is an integral domain.
3. Show that the singular cubic curve  $\mathbf{V}(y^2 - x^3)$  is a rational variety (birationally equivalent to  $k$ ) by adapting what we did in Example 2.
4. Consider the singular cubic curve  $V_c = \mathbf{V}(y^2 - cx^2 + x^3)$  studied in Exercise 8 of Chapter 1, §3. Using the parametrization given there, prove that  $V_c$  is a rational variety and find subvarieties  $V'_c \subset V_c$  and  $W \subset \mathbb{R}$  such that your rational mappings define a one-to-one correspondence between  $V_c - V'_c$  and  $\mathbb{R} - W$ . Hint: Recall that  $t$  in the parametrization of  $V_c$  is the slope of a line passing through  $(0, 0)$ .
5. Verify that the curve  $\pi(C)$  from Exercise 7 of §4 is a rational variety. Hint: To define a rational inverse of the parametrization we derived in that exercise, you need to solve for  $t$  as a function of  $x$  and  $y$  on the curve. The equation of the hyperbola may be useful.
6. In Example 3, verify directly that (3) and (4) define inverse rational mappings from the hyperboloid of the one sheet to the plane.
7. Let  $S = \mathbf{V}(x^2 + y^2 + z^2 - 1)$  in  $\mathbb{R}^3$  and let  $W = \mathbf{V}(z)$  be the  $(x, y)$ -plane. In this exercise, we will show that  $S$  and  $W$  are birationally equivalent varieties, via an explicit mapping called the stereographic projection. See also Exercise 6 of Chapter 1, §3.
  - a. Derive parametric equations as in (2) for the line  $L_q$  in  $\mathbb{R}^3$  passing through the north pole  $(0, 0, 1)$  of  $S$  and a general point  $q = (x_0, y_0, z_0) \neq (0, 0, 1)$  in  $S$ .
  - b. Using the line from part (a) show that  $\phi(q) = L_q \cap W$  defines a rational mapping  $\phi : S \dashrightarrow \mathbb{R}^2$ . This is called the stereographic projection mapping.
  - c. Show that the rational parametrization of  $S$  given in Exercise 6 of Chapter 1, §3 is the inverse mapping of  $\phi$ .
  - d. Deduce that  $S$  and  $W$  are birationally equivalent varieties and find subvarieties  $S' \subset S$  and  $W' \subset W$  such that  $\phi$  and  $\psi$  put  $S - S'$  and  $W - W'$  into one-to-one correspondence.
8. In Exercise 10 of §1, you showed that there were no nonconstant polynomial mappings from  $\mathbb{R}$  to  $V = \mathbf{V}(y^2 - x^3 + x)$ . In this problem, you will show that there are no nonconstant *rational* mappings either, so  $V$  is not birationally equivalent to  $\mathbb{R}$ . In the process, we will need to consider polynomials with complex coefficients, so the proof will actually show that  $\mathbf{V}(y^2 - x^3 + x) \subset \mathbb{C}^2$  is not birationally equivalent to  $\mathbb{C}$  either. The proof will be by contradiction.
  - a. Start by assuming that  $\alpha : \mathbb{R} \dashrightarrow V$  is a nonconstant rational mapping defined by  $\alpha(t) = (a(t)/b(t), c(t)/d(t))$  with  $a$  and  $b$  relatively prime,  $c$  and  $d$  relatively prime, and  $b, d$  monic. By substituting into the equation of  $V$ , show that  $b^3 = d^2$  and  $c^2 = a^3 - ab^2$ .
  - b. Deduce that  $a, b, a + b$ , and  $a - b$  are all squares of polynomials in  $\mathbb{C}[t]$ . In other words, show that  $a = A^2, b = B^2, a + b = C^2$  and  $a - b = D^2$  for some  $A, B, C, D \in \mathbb{C}[t]$ .
  - c. Show that the polynomials  $A, B \in \mathbb{C}[t]$  from part b are nonconstant and relatively prime and that  $A^4 - B^4$  is the square of a polynomial in  $\mathbb{C}[t]$ .

- d. The key step of the proof is to show that such polynomials cannot exist using *infinite descent*. Suppose that  $A, B \in \mathbb{C}[t]$  satisfy the conclusions of part (c). Prove that there are polynomials  $A_1, B_1, C_1 \in \mathbb{C}[t]$  such that

$$\begin{aligned} A - B &= A_1^2 \\ A + B &= B_1^2 \\ A^2 + B^2 &= C_1^2. \end{aligned}$$

- e. Prove that the polynomials  $A_1, B_1$  from part (d) are relatively prime and nonconstant and that their degrees satisfy

$$\max(\deg(A_1), \deg(B_1)) \leq \frac{1}{2} \max(\deg(A), \deg(B)).$$

Also show that  $A_1^4 - (\sqrt{i}B_1)^4 = A_1^4 + B_1^4$  is the square of a polynomial in  $\mathbb{C}[t]$ . Conclude that  $A_1, \sqrt{i}B_1$  satisfy the conclusions of part (c).

- f. Conclude that if such a pair  $A, B$  exists, then one can repeat parts d and e infinitely many times with decreasing degrees at each step (this is the “infinite descent”). Explain why this is impossible and conclude that our original polynomials  $a, b, c, d$  must be constant.
9. Let  $V$  be an irreducible variety and let  $f \in k(V)$ . If we write  $f = \phi/\psi$ , where  $\phi, \psi \in k[V]$ , then we know that  $f$  is defined on  $V - \mathbf{V}_V(\psi)$ . What is interesting is that  $f$  might make sense on a larger set. In this exercise, we will work out how this can happen on the variety  $V = \mathbf{V}(xz - yw) \subset \mathbb{C}^4$ .
- Prove that  $xz - yw \in \mathbb{C}[x, y, z, w]$  is irreducible. Hint: Look at the total degrees of its factors.
  - Use unique factorization in  $\mathbb{C}[x, y, z, w]$  to prove that  $\langle xz - yw \rangle$  is a prime ideal.
  - Conclude that  $V$  is irreducible and that  $\mathbf{I}(V) = \langle xz - yw \rangle$ .
  - Let  $f = [x]/[y] \in \mathbb{C}(V)$  so that  $f$  is defined on  $V - \mathbf{V}_V([y])$ . Show that  $\mathbf{V}_V([y])$  is the union of planes  $\{(0, 0, z, w) : z, w \in \mathbb{C}\} \cup \{(x, 0, 0, w) : x, w \in \mathbb{C}\}$ .
  - Show that  $f = [w]/[z]$  and conclude that  $f$  is defined everywhere outside of the plane  $\{(x, 0, 0, w) : x, w \in \mathbb{C}\}$ .

Note that what made this possible was that we had two fundamentally different ways of representing the rational function  $f$ . This is part of why rational functions are subtle to deal with.

10. Consider the rational mappings  $\phi : \mathbb{R} \dashrightarrow \mathbb{R}^3$  and  $\psi : \mathbb{R}^3 \dashrightarrow \mathbb{R}$  defined by

$$\phi(t) = (t, 1/t, t^2) \quad \text{and} \quad \psi(x, y, z) = \frac{x + yz}{x - yz}.$$

Show that  $\psi \circ \phi$  is not defined.

- Complete the proof of Theorem 10 by showing that if  $V$  and  $W$  are irreducible varieties and  $k(V) \cong k(W)$  is an isomorphism of their function fields which is the identity on constants, then there are inverse rational mappings  $\phi : V \dashrightarrow W$  and  $\psi : W \dashrightarrow V$ . Hint: Follow the proof of Theorem 9 from §4.
- Suppose that  $\phi : V \dashrightarrow W$  is a rational mapping defined on  $V - V'$ . If  $W' \subset W$  is a subvariety, then prove that

$$V'' = V' \cup \{p \in V - V' : \phi(p) \in W'\}$$

is a subvariety of  $V$ . Hint: Find equations for  $V''$  by substituting the rational functions representing  $\phi$  into the equations for  $W'$  and setting the numerators of the resulting functions equal to zero.

13. Suppose that  $V$  and  $W$  are birationally equivalent varieties via  $\phi : V \dashrightarrow W$  and  $\psi : W \dashrightarrow V$ . As mentioned in the text after the proof of Theorem 10, this means that  $V$  and  $W$  have “big” subsets that are the same. More precisely, there are proper subvarieties  $V_1 \subset V$  and  $W_1 \subset W$  such that  $\phi$  and  $\psi$  induce inverse bijections between subsets  $V - V_1$  and  $W - W_1$ . Note that Exercises 4 and 7 involved special cases of this result.

- a. Let  $V' \subset V$  be the subvariety that satisfies the properties given in (6) for  $\phi \circ \psi$ . Similarly, we get  $W' \subset W$  that satisfies the analogous properties for  $\psi \circ \phi$ . Let

$$\begin{aligned} \mathcal{V} &= \{p \in V - V' : \phi(p) \in W - W'\}, \\ \mathcal{W} &= \{q \in W - W' : \psi(q) \in V - V'\}. \end{aligned}$$

Show that we have bijections  $\phi : \mathcal{V} \rightarrow \mathcal{W}$  and  $\psi : \mathcal{W} \rightarrow \mathcal{V}$  which are inverses of each other.

- b. Use Exercise 12 to prove that  $\mathcal{V} = V - V_1$  and  $\mathcal{W} = W - W_1$  for proper subvarieties  $V_1$  and  $W_1$ .

Parts (a) and (b) give the desired one-to-one correspondence between “big” subsets of  $V$  and  $W$ .

14. In Example 3, we had rational mappings  $\phi : Q \dashrightarrow W$  and  $\psi : W \dashrightarrow Q$ .
- a. Show that  $\phi$  and  $\psi$  induce inverse bijections  $\phi : Q - \mathbf{V}_Q(x - 1) \rightarrow W - H$  and  $\psi : W - H \rightarrow Q - \mathbf{V}_Q(x - 1)$ , where  $H = \mathbf{V}_W(a^2 - b^2 + 4)$ .
- b. Show that  $H$  and  $\mathbf{V}_Q(x - 1)$  are very different varieties that are neither isomorphic nor birationally equivalent.

## §6 (Optional) Proof of the Closure Theorem

This section will complete the proof of the Closure Theorem begun in §2 of Chapter 3. We will use many of the concepts introduced in Chapters 4 and 5, including irreducible varieties and prime ideals from Chapter 4 and quotient rings and fields of fractions from this chapter.

We begin by recalling the basic situation. Let  $k$  be an algebraically closed field, and let  $\pi_l : k^n \rightarrow k^{n-l}$  be projection onto the last  $n - l$  components. If  $V = \mathbf{V}(I)$  is an affine variety in  $k^n$ , then we get the  $l$ -th elimination ideal  $I_l = I \cap k[x_{l+1}, \dots, x_n]$ , and §4 of Chapter 4 proved the first part of the Closure Theorem, which asserts that  $\mathbf{V}(I_l)$  is the smallest variety in  $k^{n-l}$  containing  $\pi_l(V)$ . In the language of Chapter 4, this says that  $\mathbf{V}(I_l)$  is the Zariski closure of  $\pi_l(V)$ .

The remaining part of the Closure Theorem tells us that  $\pi_l(V)$  fills up “most” of  $\mathbf{V}(I_l)$  in the following sense.

**Theorem 1 (The Closure Theorem, second part).** *Let  $k$  be algebraically closed, and let  $V = \mathbf{V}(I) \subset k^n$ . If  $V \neq \emptyset$ , then there is an affine variety  $W \subsetneq \mathbf{V}(I_l)$  such that*

$$\mathbf{V}(I_l) - W \subset \pi_l(V).$$

**Proof.** In Chapter 3, we proved this for  $l = 1$  using resultants. Before tackling the case  $l > 1$ , we note that  $\mathbf{V}(I_l)$  depends only on  $V$  since it is the Zariski closure of  $\pi_l(V)$ . This means that *any* defining ideal  $I$  of  $V$  gives the same  $\mathbf{V}(I_l)$ . In particular, since

$V = \mathbf{V}(\mathbf{I}(V))$ , we can replace  $I$  with  $\mathbf{I}(V)$ . Hence, if  $V$  is irreducible, we can assume that  $I$  is a prime ideal.

Our strategy for proving the theorem is to start with the irreducible case. The following observations will be useful:

$$(1) \quad \begin{aligned} I \text{ is prime} &\implies I_l \text{ is prime} \\ V \text{ is irreducible} &\implies \mathbf{V}(I_l) \text{ is irreducible.} \end{aligned}$$

The first implication is straightforward and is left as an exercise. As for the second, we've seen that we can assume that  $I = \mathbf{I}(V)$ , so that  $I$  is prime. Then  $I_l$  is prime, and the algebra–geometry dictionary (Corollary 4 of Chapter 4, §5) implies that  $\mathbf{V}(I_l)$  is irreducible.

Now suppose that  $V$  is irreducible. We will show that  $\pi_l(V)$  has the desired property by using induction on  $l$  to prove the following slightly stronger result: given a variety  $W_0 \subsetneq V$ , there is a variety  $W_l \subsetneq \mathbf{V}(I_l)$  such that

$$(2) \quad \mathbf{V}(I_l) - W_l \subset \pi_l(V - W_0).$$

We begin with the case  $l = 1$ . Since  $W_0 \neq V$ , we can find  $(a_1, \dots, a_n) \in V - W_0$ . Then there is  $f \in \mathbf{I}(W_0)$  such that  $f(a_1, \dots, a_n) \neq 0$ . The polynomial  $f$  will play a crucial role in what follows. At this point, the proof breaks up into two cases:

*Case I:* Suppose that for all  $(b_2, \dots, b_n) \in \mathbf{V}(I_1)$ , we have  $(b_1, b_2, \dots, b_n) \in V$  for all  $b_1 \in k$ . In this situation, write  $f$  as a polynomial in  $x_1$ :

$$f = \sum_{i=0}^m g_i(x_2, \dots, x_n)x_1^i.$$

Now let  $W_1 = \mathbf{V}(I_1) \cap \mathbf{V}(g_0, \dots, g_m)$ . This variety is strictly smaller than  $\mathbf{V}(I_1)$  since  $f(a_1, \dots, a_n) \neq 0$  implies that  $g_i(a_2, \dots, a_n) \neq 0$  for some  $i$ . Thus  $(a_2, \dots, a_n) \in \mathbf{V}(I_1) - W_1$ , so that  $W_1 \neq \mathbf{V}(I_1)$ .

We next show that (2) is satisfied. If  $(c_2, \dots, c_n) \in \mathbf{V}(I_1) - W_1$ , then some  $g_i$  is nonvanishing at  $(c_2, \dots, c_n)$ , so that  $f(x_1, c_2, \dots, c_n)$  is a nonzero polynomial. Since  $k$  is infinite (Exercise 4 of Chapter 4, §1), we can find  $c_1 \in k$  such that  $f(c_1, c_2, \dots, c_n) \neq 0$ . By the assumption of Case I, the point  $(c_1, \dots, c_n)$  is in  $V$ , yet it can't be in  $W_0$  since  $f$  vanishes on  $W_0$ . This proves that  $(c_2, \dots, c_n) \in \pi_1(V - W_0)$ , which proves (2) in Case I.

*Case II:* Suppose that there is some  $(b_2, \dots, b_n) \in \mathbf{V}(I_1)$  and some  $b_1 \in k$  such that  $(b_1, b_2, \dots, b_n) \notin V$ . In this situation, we can find  $h \in I$  such that  $h(b_1, \dots, b_n) \neq 0$  ( $h$  exists because  $I = \mathbf{I}(V)$ ). Write  $h$  as a polynomial in  $x_1$ :

$$(3) \quad h = \sum_{i=0}^r u_i(x_2, \dots, x_n)x_1^i.$$

Then  $h(b_1, \dots, b_n) \neq 0$  implies  $u_i(b_2, \dots, b_n) \neq 0$  for some  $i$ . Thus,  $u_i \notin I_1$  for some  $i$ . Furthermore, if  $u_r \in I_1$ , then  $h - u_r x_1^r$  is also nonvanishing at  $(b_1, \dots, b_n)$ , so that we can replace  $h$  with  $h - u_r x_1^r$ . Repeating this as often as necessary, we can assume  $u_r \notin I_1$  in (3).

The next claim we want to prove is the following:

$$(4) \quad \text{there exist } v_i \in k[x_2, \dots, x_n] \text{ such that } \sum_{i=0}^r v_i f^i \in I \text{ and } v_0 \notin I_1.$$

To prove this, we will regard  $f$  and  $h$  as polynomials in  $x_1$  and then divide  $f$  by  $h$ . But rather than just use the division algorithm as in §5 of Chapter 1, we will replace  $f$  with  $u_r^{N_1} f$ , where  $N_1$  is some positive integer. We claim that if  $N_1$  is sufficiently large, we can divide  $u_r^{N_1} f$  without introducing any denominators. This means we get an equation of the form

$$u_r^{N_1} f = qh + v_{10} + v_{11}x_1 + \dots + v_{1,r-1}x_1^{r-1},$$

where  $q \in k[x_1, \dots, x_n]$  and  $v_{1i} \in k[x_2, \dots, x_n]$ . We leave the proof of this as Exercise 2, though the reader may also want to consult §5 of Chapter 6, where this process of *pseudodivision* is studied in more detail. Now do the above “division” not just to  $f$  but to all of its powers  $1, f, f^2, \dots, f^r$ . This gives equations of the form

$$(5) \quad u_r^{N_j} f^j = q_j h + v_{j0} + v_{j1}x_1 + \dots + v_{j,r-1}x_1^{r-1}$$

for  $0 \leq j \leq r$ .

Now we will use quotient rings and fields of fractions. We have already seen that  $I_1 = \mathbf{I}(\mathbf{V}(I_1))$ , so that by §2, the quotient ring  $k[x_2, \dots, x_n]/I_1$  is naturally isomorphic to the coordinate ring  $k[\mathbf{V}(I_1)]$ . As in §5, this ring is an integral domain since  $\mathbf{V}(I_1)$  is irreducible, and hence has a field of fractions, which we will denote by  $K$ . We will regard  $k[x_2, \dots, x_n]/I_1$  as a subset of  $K$ , so that a polynomial  $v \in k[x_2, \dots, x_n]$  gives an element  $[v] \in k[x_2, \dots, x_n]/I_1 \subset K$ . In particular, the zero element of  $K$  is  $[0]$ , where  $0 \in k[x_2, \dots, x_n]$  is the zero polynomial.

The polynomials  $v_{ji}$  of (5) give a  $(r + 1) \times r$  matrix

$$\begin{pmatrix} [v_{00}] & \dots & [v_{0,r-1}] \\ \vdots & & \vdots \\ [v_{r0}] & \dots & [v_{r,r-1}] \end{pmatrix}$$

with entries in  $K$ . The rows are  $r + 1$  vectors in the  $r$ -dimensional vector space  $K^r$ , so that the rows are linearly dependent over  $K$ . Thus there are  $\phi_0, \dots, \phi_r \in K$ , not all zero, such that  $\sum_{j=0}^r \phi_j [v_{ji}] = [0]$  in  $K$  for  $0 \leq i \leq r - 1$ . If we write each  $\phi_j$  as a quotient of elements of  $k[x_2, \dots, x_n]/I_1$  and multiply by a common denominator, we can assume that  $\phi_j = [w_j]$  for some  $w_j \in k[x_2, \dots, x_n]$ . Further, the  $\phi_j$  being not all zero in  $k[x_2, \dots, x_n]/I_1 \subset K$  means that at least one  $w_j$  is not in  $I_1$ . Then  $w_0, \dots, w_r$  have the property that

$$\sum_{j=0}^r [w_j][v_{ji}] = [0],$$

which means that

$$(6) \quad \sum_{j=0}^r w_j v_{ji} \in I_1.$$

Finally, if we multiply each equation (5) by the corresponding  $w_j$  and sum for  $0 \leq j \leq r$ , we obtain

$$\sum_{j=0}^r w_j u_r^{N_j} f^j \in I$$

by (6) and the fact that  $h \in I$ . Let  $v_j = w_j u_r^{N_j}$ . Since  $u_r \notin I_1$  and  $w_j \notin I_1$  for some  $j$ , it follows that  $v_j \notin I_1$  for some  $j$  since  $I_1$  is prime by (1).

It remains to arrange for  $v_0 \notin I_1$ . So suppose  $v_0, \dots, v_{t-1} \in I_1$  but  $v_t \notin I_1$ . It follows that

$$f^t \sum_{j=t}^r v_j f^{j-t} \in I.$$

Since  $I$  is prime and  $f \notin I$ , it follows immediately that  $\sum_{j=t}^r v_j f^{j-t} \in I$ . After relabeling so that  $v_t$  is  $v_0$ , we get (4) as desired.

The condition (4) has the following crucial consequence:

$$(7) \quad \pi_1(V) \cap (k^{n-1} - \mathbf{V}(v_0)) \subset \pi_1(V - W_0).$$

This follows because  $\sum_{i=0}^r v_i f^i \in I$ , so that for any  $(c_1, \dots, c_n) \in V$  we have

$$v_0(c_2, \dots, c_n) + f(c_1, \dots, c_n) \sum_{i=1}^r v_i(c_2, \dots, c_n) f(c_1, \dots, c_n)^{i-1} = 0.$$

Then  $v_0(c_2, \dots, c_n) \neq 0$  forces  $f(c_1, \dots, c_n) \neq 0$ , which in turn implies  $(c_1, \dots, c_n) \notin W_0$  (since  $f$  vanishes on  $W_0$ ). From here, (7) follows easily.

We can finally prove (2) in Case II. Since,  $u_r, v_0 \notin I_1$  and  $I_1$  is prime, we see that  $g = u_r v_0 \notin I_1$ . Thus  $W_1 = \mathbf{V}(g) \cap \mathbf{V}(I_1) \subsetneq \mathbf{V}(I_1)$ . To show that (2) holds, let  $(c_2, \dots, c_n) \in \mathbf{V}(I_1) - W_1$ . This means that both  $u_r$  and  $v_0$  are nonvanishing at  $(c_2, \dots, c_n)$ .

If  $I = \langle f_1, \dots, f_s \rangle$ , then  $h \in I$  implies that  $I = \langle h, f_1, \dots, f_s \rangle$ . Since  $u_r(c_2, \dots, c_n) \neq 0$ , the Extension Theorem proved in Chapter 3 implies that  $(c_1, \dots, c_n) \in V$  for some  $c_1 \in \mathbb{C}$ . Then by (7) and  $v_0(c_2, \dots, c_n) \neq 0$ , we see that  $(c_2, \dots, c_n) \in \pi_1(V - W_0)$ , and (2) is proved in Case II.

We have now completed the proof of (2) when  $l = 1$ . In the exercises, you will explore the geometric meaning of the two cases considered above.

Next, suppose that (2) is true for  $l - 1$ . To prove that it holds for  $l$ , take  $W_0 \subsetneq V$ , and apply what we proved for  $l = 1$  to find  $W_1 \subsetneq \mathbf{V}(I_1)$  such that

$$\mathbf{V}(I_1) - W_1 \subset \pi_1(V - W_0).$$

Now observe that  $I_l$  is the  $(l - 1)$ st elimination ideal of  $I_1$ . Furthermore,  $\mathbf{V}(I_1)$  is irreducible by (1). Thus, our induction hypothesis, applied to  $W_1 \subsetneq \mathbf{V}(I_1)$ , implies that there is  $W_l \subsetneq \mathbf{V}(I_l)$  such that

$$\mathbf{V}(I_l) - W_l \subset \tilde{\pi}_{l-1}(\mathbf{V}(I_1) - W_1),$$

where  $\tilde{\pi}_{l-1} : k^{n-1} \rightarrow k^{n-l}$  is projection onto the last  $(n-1) - (l-1) = n-l$  components. However, since  $\pi_l = \tilde{\pi}_{l-1} \circ \pi_1$  (see Exercise 4), it follows that

$$\mathbf{V}(I_l) - W_l \subset \tilde{\pi}_{l-1}(\mathbf{V}(I_1) - W_1) \subset \tilde{\pi}_{l-1}(\pi_l(V - W_0)) = \pi_l(V - W_0).$$

This completes the proof of (2), so that Theorem 1 is true for all irreducible varieties.

We can now prove the general case of the theorem. Given an arbitrary variety  $V \subset k^n$ , we can write  $V$  as a union of irreducible components (Theorem 2 of Chapter 4, §6):

$$V = V_1 \cup \cdots \cup V_m.$$

Let  $V'_i$  be the Zariski closure of  $\pi_l(V_i) \subset k^{n-l}$ . We claim that

$$(8) \quad \mathbf{V}(I_l) = V'_1 \cup \cdots \cup V'_m.$$

To prove this, observe that  $V'_1 \cup \cdots \cup V'_m$  is a variety containing  $\pi_l(V_1) \cup \cdots \cup \pi_l(V_m) = \pi_l(V)$ . Since  $\mathbf{V}(I_l)$  is the Zariski closure of  $\pi_l(V)$ , it follows that  $\mathbf{V}(I_l) \subset V'_1 \cup \cdots \cup V'_m$ . For the opposite inclusion, note that for each  $i$ , we have  $\pi_l(V_i) \subset \pi_l(V) \subset \mathbf{V}(I_l)$ , which implies  $V'_i \subset \mathbf{V}(I_l)$  since  $V'_i$  is the Zariski closure of  $\pi_l(V_i)$ . From here, (8) follows easily.

From (1), we know each  $V'_i$  is irreducible, so that (8) gives a decomposition of  $\mathbf{V}(I_l)$  into irreducibles. This need not be a minimal decomposition, and in fact  $V'_i = V'_j$  can occur when  $i \neq j$ . But we can find at least one of them not strictly contained in the others. By relabeling, we can assume  $V'_1 = \cdots = V'_r$  and  $V'_1 \not\subset V'_i$  for  $r+1 \leq i \leq m$ .

Applying (2) to the irreducible varieties  $V_1, \dots, V_r$  (with  $W_0 = \emptyset$ ), there are varieties  $W_i \subsetneq V'_i$  such that

$$V'_i - W_i \subset \pi_l(V_i), \quad 1 \leq i \leq r$$

since  $V'_i$  is the Zariski closure of  $\pi_l(V_i)$ . If we let  $W = W_1 \cup \cdots \cup W_r \cup V'_{r+1} \cup \cdots \cup V'_m$ , then  $W \subset \mathbf{V}(I_l)$ , and one sees easily that

$$\begin{aligned} \mathbf{V}(I_l) - W &= V'_1 \cup \cdots \cup V'_m - (W_1 \cup \cdots \cup W_r \cup V'_{r+1} \cup \cdots \cup V'_m) \\ &\subset (V'_1 - W_1) \cup \cdots \cup (V'_r - W_r) \\ &\subset \pi_l(V_1) \cup \cdots \cup \pi_l(V_r) \subset \pi_l(V). \end{aligned}$$

It remains to show that  $W \neq \mathbf{V}(I_l)$ . But if  $W$  were equal to  $\mathbf{V}(I_l)$ , then we would have  $V'_1 \subset W_1 \cup \cdots \cup W_r \cup V'_{r+1} \cup \cdots \cup V'_m$ . Since  $V'_1$  is irreducible, Exercise 5 below shows that  $V'_1$  would lie in one of  $W_1, \dots, W_r, V'_{r+1}, \dots, V'_m$ . This is impossible by the way we chose  $V'_1$  and  $W_1$ . Hence, we have a contradiction, and the theorem is proved.  $\square$

We can use the Closure Theorem to give a precise description of  $\pi_l(V)$  as follows.

**Corollary 2.** *Let  $k$  be algebraically closed, and let  $V \subset k^n$  be an affine variety. Then there are affine varieties  $Z_i \subset W_i \subset k^{n-l}$  for  $1 \leq i \leq p$  such that*

$$\pi_l(V) = \bigcup_{i=1}^p (W_i - Z_i).$$

**Proof.** If  $V = \emptyset$ , then we are done. Otherwise let  $W_1 = \mathbf{V}(I_l)$ . By the Closure Theorem, there is a variety  $Z_1 \subsetneq W_1$  such that  $W_1 - Z_1 \subset \pi_l(V)$ . Then, back in  $k^n$ , consider the set

$$V_1 = V \cap \{(a_1, \dots, a_n) \in k^n : (a_{l+1}, \dots, a_n) \in Z_1\}$$

One easily checks that  $V_1$  is an affine variety (see Exercise 7), and furthermore,  $V_1 \subsetneq V$  since otherwise we would have  $\pi_l(V) \subset Z_1$ , which would imply  $W_1 \subset Z_1$  by Zariski closure. Moreover, one can check that

$$(9) \quad \pi_l(V) = (W_1 - Z_1) \cup \pi_l(V_1)$$

(see Exercise 7).

If  $V_1 = \emptyset$ , then we are done. If  $V_1$  is nonempty, let  $W_2$  be the Zariski closure of  $\pi_l(V_1)$ . Applying the Closure Theorem to  $V_1$ , we get  $Z_2 \subsetneq W_2$  with  $W_2 - Z_2 \subset \pi_l(V_1)$ . Then, repeating the above construction, we get the variety

$$V_2 = V_1 \cap \{(a_1, \dots, a_n) \in k^n : (a_{l+1}, \dots, a_n) \in Z_2\}$$

such that  $V_2 \subsetneq V_1$  and

$$\pi_l(V) = (W_1 - Z_1) \cup (W_2 - Z_2) \cup \pi_l(V_2).$$

If  $V_2 = \emptyset$ , we are done, if not, we repeat this process again to obtain  $W_3, Z_3$  and  $V_3 \subsetneq V_2$ . Continuing in this way, we must eventually have  $V_N = \emptyset$  for some  $N$ , since otherwise we would get an infinite descending chain of varieties

$$V \supsetneq V_1 \supsetneq V_2 \supsetneq \dots,$$

which would contradict Proposition 1 of Chapter 4, §6. Once we have  $V_N = \emptyset$ , the desired formula for  $\pi_l(V)$  follows easily.  $\square$

In general, a set of the form described in Corollary 2 is called *constructible*.

### EXERCISES FOR §6

1. This exercise is concerned with (1) in the proof of Theorem 1.
  - a. Prove that  $I$  prime implies  $I_l$  prime. Your proof should work for any field  $k$ .
  - b. In the text, we showed  $V$  irreducible implies  $\mathbf{V}(I_l)$  irreducible when the field is algebraically closed. Give an argument that works over any field  $k$ .
2. Let  $g, h \in k[x_1, \dots, x_n]$ , and assume that  $h$  has positive degree  $r$  in  $x_1$ , so that  $h = \sum_{i=0}^r u_i(x_2, \dots, x_n)x_1^i$ . Use induction on the degree of  $g$  in  $x_1$  to show that there is some integer  $N$  such that  $u_r^N g = qh + g'$  where  $q, g' \in k[x_1, \dots, x_n]$  and  $g'$  has degree  $< r$  in  $x_1$ .
3. In this exercise, we will study the geometric meaning of the two cases encountered in the proof of Theorem 1. For concreteness, let us assume that  $k = \mathbb{C}$ . Recall that we have  $V \subset \mathbb{C}^n$  irreducible and the projection  $\pi_1 : \mathbb{C}^n \rightarrow \mathbb{C}^{n-1}$ . Given a point  $y \in \mathbb{C}^{n-1}$ , let

$$V_y = \{x \in V : \pi_1(x) = y\}.$$

We call  $V_y$  the *fiber over  $y$*  of the projection  $\pi_1$ .

- a. Prove that  $V_y \subset \mathbb{C} \times \{y\}$ , and that  $V_y \neq \emptyset$  if and only if  $y \in \pi_1(V)$ .
- b. Show that in Case I of the proof of Theorem 1,  $\pi_1(V) = \mathbf{V}(I_1)$  and  $V_y = \mathbb{C} \times \{y\}$  for all  $y \in \pi_1(V)$ . Thus, this case means that all nonempty fibers are as big as possible.



- c. Show that in Case II, there is a variety  $\tilde{W} \subset \mathbb{C}^{n-1}$  such that  $\pi_1(V) \not\subset \tilde{W}$  and every non-empty fiber not over a point of  $\tilde{W}$  is finite. Thus, this case means that “most” nonempty fibers are finite. Hint: If  $h$  is as in (3) and  $u_r \notin I_1$ , then let  $\tilde{W} = \mathbf{V}(u_r)$ .
  - d. If  $V = \mathbf{V}(x_2 - x_1x_3) \subset \mathbb{C}^3$ , then show that “most” fibers  $V_y$  consist of a single point. Is there a fiber which is infinite?
4. Given  $\pi_1 : k^n \rightarrow k^{n-1}, \pi_l : k^n \rightarrow k^{n-l}$  and  $\tilde{\pi}_{l-1} : k^{n-1} \rightarrow k^{n-l}$  as in the proof of Theorem 1, show that  $\pi_l = \tilde{\pi}_{l-1} \circ \pi_1$ .
  5. Let  $V \subset k^n$  be an irreducible variety. Then prove the following assertions.
    - a. If  $V_1, V_2 \subset k^n$  are varieties such that  $V \subset V_1 \cup V_2$ , then either  $V \subset V_1$  or  $V \subset V_2$ .
    - b. More generally, if  $V_1, \dots, V_m \subset k^n$  are varieties such that  $V \subset V_1 \cup \dots \cup V_m$ , then  $V \subset V_i$  for some  $i$ .
  6. In the proof of Theorem 1, the variety  $W \subset \mathbf{V}(I_l)$  we constructed was rather large—it contained all but one of the irreducible components of  $\mathbf{V}(I_l)$ . Show that we can do better by proving that there is a variety  $W \subset \mathbf{V}(V_l)$  which contains no irreducible component of  $\mathbf{V}(I_l)$  and satisfies  $\mathbf{V}(I_l) - W \subset \pi_l(V)$ . Hint: First, explain why each irreducible component of  $\mathbf{V}(I_l)$  is  $V'_j$  for some  $j$ . Then apply the construction we did for  $V'_1$  to each of these  $V'_j$ 's.
  7. This exercise is concerned with the proof of Corollary 2.
    - a. Verify that  $V_1 = V \cap \{(a_1, \dots, a_n) \in k^n : (a_{l+1}, \dots, a_n) \in Z_1\}$  is an affine variety.
    - b. Verify that  $\pi_l(V) = (W_1 - Z_1) \cup \pi_l(V_1)$ .
  8. Let  $V = \mathbf{V}(y - xz) \subset \mathbb{C}^3$ . Corollary 2 tells us that  $\pi_1(V) \subset \mathbb{C}^2$  is a constructible set. Find an explicit decomposition of  $\pi_1(V)$  of the form given by Corollary 2. Hint: Your answer will involve  $W_1, Z_1$  and  $W_2$ .
  9. When dealing with affine varieties, it is sometimes helpful to use the *minimum principle*, which states that among any collection of varieties in  $k^n$ , there is a variety which is minimal with respect to inclusion. More precisely, this means that if we are given varieties  $V_\alpha, \alpha \in \mathcal{A}$ , where  $\mathcal{A}$  is any index set, then there is some  $\beta \in \mathcal{A}$  with the property that for any  $\alpha \in \mathcal{A}, V_\alpha \subset V_\beta$  implies  $V_\alpha = V_\beta$ .
    - a. Prove the minimum principle. Hint: Use Proposition 1 of Chapter 4, §6.
    - b. Formulate and prove an analogous *maximum principle* for ideals in  $k[x_1, \dots, x_n]$ .
  10. As an example of how to use the minimum principle of Exercise 9, we will give a different proof of Corollary 2. Namely, consider the collection of all varieties  $V \subset k^n$  for which  $\pi_l(V)$  is not constructible. By the minimum principle, we can find a variety  $V$  such that  $\pi_l(V)$  is not constructible but  $\pi_l(W)$  is constructible for every variety  $W \subsetneq V$ . Show how the proof of Corollary 2 up to (9) can be used to obtain a contradiction and thereby prove the corollary.
  11. In this exercise, we will generalize Corollary 2 to show that if  $k$  is algebraically closed, then  $\pi_l(C)$  is constructible whenever  $C$  is any constructible subset of  $k^n$ .
    - a. Show that it suffices to show that  $\pi_l(V - W)$  is constructible whenever  $V$  is an irreducible variety in  $k^n$  and  $W \subsetneq V$ .
    - b. If  $V$  is irreducible and  $W_1$  is the Zariski closure of  $\pi_l(V)$ , then (2) implies we can find a variety  $Z_1 \subsetneq W_1$  such that  $W_1 - Z_1 \subset \pi_l(V - W)$ . If we set  $V_1 = \{x \in V : \pi_l(x) \in Z_1\}$  then prove that  $V_1 \neq V$  and  $\pi_l(V - W) = (W_1 - Z_1) \cup \pi_l(V_1 - W)$ .
    - c. Now use the minimum principle as in Exercise 10 to complete the proof.

# 6

## Robotics and Automatic Geometric Theorem Proving

In this chapter we will consider two recent applications of concepts and techniques from algebraic geometry in areas of computer science. First, continuing a theme introduced in several examples in Chapter 1, we will develop a systematic approach that uses algebraic varieties to describe the space of possible configurations of mechanical linkages such as robot “arms.” We will use this approach to solve the forward and inverse kinematic problems of robotics for certain types of robots.

Second, we will apply the algorithms developed in earlier chapters to the study of automatic geometric theorem proving, an area that has been of interest to researchers in artificial intelligence. When the hypotheses of a geometric theorem can be expressed as polynomial equations relating the cartesian coordinates of points in the Euclidean plane, the geometrical propositions deducible from the hypotheses will include all the statements that can be expressed as polynomials in the ideal generated by the hypotheses.

### §1 Geometric Description of Robots

To treat the space of configurations of a robot geometrically, we need to make some simplifying assumptions about the components of our robots and their mechanical properties. We will not try to address many important issues in the engineering of actual robots (such as what types of motors and mechanical linkages would be used to achieve what motions, and how those motions would be controlled). Thus, we will restrict ourselves to highly idealized robots. However, within this framework, we will be able to indicate the types of problems that actually arise in robot motion description and planning.

We will always consider robots constructed from rigid links or segments, connected by joints of various types. For simplicity, we will consider only robots in which the segments are connected *in series*, as in a human limb. One end of our robot “arm” will usually be fixed in position. At the other end will be the “hand” or “effector,” which will sometimes be considered as a final segment of the robot. In actual robots, this “hand” might be provided with mechanisms for grasping objects or with tools for performing some task. Thus, one of the major goals is to be able to describe and specify the position and orientation of the “hand.”

Since the segments of our robots are rigid, the possible motions of the entire robot assembly are determined by the motions of the joints. Many actual robots are constructed using

- planar revolute joints, and
- prismatic joints.

A planar revolute joint permits a *rotation* of one segment relative to another. We will assume that both of the segments in question lie in one plane and all motions of the joint will leave the two segments in that plane. (This is the same as saying that the axis of rotation is perpendicular to the plane in question.)

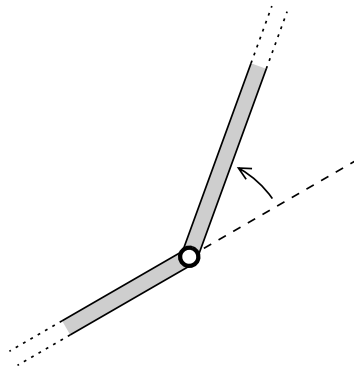

a revolute joint

A prismatic joint permits one segment of a robot to move by sliding or *translation* along an axis. The following sketch shows a schematic view of a prismatic joint between two segments of a robot lying in a plane. Such a joint permits translational motion along a line in the plane.

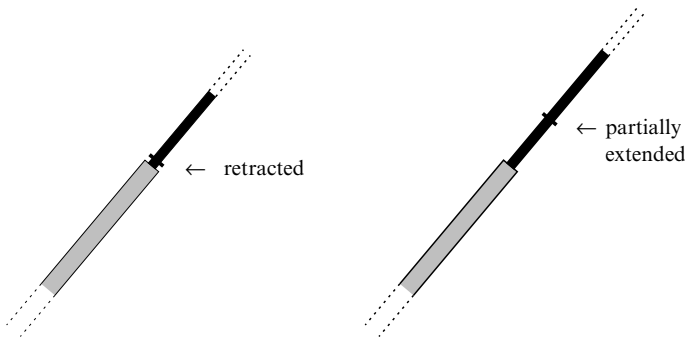

a prismatic joint

If there are several joints in a robot, we will assume for simplicity that the joints all lie in the same plane, that the axes of rotation of all revolute joints are perpendicular to that plane, and, in addition, that the translation axes for the prismatic joints all lie

in the plane of the joints. Thus, all motion will take place in one plane. Of course, this leads to a very restricted class of robots. Real robots must usually be capable of 3-dimensional motion. To achieve this, other types and combinations of joints are used. These include “ball” joints allowing rotation about any axis passing through some point in  $\mathbb{R}^3$  and helical or “screw” joints combining rotation and translation along the axis of rotation in  $\mathbb{R}^3$ . It would also be possible to connect several segments of a robot with planar revolute joints, but with *nonparallel* axes of rotation. All of these possible configurations can be treated by methods similar to the ones we will present, but we will not consider them in detail. Our purpose here is to illustrate how affine varieties can be used to describe the geometry of robots, not to present a treatise on practical robotics. The planar robots provide a class of relatively uncomplicated but illustrative examples for us to consider.

**Example 1.** Consider the following planar robot “arm” with three revolute joints and one prismatic joint. All motions of the robot take place in the plane of the paper.

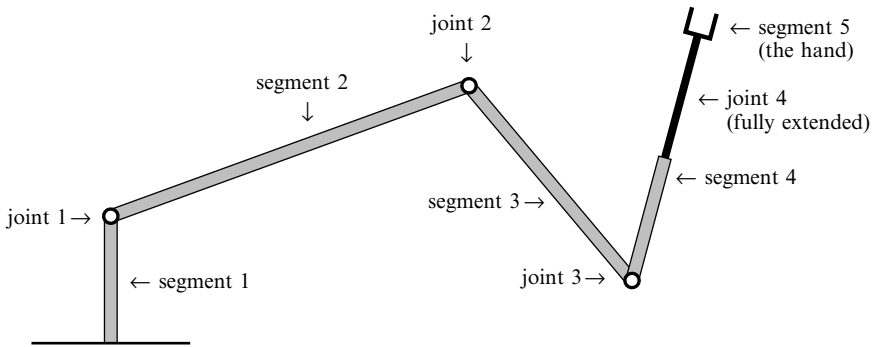

For easy reference, we number the segments and joints of a robot in increasing order out from the fixed end to the hand. Thus, in the above figure, segment 2 connects joints 1 and 2, and so on. Joint 4 is prismatic, and we will regard segment 4 as having variable length, depending on the setting of the prismatic joint. In this robot, the hand of the robot comprises segment 5.

In general, the position or setting of a revolute joint between segments  $i$  and  $i + 1$  can be described by measuring the angle  $\theta$  (counterclockwise) from segment  $i$  to segment  $i + 1$ . Thus, the totality of settings of such a joint can be parametrized by a circle  $S^1$  or by the interval  $[0, 2\pi]$  with the endpoints identified. (In some cases, a revolute joint may not be free to rotate through a full circle, and then we would parametrize the possible settings by a subset of  $S^1$ .)

Similarly, the setting of a prismatic joint can be specified by giving the distance the joint is extended or, as in Example 1, by the total length of the segment (i.e., the distance between the end of the joint and the previous joint). Either way, the settings of a prismatic joint can be parametrized by a finite interval of real numbers.

If the joint settings of our robot can be specified independently, then the possible settings of the whole collection of joints in a planar robot with  $r$  revolute joints and  $p$  prismatic joints can be parametrized by the Cartesian product

$$\mathcal{J} = S^1 \times \cdots \times S^1 \times I_1 \times \cdots \times I_p,$$

where there is one  $S^1$  factor for each revolute joint, and  $I_j$  gives the settings of the  $j$ th prismatic joint. We will call  $\mathcal{J}$  the *joint space* of the robot.

We can describe the space of possible configurations of the “hand” of a planar robot as follows. Fixing a Cartesian coordinate system in the plane, we can represent the possible positions of the “hand” by the points  $(a, b)$  of a region  $U \subset \mathbb{R}^2$ . Similarly, we can represent the orientation of the “hand” by giving a unit vector aligned with some specific feature of the hand. Thus, the possible hand orientations are parametrized by vectors  $\mathbf{u}$  in  $V = S^1$ . For example, if the “hand” is attached to a revolute joint, then we have the following picture of the hand configuration:

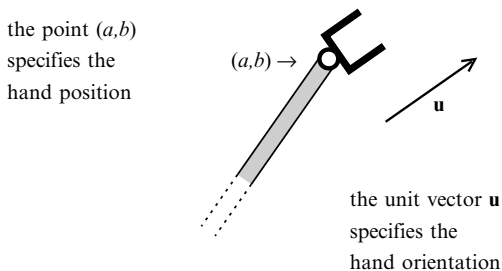

We will call  $C = U \times V$  the *configuration space* or *operational space* of the robot’s “hand.”

Since the robot’s segments are assumed to be rigid, each collection of joint settings will place the “hand” in a uniquely determined location, with a uniquely determined orientation. Thus, we have a function or mapping

$$f : \mathcal{J} \rightarrow C$$

which encodes how the different possible joint settings yield different hand configurations.

The two basic problems we will consider can be described succinctly in terms of the mapping  $f : \mathcal{J} \rightarrow C$  described above:

- (Forward Kinematic Problem) Can we give an explicit description or formula for  $f$  in terms of the joint settings (our coordinates on  $\mathcal{J}$ ) and the dimensions of the segments of the robot “arm”?
- (Inverse Kinematic Problem) Given  $c \in C$ , can we determine one or all the  $j \in \mathcal{J}$  such that  $f(j) = c$ ?

In §2, we will see that the forward problem is relatively easily solved. Determining the position and orientation of the “hand” from the “arm” joint settings is mainly a matter of being systematic in describing the relative positions of the segments on either

side of a joint. Thus, the forward problem is of interest mainly as a preliminary to the inverse problem. We will show that the mapping  $f : \mathcal{J} \rightarrow \mathcal{C}$  giving the “hand” configuration as a function of the joint settings may be written as a polynomial mapping as in Chapter 5, §1.

The inverse problem is somewhat more subtle since our explicit formulas will not be linear if revolute joints are present. Thus, we will need to use the general results on systems of polynomial equations to solve the equation

$$(1) \quad f(j) = c.$$

One feature of nonlinear systems of equations is that there can be several different solutions, even when the entire set of solutions is finite. We will see in §3 that this is true for a planar robot arm with three (or more) revolute joints. As a practical matter, the potential nonuniqueness of the solutions of the systems (1) is sometimes very desirable. For instance, if our real world robot is to work in a space containing physical obstacles or barriers to movement in certain directions, it may be the case that some of the solutions of (1) for a given  $c \in \mathcal{C}$  correspond to positions that are not physically reachable:

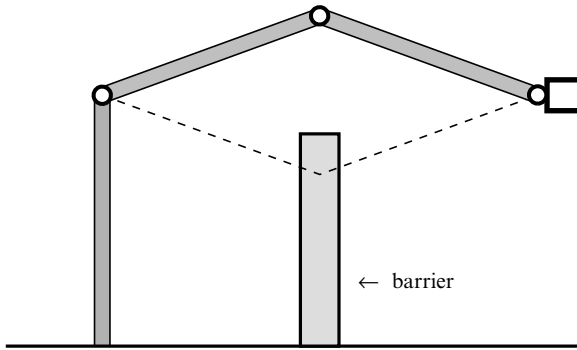

To determine whether it is possible to reach a given position, we might need to determine *all* solutions of (1), then see which one(s) are feasible given the constraints of the environment in which our robot is to work.

**EXERCISES FOR §1**

1. Give descriptions of the joint space  $\mathcal{J}$  and the configuration space  $\mathcal{C}$  for the planar robot picture in Example 1 in the text. For your description of  $\mathcal{C}$ , determine a bounded subset of  $U \subset \mathbb{R}^2$  containing all possible hand positions. Hint: The description of  $U$  will depend on the lengths of the segments.
2. Consider the mapping  $f : \mathcal{J} \rightarrow \mathcal{C}$  for the robot pictured in Example 1 in the text. On geometric grounds, do you expect  $f$  to be a *one-to-one* mapping? Can you find two different ways to put the hand in some particular position with a given orientation? Are there more than two such positions?

The text discussed the joint space  $\mathcal{J}$  and the configuration space  $\mathcal{C}$  for planar robots. In the following problems, we consider what  $\mathcal{J}$  and  $\mathcal{C}$  look like for robots capable of motion in three dimensions.

3. What would the configuration space  $\mathcal{C}$  look like for a 3-dimensional robot? In particular, how can we describe the possible hand orientations?
4. A “ball” joint at point  $B$  allows segment 2 in the robot pictured below to rotate by any angle about any axis in  $\mathbb{R}^3$  passing through  $B$ . (Note: The motions of this joint are similar to those of the “joystick” found in some computer games.)

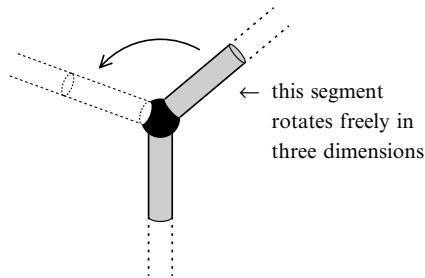

a ball joint

- a. Describe the set of possible joint settings for this joint mathematically. Hint: The distinct joint settings correspond to the possible direction vectors of segment 2.
- b. Construct a one-to-one correspondence between your set of joint settings in part (a) and the unit sphere  $S^2 \subset \mathbb{R}^3$ . Hint: One simple way to do this is to use the spherical angular coordinates  $\phi, \theta$  on  $S^2$ .
5. A helical or “screw” joint at point  $H$  allows segment 2 of the robot pictured below to extend out from  $H$  along the the line  $L$  in the direction of segment 1, while rotating about the axis  $L$ .

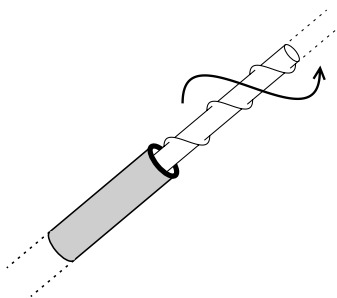

a helical or “screw” joint

The rotation angle  $\theta$  (measured from the original, unextended position of segment 2) is given by  $\theta = l \cdot \alpha$ , where  $l \in [0, m]$  gives the distance from  $H$  to the other end of segment 2 and

$\alpha$  is a constant angle. Give a mathematical description of the space of joint settings for this joint.

6. Give a mathematical description of the joint space  $\mathcal{J}$  for a 3-dimensional robot with two “ball” joints and one helical joint.

## §2 The Forward Kinematic Problem

In this section, we will present a standard method for solving the forward kinematic problem for a given robot “arm.” As in §1, we will only consider robots in  $\mathbb{R}^2$ , which means that the “hand” will be constrained to lie in the plane. Other cases will be studied in the exercises.

All of our robots will have a first segment that is anchored, or fixed in position. In other words, there is no movable joint at the initial endpoint of segment 1. With this convention, we will use a standard rectangular coordinate system in the plane to describe the position and orientation of the “hand.” The origin of this coordinate system is placed at joint 1 of the robot arm, which is also fixed in position since all of segment 1 is. For example:

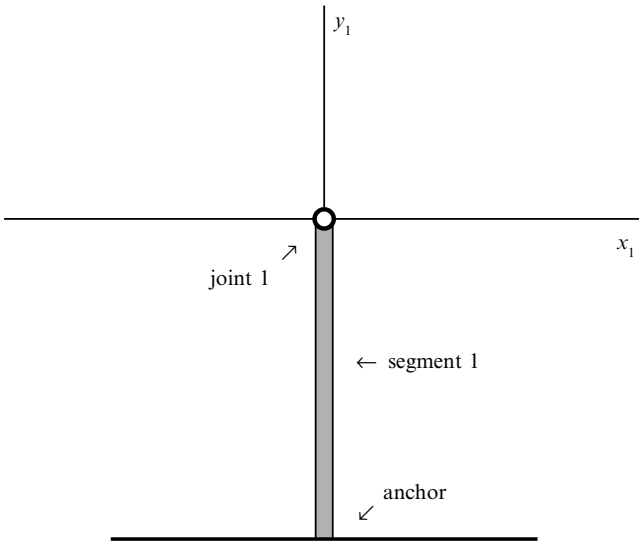

The Global  $(x_1, y_1)$  Coordinate System

In addition to the global  $(x_1, y_1)$  coordinate system, we introduce a local rectangular coordinate system at each of the *revolute joints* to describe the relative positions of the segments meeting at that joint. Naturally, these coordinate systems will *change* as the position of the “arm” varies.

At a revolute joint  $i$ , we introduce an  $(x_{i+1}, y_{i+1})$  coordinate system in the following way. The origin is placed at joint  $i$ . We take the positive  $x_{i+1}$ -axis to lie along the



direction of segment  $i + 1$  (in the robot's current position). Then the positive  $y_{i+1}$ -axis is determined to form a normal right-handed rectangular coordinate system. Note that for each  $i \geq 2$ , the  $(x_i, y_i)$  coordinates of joint  $i$  are  $(l_i, 0)$ , where  $l_i$  is the length of segment  $i$ .

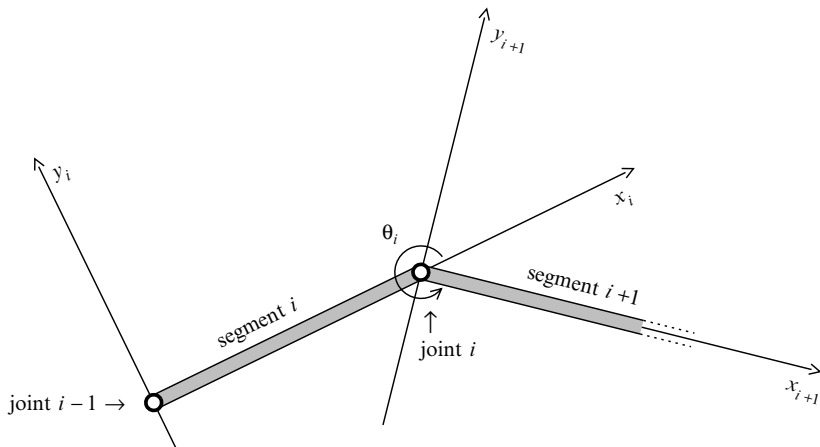

Our first goal is to relate the  $(x_{i+1}, y_{i+1})$  coordinates of a point with the  $(x_i, y_i)$  coordinates of that point. Let  $\theta_i$  be the counterclockwise angle from the  $x_i$ -axis to the  $x_{i+1}$ -axis. This is the same as the joint setting angle  $\theta_i$  described in §1. From the diagram above, we see that if a point  $q$  has  $(x_{i+1}, y_{i+1})$  coordinates

$$q = (a_{i+1}, b_{i+1}),$$

then to obtain the  $(x_i, y_i)$  coordinates of  $q$ , say

$$q = (a_i, b_i),$$

we rotate by the angle  $\theta_i$  (to align the  $x_i$ - and  $x_{i+1}$ -axes), and then translate by the vector  $(l_i, 0)$  (to make the origins of the coordinate systems coincide). In the exercises, you will show that rotation by  $\theta_i$  is accomplished by multiplying by the rotation matrix

$$\begin{pmatrix} \cos \theta_i & -\sin \theta_i \\ \sin \theta_i & \cos \theta_i \end{pmatrix}.$$

It is also easy to check that translation is accomplished by adding the vector  $(l_i, 0)$ . Thus, we get the following relation between the  $(x_i, y_i)$  and  $(x_{i+1}, y_{i+1})$  coordinates of  $q$ :

$$\begin{pmatrix} a_i \\ b_i \end{pmatrix} = \begin{pmatrix} \cos \theta_i & -\sin \theta_i \\ \sin \theta_i & \cos \theta_i \end{pmatrix} \cdot \begin{pmatrix} a_{i+1} \\ b_{i+1} \end{pmatrix} + \begin{pmatrix} l_i \\ 0 \end{pmatrix}.$$

This coordinate transformation is also commonly written in a shorthand form using a

$3 \times 3$  matrix and 3-component vectors:

$$(1) \quad \begin{pmatrix} a_i \\ b_i \\ 1 \end{pmatrix} = \begin{pmatrix} \cos \theta_i & -\sin \theta_i & l_i \\ \sin \theta_i & \cos \theta_i & 0 \\ 0 & 0 & 1 \end{pmatrix} \cdot \begin{pmatrix} a_{i+1} \\ b_{i+1} \\ 1 \end{pmatrix} = A_i \cdot \begin{pmatrix} a_{i+1} \\ b_{i+1} \\ 1 \end{pmatrix}.$$

This allows us to combine the rotation by  $\theta_i$  with the translation along segment  $i$  into a single  $3 \times 3$  matrix  $A_i$ .

**Example 1.** With this notation in hand, let us next consider a general plane robot “arm” with three revolute joints:

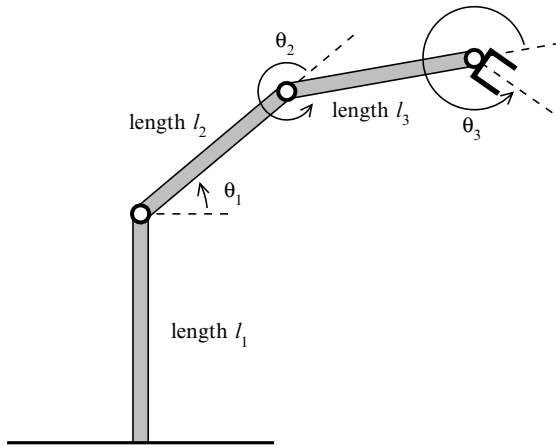

We will think of the hand as segment 4, which is attached via the revolute joint 3 to segment 3. As before,  $l_i$  will denote the length of segment  $i$ . We have

$$A_1 = \begin{pmatrix} \cos \theta_1 & -\sin \theta_1 & 0 \\ \sin \theta_1 & \cos \theta_1 & 0 \\ 0 & 0 & 1 \end{pmatrix}$$

since the origin of the  $(x_2, y_2)$  coordinate system is also placed at joint 1. We also have matrices  $A_2$  and  $A_3$  as in formula (1). The key observation is that the global coordinates of any point can be obtained by starting in the  $(x_4, y_4)$  coordinate system and working our way back to the global  $(x_1, y_1)$  system one joint at a time. That is, we multiply the  $(x_4, y_4)$  coordinate vector of the point  $A_3, A_2, A_1$  in turn:

$$\begin{pmatrix} x_1 \\ y_1 \\ 1 \end{pmatrix} = A_1 A_2 A_3 \begin{pmatrix} x_4 \\ y_4 \\ 1 \end{pmatrix}.$$

Using the trigonometric addition formulas, this equation can be written as

$$\begin{pmatrix} x_1 \\ y_1 \\ 1 \end{pmatrix} = \begin{pmatrix} \cos(\theta_1 + \theta_2 + \theta_3) & -\sin(\theta_1 + \theta_2 + \theta_3) & l_3 \cos(\theta_1 + \theta_2) + l_2 \cos \theta_1 \\ \sin(\theta_1 + \theta_2 + \theta_3) & \cos(\theta_1 + \theta_2 + \theta_3) & l_3 \sin(\theta_1 + \theta_2) + l_2 \sin \theta_1 \\ 0 & 0 & 1 \end{pmatrix} \begin{pmatrix} x_4 \\ y_4 \\ 1 \end{pmatrix}.$$

Since the  $(x_4, y_4)$  coordinates of the hand are  $(0, 0)$  (because the hand is attached directly to joint 3), we obtain the  $(x_1, y_1)$  coordinates of the hand by setting  $x_4 = y_4 = 0$  and computing the matrix product above. The result is

$$(2) \quad \begin{pmatrix} x_1 \\ y_1 \\ 1 \end{pmatrix} = \begin{pmatrix} l_3 \cos(\theta_1 + \theta_2) + l_2 \cos \theta_1 \\ l_3 \sin(\theta_1 + \theta_2) + l_2 \sin \theta_1 \\ 1 \end{pmatrix}.$$

The hand orientation is determined if we know the angle between the  $x_4$ -axis and the direction of any particular feature of interest to us on the hand. For instance, we might simply want to use the direction of the  $x_4$ -axis to specify this orientation. From our computations, we know that the angle between the  $x_1$ -axis and the  $x_4$ -axis is simply  $\theta_1 + \theta_2 + \theta_3$ . Knowing the  $\theta_i$  allows us to also compute this angle.

If we combine this fact about the hand orientation with the formula (2) for the hand position, we get an explicit description of the mapping  $f : \mathcal{J} \rightarrow \mathcal{C}$  introduced in §1. As a function of the joint angles  $\theta_i$ , the configuration of the hand is given by

$$(3) \quad f(\theta_1 + \theta_2 + \theta_3) = \begin{pmatrix} l_3 \cos(\theta_1 + \theta_2) + l_2 \cos \theta_1 \\ l_3 \sin(\theta_1 + \theta_2) + l_2 \sin \theta_1 \\ \theta_1 + \theta_2 + \theta_3 \end{pmatrix}.$$

The same ideas will apply when any number of planar revolute joints are present. You will study the explicit form of the function  $f$  in these cases in Exercise 7.

**Example 2.** Prismatic joints can also be handled within this framework. For instance, let us consider a planar robot whose first three segments and joints are the same as those of the robot in Example 1, but which has an additional prismatic joint between segment 4 and the hand. Thus, segment 4 will have variable length and segment 5 will be the hand.

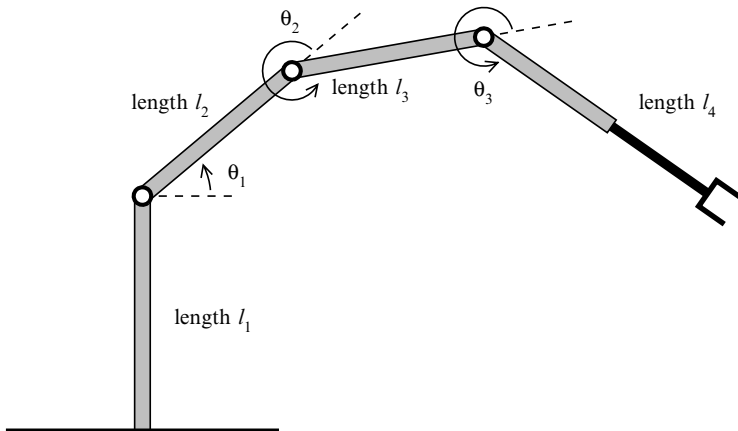

The translation axis of the prismatic joint lies along the direction of segment 4. We can describe such a robot as follows. The three revolute joints allow us exactly the same freedom in placing joint 3 as in the robot studied in Example 1. However, the prismatic joint allows us to change the length of segment 4 to any value between  $l_4 = m_1$  (when retracted) and  $l_4 = m_2$  (when fully extended). By the reasoning given in Example 1, if the setting  $l_4$  of the prismatic joint is known, then the position of the hand will be given by multiplying the product matrix  $A_1 A_2 A_3$  times the  $(x_4, y_4)$  coordinate vector of the hand, namely  $(l_4, 0)$ . It follows that the configuration of the hand is given by

$$(4) \quad g(\theta_1, \theta_2, \theta_3, l_4) = \begin{pmatrix} l_4 \cos(\theta_1 + \theta_2 + \theta_3) + l_3 \cos(\theta_1 + \theta_2) + l_2 \cos \theta_1 \\ l_4 \sin(\theta_1 + \theta_2 + \theta_3) + l_3 \sin(\theta_1 + \theta_2) + l_2 \sin \theta_1 \\ \theta_1 + \theta_2 + \theta_3 \end{pmatrix}.$$

As before,  $l_2$  and  $l_3$  are constant, but  $l_4 \in [m_1, m_2]$  is now another variable. The hand orientation will be given by  $\theta_1 + \theta_2 + \theta_3$  as before since the setting of the prismatic joint will not affect the direction of the hand.

We will next discuss how formulas such as (3) and (4) may be converted into representations of  $f$  and  $g$  as polynomial or rational mappings in suitable variables. The joint variables for revolute and for prismatic joints are handled differently. For the revolute joints, the most direct way of converting to a polynomial set of equations is to use an idea we have seen several times before, for example, in Exercise 8 of Chapter 2, §8. Even though  $\cos \theta$  and  $\sin \theta$  are transcendental functions, they give a parametrization

$$\begin{aligned} x &= \cos \theta, \\ y &= \sin \theta \end{aligned}$$

of the algebraic variety  $\mathbf{V}(x^2 + y^2 - 1)$  in the plane. Thus, we can write the components of the right-hand side of (3) or, equivalently, the entries of the matrix  $A_1 A_2 A_3$  in (2) as functions of

$$\begin{aligned} c_i &= \cos \theta_i, \\ s_i &= \sin \theta_i, \end{aligned}$$

subject to the constraints

$$(5) \quad c_i^2 + s_i^2 - 1 = 0$$

for  $i = 1, 2, 3$ . Note that the variety defined by these three equations in  $\mathbb{R}^6$  is a concrete realization of the joint space  $\mathcal{J}$  for this type of robot. Geometrically, this variety is just a Cartesian product of three copies of the circle.

Explicitly, we obtain from (3) an expression for the hand position as a function of the variables  $c_1, s_1, c_2, s_2, c_3, s_3$ . Using the trigonometric addition formulas, we can write

$$\cos(\theta_1 + \theta_2) = \cos \theta_1 \cos \theta_2 - \sin \theta_1 \sin \theta_2 = c_1 c_2 - s_1 s_2.$$

Similarly,

$$\sin(\theta_1 + \theta_2) = \sin \theta_1 \cos \theta_2 + \sin \theta_2 \cos \theta_1 = s_1 c_2 + s_2 c_1.$$

Thus, the  $(x_1, y_1)$  coordinates of the hand position are:

$$(6) \quad \begin{pmatrix} l_3(c_1c_2 - s_1s_2) + l_2c_1 \\ l_3(s_1c_2 + s_2c_1) + l_2s_1 \end{pmatrix}.$$

In the language of Chapter 5, we have defined a polynomial mapping from the variety  $\mathcal{J} = \mathbf{V}(x_1^2 + y_1^2 - 1, x_2^2 + y_2^2 - 1, x_3^2 + y_3^2 - 1)$  to  $\mathbb{R}^2$ . Note that the hand *position* does not depend on  $\theta_3$ . That angle enters only in determining the hand orientation.

Since the hand orientation depends directly on the angles  $\theta_i$  themselves, it is *not* possible to express the orientation itself as a polynomial in  $c_i = \cos \theta_i$  and  $s_i = \sin \theta_i$ . However, we can handle the orientation in a similar way. See Exercise 3.

Similarly, from the mapping  $g$  in Example 2, we obtain the polynomial form

$$(7) \quad \begin{pmatrix} l_4(c_1(c_2c_3 - s_2s_3) - s_1(c_2s_3 + c_3s_2)) + l_3(c_1c_2 - s_1s_2) + l_2c_1 \\ l_4(s_1(c_2c_3 - s_2s_3) + c_1(c_2s_3 + c_3s_2)) + l_3(s_1c_2 + s_2c_1) + l_2s_1 \end{pmatrix}$$

for the  $(x_1, y_1)$  coordinates of the hand position. Here  $\mathcal{J}$  is the subset  $V \times [m_1, m_2]$  of the variety  $V \times \mathbb{R}$ , where  $V = \mathbf{V}(x_1^2 + y_1^2 - 1, x_2^2 + y_2^2 - 1, x_3^2 + y_3^2 - 1)$ . The length  $l_4$  is treated as another ordinary variable in (7), so our component functions are polynomials in  $l_4$ , and the  $c_i$  and  $s_i$ .

A second way to write formulas (3) and (4) is based on the *rational* parametrization

$$(8) \quad \begin{aligned} x &= \frac{1 - t^2}{1 + t^2}, \\ y &= \frac{2t}{1 + t^2} \end{aligned}$$

of the circle introduced in §3 of Chapter 1. [In terms of the trigonometric parametrization,  $t = \tan(\theta/2)$ .] This allows us to express the mapping (3) in terms of three variables  $t_i = \tan(\theta_i/2)$ . We will leave it as an exercise for the reader to work out this alternate explicit form of the mapping  $f : \mathcal{J} \rightarrow \mathcal{C}$  in Example 1. In the language of Chapter 5, the variety  $\mathcal{J}$  for the robot in Example 1 is birationally equivalent to  $\mathbb{R}^3$ . We can construct a rational parametrization  $\rho : \mathbb{R}^3 \rightarrow \mathcal{J}$  using three copies of the parametrization (8). Hence, we obtain a rational mapping from  $\mathbb{R}^3$  to  $\mathbb{R}^2$ , expressing the hand coordinates of the robot arm as functions of  $t_1, t_2, t_3$  by taking the composition of  $\rho$  with the hand coordinate mapping in the form (6).

Both of these forms have certain advantages and disadvantages for practical use. For the robot of Example 1, one immediately visible advantage of the rational mapping obtained from (8) is that it involves only three variables rather than the six variables  $s_i, c_i, i = 1, 2, 3$ , needed to describe the full mapping  $f$  as in Exercise 3. In addition, we do not need the three extra constraint equations (5). However, the  $t_i$  values corresponding to joint positions with  $\theta_i$  close to  $\pi$  are awkwardly large, and there is no  $t_i$  value corresponding to  $\theta_i = \pi$ . We do not obtain every theoretically possible hand position in the image of the mapping  $f$  when it is expressed in this form. Of course, this might not actually be a problem if our robot is constructed so that segment  $i + 1$  is not free to fold back onto segment  $i$  (that is, the joint setting  $\theta_i = \pi$  is not possible).

The polynomial form (6) is more unwieldy, but since it comes from the trigonometric (unit-speed) parametrization of the circle, it does not suffer from the potential shortcomings of the rational form. It would be somewhat better suited for revolute joints that can freely rotate through a full circle.

**EXERCISES FOR §2**

1. Consider the plane  $\mathbb{R}^2$  with an orthogonal right-handed coordinate system  $(x_1, y_1)$ . Now introduce a second coordinate system  $(x_2, y_2)$  by rotating the first counterclockwise by an angle  $\theta$ . Suppose that a point  $q$  has  $(x_1, y_1)$  coordinates  $(a_1, b_1)$  and  $(x_2, y_2)$  coordinates  $(a_2, b_2)$ . We claim that

$$\begin{pmatrix} a_1 \\ b_1 \end{pmatrix} = \begin{pmatrix} \cos \theta & -\sin \theta \\ \sin \theta & \cos \theta \end{pmatrix} \cdot \begin{pmatrix} a_2 \\ b_2 \end{pmatrix}.$$

To prove this, first express the  $(x_1, y_1)$  coordinates of  $q$  in polar form as

$$q = (a_1, b_1) = (r \cos \alpha, r \sin \alpha).$$

- a. Show that the  $(x_2, y_2)$  coordinates of  $q$  are given by

$$q = (a_2, b_2) = (r \cos(\alpha + \theta), r \sin(\alpha + \theta)).$$

- b. Now use trigonometric identities to prove the desired formula.
2. In Examples 1 and 2, we used a  $3 \times 3$  matrix  $A$  to represent each of the changes of coordinates from one local system to another. Those changes of coordinates were rotations, followed by translations. These are special types of *affine transformations*.
    - a. Show that any affine transformation in the plane

$$\begin{aligned} x' &= ax + by + e, \\ y' &= cx + dy + f \end{aligned}$$

can be represented in a similar way:

$$\begin{pmatrix} x' \\ y' \\ 1 \end{pmatrix} = \begin{pmatrix} a & b & e \\ c & d & f \\ 0 & 0 & 1 \end{pmatrix} \cdot \begin{pmatrix} x \\ y \\ 1 \end{pmatrix}.$$

- b. Give a similar representation for affine transformations of  $\mathbb{R}^3$  using  $4 \times 4$  matrices.
3. In this exercise, we will reconsider the hand orientation for the robots in Examples 1 and 2. Namely, let  $\alpha = \theta_1 + \theta_2 + \theta_3$  be the angle giving the hand orientation in the  $(x_1, y_1)$  coordinate system.
    - a. Using the trigonometric addition formulas, show that

$$c = \cos \alpha, \quad s = \sin \alpha$$

can be expressed as polynomials in  $c_i = \cos \theta_i$  and  $s_i = \sin \theta_i$ . Thus, the whole mapping  $f$  can be expressed in polynomial form, at the cost of introducing an extra coordinate function for  $\mathcal{C}$ .

- b. Express  $c$  and  $s$  using the rational parametrization (8) of the circle.
4. Consider a planar robot with a revolute joint 1, segment 2 of length  $l_2$ , a prismatic joint 2 with settings  $l_3 \in [0, m_3]$ , and a revolute joint 3, with segment 4 being the hand.
    - a. What are the joint and configuration spaces  $\mathcal{J}$  and  $\mathcal{C}$  for this robot?

- b. Using the method of Examples 1 and 2, construct an explicit formula for the mapping  $f : \mathcal{J} \rightarrow \mathcal{C}$  in terms of the trigonometric functions of the joint angles.
  - c. Convert the function  $f$  into a polynomial mapping by introducing suitable new coordinates.
5. Rewrite the mappings  $f$  and  $g$  in Examples 1 and 2, respectively, using the rational parametrization (8) of the circle for each revolute joint. Show that in each case the hand position and orientation are given by rational mappings on  $\mathbb{R}^n$ . (The value of  $n$  will be different in the two examples.)
  6. Rewrite the mapping  $f$  for the robot from Exercise 4, using the rational parametrization (8) of the circle for each revolute joint.
  7. Consider a planar robot with a fixed segment 1 as in our examples in this section and with  $n$  revolute joints linking segments of length  $l_2, \dots, l_n$ . The hand is segment  $n + 1$ , attached to segment  $n$  by joint  $n$ .
    - a. What are the joint and configuration spaces for this robot?
    - b. Show that the mapping  $f : \mathcal{J} \rightarrow \mathcal{C}$  for this robot has the form

$$f(\theta_1, \dots, \theta_n) = \begin{pmatrix} \sum_{i=1}^{n-1} l_{i+1} \cos\left(\sum_{j=1}^i \theta_j\right) \\ \sum_{i=1}^{n-1} l_{i+1} \sin\left(\sum_{j=1}^i \theta_j\right) \\ \sum_{i=1}^n \theta_i \end{pmatrix}.$$

Hint: Argue by induction on  $n$ .

8. Another type of 3-dimensional joint is a “spin” or nonplanar revolute joint that allows one segment to rotate or spin in the plane perpendicular to the other segment. In this exercise, we will study the forward kinematic problem for a 3-dimensional robot containing two “spin” joints. As usual, segment 1 of the robot will be fixed, and we will pick a global coordinate system  $(x_1, y_1, z_1)$  with the origin at joint 1 and segment 1 on the  $z_1$ -axis. Joint 1 is a “spin” joint with rotation axis along the  $z_1$ -axis, so that segment 2 rotates in the  $(x_1, y_1)$ -plane. Then segment 2 has length  $l_2$  and joint 2 is a second “spin” joint connecting segment 2 to segment 3. The axis for joint 2 lies along segment 2, so that segment 3 always rotates in the plane perpendicular to segment 2.
  - a. Construct a local right-handed orthogonal coordinate system  $(x_2, y_2, z_2)$  with origin at joint 1, with the  $x_2$ -axis in the direction of segment 2 and the  $y_2$ -axis in the  $(x_1, y_1)$ -plane. Give an explicit formula for the  $(x_1, y_1, z_1)$  coordinates of a general point, in terms of its  $(x_2, y_2, z_2)$  coordinates and of the joint angle  $\theta_1$ .
  - b. Express your formula from part (a) in matrix form, using the  $4 \times 4$  matrix representation for affine space transformations given in part (b) of Exercise 2.
  - c. Now, construct a local orthogonal coordinate system  $(x_3, y_3, z_3)$  with origin at joint 2, the  $x_3$ -axis in the direction of segment 3, and the  $z_3$ -axis in the direction of segment 2. Give an explicit formula for the  $(x_2, y_2, z_2)$  coordinates of a point in terms of its  $(x_3, y_3, z_3)$  coordinates and the joint angle  $\theta_2$ .
  - d. Express your formula from part (c) in matrix form.
  - e. Give the transformation relating the  $(x_3, y_3, z_3)$  coordinates of a general point to its  $(x_1, y_1, z_1)$  coordinates in matrix form. Hint: This will involve suitably multiplying the matrices found in parts (b) and (d).
9. Consider the robot from Exercise 8.
  - a. Using the result of part c of Exercise 8, give an explicit formula for the mapping  $f : \mathcal{J} \rightarrow \mathcal{C}$  for this robot.
  - b. Express the hand position for this robot as a polynomial function of the variables  $c_i = \cos \theta_i$  and  $s_i = \sin \theta_i$ .

- c. The orientation of the hand (the end of segment 3) of this robot can be expressed by giving a unit vector in the direction of segment 3, expressed in the global coordinate system. Find an expression for the hand orientation.

### §3 The Inverse Kinematic Problem and Motion Planning

In this section, we will continue the discussion of the robot kinematic problems introduced in §1. To begin, we will consider the inverse kinematic problem for the planar robot arm with three revolute joints studied in Example 1 of §2. Given a point  $(x_1, y_1) = (a, b) \in \mathbb{R}^2$  and an orientation, we wish to determine whether it is possible to place the hand of the robot at that point with that orientation. If it is possible, we wish to find all combinations of joint settings that will accomplish this. In other words, we want to determine the *image* of the mapping  $f : \mathcal{J} \rightarrow \mathcal{C}$  for this robot; for each  $c$  in the image of  $f$ , we want to determine the *inverse image*  $f^{-1}(c)$ .

It is quite easy to see geometrically that if  $l_3 = l_2 = l$ , the hand of our robot can be placed at any point of the closed disk of radius  $2l$  centered at joint 1—the origin of the  $(x_1, y_1)$  coordinate system. On the other hand, if  $l_3 \neq l_2$ , then the hand positions fill out a closed annulus centered at joint 1. (See, for example, the ideas used in Exercise 14 of Chapter 1, §2.) We will also be able to see this using the solution of the forward problem derived in equation (6) of §2. In addition, our solution will give *explicit formulas* for the joint settings necessary to produce a given hand position. Such formulas could be built into a control program for a robot of this kind.

For this robot, it is also easy to control the hand orientation. Since the setting of joint 3 is independent of the settings of joints 1 and 2, we see that, given any  $\theta_1$  and  $\theta_2$ , it is possible to attain any desired orientation  $\alpha = \theta_1 + \theta_2 + \theta_3$  by setting  $\theta_3 = \alpha - (\theta_1 + \theta_2)$  accordingly.

To simplify our solution of the inverse kinematic problem, we will use the above observation to ignore the hand orientation. Thus, we will concentrate on the position of the hand, which is a function of  $\theta_1$  and  $\theta_2$  alone. From equation (6) of §2, we see that the possible ways to place the hand at a given point  $(x_1, y_1) = (a, b)$  are described by the following system of polynomial equations:

$$(1) \quad \begin{aligned} a &= l_3(c_1c_2 - s_1s_2) + l_2c_1, \\ b &= l_3(c_1s_2 + c_2s_1) + l_2s_1, \\ 0 &= c_1^2 + s_1^2 - 1, \\ 0 &= c_2^2 + s_2^2 - 1 \end{aligned}$$

for  $s_1, c_1, s_2, c_2$ . To solve these equations, we compute a Groebner basis using lex order with the variables ordered

$$c_2 > s_2 > c_1 > s_1.$$

Our solutions will depend on the values of  $a, b, l_2, l_3$ , which appear as symbolic



parameters in the coefficients of the Groebner basis:

$$\begin{aligned}
 & c_2 - \frac{a^2 + b^2 - l_2^2 - l_3^2}{2l_2l_3}, \\
 & s_2 + \frac{a^2 + b^2}{al_3}s_1 - \frac{a^2b + b^3 + b(l_2^2 - l_3^2)}{2al_2l_3}, \\
 (2) \quad & c_1 + \frac{b}{a}s_1 - \frac{a^2 + b^2 + l_2^2 - l_3^2}{2al_2}, \\
 & s_1^2 - \frac{a^2b + b^3 + b(l_2^2 - l_3^2)}{l_2(a^2 + b^2)}s_1 \\
 & \quad + \frac{(a^2 + b^2)^2 + (l_2^2 - l_3^2)^2 - 2a^2(l_2^2 + l_3^2) + 2b^2(l_2^2 - l_3^2)}{4l_2^2(a^2 + b^2)}.
 \end{aligned}$$

In algebraic terms, this is the reduced Groebner basis for the ideal  $I$  generated by the polynomials in (1) in the ring  $\mathbb{R}(a, b, l_2, l_3)[s_1, c_1, s_2, c_2]$ . That is, we allow denominators that depend only on the parameters  $a, b, l_2, l_3$ .

This is the first time we have computed a Groebner basis over a field of rational functions and one has to be a bit careful about how to interpret (2). Working over  $\mathbb{R}(a, b, l_2, l_3)$  means that  $a, b, l_2, l_3$  are abstract variables over  $\mathbb{R}$ , and, in particular, they are algebraically independent [i.e., if  $p$  is a polynomial with real coefficients such that  $p(a, b, l_2, l_3) = 0$ , then  $p$  must be the zero polynomial]. Yet, in practice, we want  $a, b, l_2, l_3$  to be certain specific real numbers. When we make such a substitution, the polynomials (1) generate an ideal  $\bar{I} \subset \mathbb{R}[c_1, s_1, c_2, s_2]$  corresponding to a specific hand position of a robot with specific segment lengths. The key question is whether (2) remains a Groebner basis for  $\bar{I}$  under this substitution. In general, the replacement of variables by specific values in a field is called *specialization*, and the question is how a Groebner basis behaves under specialization.

A first observation is that we expect problems when a specialization causes any of the denominators in (2) to vanish. This is typical of how specialization works: things usually behave nicely for most (but not all) values of the variables. In the exercises, you will prove that there is a proper subvariety  $W \subset \mathbb{R}^4$  such that (2) specializes to a Groebner basis of  $\bar{I}$  whenever  $a, b, l_2, l_3$  take values in  $\mathbb{R}^4 - W$ . We also will see that there is an algorithm for finding  $W$ . The subtle point is that, in general, the vanishing of denominators is not the only thing that can go wrong (you will work out some examples in the exercises). Fortunately, in the example we are considering, it can be shown that  $W$  is, in fact, defined by the vanishing of the denominators. This means that if we choose values  $l_2 \neq 0, l_3 \neq 0, a \neq 0$ , and  $a^2 + b^2 \neq 0$ , then (2) still gives a Groebner basis of (1). The details of the argument will be given in Exercise 9.

Given such a specialization, two observations follow immediately from the form of the leading terms of the Groebner basis (2). First, any zero  $s_1$  of the last polynomial can be extended uniquely to a full solution of the system. Second, the set of solutions of (1) is a *finite* set for this choice of  $a, b, l_2, l_3$ . Indeed, since the last polynomial in (2) is quadratic in  $s_1$ , there can be at most *two* distinct solutions. It remains to see which  $a, b$  yield *real* values for  $s_1$  (the relevant solutions for the geometry of our robot).

To simplify the formulas somewhat, we will specialize to the case  $l_2 = l_3 = 1$ . In Exercise 1, you will show that by either substituting  $l_2 = l_3 = 1$  directly into (2) or setting  $l_2 = l_3 = 1$  in (1) and recomputing a Groebner basis in  $\mathbb{R}(a, b)[s_1, c_1, s_2, c_2]$ , we obtain the same result:

$$(3) \quad \begin{aligned} c_2 - \frac{a^2 + b^2 - 2}{2}, \\ s_2 + \frac{a^2 + b^2}{a}s_1 - \frac{a^2b + b^3}{2a}, \\ c_1 + \frac{b}{a}s_1 - \frac{a^2 + b^2}{2a}, \\ s_1^2 - bs_1 + \frac{(a^2 + b^2)^2 - 4a^2}{4(a^2 + b^2)}. \end{aligned}$$

Other choices for  $l_2$  and  $l_3$  will be studied in Exercise 4. [Although (2) remains a Groebner basis for any nonzero values of  $l_2$  and  $l_3$ , the geometry of the situation changes rather dramatically if  $l_2 \neq l_3$ .]

It follows from our earlier remarks that (3) is a Groebner basis for (1) for all specializations of  $a$  and  $b$  where  $a \neq 0$  and  $a^2 + b^2 \neq 0$ . Thus, the hand positions with  $a = 0$  or  $a = b = 0$  appear to have some special properties. We will consider the general case  $a \neq 0$  first. Note that this implies  $a^2 + b^2 \neq 0$  as well since  $a, b \in \mathbb{R}$ . Solving the last equation in (3) by the quadratic formula, we find that

$$s_1 = \frac{b}{2} \pm \frac{|a|\sqrt{4 - (a^2 + b^2)}}{2\sqrt{a^2 + b^2}}.$$

Note that the solution(s) of this equation are real if and only if  $0 < a^2 + b^2 \leq 4$ , and when  $a^2 + b^2 = 4$ , we have a double root. From the geometry of the system, that is exactly what we expect. The distance from joint 1 to joint 3 is at most  $l_2 + l_3 = 2$ , and positions with  $l_2 + l_3 = 2$  can be reached in only one way—by setting  $\theta_2 = 0$  so that segment 3 and segment 2 are pointing in the same direction.

Given  $s_1$ , we may solve for  $c_1, s_2, c_2$  using the other elements of the Groebner basis (3). Since  $a \neq 0$ , we obtain exactly one value for each of these variables for each possible  $s_1$  value. (In fact, the value of  $c_2$  does not depend on  $s_1$ —see Exercise 2.) Further, since  $c_1^2 + s_1^2 - 1$  and  $c_2^2 + s_2^2 - 1$  are in the ideal generated by (3), the values we get for  $s_1, c_1, s_2, c_2$ , uniquely determine the joint angles  $\theta_1$  and  $\theta_2$ . Thus, the cases where  $a \neq 0$  are easily handled.

We now take up the case of the possible values of  $s_1, c_1, s_2, c_2$  when  $a = b = 0$ . Geometrically, this means that joint 3 is placed at the origin of the  $(x_1, y_1)$  system—at the same point as joint 1. Most of the polynomials in our basis (2) are undefined when we try to substitute  $a = b = 0$  in the coefficients. So this is a case where specialization fails. With a little thought, the geometric reason for this is visible. There are actually *infinitely many* different possible configurations that will place joint 3 at the origin since segments 2 and 3 have equal lengths. The angle  $\theta_1$  can be specified arbitrarily, then setting  $\theta_2 = \pi$  will fold segment 3 back along segment 2, placing joint 3 at  $(0, 0)$ .

These are the only joint settings placing the hand at  $(a, b) = (0, 0)$ . You will derive the same results by a different method in Exercise 3.

Finally, we ask what happens if  $a = 0$  but  $b \neq 0$ . From the geometry of the robot arm, we would guess that there should be nothing out of the ordinary about these points. Indeed, we could handle them simply by changing coordinates (rotating the  $x_1$ -,  $y_1$ -axes, for example) to make the first coordinate of the hand position any nonzero number. Nevertheless, there is an *algebraic* problem since some denominators in (2) vanish at  $a = 0$ . This is another case where specialization fails. In such a situation, we must substitute  $a = 0$  (and  $l_2 = l_3 = 1$ ) into (1) and then recompute the Groebner basis. We obtain

$$(4) \quad \begin{aligned} c_2 - \frac{b^2 - 2}{2}, \\ s_2 - bc_1, \\ c_1^2 + \frac{b^2 - 4}{4}, \\ s_1 - \frac{b}{2}. \end{aligned}$$

Note that the *form* of the Groebner basis for the ideal is different under this specialization. One difference between this basis and the general form (2) is that the equation for  $s_1$  now has degree 1. Also, the equation for  $c_1$  (rather than the equation for  $s_1$ ) has degree 2. Thus, we obtain two distinct real values for  $c_1$  if  $|b| < 2$  and one value for  $c_1$  if  $|b| = 2$ . As in the case  $a \neq 0$  above, there are at most two distinct solutions, and the solutions coincide when we are at a point on the boundary of the disk of radius 2. In Exercise 2, you will analyze the geometric meaning of the solutions with  $a = 0$  and explain why there is only one distinct value for  $s_1$  in this special case.

This completes the analysis of our robot arm. To summarize, given any  $(a, b)$  in  $(x_1, y_1)$  coordinates, to place joint 3 at  $(a, b)$ , there are

- infinitely many distinct settings of joint 1 when  $a^2 + b^2 = 0$ ,
- two distinct settings of joint 1 when  $a^2 + b^2 < 4$ ,
- one setting of joint 1 when  $a^2 + b^2 = 4$ ,
- no possible settings of joint 1 when  $a^2 + b^2 > 4$ .

The cases  $a^2 + b^2 = 0, 4$  (but *not* the special cases  $a = 0, b \neq 0$ ) are examples of what are known as *kinematic singularities* for this robot. We will give a precise definition of this concept and discuss some of its meaning below.

In the exercises, you will consider the robot arm with three revolute joints and one prismatic joint introduced in Example 2 of §2. There are more restrictions here for the hand orientation. For example, if  $l_4$  lies in the interval  $[0, 1]$ , then the hand can be placed in any position in the closed disk of radius 3 centered at  $(x_1, y_1) = (0, 0)$ . However, an interesting difference is that points on the boundary circle can only be reached with one hand orientation.

Before continuing our discussion of robotics, let us make some final comments about specialization. In the example given above, we assumed that we could compute Groebner bases over function fields. In practice, not all computer algebra systems

can do this directly—some systems do not allow the coefficients to lie in a function field. The standard method for avoiding this difficulty will be explored in Exercise 10. Another question is how to determine which specializations are the bad ones. One way to attack this problem will be discussed in Exercise 8. Finally, we should mention that there is a special kind of Groebner basis, called a *comprehensive Groebner basis*, which has the property that it remains a Groebner basis under *all* specializations. Such Groebner bases are discussed in the appendix to BECKER and WEISPFENNING (1993).

We will conclude our discussion of the geometry of robots by studying kinematic singularities and some of the issues they raise in robot motion planning. The following discussion will use some ideas from advanced multivariable calculus that we have not encountered before.

Let  $f : \mathcal{J} \rightarrow \mathcal{C}$  be the function expressing the hand configuration as a function of the joint settings. In the explicit parametrizations of the space  $\mathcal{J}$  that we have used, each component of  $f$  is a differentiable function of the variables  $\theta_i$ . For example, this is clearly true for the mapping  $f$  for a planar robot with three revolute joints:

$$(5) \quad f(\theta_1, \theta_2, \theta_3) = \begin{pmatrix} l_3 \cos(\theta_1 + \theta_2) + l_2 \cos \theta_1 \\ l_3 \sin(\theta_1 + \theta_2) + l_2 \sin \theta_1 \\ \theta_1 + \theta_2 + \theta_3 \end{pmatrix}.$$

Hence, we can compute the Jacobian matrix (or matrix of partial derivatives) of  $f$  with respect to the variables  $\theta_1, \theta_2, \theta_3$ . We write  $f_i$  for the  $i$ -th component function of  $f$ . Then, by definition, the Jacobian matrix is

$$J_f(\theta_1, \theta_2, \theta_3) = \begin{pmatrix} \frac{\partial f_1}{\partial \theta_1} & \frac{\partial f_1}{\partial \theta_2} & \frac{\partial f_1}{\partial \theta_3} \\ \frac{\partial f_2}{\partial \theta_1} & \frac{\partial f_2}{\partial \theta_2} & \frac{\partial f_2}{\partial \theta_3} \\ \frac{\partial f_3}{\partial \theta_1} & \frac{\partial f_3}{\partial \theta_2} & \frac{\partial f_3}{\partial \theta_3} \end{pmatrix}.$$

For example, the mapping  $f$  in (5) has the Jacobian matrix

$$(6) \quad J_f(\theta_1, \theta_2, \theta_3) = \begin{pmatrix} -l_3 \sin(\theta_1 + \theta_2) - l_2 \sin \theta_1 & -l_3 \sin(\theta_1 + \theta_2) & 0 \\ l_3 \cos(\theta_1 + \theta_2) + l_2 \cos \theta_1 & l_3 \cos(\theta_1 + \theta_2) & 0 \\ 1 & 1 & 1 \end{pmatrix}.$$

From the matrix of functions  $J_f$ , we obtain matrices with constant entries by substituting particular values  $j = (\theta_1, \theta_2, \theta_3)$ . We will write  $J_f(j)$  for the substituted matrix, which plays an important role in advanced multivariable calculus. Its key property is that  $J_f(j)$  defines a linear mapping which is the *best linear approximation* of the function  $f$  at  $j \in \mathcal{J}$ . This means that near  $j$ , the function  $f$  and the linear function given by  $J_f(j)$  have roughly the same behavior. In this sense,  $J_f(j)$  represents the *derivative* of the mapping  $f$  at  $j \in \mathcal{J}$ .

To define what is meant by a kinematic singularity, we need first to assign *dimensions* to the joint space  $\mathcal{J}$  and the configuration space  $\mathcal{C}$  for our robot, to be denoted by  $\dim(\mathcal{J})$

and  $\dim(C)$ , respectively. We will do this in a very intuitive way. The dimension of  $\mathcal{J}$ , for example, will be simply the number of independent “degrees of freedom” we have in setting the joints. Each planar joint (revolute or prismatic) contributes 1 dimension to  $\mathcal{J}$ . Note that this yields a dimension of 3 for the joint space of the plane robot with three revolute joints. Similarly,  $\dim(C)$  will be the number of independent degrees of freedom we have in the configuration (position and orientation) of the hand. For our planar robot, this dimension is also 3.

In general, suppose we have a robot with  $\dim(\mathcal{J}) = m$  and  $\dim(C) = n$ . Then differentiating  $f$  as before, we will obtain an  $n \times m$  Jacobian matrix of functions. If we substitute in  $j \in \mathcal{J}$ , we get the linear map  $J_f(j) : \mathbb{R}^m \rightarrow \mathbb{R}^n$  that best approximates  $f$  near  $j$ . An important invariant of a matrix is its *rank*, which is the maximal number of linearly independent columns (or rows). The exercises will review some of the properties of the rank. Since  $J_f(j)$  is an  $n \times m$  matrix, its rank will always be less than or equal to  $\min(m, n)$ . For instance, consider our planar robot with three revolute joints and  $l_2 = l_3 = 1$ . If we let  $j = (0, \frac{\pi}{2}, \frac{\pi}{3})$ , then formula (6) gives us

$$J_f\left(0, \frac{\pi}{2}, \frac{\pi}{3}\right) = \begin{pmatrix} -1 & -1 & 0 \\ 1 & 0 & 0 \\ 1 & 1 & 1 \end{pmatrix}.$$

This matrix has rank exactly 3 (the largest possible in this case).

We say that  $J_f(j)$  has *maximal rank* if its rank is  $\min(m, n)$  (the largest possible value), and, otherwise,  $J_f(j)$  has *deficient rank*. When a matrix has deficient rank, its kernel is larger and image smaller than one would expect (see Exercise 14). Since  $J_f(j)$  closely approximates  $f$ ,  $J_f(j)$  having deficient rank should indicate some special or “singular” behavior of  $f$  itself near the point  $j$ . Hence, we introduce the following definition.

**Definition 1.** A **kinematic singularity** for a robot is a point  $j \in \mathcal{J}$  such that  $J_f(j)$  has rank strictly less than  $\min(\dim(\mathcal{J}), \dim(C))$ .

For example, the kinematic singularities of the 3-revolute joint robot occur exactly when the matrix (6) has rank  $\leq 2$ . For square  $n \times n$  matrices, having deficient rank is equivalent to the vanishing of the determinant. We have

$$\begin{aligned} 0 &= \det(J_f) = \sin(\theta_1 + \theta_2) \cos \theta_1 - \cos(\theta_1 + \theta_2) \sin \theta_1 \\ &= \sin \theta_2 \end{aligned}$$

if and only if  $\theta_2 = 0$  or  $\theta_2 = \pi$ . Note that  $\theta_2 = 0$  corresponds to a position in which segment 3 extends past segment 2 along the positive  $x_2$ -axis, whereas  $\theta_2 = \pi$  corresponds to a position in which segment 3 is folded back along segment 2. These are exactly the two special configurations we found earlier in which there are not exactly two joint settings yielding a particular hand configuration.

Kinematic singularities are essentially unavoidable for planar robot arms with three or more revolute joints.

**Proposition 2.** *Let  $f : \mathcal{J} \rightarrow \mathcal{C}$  be the configuration mapping for a planar robot with  $n \geq 3$  revolute joints. Then there exist kinematic singularities  $j \in \mathcal{J}$ .*

**Proof.** By Exercise 7 of §2, we know that  $f$  has the form

$$f(\theta_1, \dots, \theta_n) = \begin{pmatrix} \sum_{i=1}^{n-1} l_{i+1} \cos \left( \sum_{j=1}^i \theta_j \right) \\ \sum_{i=1}^{n-1} l_{i+1} \sin \left( \sum_{j=1}^i \theta_j \right) \\ \sum_{i=1}^n \theta_i \end{pmatrix}.$$

Hence, the Jacobian matrix  $J_f$  will be the  $3 \times n$  matrix

$$\begin{pmatrix} -\sum_{i=1}^{n-1} l_{i+1} \sin \left( \sum_{j=1}^i \theta_j \right) & -\sum_{i=2}^{n-1} l_{i+1} \sin \left( \sum_{j=1}^i \theta_j \right) & \dots & -l_n \sin(\theta_{n-1}) & 0 \\ \sum_{i=1}^{n-1} l_{i+1} \cos \left( \sum_{j=1}^i \theta_j \right) & \sum_{i=2}^{n-1} l_{i+1} \cos \left( \sum_{j=1}^i \theta_j \right) & \dots & l_n \cos(\theta_{n-1}) & 0 \\ 1 & 1 & \dots & 1 & 1 \end{pmatrix}.$$

Since we assume  $n \geq 3$ , by the definition, a kinematic singularity is a point where the rank of  $J_f$  is  $\leq 2$ . If  $j \in \mathcal{J}$  is a point where all  $\theta_i \in \{0, \pi\}$ , then every entry of the first row of  $J_f(j)$  is zero. Hence,  $\text{rank } J_f(j) \leq 2$  for those  $j$ .  $\square$

Descriptions of the possible motions of robots such as the ones we have developed are used in an essential way in *planning* the motions of the robot needed to accomplish the tasks that are set for it. The methods we have sketched are suitable (at least in theory) for implementation in programs to control robot motion automatically. The main goal of such a program would be to instruct the robot what joint setting changes to make in order to take the hand from one position to another. The basic problems to be solved here would be first, to find a *parametrized path*  $c(t) \in \mathcal{C}$  starting at the initial hand configuration and ending at the new desired configuration, and second, to find a corresponding path  $j(t) \in \mathcal{J}$  such that  $f(j(t)) = c(t)$  for all  $t$ . In addition, we might want to impose extra constraints on the paths used such as the following:

1. If the configuration space path  $c(t)$  is closed (i.e., if the starting and final configurations are the same), we might also want path  $j(t)$  to be a closed path. This would be especially important for robots performing a *repetitive* task such as making a certain weld on an automobile body. Making certain the joint space path is closed means that the whole cycle of joint setting changes can simply be repeated to perform the task again.
2. In any real robot, we would want to limit the *joint speeds* necessary to perform the prescribed motion. Overly fast (or rough) motions could damage the mechanisms.
3. We would want to do as little total joint movement as possible to perform each motion.

Kinematic singularities have an important role to play in motion planning. To see the undesirable behavior that can occur, suppose we have a configuration space path  $c(t)$  such that the corresponding joint space path  $j(t)$  passes through or near a kinematic singularity. Using the multivariable chain rule, we can differentiate  $c(t) = f(j(t))$  with

respect to  $t$  to obtain

$$(7) \quad c'(t) = J_f(j(t)) \cdot j'(t).$$

We can interpret  $c'(t)$  as the velocity of our configuration space path, whereas  $j'(t)$  is the corresponding *joint space velocity*. If at some time  $t_0$  our joint space path passes *through* a kinematic singularity for our robot, then, because  $J_f(j(t_0))$  is a matrix of deficient rank, equation (7) may have *no* solution for  $j'(t_0)$ , which means there may be *no* smooth joint paths  $j(t)$  corresponding to configuration paths that move in certain directions. As an example, consider the kinematic singularities with  $\theta_2 = \pi$  for our planar robot with three revolute joints. If  $\theta_1 = 0$ , then segments 2 and 3 point along the  $x_1$ -axis:

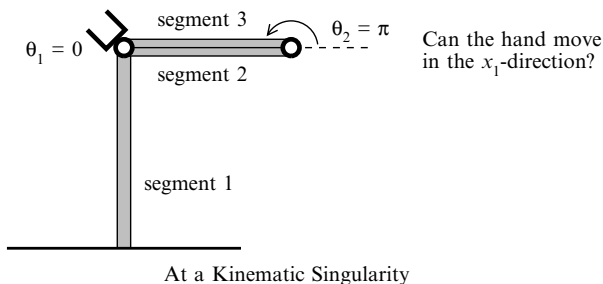

With segment 3 folded back along segment 2, there is no way to move the hand in the  $x_1$ -direction. More precisely, suppose that we have a configuration path such that  $c'(t_0)$  is in the direction of the  $x_1$ -axis. Then, using formula (6) for  $J_f$ , equation (7) becomes

$$c'(t_0) = J_f(t_0) \cdot j'(t_0) = \begin{pmatrix} 0 & 0 & 0 \\ 0 & -1 & 0 \\ 1 & 1 & 1 \end{pmatrix} \cdot j'(t_0).$$

Because the top row of  $J_f(t_0)$  is identically zero, this equation has no solution for  $j'(t_0)$  since we want the  $x_1$  component of  $c'(t_0)$  to be nonzero. Thus,  $c(t)$  is a configuration path for which there is no corresponding smooth path in joint space. This is typical of what can go wrong at a kinematic singularity.

For  $j(t_0)$  near a kinematic singularity, we may still have bad behavior since  $J_f(j(t_0))$  may be close to a matrix of deficient rank. Using techniques from numerical linear algebra, it can be shown that in (7), if  $J_f(j(t_0))$  is close to a matrix of deficient rank, very large joint space velocities may be needed to achieve a small configuration space velocity. For a simple example of this phenomenon, again consider the kinematic singularities of our planar robot with 3 revolute joints with  $\theta_2 = \pi$  (where segment 3 is folded back along segment 2). As the diagram on the next page suggests, in order to move from position A to position B, both near the origin, a large change in  $\theta_1$  will be needed to move the hand a short distance.

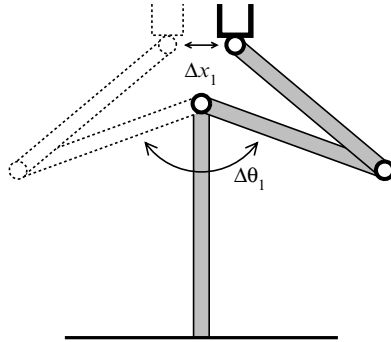

Near a Kinematic Singularity

To avoid undesirable situations such as this, care must be taken in specifying the desired configuration space path  $c(t)$ . The study of methods for doing this in a systematic way is an active field of current research in robotics, and unfortunately beyond the scope of this text. For readers who wish to pursue this topic further, a standard basic reference on robotics is the text by PAUL (1981). The survey by BUCHBERGER (1985) contains another discussion of Groebner basis methods for the inverse kinematic problem. A readable introduction to much of the more recent work on the inverse kinematic problem and motion control, with references to the original research papers, is given in BAILLIEUL ET AL. (1990).

**EXERCISES FOR §3**

1. Consider the specialization of the Groebner basis (2) to the case  $l_2 = l_3 = 1$ .
  - a. First, substitute  $l_2 = l_3 = 1$  directly into (2) and simplify.
  - b. Now, set  $l_2 = l_3 = 1$  in (1) and compute a Groebner basis for the “specialized” ideal generated by (1), again using lex order with  $c_2 > s_2 > c_1 > s_1$ . Compare with your results from part (a) (Your results should be the same.)
2. This exercise studies the geometry of the planar robot with three revolute joints discussed in the text with the dimensions specialized to  $l_2 = l_3 = 1$ .
  - a. Draw a diagram illustrating the two solutions of the inverse kinematic problem for the robot in the general case  $a \neq 0, a^2 + b^2 \neq 4$ . Why is  $c_2$  independent of  $s_1$  here? Hint: What kind of quadrilateral is formed by the segments of the robot in the two possible settings to place the hand at  $(a, b)$ ? How are the two values of  $\theta_2$  related?
  - b. By drawing a diagram, or otherwise, explain the meaning of the two solutions of (4) in the case  $a = 0$ . In particular, explain why it is reasonable that  $s_1$  has only one value. Hint: How are the two values of  $\theta_1$  in your diagram related?
3. Consider the robot arm discussed in the text with  $l_2 = l_3 = 1$ . Set  $a = b = 0$  in (1) and recompute a Groebner basis for the ideal. How is this basis different from the bases (3) and (4)? How does this difference explain the properties of the kinematic singularity at  $(0, 0)$ ?
4. In this exercise, you will study the geometry of the robot discussed in the text when  $l_2 \neq l_3$ .
  - a. Set  $l_2 = 1, l_3 = 2$  and solve the system (2) for  $s_1, c_1, s_2, c_2$ . Interpret your results geometrically, identifying and explaining all special cases. How is this case different from the case  $l_2 = l_3 = 1$  done in the text?
  - b. Now, set  $l_2 = 2, l_3 = 1$  and answer the same questions as in part (a).



As we know from the examples in the text, the form of a Groebner basis for an ideal can change if symbolic parameters appearing in the coefficients take certain special values. In Exercises 5–9, we will study some further examples of this phenomenon and prove some general results.

5. We begin with another example of how denominators in a Groebner basis can cause problems under specialization. Consider the ideal  $I = \langle f, g \rangle$ , where  $f = x^2 - y$ ,  $g = (y - tx)(y - t) = -txy + t^2x + y^2 - ty$ , and  $t$  is a symbolic parameter. We will use lex order with  $x > y$ .
  - a. Compute a reduced Groebner basis for  $I$  in  $\mathbb{R}(t)[x, y]$ . What polynomials in  $t$  appear in the denominators in this basis?
  - b. Now set  $t = 0$  in  $f, g$  and recompute a Groebner basis. How is this basis different from the one in part (a)? What if we clear denominators in the basis from part a and set  $t = 0$ ?
  - c. How do the points in the variety  $\mathbf{V}(I) \subset \mathbb{R}^2$  depend on the choice of  $t \in \mathbb{R}$ . Is it reasonable that  $t = 0$  is a special case?
  - d. The first step of Buchberger’s algorithm to compute a Groebner basis for  $I$  would be to compute the S-polynomial  $S(f, g)$ . Compute this S-polynomial by hand in  $\mathbb{R}(t)[x, y]$ . Note that the special case  $t = 0$  is already distinguished at this step.
6. This exercise will explore a more subtle example of what can go wrong during a specialization. Consider the ideal  $I = \langle x + ty, x + y \rangle \subset \mathbb{R}(t)[x, y]$ , where  $t$  is a symbolic parameter. We will use lex order with  $x > y$ .
  - a. Show that  $\{x, y\}$  is a reduced Groebner basis of  $I$ . Note that neither the original basis nor the Groebner basis have any denominators.
  - b. Let  $t = 1$  and show that  $\{x + y\}$  is a Groebner basis for the specialized ideal  $\bar{I} \subset \mathbb{R}[x, y]$ .
  - c. To see why  $t = 1$  is special, express the Groebner basis  $\{x, y\}$  in terms of the original basis  $\{x + ty, x + y\}$ . What denominators do you see? In the next problem, we will explore the general case of what is happening here.
7. In this exercise, we will derive a condition under which the form of a Groebner basis *does not* change under specialization. Consider the ideal

$$I = \langle f_i(t_1, \dots, t_m, x_1, \dots, x_n) : 1 \leq i \leq s \rangle$$

in  $k(t_1, \dots, t_m)[x_1, \dots, x_n]$  and fix a monomial order. We think of  $t_1, \dots, t_m$  as symbolic parameters appearing in the coefficients of  $f_1, \dots, f_s$ . By dividing each  $f_i$  by its leading coefficient [which lies in  $k(t_1, \dots, t_m)$ ], we may assume that the leading coefficients of the  $f_i$  are all equal to 1. Then let  $\{g_1, \dots, g_t\}$  be a reduced Groebner basis for  $I$ . Thus the leading coefficients of the  $g_i$  are also 1. Finally, let  $(t_1, \dots, t_m) \mapsto (a_1, \dots, a_m) \in k^m$  be a specialization of the parameters such that none of the denominators of the  $f_i$  or  $g_i$  vanish at  $(a_1, \dots, a_m)$ .

- a. If we use the division algorithm to find  $A_{ij} \in k(t_1, \dots, t_m)[x_1, \dots, x_n]$  such that

$$f_i = \sum_{j=1}^t A_{ij} g_j,$$

then show that none of the denominators of  $A_{ij}$  vanish at  $(a_1, \dots, a_m)$ .

- b. We also know that  $g_j$  can be written

$$g_j = \sum_{i=1}^s B_{ji} f_i,$$

for some  $B_{ij} \in k(t_1, \dots, t_m)[x_1, \dots, x_n]$ . As Exercise 6 shows, the  $B_{ji}$  may introduce new denominators. So assume, in addition, that none of the denominators of the  $B_{ji}$

vanish under the specialization  $(t_1, \dots, t_m) \mapsto (a_1, \dots, a_m)$ . Let  $\bar{I}$  denote the ideal in  $k[x_1, \dots, x_n]$  generated by the specialized  $f_i$ . Under these assumptions, prove that the specialized  $g_j$  form a basis of  $\bar{I}$ .

- c. Show that the specialized  $g_j$  form a Groebner basis for  $\bar{I}$ . Hint: The monomial order used to compute  $\bar{I}$  only deals with terms in the variables  $x_j$ . The parameters  $t_j$  are “constants” as far as the ordering is concerned.
  - d. Let  $d_1, \dots, d_M \in k[t_1, \dots, t_m]$  be all denominators that appear among  $f_i, g_j$ , and  $B_{ji}$ , and let  $W = \mathbf{V}(d_1 \cdot d_2 \cdots d_M) \subset k^m$ . Conclude that the  $g_j$  remain a Groebner basis for the  $f_i$  under all specializations  $(t_1, \dots, t_m) \mapsto (a_1, \dots, a_m) \in k^m - W$ .
8. We next describe an algorithm for finding which specializations preserve a Groebner basis. We will use the notation of Exercise 7. Thus, we want an algorithm for finding the denominators  $d_1, \dots, d_M$  appearing in the  $f_i, g_j$ , and  $B_{ji}$ . This is easy to do for the  $f_i$  and  $g_j$ , but the  $B_{ji}$  are more difficult. The problem is that since the  $f_i$  are not a Groebner basis, we cannot use the division algorithm to find the  $B_{ji}$ . Fortunately, we only need the denominators. The idea is to work in the ring  $k[t_1, \dots, t_m, x_1, \dots, x_n]$ . If we multiply the  $f_i$  and  $g_j$  by suitable polynomials in  $k[t_1, \dots, t_m]$ , we get

$$\tilde{f}_i, \tilde{g}_j \in k[t_1, \dots, t_m, x_1, \dots, x_n].$$

Let  $\bar{I} \subset k[t_1, \dots, t_m, x_1, \dots, x_n]$  be the ideal generated by the  $\tilde{f}_i$ .

- a. Suppose  $g_j = \sum_{i=1}^s B_{ji} f_i$  in  $k(t_1, \dots, t_m)[x_1, \dots, x_n]$  and let  $d \in k[t_1, \dots, t_m]$  be a polynomial that clears all denominators for the  $g_j$ , the  $f_i$ , and the  $B_{ji}$ . Then prove that

$$d \in (\bar{I} : \tilde{g}_j) \cap k[t_1, \dots, t_m],$$

where  $\bar{I} : \tilde{g}_j$  is the ideal quotient as defined in §4 of Chapter 4.

- b. Give an algorithm for computing  $(\bar{I} : \tilde{g}_j) \cap k[t_1, \dots, t_m]$  and use this to describe an algorithm for finding the subset  $W \subset k^m$  described in part (d) of Exercise 7.
9. The algorithm described in Exercise 8 can lead to lengthy calculations which may be too much for some computer algebra systems. Fortunately, quicker methods are available in some cases. Let  $f_i, g_j \in k(t_1, \dots, t_m)[x_1, \dots, x_n]$  be as in Exercises 7 and 8, and suppose we suspect that the  $g_j$  will remain a Groebner basis for the  $f_i$  under all specializations where the denominators of the  $f_i$  and  $g_j$  do not vanish. How can we check this quickly?
- a. Let  $d \in k[t_1, \dots, t_m]$  be the least common multiple of all denominators in the  $f_i$  and  $g_j$  and let  $\tilde{f}_i, \tilde{g}_j \in k[t_1, \dots, t_m, x_1, \dots, x_n]$  be the polynomials we get by clearing denominators. Finally, let  $\bar{I}$  be the ideal in  $k[t_1, \dots, t_m, x_1, \dots, x_n]$  generated by the  $\tilde{f}_i$ . If  $d\tilde{g}_j \in \bar{I}$  for all  $j$ , then prove that specialization works for all  $(t_1, \dots, t_m) \mapsto (a_1, \dots, a_m) \in k^m - \mathbf{V}(d)$ .
  - b. Describe an algorithm for checking the criterion given in part a. For efficiency, what monomial order should be used?
  - c. Apply the algorithm of part (b) to equations (1) in the text. This will prove that (2) remains a Groebner basis for (1) under all specializations where  $l_2 \neq 0, l_3 \neq 0, a \neq 0$ , and  $a^2 + b^2 \neq 0$ .
10. In this exercise, we will learn how to compute a Groebner basis for an ideal in  $k(t_1, \dots, t_m)[x_1, \dots, x_n]$  by working in the polynomial ring  $k[t_1, \dots, t_m, x_1, \dots, x_n]$ . This is useful when computing Groebner bases using computer algebra systems that won't allow the coefficients to lie in a function field. The first step is to fix a term order such that any monomial involving one of the  $x_i$ 's is greater than all monomials in  $t_1, \dots, t_m$  alone. For example, one could use a product order or lex order with  $x_1 > \dots > x_n > t_1 > \dots > t_n$ .

- a. If  $I$  is an ideal in  $k(t_1, \dots, t_m)[x_1, \dots, x_n]$ , show that  $I$  can be written in the form

$$I = \langle f_i(t_1, \dots, t_m, x_1, \dots, x_n) : 1 \leq i \leq s \rangle,$$

where each  $f_i \in k[t_1, \dots, t_m, x_1, \dots, x_n]$ .

- b. Now let  $\tilde{I}$  be the ideal in  $k[t_1, \dots, t_m, x_1, \dots, x_n]$  generated by  $f_1, \dots, f_s$ , and let  $g_1, \dots, g_t$  be a reduced Groebner basis for  $\tilde{I}$  with respect to the above term order. If any of the  $g_i$  lie in  $k[t_1, \dots, t_m]$  show that  $I = k(t_1, \dots, t_m)[x_1, \dots, x_n]$ .
- c. Let  $g_1, \dots, g_t$  be the Groebner basis of  $\tilde{I}$  from part b, and assume that none of the  $g_i$  lie in  $k[t_1, \dots, t_m]$ . Then prove that  $g_1, \dots, g_t$  are a Groebner basis for  $I$  (using the term order induced on monomials in  $x_1, \dots, x_n$ ).
11. Consider the planar robot with two revolute joints and one prismatic joint described in Exercise 4 of §2.
- a. Given a desired hand position and orientation, set up a system of equations as in (1) of this section whose solutions give the possible joint settings to reach that hand configuration. Take the length of segment 2 to be 1.
- b. Using a computer algebra system, solve your equations by computing a Groebner basis for the ideal generated by the equations from part (a) with respect to a suitable lex order. Note: Some experimentation may be necessary to find a reasonable variable order.
- c. What is the solution of the inverse kinematic problem for this robot. That is, which hand positions and orientations are possible? How many different joint settings yield a given hand configuration? (Do not forget that the setting of the prismatic joint is limited to a finite interval in  $[0, m_3] \subset \mathbb{R}$ .)
- d. Does this robot have any kinematic singularities according to Definition 1? If so, describe them.
12. Consider the planar robot with three joints and one prismatic joint that we studied in Example 2 of § 2.
- a. Given a desired hand position and orientation, set up a system of equations as in (1) of this section whose solutions give the possible joint settings to reach that hand configuration. Assume that segments 2 and 3 have length 1, and that segment 4 varies in length between 1 and 2. Note: Your system of equations for this robot *should* involve the hand orientation.
- b. Solve your equations by computing a Groebner basis for the ideal generated by your equations with respect to a suitable lex order. Note: Some experimentation may be necessary to find a reasonable variable order. The “wrong” variable order can lead to a completely intractable problem in this example.
- c. What is the solution of the inverse kinematic problem for this robot? That is, which hand positions and orientations are possible? How does the set of possible hand orientations vary with the position? (Do not forget that the setting  $l_4$  of the prismatic joint is limited to the finite interval in  $[1, 2] \subset \mathbb{R}$ .)
- d. How many different joint settings yield a given hand configuration in general? Are these special cases?
- e. Does this robot have any kinematic singularities according to Definition 1? If so, describe the corresponding robot configurations and relate them to part (d).
13. Consider the 3-dimensional robot with two “spin” joints from Exercise 8 of §2.
- a. Given a desired hand position and orientation, set up a system of equations as in (1) of this section whose solutions give the possible joint settings to reach that hand configuration. Take the length of segment 2 to be 4, and the length of segment 3 to be 2, if you like.
- b. Solve your equations by computing a Groebner basis for the ideal generated by your equations with respect to a suitable lex order. Note: In this case there will be an element

- of the Groebner basis that depends only on the hand position coordinates. What does this mean geometrically? Is your answer reasonable in terms of the geometry of this robot?
- c. What is the solution of the inverse kinematic problem for this robot? That is, which hand positions and orientations are possible?
  - d. How many different joint settings yield a given hand configuration in general? Are there special cases?
  - e. Does this robot have any kinematic singularities according to Definition 1?
14. Let  $A$  be an  $m \times n$  matrix with real entries. We will study the rank of  $A$ , which is the maximal number of linearly independent columns (or rows) in  $A$ . Multiplication by  $A$  gives a linear map  $L_A : \mathbb{R}^n \rightarrow \mathbb{R}^m$ , and from linear algebra, we know that the rank of  $A$  is the dimension of the image of  $L_A$ . As in the text,  $A$  has maximal rank if its rank is  $\min(m, n)$ . To understand what maximal rank means, there are three cases to consider.
- a. If  $m = n$ , show that  $A$  has maximal rank  $\Leftrightarrow \det(A) \neq 0 \Leftrightarrow L_A$  is an isomorphism of vector spaces.
  - b. If  $m < n$ , show that  $A$  has maximal rank  $\Leftrightarrow$  the equation  $A \cdot \mathbf{x} = \mathbf{b}$  has a solution for all  $\mathbf{b} \in \mathbb{R}^m \Leftrightarrow L_A$  is a surjective (onto) mapping.
  - c. If  $m > n$ , show that  $A$  has maximal rank  $\Leftrightarrow$  the equation  $A \cdot \mathbf{x} = \mathbf{b}$  has at most one solution for all  $\mathbf{b} \in \mathbb{R}^m \Leftrightarrow L_A$  is an injective (one-to-one) mapping.
15. A robot is said to be *kinematically redundant* if the dimension of its joint space  $\mathcal{J}$  is larger than the dimension of its configuration space  $\mathcal{C}$ .
- a. Which of the robots considered in this section (in the text and in Exercises 11–13 above) are kinematically redundant?
  - b. (This part requires knowledge of the Implicit Function Theorem.) Suppose we have a kinematically redundant robot and  $j \in \mathcal{J}$  is not a kinematic singularity. What can be said about the inverse image  $f^{-1}(f(j))$  in  $\mathcal{J}$ ? In particular, how many different ways are there to put the robot in the configuration given by  $f(j)$ ?
16. Verify the chain rule formula (7) explicitly for the planar robot with three revolute joints. Hint: Substitute  $\theta_i = \theta_i(t)$  and compute the derivative of the configuration space path  $f(\theta_1(t), \theta_2(t), \theta_3(t))$  with respect to  $t$ .

## §4 Automatic Geometric Theorem Proving

The geometric descriptions of robots and robot motion we studied in the first three sections of this chapter were designed to be used as tools by a control program to help plan the motions of the robot to accomplish a given task. In the process, the control program could be said to be “reasoning” about the geometric constraints given by the robot’s design and its environment and to be “deducing” a feasible solution to the given motion problem. In this section and in the next, we will examine a second subject which has some of the same flavor—automated geometric reasoning in general. We will give two algorithmic methods for determining the validity of general statements in Euclidean geometry. Such methods are of interest to researchers both in artificial intelligence (AI) and in geometric modeling because they have been used in the design of programs that, in effect, can prove or disprove conjectured relationships between, or theorems about, plane geometric objects.

Few people would claim that such programs embody an understanding of the *meaning* of geometric statements comparable to that of a human geometer. Indeed, the whole

question of whether a computer is capable of intelligent behavior is one that is still completely unresolved. However, it is interesting to note that a number of new (that is, apparently previously unknown) theorems have been verified by these methods. In a limited sense, these “theorem provers” are capable of “reasoning” about geometric configurations, an area often considered to be solely the domain of human intelligence.

The basic idea underlying the methods we will consider is that once we introduce Cartesian coordinates in the Euclidean plane, the hypotheses and the conclusions of a large class of geometric theorems can be expressed as *polynomial equations* between the coordinates of collections of points specified in the statements. Here is a simple but representative example.

**Example 1.** Let  $A, B, C, D$  be the vertices of a parallelogram in the plane, as in the figure below.

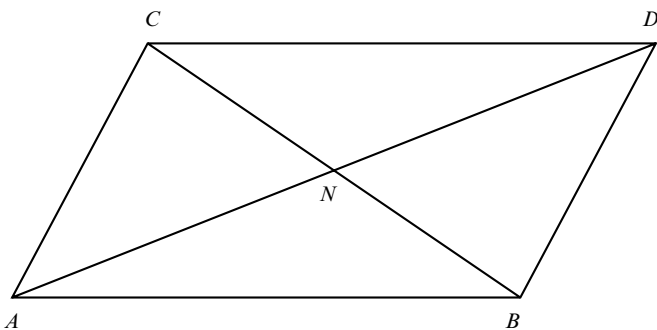

It is a standard geometric theorem that the two diagonals  $\overline{AD}$  and  $\overline{BC}$  of any parallelogram intersect at a point ( $N$  in the figure) which bisects both diagonals. In other words,  $AN = DN$  and  $BN = CN$ , where, as usual,  $XY$  denotes the length of the line segment  $\overline{XY}$  joining the two points  $X$  and  $Y$ . The usual proof from geometry is based on showing that the triangles  $\triangle ANC$  and  $\triangle BND$  are congruent. See Exercise 1.

To relate this theorem to algebraic geometry, we will show how the configuration of the parallelogram and its diagonals (the hypotheses of the theorem) and the statement that the point  $N$  bisects the diagonals (the conclusion of the theorem) can be expressed in polynomial form.

The properties of parallelograms are unchanged under translations and rotations in the plane. Hence, we may begin by translating and rotating the parallelogram to place it in any position we like, or equivalently, by choosing our coordinates in any convenient fashion. The simplest way to proceed is as follows. We place the vertex  $A$  at the origin and align the side  $AB$  with the horizontal coordinate axis. In other words, we can take  $A = (0, 0)$  and  $B = (u_1, 0)$  for some  $u_1 \neq 0 \in \mathbb{R}$ . In what follows we will think of  $u_1$  as an indeterminate or variable whose value can be chosen arbitrarily in  $\mathbb{R} - \{0\}$ . The vertex  $C$  of the parallelogram can be at any point  $C = (u_2, u_3)$ , where  $u_2, u_3$  are new indeterminates independent of  $u_1$ , and  $u_3 \neq 0$ . The remaining vertex  $D$  is now completely determined by the choice of  $A, B, C$ .

It will always be true that when constructing the geometric configuration described by a theorem, some of the coordinates of some points will be *arbitrary*, whereas the remaining coordinates of points will be *determined* (possibly up to a finite number of choices) by the arbitrary ones. To indicate arbitrary coordinates, we will consistently use variables  $u_i$ , whereas the other coordinates will be denoted  $x_j$ . It is important to note that this division of coordinates into two subsets is in no way uniquely specified by the hypotheses of the theorem. Different constructions of a figure, for example, may lead to different sets of arbitrary variables and to different translations of the hypotheses into polynomial equations.

Since  $D$  is determined by  $A$ ,  $B$ , and  $C$ , we will write  $D = (x_1, x_2)$ . One hypothesis of our theorem is that the quadrilateral  $ABDC$  is a parallelogram or, equivalently, that the opposite pairs of sides are parallel and, hence, have the same slope. Using the slope formula for a line segment, we see that one translation of these statements is as follows:

$$\begin{aligned} \overline{AB} \parallel \overline{CD} : 0 &= \frac{x_2 - u_3}{x_1 - u_2}, \\ \overline{AC} \parallel \overline{BD} : \frac{u_3}{u_2} &= \frac{x_2}{x_1 - u_1}. \end{aligned}$$

Clearing denominators, we obtain the polynomial equations

$$(1) \quad \begin{aligned} h_1 &= x_2 - u_3 = 0, \\ h_2 &= (x_1 - u_1)u_3 - x_2u_2 = 0. \end{aligned}$$

(Below, we will discuss another way to get equations for  $x_1$  and  $x_2$ .)

Next, we construct the intersection point of the diagonals of the parallelogram. Since the coordinates of the intersection point  $N$  are determined by the other data, we write  $N = (x_3, x_4)$ . Saying that  $N$  is the intersection of the diagonals is equivalent to saying that  $N$  lies on both of the lines  $\overline{AD}$  and  $\overline{BC}$ , or to saying that the triples  $A, N, D$  and  $B, N, C$  are *collinear*. The latter form of the statement leads to the simplest formulation of these hypotheses. Using the slope formula again, we have the following relations:

$$\begin{aligned} A, N, D \text{ collinear} : \frac{x_4}{x_3} &= \frac{u_3}{x_1}, \\ B, N, C \text{ collinear} : \frac{x_4}{x_3 - u_1} &= \frac{u_3}{u_2 - u_1}. \end{aligned}$$

Clearing denominators again, we have the polynomial equations

$$(2) \quad \begin{aligned} h_3 &= x_4x_1 - x_3u_3 = 0, \\ h_4 &= x_4(u_2 - u_1) - (x_3 - u_1)u_3 = 0. \end{aligned}$$

The system of four equations formed from (1) and (2) gives one translation of the hypotheses of our theorem.

The conclusions can be written in polynomial form by using the distance formula for two points in the plane (the Pythagorean Theorem) and squaring:

$$\begin{aligned} AN = ND : x_3^2 + x_4^2 &= (x_3 - x_1)^2 + (x_4 - x_2)^2, \\ BN = NC : (x_3 - u_1)^2 + x_4^2 &= (x_3 - u_2)^2 + (x_4 - u_3)^2. \end{aligned}$$

Cancelling like terms, the conclusions can be written as

$$(3) \quad \begin{aligned} g_1 &= x_1^2 - 2x_1x_3 - 2x_4x_2 + x_2^2 = 0, \\ g_2 &= 2x_3u_1 - 2x_3u_2 - 2x_4u_3 - u_1^2 + u_2^2 + u_3^2 = 0. \end{aligned}$$

Our translation of the theorem states that the two equations in (3) should hold when the hypotheses in (1) and (2) hold.

As we noted earlier, different translations of the hypotheses and conclusions of a theorem are possible. For instance, see Exercise 2 for a different translation of this theorem based on a different construction of the parallelogram (that is, a different collection of arbitrary coordinates). There is also a great deal of freedom in the way that hypotheses can be translated. For example, the way we represented the hypothesis that  $ABDC$  is a parallelogram in (1) is typical of the way a *computer program* might translate these statements, based on a general method for handling the hypothesis  $\overline{AB} \parallel \overline{CD}$ . But there is an alternate translation based on the observation that, from the parallelogram law for vector addition, the coordinate vector of the point  $D$  should simply be the *vector sum* of the coordinate vectors  $B = (u_1, 0)$  and  $C = (u_2, u_3)$ . Writing  $D = (x_1, x_2)$ , this alternate translation would be

$$(4) \quad \begin{aligned} h'_1 &= x_1 - u_1 - u_2 = 0, \\ h'_2 &= x_2 - u_3 = 0. \end{aligned}$$

These equations are much simpler than the ones in (1). If we wanted to design a geometric theorem-prover that could translate the hypothesis “ $ABDC$  is a parallelogram” *directly* (without reducing it to the equivalent form “ $\overline{AB} \parallel \overline{CD}$  and  $\overline{AC} \parallel \overline{BD}$ ”), the translation (4) would be preferable to (1).

Further, we could also use  $h'_2$  to *eliminate* the variable  $x_2$  from the hypotheses and conclusions, yielding an even simpler system of equations. In fact, with complicated geometric constructions, preparatory simplifications of this kind can sometimes be necessary. They often lead to much more tractable systems of equations.

The following proposition lists some of the most common geometric statements that can be translated into polynomial equations.

**Proposition 2.** *Let  $A, B, C, D, E, F$  be points in the plane. Each of the following geometric statements can be expressed by one or more polynomial equations:*

- (i)  $\overline{AB}$  is parallel to  $\overline{CD}$ .
- (ii)  $\overline{AB}$  is perpendicular to  $\overline{CD}$ .
- (iii)  $A, B, C$  are collinear.
- (iv) The distance from  $A$  to  $B$  is equal to the distance from  $C$  to  $D$ :  $AB = CD$ .
- (v)  $C$  lies on the circle with center  $A$  and radius  $AB$ .
- (vi)  $C$  is the midpoint of  $\overline{AB}$ .
- (vii) The acute angle  $\angle ABC$  is equal to the acute angle  $\angle DEF$ .
- (viii)  $\overline{BD}$  bisects the angle  $\angle ABC$ .

**Proof.** General methods for translating statements (i), (iii), and (iv) were illustrated in Example 1; the general cases are exactly the same. Statement (v) is equivalent to  $AC = AB$ . Hence, it is a special case of (iv) and can be treated in the same way. Statement (vi) can be reduced to a conjunction of two statements:  $A, C, B$  are collinear, and  $AC = CB$ . We, thus, obtain two equations from (iii) and (iv). Finally, (ii), (vii), and (viii) are left to the reader in Exercise 4.  $\square$

Exercise 3 gives several other types of statements that can be translated into polynomial equations. We will say that a geometric theorem is *admissible* if both its hypotheses and its conclusions admit translations into polynomial equations. There are always many different equivalent formulations of an admissible theorem; the translation will never be unique.

Correctly translating the hypotheses of a theorem into a system of polynomial equations can be accomplished most readily if we think of *constructing* a figure illustrating the configuration in question point by point. This is exactly the process used in Example 1 and in the following example.

**Example 3.** We will use Proposition 2 to translate the following beautiful result into polynomial equations.

**Theorem (The Circle Theorem of Apollonius).** *Let  $\triangle ABC$  be a right triangle in the plane, with right angle at  $A$ . The midpoints of the three sides and the foot of the altitude drawn from  $A$  to  $\overline{BC}$  all lie on one circle.*

The theorem is illustrated in the following figure:

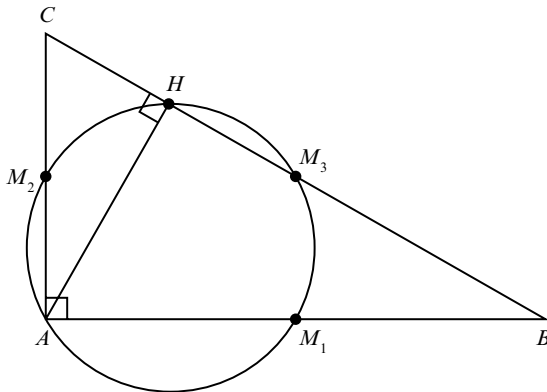

In Exercise 1, you will give a conventional geometric proof of the Circle Theorem. Here we will make the translation to polynomial form, showing that the Circle Theorem is admissible. We begin by constructing the triangle. Placing  $A$  at  $(0,0)$  and  $B$  at  $(u_1, 0)$ , the hypothesis that  $\angle CAB$  is a right angle says  $C = (0, u_2)$ . (Of course, we are taking a shortcut here; we could also make  $C$  a general point and add the hypothesis  $CA \perp AB$ , but that would lead to more variables and more equations.)



Next, we construct the three midpoints of the sides. These points have coordinates  $M_1 = (x_1, 0)$ ,  $M_2 = (0, x_2)$ , and  $M_3 = (x_3, x_4)$ . As in Example 1, we use the convention that  $u_1, u_2$  are to be arbitrary, where as the  $x_j$  are determined by the values of  $u_1, u_2$ . Using part (vi) of Proposition 2, we obtain the equations

$$(5) \quad \begin{aligned} h_1 &= 2x_1 - u_1 = 0, \\ h_2 &= 2x_2 - u_2 = 0, \\ h_3 &= 2x_3 - u_1 = 0, \\ h_4 &= 2x_4 - u_2 = 0. \end{aligned}$$

The next step is to construct the point  $H = (x_5, x_6)$ , the foot of the altitude drawn from  $A$ . We have two hypotheses here:

$$(6) \quad \begin{aligned} AH \perp BC : h_5 &= x_5u_1 - x_6u_2 = 0, \\ B, H, C \text{ collinear} : h_6 &= x_5u_2 + x_6u_1 - u_1u_2 = 0. \end{aligned}$$

Finally, we must consider the statement that  $M_1, M_2, M_3, H$  lie on a circle. A general collection of four points in the plane lies on *no* single circle (this is why the statement of the Circle Theorem is interesting). But *three* noncollinear points always do lie on a circle (the *circumscribed circle* of the triangle they form). Thus, our conclusion can be restated as follows: if we construct the circle containing the noncollinear triple  $M_1, M_2, M_3$ , then  $H$  must lie on *this* circle also. To apply part (v) of Proposition 2, we must know the center of the circle, so this is an additional point that must be constructed. We call the center  $O = (x_7, x_8)$  and derive two additional hypotheses:

$$(7) \quad \begin{aligned} M_1O = M_2O : h_7 &= (x_1 - x_7)^2 + x_8^2 - x_7^2 - (x_8 - x_2)^2 = 0, \\ M_1O = M_3O : h_8 &= (x_1 - x_7)^2 + (0 - x_8)^2 - (x_3 - x_7)^2 - (x_4 - x_8)^2 = 0. \end{aligned}$$

Our conclusion is  $HO = M_1O$ , which takes the form

$$(8) \quad g = (x_5 - x_7)^2 + (x_6 - x_8)^2 - (x_1 - x_7)^2 - x_8^2 = 0.$$

We remark that both here and in Example 1, the number of hypotheses and the number of *dependent* variables  $x_j$  are *the same*. This is typical of properly posed geometric hypotheses. We expect that given values for the  $u_i$ , there should be at most finitely many different combinations of  $x_j$  satisfying the equations.

We now consider the typical form of an admissible geometric theorem. We will have some number of arbitrary coordinates, or independent variables in our construction, denoted by  $u_1, \dots, u_m$ . In addition, there will be some collection of dependent variables  $x_1, \dots, x_n$ . The hypotheses of the theorem will be represented by a collection of polynomial equations in the  $u_i, x_j$ . As we noted in Example 3, it is typical of a properly posed theorem that the number of hypotheses is equal to the number of dependent

variables, so we will write the hypotheses as

$$(9) \quad \begin{aligned} h_1(u_1, \dots, u_m, x_1, \dots, x_n) &= 0, \\ &\vdots \\ h_n(u_1, \dots, u_m, x_1, \dots, x_n) &= 0. \end{aligned}$$

The conclusions of the theorem will also be expressed as polynomials in the  $u_i, x_j$ . It suffices to consider the case of *one* conclusion since if there are more, we can simply treat them one at a time. Hence, we will write the conclusion as

$$g(u_1, \dots, u_m, x_1, \dots, x_n) = 0.$$

The question to be addressed is: how can the fact that  $g$  follows from  $h_1, \dots, h_n$  be deduced *algebraically*? The basic idea is that we want  $g$  to vanish whenever  $h_1, \dots, h_n$  do. We observe that the hypotheses (9) are equations that define a *variety*

$$V = \mathbf{V}(h_1, \dots, h_n) \subset \mathbb{R}^{m+n}.$$

This leads to the following definition.

**Definition 4.** *The conclusion  $g$  follows strictly from the hypotheses  $h_1, \dots, h_n$  if  $g \in \mathbf{I}(V) \subset \mathbb{R}[u_1, \dots, u_m, x_1, \dots, x_n]$ , where  $V = \mathbf{V}(h_1, \dots, h_n)$ .*

Although this definition seems reasonable, we will see later that it is too strict. Most geometric theorems have some “degenerate” cases that Definition 4 does not take into account. But for the time being, we will use the above notion of “follows strictly.”

One drawback of Definition 4 is that because we are working over  $\mathbb{R}$ , we do not have an effective method for determining  $\mathbf{I}(V)$ . But we still have the following useful criterion.

**Proposition 5.** *If  $g \in \sqrt{\langle h_1, \dots, h_n \rangle}$ , then  $g$  follows strictly from  $h_1, \dots, h_n$ .*

**Proof.** The hypothesis  $g \in \sqrt{\langle h_1, \dots, h_n \rangle}$  implies that  $g^s \in \langle h_1, \dots, h_n \rangle$  for some  $s$ . Thus,  $g^s = \sum_{i=1}^n A_i h_i$ , where  $A_i \in \mathbb{R}[u_1, \dots, u_m, x_1, \dots, x_n]$ . Then  $g^s$ , and, hence,  $g$  itself, must vanish whenever  $h_1, \dots, h_n$  do.  $\square$

Note that the converse of this proposition fails whenever  $\sqrt{\langle h_1, \dots, h_n \rangle} \subsetneq \mathbf{I}(V)$ , which can easily happen when working over  $\mathbb{R}$ . Nevertheless, Proposition 5 is still useful because we can test whether  $g \in \sqrt{\langle h_1, \dots, h_n \rangle}$  using the radical membership algorithm from Chapter 4, §2. Let  $\bar{I} = \langle h_1, \dots, h_n, 1 - yg \rangle$  in the ring  $\mathbb{R}[u_1, \dots, u_m, x_1, \dots, x_n, y]$ . Then Proposition 8 of Chapter 4, §2 implies that

$$g \in \sqrt{\langle h_1, \dots, h_n \rangle} \iff \{1\} \text{ is the reduced Groebner basis of } \bar{I}.$$

If this condition is satisfied, then  $g$  follows strictly from  $h_1, \dots, h_n$ .

If we work over  $\mathbb{C}$ , we can get a better sense of what  $g \in \sqrt{\langle h_1, \dots, h_n \rangle}$  means. By allowing solutions in  $\mathbb{C}$ , the hypotheses  $h_1, \dots, h_n$  define a variety  $V_{\mathbb{C}} \subset \mathbb{C}^{m+n}$ . Then,

in Exercise 9, you will use the Strong Nullstellensatz to show that

$$\begin{aligned} g \in \sqrt{\langle h_1, \dots, h_n \rangle} \subset \mathbb{R}[u_1, \dots, u_m, x_1, \dots, x_n] \\ \iff g \in \mathbf{I}(V_{\mathbb{C}}) \subset \mathbb{C}[u_1, \dots, u_m, x_1, \dots, x_n]. \end{aligned}$$

Thus,  $g \in \sqrt{\langle h_1, \dots, h_n \rangle}$  means that  $g$  “follows strictly over  $\mathbb{C}$ ” from  $h_1, \dots, h_n$ .

Let us apply these concepts to an example. This will reveal why Definition 4 is too strong.

**Example 1.** [continued] To see what can go wrong if we proceed as above, consider the theorem on the diagonals of a parallelogram from Example 1, taking as hypotheses the four polynomials from (1) and (2):

$$\begin{aligned} h_1 &= x_2 - u_3, \\ h_2 &= (x_1 - u_1)u_3 - u_2x_2, \\ h_3 &= x_4x_1 - x_3u_3, \\ h_4 &= x_4(u_2 - u_1) - (x_3 - u_1)u_3. \end{aligned}$$

We will take as conclusion the *first* polynomial from (3):

$$g = x_1^2 - 2x_1x_3 - 2x_4x_2 + x_2^2.$$

To apply Proposition 5, we must compute a Groebner basis for

$$\bar{I} = \langle h_1, h_2, h_3, h_4, 1 - yg \rangle \subset \mathbb{R}[u_1, u_2, u_3, x_1, x_2, x_3, x_4, y].$$

Surprisingly enough, we do *not* find  $\{1\}$ . (You will use a computer algebra system in Exercise 10 to verify this.) Since the statement is a true geometric theorem, we must try to understand why our proposed method failed in this case.

The reason can be seen by computing a Groebner basis for  $I = \langle h_1, h_2, h_3, h_4 \rangle$  in  $\mathbb{R}[u_1, u_2, u_3, x_1, x_2, x_3, x_4]$ , using lex order with  $x_1 > x_2 > x_3 > x_4 > u_1 > u_2 > u_3$ . The result is

$$\begin{aligned} f_1 &= x_1x_4 + x_4u_1 - x_4u_2 - u_1u_3, \\ f_2 &= x_1u_3 - u_1u_3 - u_2u_3, \\ f_3 &= x_2 - u_3, \\ f_4 &= x_3u_3 + x_4u_1 - x_4u_2 - u_1u_3, \\ f_5 &= x_4u_1^2 - x_4u_1u_2 - \frac{1}{2}u_1^2u_3 + \frac{1}{2}u_1u_2u_3, \\ f_6 &= x_4u_1u_3 - \frac{1}{2}u_1u_3^2. \end{aligned}$$

The variety  $V = \mathbf{V}(h_1, h_2, h_3, h_4) = \mathbf{V}(f_1, \dots, f_6)$  in  $\mathbb{R}^7$  defined by the hypotheses is actually *reducible*. To see this, note that  $f_2$  factors as  $(x_1 - u_1 - u_2)u_3$ , which implies that

$$V = \mathbf{V}(f_1, x_1 - u_1 - u_2, f_3, f_4, f_5, f_6) \cup \mathbf{V}(f_1, u_3, f_3, f_4, f_5, f_6).$$

Since  $f_5$  and  $f_6$  also factor, we can continue this decomposition process. Things simplify dramatically if we recompute the Groebner basis at each stage, and, in the exercises, you will show that this leads to the decomposition

$$V = V' \cup U_1 \cup U_2 \cup U_3$$

into irreducible varieties, where

$$\begin{aligned} V' &= \mathbf{V}\left(x_1 - u_1 - u_2, x_2 - u_3, x_3 - \frac{u_1 + u_2}{2}, x_4 - \frac{u_3}{2}\right), \\ U_1 &= \mathbf{V}(x_2, x_4, u_3), \\ U_2 &= \mathbf{V}(x_1, x_2, u_1 - u_2, u_3), \\ U_3 &= \mathbf{V}(x_1 - u_2, x_2 - u_3, x_3u_3 - x_4u_2, u_1). \end{aligned}$$

You will also show that none of these varieties are contained in the others, so that  $V', U_1, U_2, U_3$  are the irreducible components of  $V$ .

The problem becomes apparent when we interpret the components  $U_1, U_2, U_3 \subset V$  in terms of the parallelogram  $ABDC$ . On  $U_1$  and  $U_2$ , we have  $u_3 = 0$ . This is troubling since  $u_3$  was supposed to be arbitrary. Further, when  $u_3 = 0$ , the vertex  $C$  of our parallelogram lies on  $\overline{AB}$  and, hence we do not have a parallelogram at all. This is a *degenerate* case of our configuration, which we intended to *rule out* by the hypothesis that  $ABDC$  was an honest parallelogram in the plane. Similarly, we have  $u_1 = 0$  on  $U_3$ , which again is a degenerate configuration.

You can also check that on  $U_1 = \mathbf{V}(x_2, x_4, u_3)$ , our conclusion  $g$  becomes  $g = x_1^2 - 2x_1x_3$ , which is *not* zero since  $x_1$  and  $x_3$  are arbitrary on  $U_1$ . This explains why our first attempt failed to prove the theorem. Once we exclude the degenerate cases  $U_1, U_2, U_3$ , the above method easily shows that  $g$  vanishes on  $V'$ . We leave the details as an exercise.

Our goal is to develop a general method that can be used to decide the validity of a theorem, taking into account any degenerate special cases that may need to be excluded. To begin, we use Theorem 2 of Chapter 4, §6 to write  $V = \mathbf{V}(h_1, \dots, h_n) \subset \mathbb{R}^{m+n}$  as a finite union of irreducible varieties,

$$(10) \quad V = V_1 \cup \dots \cup V_k.$$

As we saw in the continuation of Example 1, it may be the case that some polynomial equation involving *only* the  $u_i$  holds on one or more of these irreducible components of  $V$ . Since our intent is that the  $u_i$  should be essentially independent, we want to *exclude* these components from consideration if they are present. We introduce the following terminology.

**Definition 6.** Let  $W$  be an irreducible variety in the affine space  $\mathbb{R}^{m+n}$  with coordinates  $u_1, \dots, u_m, x_1, \dots, x_n$ . We say that the functions  $u_1, \dots, u_m$  are **algebraically independent on  $W$**  if no nonzero polynomial in the  $u_i$  alone vanishes identically on  $W$ .

Equivalently, Definition 6 states that  $u_1, \dots, u_m$  are algebraically independent on  $W$  if  $\mathbf{I}(W) \cap \mathbb{R}[u_1, \dots, u_m] = \{0\}$ .

Thus, in the decomposition of the variety  $V$  given in (10), we can regroup the irreducible components in the following way:

$$(11) \quad V = W_1 \cup \dots \cup W_p \cup U_1 \cup \dots \cup U_q,$$

where  $u_1, \dots, u_m$  are algebraically independent on the components  $W_i$  and are not algebraically independent on the components  $U_j$ . Thus, the  $U_j$ , represent “degenerate” cases of the hypotheses of our theorem. To ensure that the variables  $u_i$  are actually arbitrary in the geometric configurations we study, we should consider *only* the subvariety

$$V' = W_1 \cup \dots \cup W_p \subset V.$$

Given a conclusion  $g \in \mathbb{R}[u_1, \dots, u_m, x_1, \dots, x_n]$  we want to prove, we are not interested in how  $g$  behaves on the degenerate cases. This leads to the following definition.

**Definition 7.** *The conclusion  $g$  follows generically from the hypotheses  $h_1, \dots, h_n$  if  $g \in \mathbf{I}(V') \subset \mathbb{R}[u_1, \dots, u_m, x_1, \dots, x_n]$ , where, as above,  $V' \subset \mathbb{R}^{m+n}$  is the union of the components of the variety  $V = \mathbf{V}(h_1, \dots, h_n)$  on which the  $u_i$  are algebraically independent.*

Saying a geometric theorem is “true” in the usual sense means precisely that its conclusion(s) follow generically from its hypotheses. The question becomes, given a conclusion  $g$ : Can we determine when  $g \in \mathbf{I}(V')$ ? That is, can we develop a criterion that determines whether  $g$  vanishes on every component of  $V$  on which the  $u_i$  are algebraically independent, ignoring what happens on the possible “degenerate” components?

Determining the decomposition of a variety into irreducible components is not always easy, so we would like a method to determine whether a conclusion follows generically from a set of hypotheses that *does not* require knowledge of the decomposition (11). Further, even if we could find  $V'$ , we would still have the problem of computing  $\mathbf{I}(V')$ .

Fortunately, it is possible to show that  $g$  follows generically from  $h_1, \dots, h_n$  without knowing the decomposition of  $V$  given in (11). We have the following result.

**Proposition 8.** *In the situation described above,  $g$  follows generically from  $h_1, \dots, h_n$  whenever there is some nonzero polynomial  $c(u_1, \dots, u_m) \in \mathbb{R}[u_1, \dots, u_m]$  such that*

$$c \cdot g \in \sqrt{H},$$

where  $H$  is the ideal generated by the hypotheses  $h_i$  in  $\mathbb{R}[u_1, \dots, u_m, x_1, \dots, x_n]$ .

**Proof.** Let  $V_j$  be one of the irreducible components of  $V'$ . Since  $c \cdot g \in \sqrt{H}$ , we see that  $c \cdot g$  vanishes on  $V$  and, hence, on  $V_j$ . Thus, the product  $c \cdot g$  is in  $\mathbf{I}(V_j)$ . But  $V_j$  is irreducible, so that  $\mathbf{I}(V_j)$  is a prime ideal by Proposition 3 of Chapter 4, §5. Thus,

$c \cdot g \in \mathbf{I}(V_j)$  implies either  $c$  or  $g$  is in  $\mathbf{I}(V_j)$ . We know  $c \notin \mathbf{I}(V_j)$  since no nonzero polynomial in the  $u_i$  alone vanishes on this component. Hence,  $g \in \mathbf{I}(V_j)$ , and since this is true for each component of  $V'$ , it follows that  $g \in \mathbf{I}(V')$ .  $\square$

For Proposition 8 to give a practical way of determining whether a conclusion follows generically from a set of hypotheses, we need a criterion for deciding when there is a nonzero polynomial  $c$  with  $c \cdot g \in \sqrt{H}$ . This is actually quite easy to do. By the definition of the radical, we know that  $c \cdot g \in \sqrt{H}$  if and only if

$$(c \cdot g)^s = \sum_{j=1}^n A_j h_j$$

for some  $A_j \in \mathbb{R}[u_1, \dots, u_m, x_1, \dots, x_n]$  and  $s \geq 1$ . If we divide both sides of this equation by  $c^s$ , we obtain

$$g^s = \sum_{j=1}^n \frac{A_j}{c^s} h_j,$$

which shows that  $g$  is in the radical of the ideal  $\tilde{H}$  generated by  $h_1, \dots, h_n$  over the ring  $\mathbb{R}(u_1, \dots, u_m)[x_1, \dots, x_n]$  (in which we allow denominators depending only on the  $u_i$ ). Conversely, if  $g \in \sqrt{\tilde{H}}$ , then

$$g^s = \sum_{j=1}^n B_j h_j,$$

where the  $B_j \in \mathbb{R}(u_1, \dots, u_m)[x_1, \dots, x_n]$ . If we find a least common denominator  $c$  for all terms in all the  $B_j$  and multiply both sides by  $c^s$  (clearing denominators in the process), we obtain

$$(c \cdot g)^s = \sum_{j=1}^n B'_j h_j,$$

where  $B'_j \in \mathbb{R}[u_1, \dots, u_m, x_1, \dots, x_n]$  and  $c$  depends only on the  $u_i$ . As a result,  $c \cdot g \in \sqrt{H}$ . These calculations and the radical membership algorithm from §2 of Chapter 4 establish the following corollary of Proposition 8.

**Corollary 9.** *In the situation of Proposition 8, the following are equivalent:*

- (i) *There is a nonzero polynomial  $c \in \mathbb{R}[u_1, \dots, u_m]$  such that  $c \cdot g \in \sqrt{H}$ .*
- (ii)  *$g \in \sqrt{\tilde{H}}$ , where  $\tilde{H}$  is the ideal generated by the  $h_j$  in  $\mathbb{R}(u_1, \dots, u_m)[x_1, \dots, x_n]$ .*
- (iii) *{1} is the reduced Groebner basis of the ideal*

$$\langle h_1, \dots, h_n, 1 - yg \rangle \subset \mathbb{R}(u_1, \dots, u_m)[x_1, \dots, x_n, y].$$

If we combine part (iii) of this corollary with Proposition 8, we get an algorithmic method for proving that a conclusion follows generically from a set of hypotheses. We will call this the Groebner basis method in geometric theorem proving.

To illustrate the use of this method, we will consider the theorem on parallelograms from Example 1 once more. We compute a Groebner basis of  $\langle h_1, h_2, h_3, h_4, 1 - yg \rangle$  in the ring  $\mathbb{R}(u_1, u_2, u_3)[x_1, x_2, x_3, x_4, y]$ . This computation *does yield*  $\{1\}$  as we expect. Making  $u_1, u_2, u_3$  invertible by passing to  $\mathbb{R}(u_1, u_2, u_3)$  as our field of coefficients in effect *removes* the degenerate cases encountered above, and the conclusion *does* follow generically from the hypotheses. Moreover, in Exercise 12, you will see that  $g$  itself (and not some higher power) actually lies in  $\langle h_1, h_2, h_3, h_4 \rangle \subset \mathbb{R}(u_1, u_2, u_3)[x_1, x_2, x_3, x_4]$ .

Note that the Groebner basis method does not tell us what the degenerate cases are. The information about these cases is contained in the polynomial  $c \in \mathbb{R}[u_1, \dots, u_m]$ , for  $c \cdot g \in \sqrt{H}$  tells us that  $g$  follows from  $h_1, \dots, h_n$  whenever  $c$  does not vanish (this is because  $c \cdot g$  vanishes on  $V$ ). In Exercise 14, we will give an algorithm for finding  $c$ .

Over  $\mathbb{C}$ , we can think of Corollary 9 in terms of the variety  $V_{\mathbb{C}} = \mathbf{V}(h_1, \dots, h_n) \subset \mathbb{C}^{m+n}$  as follows. Decomposing  $V_{\mathbb{C}}$  as in (11), let  $V'_{\mathbb{C}} \subset V_{\mathbb{C}}$  be the union of those components where the  $u_i$  are algebraically independent. Then Exercise 15 will use the Nullstellensatz to prove that

$$\begin{aligned} \exists c \neq 0 \text{ in } \mathbb{R}[u_1, \dots, u_m] \text{ with } c \cdot g \in \sqrt{\langle h_1, \dots, h_n \rangle} \subset \mathbb{R}[u_1, \dots, u_m, x_1, \dots, x_n] \\ \iff g \in \mathbf{I}(V'_{\mathbb{C}}) \subset \mathbb{C}[u_1, \dots, u_m, x_1, \dots, x_n]. \end{aligned}$$

Thus, the conditions of Corollary 9 mean that  $g$  “follows generically over  $\mathbb{C}$ ” from the hypotheses  $h_1, \dots, h_n$ .

This interpretation points out what is perhaps the main limitation of the Groebner basis method in geometric theorem proving: it can only prove theorems where the conclusions follow generically over  $\mathbb{C}$ , even though we are only interested in what happens over  $\mathbb{R}$ . In particular, there are theorems which are true over  $\mathbb{R}$  but not over  $\mathbb{C}$  [see STURMFELS (1989) for an example]. Our methods will fail for such theorems.

When using Corollary 9, it is often unnecessary to consider the radical of  $\tilde{H}$ . In many cases, the first power of the conclusion is in  $\tilde{H}$  already. So most theorem proving programs in effect use an *ideal* membership algorithm first to test if  $g \in \tilde{H}$ , and only go on to the radical membership test if that initial step fails.

To illustrate this, we continue with the Circle Theorem of Apollonius from Example 3. Our hypotheses are the eight polynomials  $h_i$  from (5)–(7). We begin by computing a Groebner basis (using lex order) for the ideal  $\tilde{H}$ , which yields

$$\begin{aligned} f_1 &= x_1 - u_1/2, \\ f_2 &= x_2 - u_2/2, \\ f_3 &= x_3 - u_1/2, \\ f_4 &= x_4 - u_2/2, \\ f_5 &= x_5 - \frac{u_1 u_2^2}{u_1^2 + u_2^2}, \\ f_6 &= x_6 - \frac{u_1^2 u_2}{u_1^2 + u_2^2}, \\ f_7 &= x_7 - u_1/4, \\ f_8 &= x_8 - u_2/4. \end{aligned} \tag{12}$$

We leave it as an exercise to show that the conclusion (8) reduces to zero on division by this Groebner basis. Thus,  $g$  itself is in  $\bar{H}$ , which shows that  $g$  follows generically from  $h_1, \dots, h_8$ . Note that we must have either  $u_1 \neq 0$  or  $u_2 \neq 0$  in order to solve for  $x_5$  and  $x_6$ . The equations  $u_1 = 0$  and  $u_2 = 0$  describe degenerate right “triangles” in which the three vertices are not distinct, so we certainly wish to rule these cases out. It is interesting to note, however, that if either  $u_1$  or  $u_2$  is nonzero, the conclusion is still true. For instance, if  $u_1 \neq 0$  but  $u_2 = 0$ , then the vertices  $C$  and  $A$  coincide. From (5) and (6), the midpoints  $M_1$  and  $M_3$  coincide,  $M_2$  coincides with  $A$ , and  $H$  coincides with  $A$  as well. As a result, there *is* a circle (infinitely many of them in fact) containing  $M_1, M_2, M_3$ , and  $H$  in this degenerate case. In Exercise 16, you will study what happens when  $u_1 = u_2 = 0$ .

We conclude this section by noting that there is one further subtlety that can occur when we use this method to prove or verify a theorem. Namely, there are cases where the given statement of a geometric theorem conceals one or more unstated “extra” hypotheses. These may very well not be included when we make a direct translation to a system of polynomial equations. This often results in a situation where the variety  $V'$  is *reducible* or, equivalently, where  $p \geq 2$  in (11). In this case, it may be true that the intended conclusion is zero *only* on some of the reducible components of  $V'$ , so that any method based on Corollary 9 would fail. We will study an example of this type in Exercise 17. If this happens, we may need to reformulate our hypotheses to exclude the extraneous, unwanted components of  $V'$ .

#### EXERCISES FOR §4

1. This exercise asks you to give geometric proofs of the theorems that we studied in Examples 1 and 3.
  - a. Give a standard Euclidean proof of the theorem of Example 1. Hint: Show  $\triangle ANC \cong \triangle BND$ .
  - b. Give a standard Euclidean proof of the Circle Theorem of Apollonius from Example 3. Hint: First show that  $\overline{AB}$  and  $\overline{M_2M_3}$  are parallel.
2. This exercise shows that it is possible to give translations of a theorem based on different collections of arbitrary coordinates. Consider the parallelogram  $ABDC$  from Example 1 and begin by placing  $A$  at the origin.
  - a. Explain why it is also possible to consider both of the coordinates of  $D$  as arbitrary variables:  $D = (u_1, u_2)$ .
  - b. With this choice, explain why we can specify the coordinates of  $B$  as  $B = (u_3, x_1)$ . That is, the  $x$ -coordinate of  $B$  is arbitrary, but the  $y$ -coordinate is determined by the choices of  $u_1, u_2, u_3$ .
  - c. Complete the translation of the theorem based on this choice of coordinates.
3. Let  $A, B, C, D, E, F, G, H$  be points in the plane.
  - a. Show that the statement  $\overline{AB}$  is tangent to the circle through  $A, C, D$  can be expressed by polynomial equations. Hint: Construct the center of the circle first. Then, what is true about the tangent and the radius of a circle at a given point?
  - b. Show that the statement  $AB \cdot CD = EF \cdot GH$  can be expressed by one or more polynomial equations.
  - c. Show that the statement  $\frac{AB}{CD} = \frac{EF}{GH}$  can be expressed by one or more polynomial equations.



- d. The *cross ratio* of the ordered 4-tuple of distinct *collinear* points  $(A, B, C, D)$  is defined to be the real number

$$\frac{AC \cdot BD}{AD \cdot BC}.$$

Show that the statement “The cross ratio of  $(A, B, C, D)$  is equal to  $\rho \in \mathbb{R}$ ” can be expressed by one or more polynomial equations.

4. In this exercise, you will complete the proof of Proposition 2 in the text.
  - a. Prove part (ii).
  - b. Show that if  $\alpha, \beta$  are acute angles, then  $\alpha = \beta$  if and only if  $\tan \alpha = \tan \beta$ . Use this fact and part (c) of Exercise 3 to prove part (vii) of Proposition 2. Hint: To compute the tangent of an angle, you can construct an appropriate right triangle and compute a ratio of side lengths.
  - c. Prove part (viii).
5. Let  $\triangle ABC$  be a triangle in the plane. Recall that the *altitude* from  $A$  is the line segment from  $A$  meeting the opposite side  $\overline{BC}$  at a right angle. (We may have to extend  $\overline{BC}$  here to find the intersection point.) A standard geometric theorem asserts that the three altitudes of a triangle meet at a single point  $H$ , often called the *orthocenter* of the triangle. Give a translation of the hypotheses and conclusion of this theorem as a system of polynomial equations.
6. Let  $\triangle ABC$  be a triangle in the plane. It is a standard theorem that if we let  $M_1$  be the midpoint of  $\overline{BC}$ ,  $M_2$  be the midpoint of  $\overline{AC}$  and  $M_3$  be the midpoint of  $\overline{AB}$ , then the segments  $\overline{AM_1}$ ,  $\overline{BM_2}$  and  $\overline{CM_3}$  meet at a single point  $M$ , often called the *centroid* of the triangle. Give a translation of the hypotheses and conclusion of this theorem as a system of polynomial equations.
7. Let  $\triangle ABC$  be a triangle in the plane. It is a famous theorem of Euler that the *circumcenter* (the center of the circumscribed circle), the *orthocenter* (from Exercise 5), and the *centroid* (from Exercise 6) are always *collinear*. Translate the hypotheses and conclusion of this theorem into a system of polynomial equations. (The line containing the three “centers” of the triangle is called the *Euler line* of the triangle.)
8. A beautiful theorem ascribed to Pappus concerns two collinear triples of points  $A, B, C$  and  $A', B', C'$ . Let

$$\begin{aligned} P &= \overline{AB'} \cap \overline{A'B}, \\ Q &= \overline{AC'} \cap \overline{A'C}, \\ R &= \overline{BC'} \cap \overline{B'C} \end{aligned}$$

be as in the figure:

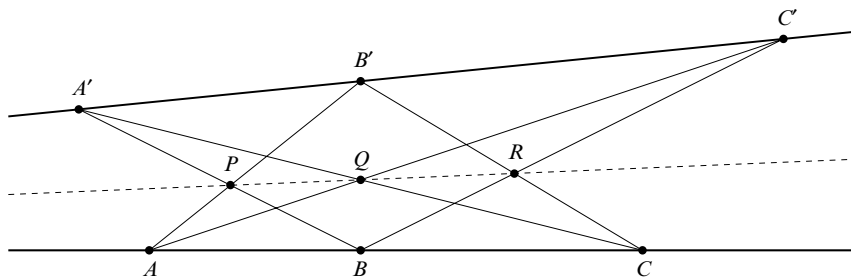

Then it is always the case that  $P, Q, R$  are collinear points. Give a translation of the hypotheses and conclusion of this theorem as a system of polynomial equations.

9. Given  $h_1, \dots, h_n \in \mathbb{R}[u_1, \dots, u_m, x_1, \dots, x_n]$ , let  $V_{\mathbb{C}} = \mathbf{V}(h_1, \dots, h_n) \subset \mathbb{C}^{m+n}$ . If  $g \in \mathbb{R}[u_1, \dots, u_m, x_1, \dots, x_n]$ , the goal of this exercise is to prove that

$$g \in \sqrt{\langle h_1, \dots, h_n \rangle} \subset \mathbb{R}[u_1, \dots, u_m, x_1, \dots, x_n] \\ \iff g \in \mathbf{I}(V_{\mathbb{C}}) \subset \mathbb{C}[u_1, \dots, u_m, x_1, \dots, x_n].$$

- a. Prove the  $\implies$  implication.
  - b. Use the Strong Nullstellensatz to show that if  $g \in \mathbf{I}(V_{\mathbb{C}})$ , then there are polynomials  $A_j \in \mathbb{C}[u_1, \dots, u_m, x_1, \dots, x_n]$  such that  $g^s = \sum_{j=1}^n A_j h_j$  for some  $s \geq 1$ .
  - c. Explain why  $A_j$  can be written  $A_j = A'_j + iA''_j$ , where  $A'_j, A''_j$  are polynomials with real coefficients. Use this to conclude that  $g^s = \sum_{j=1}^n a'_j h_j$ , which will complete the proof of the  $\impliedby$  implication. Hint:  $g$  and  $h_1, \dots, h_n$  have real coefficients.
10. Verify the claim made in Example 1 that  $\{1\}$  is not the unique reduced Groebner basis for the ideal  $\bar{I} = \langle h_1, h_2, h_3, h_4, 1 - yg \rangle$ .
11. This exercise will study the decomposition into reducible components of the variety defined by the hypotheses of the theorem from Example 1.
- a. Verify the claim made in the continuation of Example 1 that

$$V = \mathbf{V}(f_1, x_1 - u_1 - u_2, f_3, \dots, f_6) \cup \mathbf{V}(f_1, u_3, f_3, \dots, f_6) = V_1 \cup V_2.$$

- b. Compute Groebner bases for the defining equations of  $V_1$  and  $V_2$ . Some of the polynomials should factor and use this to decompose  $V_1$  and  $V_2$ .
  - c. By continuing this process, show that  $V$  is the union of the varieties  $V', U_1, U_2, U_3$  defined in the text.
  - d. Prove that  $V', U_1, U_2, U_3$  are irreducible and that none of them are contained in the union of the others. This shows that  $V', U_1, U_2, U_3$  are the reducible components of  $V$ .
  - e. On which irreducible component of  $V$  is the conclusion of the theorem valid?
  - f. Suppose we take as hypotheses the four polynomials in (4) and (2). Is  $W = \mathbf{V}(h'_1, h'_2, h_3, h_4)$  reducible? How many components does it have?
12. Verify the claim made in Example 1 that the conclusion  $g$  itself (and not some higher power) is in the ideal generated by  $h_1, h_2, h_3, h_4$  in  $\mathbb{R}(u_1, u_2, u_3)[x_1, x_2, x_3, x_4]$ .
13. By applying part (iii) of Corollary 9, verify that  $g$  follows generically from the  $h_j$  for each of the following theorems. What is the lowest power of  $g$  which is contained in the ideal  $\bar{H}$  in each case?
- a. the theorem on the orthocenter of a triangle (Exercise 5),
  - b. the theorem on the centroid of a triangle (Exercise 6),
  - c. the theorem on the Euler line of a triangle (Exercise 7),
  - d. Pappus's Theorem (Exercise 8).
14. In this exercise, we will give an algorithm for finding a nonzero  $c \in \mathbb{R}[u_1, \dots, u_m]$  such that  $c \cdot g \in \sqrt{\bar{H}}$ , assuming that such a  $c$  exists. We will work with the ideal

$$\bar{H} = \langle h_1, \dots, h_n, 1 - yg \rangle \subset \mathbb{R}[u_1, \dots, u_m, x_1, \dots, x_n, y].$$

- a. Show that the conditions of Corollary 9 are equivalent to  $\bar{H} \cap \mathbb{R}[u_1, \dots, u_m] \neq \{0\}$ . Hint: Use condition (iii) of the corollary.
- b. If  $c \in \bar{H} \cap \mathbb{R}[u_1, \dots, u_m]$ , prove that  $c \cdot g \in \sqrt{\bar{H}}$ . Hint: Adapt the argument used in equations (2)–(4) in the proof of Hilbert's Nullstellensatz in Chapter 4, §1.
- c. Describe an algorithm for computing  $\bar{H} \cap \mathbb{R}[u_1, \dots, u_m]$ . For maximum efficiency, what monomial order should you use?

Parts (a)–(c) give an algorithm which decides if there is a nonzero  $c$  with  $c \cdot g \in \sqrt{H}$  and *simultaneously* produces the required  $c$ . Parts (d) and (e) below give some interesting properties of the ideal  $\overline{H} \cap \mathbb{R}[u_1, \dots, u_m]$ .

d. Show that if the conclusion  $g$  fails to hold for some choice of  $u_1, \dots, u_m$ , then  $(u_1, \dots, u_m) \in W = \mathbf{V}(\overline{H} \cap \mathbb{R}[u_1, \dots, u_m]) \subset \mathbb{R}^m$ . Thus,  $W$  records the degenerate cases where  $g$  fails.

e. Show that  $\sqrt{\overline{H} \cap \mathbb{R}[u_1, \dots, u_m]}$  gives all  $c$ 's for which  $c \cdot g \in \sqrt{H}$ . Hint: One direction follows from part (a). If  $c \cdot g \in \sqrt{H}$ , note the  $\overline{H}$  contains  $(c \cdot g)$ 's and  $1 - gy$ . Now adapt the argument given in Proposition 8 of Chapter 4, §2 to show that  $c^2 \in \overline{H}$ .

15. As in Exercise 9, suppose that we have  $h_1, \dots, h_n \in \mathbb{R}[u_1, \dots, u_m, x_1, \dots, x_n]$ . Then we get  $V_{\mathbb{C}} = \mathbf{V}(h_1, \dots, h_n) \subset \mathbb{C}^{m+n}$ . As we did with  $V$ , let  $V'_{\mathbb{C}}$  be the union of the irreducible components of  $V_{\mathbb{C}}$  where  $u_1, \dots, u_n$  are algebraically independent. Given  $g \in \mathbb{R}[u_1, \dots, u_m, x_1, \dots, x_n]$ , we want to show that

$$\begin{aligned} \exists c \neq 0 \text{ in } \mathbb{R}[u_1, \dots, u_m] \text{ with } c \cdot g \in \sqrt{\langle h_1, \dots, h_n \rangle} \subset \mathbb{R}[u_1, \dots, u_m, x_1, \dots, x_n] \\ \iff g \in \mathbf{I}(V'_{\mathbb{C}}) \subset \mathbb{C}[u_1, \dots, u_m, x_1, \dots, x_n]. \end{aligned}$$

a. Prove the  $\Rightarrow$  implication. Hint: See the proof of Proposition 8.  
 b. Show that if  $g \in \mathbf{I}(V'_{\mathbb{C}})$ , then there is a nonzero polynomial  $c \in \mathbb{C}[u_1, \dots, u_m]$  such that  $c \cdot g \in \mathbf{I}(V_{\mathbb{C}})$ . Hint: Write  $V_{\mathbb{C}} = V'_{\mathbb{C}} \cup U'_1 \cup \dots \cup U'_q$ , where  $u_1, \dots, u_m$  are algebraically dependent on each  $U'_j$ . This means there is a nonzero polynomial  $c_j \in \mathbb{C}[u_1, \dots, u_m]$  which vanishes on  $U'_j$ .

c. Show that the polynomial  $c$  of part b can be chosen to have real coefficients. Hint: If  $\bar{c}$  is the polynomial obtained from  $c$  by taking the complex conjugates of the coefficients, show that  $\bar{c}$  has real coefficients.

d. Once we have  $c \in \mathbb{R}[u_1, \dots, u_m]$  with  $c \cdot g \in \mathbf{I}(V_{\mathbb{C}})$ , use Exercise 9 to complete the proof of the  $\Leftarrow$  implication.

16. This exercise deals with the Circle Theorem of Apollonius from Example 3.

a. Show that the conclusion (8) reduces to 0 on division by the Groebner basis (12) given in the text.

b. Discuss the case  $u_1 = u_2 = 0$  in the Circle Theorem. Does the conclusion follow in this degenerate case?

c. Note that in the diagram in the text illustrating the Circle Theorem, the circle is shown passing through the vertex  $A$  in addition to the three midpoints and the foot of the altitude drawn from  $A$ . Does this conclusion also follow from the hypotheses?

17. In this exercise, we will study a case where a direct translation of the hypotheses of a “true” theorem leads to extraneous components on which the conclusion is actually false. Let  $\Delta ABC$  be a triangle in the plane. We construct three new points  $A', B', C'$  such that the triangles  $\Delta A'BC, \Delta AB'C, \Delta ABC'$  are equilateral. The intended construction is illustrated in the figure on the next page.

Our theorem is that the three line segments  $\overline{AA'}, \overline{BB'}, \overline{CC'}$  all meet in a single point  $S$ . (We call  $S$  the Steiner point or Fermat point of the triangle. If no angle of the original triangle was greater than  $\frac{2\pi}{3}$ , it can be shown that the three segments  $\overline{AS}, \overline{BS}, \overline{CS}$  form the network of shortest total length connecting the points  $A, B, C$ .)

a. Give a conventional geometric proof of the theorem, assuming the construction is done as in the figure.

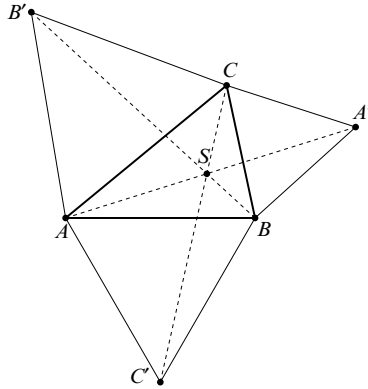

- b. Now, translate the hypotheses and conclusion of this theorem directly into a set of polynomial equations.
- c. Apply the test based on Corollary 9 to determine whether the conclusion follows generically from the hypotheses. The test should fail. Note: This computation may require a *great* deal of ingenuity to push through on some computer algebra systems. This is a complicated system of polynomials.
- d. (The key point) Show that there are other ways to construct a figure which is consistent with the hypotheses *as stated*, but which do not agree with the figure above. Hint: Are the points  $A'$ ,  $B'$ ,  $C'$  uniquely determined by the hypotheses as stated? Is the statement of the theorem valid for these alternate constructions of the figure? Use this to explain why part c did not yield the expected result. (These alternate constructions correspond to points in different components of the variety defined by the hypotheses.)
- e. How can the hypotheses of the theorem be reformulated to exclude the extraneous components?

## §5 Wu's Method

In this section, we will study a second commonly used algorithmic method for proving theorems in Euclidean geometry based on systems of polynomial equations. This method, introduced by the Chinese mathematician Wu Wen-Tsün, was developed *before* the Groebner basis method given in §4. It is also more commonly used than the Groebner basis method in practice because it is usually more efficient.

Both the elementary version of Wu's method that we will present, and the more refined versions, use an interesting variant of the division algorithm for multivariable polynomials introduced in Chapter 2, §3. The idea here is to follow the one-variable polynomial division algorithm as closely as possible, and we obtain a result known as the *pseudodivision* algorithm. To describe the first step in the process, we consider two polynomials in the ring  $k[x_1, \dots, x_n, y]$ , written in the form

$$(1) \quad \begin{aligned} f &= c_p y^p + \dots + c_1 y + c_0, \\ g &= d_m y^m + \dots + d_1 y + d_0, \end{aligned}$$

where the coefficients  $c_i, d_j$  are polynomials in  $x_1, \dots, x_n$ . Assume that  $m \leq p$ . Proceeding as in the one-variable division algorithm for polynomials in  $y$ , we can attempt to remove the leading term  $c_p y^p$  in  $f$  by subtracting a multiple of  $g$ . However, this is not possible directly unless  $d_m$  divides  $c_p$  in  $k[x_1, \dots, x_n]$ . In pseudodivision, we first multiply  $f$  by  $d_m$  to ensure that the leading coefficient is divisible by  $d_m$ , then proceed as in one-variable division. We can state the algorithm formally as follows.

**Proposition 1.** Let  $f, g \in k[x_1, \dots, x_n, y]$  be as in (1) and assume  $m \leq p$  and  $g \neq 0$ .

(i) There is an equation

$$d_m^s f = qg + r,$$

where  $q, r \in k[x_1, \dots, x_n, y]$ ,  $s \geq 0$ , and either  $r = 0$  or the degree of  $r$  in  $y$  is less than  $m$ .

(ii)  $r \in \langle f, g \rangle$  in the ring  $k[x_1, \dots, x_n, y]$ .

**Proof.** (i) Polynomials  $q, r$  satisfying the conditions of the proposition can be constructed by the following algorithm, called *pseudodivision with respect to  $y$* . We use the notation  $\deg(h, y)$  for the degree of the polynomial  $h$  in the variable  $y$  and  $LC(h, y)$  for the leading coefficient of  $h$  as a polynomial in  $y$ —that is, the coefficient of  $y^{\deg(h, y)}$  in  $h$ .

Input:  $f, g$

Output:  $q, r$

$r := f; q := 0$

WHILE  $r \neq 0$  AND  $\deg(r, y) \geq m$  DO

$r := d_m r - LC(r, y)g y^{\deg(r, y) - m}$

$q := d_m q + LC(r, y)y^{\deg(r, y) - m}$

Note that if we follow this procedure, the body of the WHILE loop will be executed at most  $p - m + 1$  times. Thus, the power  $s$  in  $d_m^s f = qg + r$  can be chosen so that  $s \leq p - m + 1$ . We leave the rest of the proof, and the consideration of whether  $q, r$  are unique, to the reader as Exercise 1.

From  $d_m^s f = qg + r$ , it follows that  $r = d_m^s f - qg \in \langle f, g \rangle$ , which completes the proof of the proposition.  $\square$

The polynomials  $q, r$  are known as a *pseudoquotient* and a *pseudoremainder* of  $f$  on pseudodivision by  $g$ , with respect to the variable  $y$ . We will use the notation  $\text{Rem}(f, g, y)$  for the pseudoremainder produced by the algorithm given in the proof of Proposition 1. For example, if we pseudodivide  $f = x^2 y^3 - y$  by  $g = x^3 y - 2$  with respect to  $y$  by the algorithm above, we obtain the equation

$$(x^3)^3 f = (x^8 y^2 + 2x^5 y + 4x^2 - x^6)g + 8x^2 - 2x^6.$$

In particular, the pseudoremainder is  $\text{Rem}(f, g, y) = 8x^2 - 2x^6$ .

We note that there is a second, “slicker” way to understand what is happening in this algorithm. The same idea of *allowing denominators* that we exploited in §4 shows that pseudodivision is the same as

- ordinary one-variable polynomial division for polynomials in  $y$ , with coefficients in the rational function field  $K = k(x_1, \dots, x_n)$ , followed by
- clearing denominators. You will establish this claim in Exercise 2, based on the observation that the only term that needs to be inverted in division of polynomials in  $K[y]$  ( $K$  any field) is the *leading coefficient*  $d_m$  of the divisor  $g$ . Thus, the denominators introduced in the process of dividing  $f$  by  $g$  can all be cleared by multiplying by a suitable power  $d_m^s$ , and we get an equation of the form  $d_m^s f = qg + r$ .

In this second form, or directly, pseudodivision can be readily implemented in most computer algebra systems. Indeed, some systems include pseudodivision as one of the built-in operations on polynomials.

We recall the situation studied in §4, in which the hypotheses and conclusion of a theorem in Euclidean plane geometry are translated into a system of polynomials in variables  $u_1, \dots, u_m, x_1, \dots, x_n$ , with  $h_1, \dots, h_n$  representing the hypotheses and  $g$  giving the conclusion. As in equation (11) of §4, we can group the irreducible components of the variety  $V = \mathbf{V}(h_1, \dots, h_n) \subset \mathbb{R}^{m+n}$  as

$$V = V' \cup U,$$

where  $V'$  is the union of the components on which the  $u_i$  are algebraically independent. Our goal is to prove that  $g$  vanishes on  $V'$ .

The elementary version of Wu's method that we will discuss is tailored for the case where  $V'$  is *irreducible*. We note, however, that Wu's method can be extended to the more general reducible case also. The main algebraic tool needed (Ritt's decomposition algorithm based on *characteristic sets* for prime ideals) would lead us too far afield, though, so we will not discuss it. Note that, in practice, we usually do not know in advance whether  $V'$  is irreducible or not. Thus, reliable “theorem-provers” based on Wu's method should include these more general techniques too.

Our simplified version of Wu's method uses the pseudodivision algorithm in *two* ways in the process of determining whether the equation  $g = 0$  follows from  $h_j = 0$ .

- Step 1 of Wu's method uses pseudodivision to reduce the hypotheses to a system of polynomials  $f_j$  that are in triangular form in the variables  $x_1, \dots, x_n$ . That is, we seek

$$\begin{aligned}
 f_1 &= f_1(u_1, \dots, u_m, x_1), \\
 f_2 &= f_2(u_1, \dots, u_m, x_1, x_2), \\
 &\vdots \\
 f_n &= f_n(u_1, \dots, u_m, x_1, \dots, x_n)
 \end{aligned}
 \tag{2}$$

such that  $\mathbf{V}(f_1, \dots, f_n)$  again contains the irreducible variety  $V'$ , on which the  $u_i$  are algebraically independent.

- Step 2 of Wu’s method uses *successive* pseudodivision of the conclusion  $g$  with respect to each of the variables  $x_j$  to determine whether  $g \in \mathbf{I}(V')$ . We compute

$$\begin{aligned}
 R_{n-1} &= \text{Rem}(g, f_n, x_n), \\
 R_{n-2} &= \text{Rem}(R_{n-1}, f_{n-1}, x_{n-1}), \\
 &\vdots \\
 R_1 &= \text{Rem}(R_2, f_2, x_2), \\
 R_0 &= \text{Rem}(R_1, f_1, x_1).
 \end{aligned}
 \tag{3}$$

- Then  $R_0 = 0$  implies that  $g$  follows from the hypotheses  $h_j$  under an additional condition, to be made precise in Theorem 4.

To explain how Wu’s method works, we need to explain each of these steps, beginning with the reduction to triangular form.

### Step 1. Reduction to Triangular Form

In practice, this reduction can almost always be accomplished using a procedure very similar to Gaussian elimination for systems of linear equations. We will not state any general theorems concerning our procedure, however, because there are some exceptional cases in which it might fail. (See the comments in 3 and 4 below.) A completely general procedure for accomplishing this kind of reduction may be found in CHOU (1988).

The elementary version is performed as follows. We work one variable at a time, beginning with  $x_n$ .

1. Among the  $h_j$ , find all the polynomials containing the variable  $x_n$ . Call the set of such polynomials  $S$ . (If there are no such polynomials, the translation of our geometric theorem is most likely incorrect since it would allow  $x_n$  to be arbitrary.)
2. If there is only one polynomial in  $S$ , then we can rename the polynomials, making that one polynomial  $f'_n$ , and our system of polynomials will have the form

$$\begin{aligned}
 f'_1 &= f'_1(u_1, \dots, u_m, x_1, \dots, x_{n-1}), \\
 &\vdots \\
 f'_{n-1} &= f'_{n-1}(u_1, \dots, u_m, x_1, \dots, x_{n-1}), \\
 f'_n &= f'_n(u_1, \dots, u_m, x_1, \dots, x_n).
 \end{aligned}
 \tag{4}$$

3. If there is more than one polynomial in  $S$ , but some element of  $S$  has degree 1 in  $x_n$ , then we can take  $f'_n$  as that polynomial and replace all the other hypotheses in  $S$  by their pseudoremainders on division by  $f'_n$  with respect to  $x_n$ . [One of these pseudoremainders could conceivably be *zero*, but this would mean that  $f'_n$  would divide  $d^s h$ , where  $h$  is one of the other hypothesis polynomials and  $d = LC(f'_n, x_n)$ . This is unlikely since  $V'$  is assumed to be irreducible.] We obtain a system in the form (4) again. By part (ii) of Proposition 1, all the  $f'_j$  are in the ideal generated by the  $h_j$ .

4. If there are several polynomials in  $S$ , but none has degree 1, then we repeat the steps:

- a. pick  $a, b \in S$  where  $0 < \deg(b, x_n) \leq \deg(a, x_n)$ ;
- b. compute the pseudoremainder  $r = \text{Rem}(a, b, x_n)$ ;
- c. replace  $S$  by  $(S - \{a\}) \cup \{r\}$  (leaving the hypotheses not in  $S$  unchanged),

until eventually we are reduced to a system of polynomials of the form (4) again. Since the degree in  $x_n$  are reduced each time we compute a pseudoremainder, we will eventually remove the  $x_n$  terms from all but one of our polynomials. Moreover, by part (ii) of Proposition 1, each of the resulting polynomials is contained in the ideal generated by the  $h_j$ . Again, it is conceivable that we could obtain a zero pseudoremainder at some stage here. This would usually, but not always, imply reducibility, so it is unlikely. We then apply the same process to the polynomials  $f'_1, \dots, f'_{n-1}$  in (4) to remove the  $x_{n-1}$  terms from all but one polynomial. Continuing in this way, we will eventually arrive at a system of equations in triangular form as in (2) above.

Once we have the triangular equations, we can relate them to the original hypotheses as follows.

**Proposition 2.** *Suppose that  $f_1 = \dots = f_n = 0$  are the triangular equations obtained from  $h_1 = \dots = h_n = 0$  by the above reduction algorithm. Then*

$$V' \subset V \subset \mathbf{V}(f_1, \dots, f_n).$$

**Proof.** As we noted above, all the  $f_j$  are contained in the ideal generated by the  $h_j$ . Thus,  $\langle f_1, \dots, f_n \rangle \subset \langle h_1, \dots, h_n \rangle$  and hence,  $V = \mathbf{V}(h_1, \dots, h_n) \subset \mathbf{V}(f_1, \dots, f_n)$  follows immediately. Since  $V' \subset V$ , we are done.  $\square$

**Example 3.** To illustrate the operation of this triangulation procedure, we will apply it to the hypotheses of the Circle Theorem of Apollonius from §4. Referring back to (5)–(7) of §4, we have

$$\begin{aligned} h_1 &= 2x_1 - u_1, \\ h_2 &= 2x_2 - u_2, \\ h_3 &= 2x_3 - u_1, \\ h_4 &= 2x_4 - u_2, \\ h_5 &= u_2x_5 + u_1x_6 - u_1u_2, \\ h_6 &= u_1x_5 - u_2x_6, \\ h_7 &= x_1^2 - x_2^2 - 2x_1x_7 + 2x_2x_8, \\ h_8 &= x_1^2 - 2x_1x_7 - x_3^2 + 2x_3x_7 - x_4^2 + 2x_4x_8. \end{aligned}$$

Note that this system is very nearly in triangular form in the  $x_j$ . In fact, this is often true, especially in the cases where each step of constructing the geometric configuration involves adding one new point.



At the first step of the triangulation procedure, we see that  $h_7, h_8$  are the only polynomials in our set containing  $x_8$ . Even better,  $h_8$  has degree 1 in  $x_8$ . Hence, we proceed as in step 3 of the triangulation procedure, making  $f_8 = h_8$ , and replacing  $h_7$  by

$$\begin{aligned} f_7 &= \text{Rem}(h_7, h_8, x_8) \\ &= (2x_1x_2 - 2x_2x_3 - 2x_1x_4)x_7 - x_1^2x_2 + x_2x_3^2 + x_1^2x_4 - x_2^2x_4 + x_2x_4^2. \end{aligned}$$

As this example indicates, we often ignore numerical constants when computing remainders. Only  $f_7$  contains  $x_7$ , so nothing further needs to be done there. Both  $h_6$  and  $h_5$  contain  $x_6$ , but we are in the situation of step 3 in the procedure again. We make  $f_6 = h_6$  and replace  $h_5$  by

$$f_5 = \text{Rem}(h_5, h_6, x_6) = (u_1^2 + u_2^2)x_5 - u_1u_2^2.$$

The remaining four polynomials are in triangular form already, so we take  $f_i = h_i$  for  $i = 1, 2, 3, 4$ .

### Step 2. Successive Pseudodivision

The key step in Wu’s method is the successive pseudodivision operation given in equation (3) computing the *final remainder*  $R_0$ . The usefulness of this operation is indicated by the following theorem.

**Theorem 4.** *Consider the set of hypotheses and the conclusion for a geometric theorem. Let  $R_0$  be the final remainder computed by the successive pseudodivision of  $g$  as in (3), using the system of polynomials  $f_1, \dots, f_n$  in triangular form (2). Let  $d_j$  be the leading coefficient of  $f_j$  as a polynomial in  $x_j$  (so  $d_j$  is a polynomial in  $u_1, \dots, u_m$  and  $x_1, \dots, x_{j-1}$ ). Then:*

- (i) *There are nonnegative integers  $s_1, \dots, s_n$  and polynomials  $A_1, \dots, A_n$  in the ring  $\mathbb{R}[u_1, \dots, u_m, x_1, \dots, x_n]$  such that*

$$d_1^{s_1} \cdots d_n^{s_n} g = A_1 f_1 + \cdots + A_n f_n + R_0.$$

- (ii) *If  $R_0$  is the zero polynomial, then  $g$  is zero at every point of  $V' - \mathbf{V}(d_1 d_2 \cdots d_n) \subset \mathbb{R}^{m+n}$ .*

**Proof.** Part (i) follows by applying Proposition 1 repeatedly. Pseudodividing  $g$  by  $f_n$  with respect to  $x_n$ , we have

$$R_{n-1} = d_n^{s_n} g - q_n f_n.$$

Hence, when we pseudodivide again with respect to  $x_{n-1}$ :

$$\begin{aligned} R_{n-2} &= d_{n-1}^{s_{n-1}} (d_n^{s_n} g - q_n f_n) - q_{n-1} f_{n-1} \\ &= d_{n-1}^{s_{n-1}} d_n^{s_n} g - q_{n-1} f_{n-1} - d_{n-1}^{s_{n-1}} q_n f_n. \end{aligned}$$

Continuing in the same way, we will eventually obtain an expression of the form

$$R_0 = d_1^{s_1} \cdots d_n^{s_n} g - (A_1 f_1 + \cdots + A_n f_n),$$

which is what we wanted to show.

(ii) By the result of part (i), if  $R_0 = 0$ , then at every point of the variety  $W = \mathbf{V}(f_1, \dots, f_n)$ , either  $g$  or one of the  $d_j^{s_j}$  is zero. By Proposition 2, the variety  $V'$  is contained in  $W$ , so the same is true on  $V'$ . The assertion follows.  $\square$

Even though they are not always polynomial relations in the  $u_i$  alone, the equations  $d_j = 0$ , where  $d_j$  is the leading coefficient of  $f_j$ , can often be interpreted as loci defining *degenerate special cases* of our geometric configuration.

**Example 3 (continued).** For instance, let us complete the application of Wu's method to the Circle Theorem of Apollonius. Our goal is to show that

$$g = (x_5 - x_7)^2 + (x_6 - x_8)^2 - (x_1 - x_7)^2 - x_8^2 = 0$$

is a consequence of the hypotheses  $h_1 = \cdots = h_8 = 0$  (see (8) of §4). Using  $f_1, \dots, f_8$  computed above, we set  $R_8 = g$  and compute the successive remainders

$$R_{i-1} = \text{Rem}(R_i, f_i, x_i)$$

as  $i$  decreases from 8 to 1. When computing these remainders, we always use the minimal exponent  $s$  in Proposition 1, and in some cases, we ignore constant factors of the remainder. We obtain the following remainders.

$$\begin{aligned} R_7 &= x_4 x_5^2 - 2x_4 x_5 x_7 + x_4 x_6^2 - x_4 x_1^2 + 2x_4 x_1 x_7 + x_6 x_1^2 - 2x_6 x_1 x_7 \\ &\quad - x_6 x_3^2 + 2x_6 x_3 x_7 - x_6 x_4^2, \\ R_6 &= x_4^2 x_1 x_5^2 - x_4^2 x_1^2 x_5 - x_4 x_1 x_6 x_3^2 + x_4^2 x_1 x_6^2 - x_4^3 x_1 x_6 + x_4^2 x_2^2 x_5 \\ &\quad - x_4^2 x_2^2 x_1 - x_2 x_4^3 x_5 + x_2 x_4^3 x_1 - x_2 x_1 x_4 x_5^2 - x_2 x_1 x_4 x_6^2 \\ &\quad + x_2 x_3 x_4 x_5^2 + x_2 x_3 x_4 x_6^2 - x_2 x_3 x_4 x_1^2 + x_4 x_1^2 x_6 x_3 + x_4 x_2^2 x_6 x_1 \\ &\quad - x_4 x_2^2 x_6 x_3 + x_2 x_1^2 x_4 x_5 - x_2 x_3^2 x_4 x_5 + x_2 x_3^2 x_4 x_1, \\ R_5 &= u_2^2 x_4^2 x_1 x_5^2 - u_2^2 x_4^2 x_1^2 x_5 + u_2^2 x_4^2 x_2^2 x_5 - u_2^2 x_4^2 x_2^2 x_1 - u_2^2 x_2 x_4^3 x_5 \\ &\quad + u_2^2 x_2 x_4^3 x_1 - x_4 u_2^2 x_2 x_1 x_5^2 + x_4 u_2^2 x_2 x_3 x_5^2 - x_4 u_2^2 x_2 x_3 x_1^2 \\ &\quad + x_4 u_2^2 x_2 x_1^2 x_5 - x_4 u_2^2 x_2 x_3^2 x_5 + x_4 u_2^2 x_2 x_3^2 x_1 - u_1 x_5 u_2 x_4^3 x_1 \\ &\quad + x_4 u_1 x_5 u_2 x_2^2 x_1 - x_4 u_1 x_5 u_2 x_1 x_3^2 - x_4 u_1 x_5 u_2 x_2^2 x_3 \\ &\quad + x_4 u_1 x_5 u_2 x_1^2 x_3 + u_1^2 x_5^2 x_4^2 x_1 - x_4 u_1^2 x_5^2 x_2 x_1 + x_4 u_1^2 x_5^2 x_2 x_3, \\ R_4 &= -u_2^4 x_4 x_2 x_3 x_1^2 - u_2^4 x_4^2 x_2^2 x_1 + u_2^4 x_4 x_2 x_3^2 x_1 + u_2^4 x_4^3 x_2 x_1 \\ &\quad - u_2^2 x_4 u_1^2 x_2 x_3 x_1^2 - u_2^2 x_4^2 u_1^2 x_2^2 x_1 + u_2^2 x_4 u_1^2 x_2 x_3^2 x_1 \\ &\quad + u_2^2 x_4^3 u_1^2 x_2 x_1 - u_2^4 x_4^3 u_1 x_2 - u_2^3 x_4^3 u_1^2 x_1 + u_2^4 x_4^2 u_1 x_2^2 \\ &\quad - u_2^4 x_4^2 u_1 x_1^2 + u_2^3 x_4 u_1^2 x_2^2 x_1 - u_2^3 x_4 u_1^2 x_1 x_3^2 - u_2^4 x_4 u_1 x_2 x_3^2 \\ &\quad + u_2^4 x_4 u_1 x_2 x_1^2 - u_2^3 x_4 u_1^2 x_2^2 x_3 + u_2^3 x_4 u_1^2 x_1^2 x_3 + u_2^4 x_4^2 u_1^2 x_1 \\ &\quad - u_2^4 x_4 u_1^2 x_2 x_1 + u_2^4 x_4 u_1^2 x_2 x_3, \end{aligned}$$

$$\begin{aligned}
R_3 &= 4u_2^5x_2x_3^2x_1 - 4u_2^5u_1x_2x_3^2 + 4u_2^5u_1x_2x_1^2 - 4u_2^5x_2x_3x_1^2 \\
&\quad - 3u_2^5u_1^2x_2x_1 + 4u_2^5u_1^2x_2x_3 - 4u_2^4u_1^2x_1x_3^2 - 4u_2^4u_1^2x_2^2x_3 \\
&\quad + 2u_2^4u_1^2x_2^2x_1 + 4u_2^4u_1^2x_1^2x_3 - 4u_2^3u_1^2x_2x_3x_1^2 + 4u_2^3u_1^2x_2x_3^2x_1 \\
&\quad - 2u_2^6x_2^2x_1 - 2u_2^6u_1x_1^2 + 2u_2^6u_1x_2^2 + u_2^6u_1^2x_1 + u_2^7x_2x_1 \\
&\quad - u_2^7u_1x_2, \\
R_2 &= 2u_2^5u_1x_2x_1^2 - 2u_2^5u_1^2x_2x_1 + 2u_2^4u_1^2x_2^2x_1 - 2u_2^6x_2^2x_1 \\
&\quad - 2u_2^6u_1x_1^2 + 2u_2^6u_1x_2^2 + u_2^6u_1^2x_1 + u_2^7x_2x_1 - u_2^7u_1x_2 \\
&\quad + u_2^5u_1^3x_2 - 2u_2^4u_1^3x_2^2 + 2u_2^4u_1^3x_1^2 - 2u_2^3u_1^3x_2x_1^2 + u_2^3u_1^4x_2x_1 \\
&\quad - u_2^4u_1^4x_1, \\
R_1 &= -2u_2^6u_1x_1^2 - u_2^4u_1^4x_1 + u_2^6u_1^2x_1 + 2u_2^4u_1^3x_1^2, \\
R_0 &= 0.
\end{aligned}$$

By Theorem 4, Wu's method confirms that the Circle Theorem is valid when none of the leading coefficients of the  $f_j$  is zero. The nontrivial conditions here are

$$\begin{aligned}
d_5 &= u_1^2 + u_2^2 \neq 0, \\
d_6 &= u_2 \neq 0, \\
d_7 &= 2x_1x_2 - 2x_2x_3 - 2x_1x_4 \neq 0, \\
d_8 &= 2x_4 \neq 0.
\end{aligned}$$

The second condition in this list is  $u_2 \neq 0$ , which says that the vertices  $A$  and  $C$  of the right triangle  $\triangle ABC$  are distinct [recall we chose coordinates so that  $A = (0, 0)$  and  $C = (0, u_2)$  in Example 3 of §4]. This also implies the first condition since  $u_1$  and  $u_2$  are real. The condition  $2x_4 \neq 0$  is equivalent to  $u_2 \neq 0$  by the hypothesis  $h_4 = 0$ . Finally,  $d_7 \neq 0$  says that the vertices of the triangle are distinct (see Exercise 5). From this analysis, we see that the Circle Theorem actually follows generically from its hypotheses as in §4.

The elementary version of Wu's method only gives  $g = 0$  under the side conditions  $d_j \neq 0$ . In particular, note that in a case where  $V'$  is reducible, it is entirely conceivable that one of the  $d_j$  could vanish on an entire component of  $V'$ . If this happened, there would be no conclusion concerning the validity of the theorem for geometric configurations corresponding to points in that component.

Indeed, a much stronger version of Theorem 4 is known when the subvariety  $V'$  for a given set of hypotheses is *irreducible*. With the extra algebraic tools we have omitted (Ritt's decomposition algorithm), it can be proved that there are special triangular form sets of  $f_j$  (called characteristic sets) with the property that  $R_0 = 0$  is a necessary and sufficient condition for  $g$  to lie in  $\mathbf{I}(V')$ . In particular, it is never the case that one of the leading coefficients of the  $f_j$  is identically zero on  $V'$  so that  $R_0 = 0$  implies that  $g$  must vanish on all of  $V'$ . We refer the interested reader to CHOU (1988) for the details. Other treatments of characteristic sets and the Wu–Ritt algorithm can be found in MISHRA (1993) and WANG (1994b). There is also a Maple package

called “charsets” which implements the method of characteristic sets [see WANG (1994a)].

Finally, we will briefly compare Wu's method with the method based on Groebner bases introduced in §4. These two methods apply to exactly the same class of geometric theorems and they usually yield equivalent results. Both make essential use of a division algorithm to determine whether a polynomial is in a given ideal or not. However, as we can guess from the triangulation procedure described above, the basic version of Wu's method at least is likely to be much quicker on a given problem. The reason is that simply triangulating a set of polynomials usually requires much less effort than computing a Groebner basis for the ideal they generate, or for the ideal  $\tilde{H} = \langle h_1, \dots, h_n, 1 - yg \rangle$ . This pattern is especially pronounced when the original polynomials themselves are nearly in triangular form, which is often the case for the hypotheses of a geometric theorem. In a sense, this superiority of Wu's method is only natural since Groebner bases contain much more information than triangular form sets. Note that we have not claimed anywhere that the triangular form set of polynomials even generates the same ideal as the hypotheses in either  $\mathbb{R}[u_1, \dots, u_m, x_1, \dots, x_n]$  or  $\mathbb{R}(u_1, \dots, u_m)[x_1, \dots, x_n]$ . In fact, this is not true in general (Exercise 4). Wu's method is an example of a technique tailored to solve a particular problem. Such techniques can often outperform general techniques (such as computing Groebner bases) that do many other things besides.

For the reader interested in pursuing this topic further, we recommend CHOU (1988), the second half of which is an annotated collection of 512 geometric theorems proved by Chou's program implementing Wu's method. Wu (1983) is a reprint of the original paper that introduced these ideas.

## EXERCISES FOR §5

1. This problem completes the proof of Proposition 1 begun in the text.
  - a. Complete the proof of (i) of the proposition.
  - b. Show that  $q, r$  in the equation  $d_m^s f = qg + r$  in the proposition are definitely *not* unique if no condition is placed on the exponent  $s$ .
2. Establish the claim stated after Proposition 1 that pseudodivision is equivalent to ordinary polynomial division in the ring  $K[y]$ , where  $K = k(x_1, \dots, x_n)$ .
3. Show that there is a unique minimal  $s \leq p - m + 1$  in Proposition 1 for which the equation  $d_m^s f = qg + r$  exists, and that  $q$  and  $r$  are unique when  $s$  is minimal. Hint: Use the uniqueness of the quotient and remainder for division in  $k(x_1, \dots, x_n)[y]$ .
4. Show by example that applying the triangulation procedure described in this section to two polynomials  $h_1, h_2 \in k[x_1, x_2]$  can yield polynomials  $f_1, f_2$  that generate an ideal strictly smaller than  $\langle h_1, h_2 \rangle$ . The same can be true for larger sets of polynomials as well.
5. Show that the nondegeneracy condition  $d_7 \neq 0$  for the Circle Theorem is automatically satisfied if  $u_1$  and  $u_2$  are nonzero.
6. Use Wu's method to verify each of the following theorems. In each case, state the conditions  $d_j \neq 0$  under which Theorem 4 implies that the conclusion follows from the hypotheses. If you also did the corresponding Exercises in §4, try to compare the time and/or effort involved with each method.
  - a. The theorem on the diagonals of a parallelogram (Example 1 of §4).
  - b. The theorem on the orthocenter of a triangle (Exercise 5 of §4).

- c. The theorem on the centroid of a triangle (Exercise 6 of §4).
  - d. The theorem on the Euler line of a triangle (Exercise 7 of §4).
  - e. Pappus's Theorem (Exercise 8 of §4).
7. Consider the theorem from Exercise 17 of §4 (for which  $V'$  is reducible according to a direct translation of the hypotheses).
- a. Apply Wu's method to this problem. (Your final remainder should be nonzero here.)
  - b. Does Wu's method succeed for the reformulation from part e of Exercise 17 from §4?

# 7

## Invariant Theory of Finite Groups

Invariant theory has had a profound effect on the development of algebraic geometry. For example, the Hilbert Basis Theorem and Hilbert Nullstellensatz, which play a central role in the earlier chapters in this book, were proved by Hilbert in the course of his investigations of invariant theory.

In this chapter, we will study the invariants of finite groups. The basic goal is to describe *all* polynomials which are unchanged when we change variables according to a given finite group of matrices. Our treatment will be elementary and by no means complete. In particular, we do not presume a prior knowledge of group theory.

### §1 Symmetric Polynomials

Symmetric polynomials arise naturally when studying the roots of a polynomial. For example, consider the cubic  $f = x^3 + bx^2 + cx + d$  and let its roots be  $\alpha_1, \alpha_2, \alpha_3$ . Then

$$x^3 + bx^2 + cx + d = (x - \alpha_1)(x - \alpha_2)(x - \alpha_3).$$

If we expand the right-hand side, we obtain

$$x^3 + bx^2 + cx + d = x^3 - (\alpha_1 + \alpha_2 + \alpha_3)x^2 + (\alpha_1\alpha_2 + \alpha_1\alpha_3 + \alpha_2\alpha_3)x - \alpha_1\alpha_2\alpha_3,$$

and thus,

$$\begin{aligned} b &= -(\alpha_1 + \alpha_2 + \alpha_3), \\ c &= \alpha_1\alpha_2 + \alpha_1\alpha_3 + \alpha_2\alpha_3, \\ d &= -\alpha_1\alpha_2\alpha_3. \end{aligned} \tag{1}$$

This shows that the coefficients of  $f$  are polynomials in its roots. Further, since changing the order of the roots does not affect  $f$ , it follows that the polynomials expressing  $b, c, d$  in terms of  $\alpha_1, \alpha_2, \alpha_3$  are unchanged if we permute  $\alpha_1, \alpha_2, \alpha_3$ . Such polynomials are said to be *symmetric*. The general concept is defined as follows.

**Definition 1.** A polynomial  $f \in k[x_1, \dots, x_n]$  is **symmetric** if

$$f(x_{i_1}, \dots, x_{i_n}) = f(x_1, \dots, x_n)$$

for every possible permutation  $x_{i_1}, \dots, x_{i_n}$  of the variables  $x_1, \dots, x_n$ .

For example, if the variables are  $x$ ,  $y$ , and  $z$ , then  $x^2 + y^2 + z^2$  and  $xyz$  are obviously symmetric. The following symmetric polynomials will play an important role in our discussion.

**Definition 2.** Given variables  $x_1, \dots, x_n$ , we define the **elementary symmetric functions**  $\sigma_1, \dots, \sigma_n \in k[x_1, \dots, x_n]$  by the formulas

$$\begin{aligned} \sigma_1 &= x_1 + \cdots + x_n, \\ &\vdots \\ \sigma_r &= \sum_{i_1 < i_2 < \cdots < i_r} x_{i_1} x_{i_2} \cdots x_{i_r}, \\ &\vdots \\ \sigma_n &= x_1 x_2 \cdots x_n. \end{aligned}$$

Thus,  $\sigma_r$  is the sum of all monomials that are products of  $r$  distinct variables. In particular, every term of  $\sigma_r$  has total degree  $r$ . To see that these polynomials are indeed symmetric, we will generalize observation (1). Namely, introduce a new variable  $X$  and consider the polynomial

$$(2) \quad f(X) = (X - x_1)(X - x_2) \cdots (X - x_n)$$

with roots  $x_1, \dots, x_n$ . If we expand the right-hand side, it is straightforward to show that

$$f(X) = X^n - \sigma_1 X^{n-1} + \sigma_2 X^{n-2} + \cdots + (-1)^{n-1} \sigma_{n-1} X + (-1)^n \sigma_n$$

(we leave the details of the proof as an exercise). Now suppose that we rearrange  $x_1, \dots, x_n$ . This changes the order of the factors on the right-hand side of (2), but  $f$  itself will be unchanged. Thus, the coefficients  $(-1)^r \sigma_r$  of  $f$  are symmetric functions.

One corollary is that for any polynomial with leading coefficient 1, the other coefficients are the elementary symmetric functions of its roots (up to a factor of  $\pm 1$ ). The exercises will explore some interesting consequences of this fact.

From the elementary symmetric functions, we can construct other symmetric functions by taking polynomials in  $\sigma_1, \dots, \sigma_n$ . Thus, for example,

$$\sigma_2^2 - \sigma_1 \sigma_3 = x^2 y^2 + x^2 y z + x^2 z^2 + x y^2 z + x y z^2 + y^2 z^2$$

is a symmetric polynomial. What is more surprising is that *all* symmetric polynomials can be represented in this way.

**Theorem 3 (The Fundamental Theorem of Symmetric Polynomials).** *Every symmetric polynomial in  $k[x_1, \dots, x_n]$  can be written uniquely as a polynomial in the elementary symmetric functions  $\sigma_1, \dots, \sigma_n$ .*

**Proof.** We will use lex order with  $x_1 > x_2 > \dots > x_n$ . Given a nonzero symmetric polynomial  $f \in k[x_1, \dots, x_n]$ , let  $\text{LT}(f) = ax^\alpha$ . If  $\alpha = (\alpha_1, \dots, \alpha_n)$ , we first claim that  $\alpha_1 \geq \alpha_2 \geq \dots \geq \alpha_n$ . To prove this, suppose that  $\alpha_i < \alpha_{i+1}$  for some  $i$ . Let  $\beta$  be the exponent vector obtained from  $\alpha$  by switching  $\alpha_i$  and  $\alpha_{i+1}$ . We will write this as  $\beta = (\dots, \alpha_{i+1}, \alpha_i, \dots)$ . Since  $ax^\alpha$  is a term of  $f$ , it follows that  $ax^\beta$  is a term of  $f(\dots, x_{i+1}, x_i, \dots)$ . But  $f$  is symmetric, so that  $f(\dots, x_{i+1}, x_i, \dots) = f$ , and thus,  $ax^\beta$  is a term of  $f$ . This is impossible since  $\beta > \alpha$  under lex order, and our claim is proved.

Now let

$$h = \sigma_1^{\alpha_1 - \alpha_2} \sigma_2^{\alpha_2 - \alpha_3} \dots \sigma_{n-1}^{\alpha_{n-1} - \alpha_n} \sigma_n^{\alpha_n}.$$

To compute the leading term of  $h$ , first note that  $\text{LT}(\sigma_r) = x_1 x_2 \dots x_r$  for  $1 \leq r \leq n$ . Hence,

$$\begin{aligned} \text{LT}(h) &= \text{LT}(\sigma_1^{\alpha_1 - \alpha_2} \sigma_2^{\alpha_2 - \alpha_3} \dots \sigma_n^{\alpha_n}) \\ &= \text{LT}(\sigma_1)^{\alpha_1 - \alpha_2} \text{LT}(\sigma_2)^{\alpha_2 - \alpha_3} \dots \text{LT}(\sigma_n)^{\alpha_n} \\ (3) \quad &= x_1^{\alpha_1 - \alpha_2} (x_1 x_2)^{\alpha_2 - \alpha_3} \dots (x_1 \dots x_n)^{\alpha_n} \\ &= x_1^{\alpha_1} x_2^{\alpha_2} \dots x_n^{\alpha_n} = x^\alpha. \end{aligned}$$

It follows that  $f$  and  $ah$  have the same leading term, and thus,

$$\text{multideg}(f - ah) < \text{multideg}(f)$$

whenever  $f - ah \neq 0$ .

Now set  $f_1 = f - ah$  and note that  $f_1$  is symmetric since  $f$  and  $ah$  are. Hence, if  $f_1 \neq 0$ , we can repeat the above process to form  $f_2 = f_1 - a_1 h_1$ , where  $a_1$  is a constant and  $h_1$  is a product of  $\sigma_1, \dots, \sigma_n$  to various powers. Further, we know that  $\text{LT}(f_2) < \text{LT}(f_1)$  when  $f_2 \neq 0$ . Continuing in this way, we get a sequence of polynomials  $f, f_1, f_2, \dots$  with

$$\text{multideg}(f) > \text{multideg}(f_1) > \text{multideg}(f_2) > \dots.$$

Since lex order is a well-ordering, the sequence must be finite. But the only way the process terminates is when  $f_{t+1} = 0$  for some  $t$ . Then it follows easily that

$$f = ah + a_1 h_1 + \dots + a_t h_t,$$

which shows that  $f$  is a polynomial in the elementary symmetric functions. Finally, we need to prove uniqueness. Suppose that we have a symmetric polynomial  $f$  which can be written

$$f = g_1(\sigma_1, \dots, \sigma_n) = g_2(\sigma_1, \dots, \sigma_n).$$

Here,  $g_1$  and  $g_2$  are polynomials in  $n$  variables, say  $y_1, \dots, y_n$ . We need to prove that  $g_1 = g_2$  in  $k[y_1, \dots, y_n]$ .



If we set  $g = g_1 - g_2$ , then  $g(\sigma_1, \dots, \sigma_n) = 0$  in  $k[x_1, \dots, x_n]$ . Uniqueness will be proved if we can show that  $g = 0$  in  $k[y_1, \dots, y_n]$ . So suppose that  $g \neq 0$ . If we write  $g = \sum_{\beta} a_{\beta} y^{\beta}$ , then  $g(\sigma_1, \dots, \sigma_n)$  is a sum of the polynomials  $g_{\beta} = a_{\beta} \sigma_1^{\beta_1} \sigma_2^{\beta_2} \cdots \sigma_n^{\beta_n}$ , where  $\beta = (\beta_1, \dots, \beta_n)$ . Furthermore, the argument used in (3) above shows that

$$\text{LT}(g_{\beta}) = a_{\beta} x_1^{\beta_1 + \cdots + \beta_n} x_2^{\beta_2 + \cdots + \beta_n} \cdots x_n^{\beta_n}.$$

It is an easy exercise to show that the map

$$(\beta_1, \dots, \beta_n) \mapsto (\beta_1 + \cdots + \beta_n, \beta_2 + \cdots + \beta_n, \dots, \beta_n)$$

is injective. Thus, the  $g_{\beta}$ 's have distinct leading terms. In particular, if we pick  $\beta$  such that  $\text{LT}(g_{\beta}) > \text{LT}(g_{\gamma})$  for all  $\gamma \neq \beta$ , then  $\text{LT}(g_{\beta})$  will be greater than *all* terms of the  $g_{\gamma}$ 's. It follows that there is nothing to cancel  $\text{LT}(g_{\beta})$  and, thus,  $g(\sigma_1, \dots, \sigma_n)$  cannot be zero in  $k[x_1, \dots, x_n]$ . This contradiction completes the proof of the theorem.  $\square$

The proof just given is due to Gauss, who needed the properties of symmetric polynomials for his second proof (dated 1816) of the fundamental theorem of algebra. Here is how Gauss states lex order: "Then among the two terms

$$Ma^{\alpha} b^{\beta} c^{\gamma} \cdots \quad \text{and} \quad Ma^{\alpha'} b^{\beta'} c^{\gamma'} \cdots$$

superior order is attributed to the first rather than the second, if

$$\text{either } \alpha > \alpha', \text{ or } \alpha = \alpha' \text{ and } \beta > \beta', \text{ or } \alpha = \alpha', \beta = \beta' \text{ and } \gamma > \gamma', \text{ or etc.}''$$

[see p. 36 of GAUSS (1876)]. This is the earliest known explicit statement of lex order.

Note that the proof of Theorem 3 gives an algorithm for writing a symmetric polynomial in terms of  $\sigma_1, \dots, \sigma_n$ . For an example of how this works, consider

$$f = x^3 y + x^3 z + x y^3 + x z^3 + y^3 z + y z^3 \in k[x, y, z].$$

The leading term of  $f$  is  $x^3 y = \text{LT}(\sigma_1^2 \sigma_2)$ , which gives

$$f_1 = f - \sigma_1^2 \sigma_2 = -2x^2 y^2 - 5x^2 y z - 2x^2 z^2 - 5x y^2 z - 5x y z^2 - 2y^2 z^2.$$

The leading term is now  $-2x^2 y^2 = -2\text{LT}(\sigma_2^2)$ , and thus,

$$f_2 = f - \sigma_1^2 \sigma_2 + 2\sigma_2^2 = -x^2 y z - x y^2 z - x y z^2.$$

Then one easily sees that

$$f_3 = f - \sigma_1^2 \sigma_2 + 2\sigma_2^2 + \sigma_1 \sigma_3 = 0$$

and hence,

$$f = \sigma_1^2 \sigma_2 - 2\sigma_2^2 - \sigma_1 \sigma_3$$

is the unique expression of  $f$  in terms of the elementary symmetric polynomials.

Surprisingly, we do not need to write a general algorithm for expressing a symmetric polynomial in  $\sigma_1, \dots, \sigma_n$ , for we can do this process using the division algorithm from Chapter 2. We can even use the division algorithm to check for symmetry. The precise method is as follows.

**Proposition 4.** *In the ring  $k[x_1, \dots, x_n, y_1, \dots, y_n]$ , fix a monomial order where any monomial involving one of  $x_1, \dots, x_n$  is greater than all monomials in  $k[y_1, \dots, y_n]$ . Let  $G$  be a Groebner basis of the ideal  $\langle \sigma_1 - y_1, \dots, \sigma_n - y_n \rangle \subset k[x_1, \dots, x_n, y_1, \dots, y_n]$ . Given  $f \in k[x_1, \dots, x_n]$ , let  $g = \overline{f}^G$  be the remainder of  $f$  on division by  $G$ . Then:*

- (i)  *$f$  is symmetric if and only if  $g \in k[y_1, \dots, y_n]$ .*
- (ii) *If  $f$  is symmetric, then  $f = g(\sigma_1, \dots, \sigma_n)$  is the unique expression of  $f$  as a polynomial in the elementary symmetric functions  $\sigma_1, \dots, \sigma_n$ .*

**Proof.** As above, we have  $f \in k[x_1, \dots, x_n]$ , and  $g \in k[x_1, \dots, x_n, y_1, \dots, y_n]$  is its remainder on division by  $G = \{g_1, \dots, g_t\}$ . This means that

$$f = A_1g_1 + \dots + A_tg_t + g,$$

where  $A_1, \dots, A_t \in k[x_1, \dots, x_n, y_1, \dots, y_n]$ . We can assume that  $g_i \neq 0$  for all  $i$ .

To prove (i), first suppose that  $g \in k[y_1, \dots, y_n]$ . Then for each  $i$ , substitute  $\sigma_i$  for  $y_i$  in the above formula for  $f$ . This will not affect  $f$  since it involves only  $x_1, \dots, x_n$ . The crucial observation is that under this substitution, every polynomial in  $\langle \sigma_1 - y_1, \dots, \sigma_n - y_n \rangle$  goes to zero. Since  $g_1, \dots, g_t$  lie in this ideal, it follows that

$$f = g(\sigma_1, \dots, \sigma_n).$$

Hence,  $f$  is symmetric.

Conversely, suppose that  $f \in k[x_1, \dots, x_n]$  is symmetric. Then  $f = g(\sigma_1, \dots, \sigma_n)$  for some  $g \in k[y_1, \dots, y_n]$ . We want to show that  $g$  is the remainder of  $f$  on division by  $G$ . To prove this, first note that in  $k[x_1, \dots, x_n, y_1, \dots, y_n]$ , a monomial in  $\sigma_1, \dots, \sigma_n$  can be written as follows:

$$\begin{aligned} \sigma_1^{\alpha_1} \cdots \sigma_n^{\alpha_n} &= (y_1 + (\sigma_1 - y_1))^{\alpha_1} \cdots (y_n + (\sigma_n - y_n))^{\alpha_n} \\ &= y_1^{\alpha_1} \cdots y_n^{\alpha_n} + B_1 \cdot (\sigma_1 - y_1) + \cdots + B_n \cdot (\sigma_n - y_n) \end{aligned}$$

for some  $B_1, \dots, B_n \in k[x_1, \dots, x_n, y_1, \dots, y_n]$ . Multiplying by an appropriate constant and adding over the exponents appearing in  $g$ , it follows that

$$g(\sigma_1, \dots, \sigma_n) = g(y_1, \dots, y_n) + C_1 \cdot (\sigma_1 - y_1) + \cdots + C_n \cdot (\sigma_n - y_n),$$

where  $C_1, \dots, C_n \in k[x_1, \dots, x_n, y_1, \dots, y_n]$ . Since  $f = g(\sigma_1, \dots, \sigma_n)$ , we can write this as

$$(4) \quad f = C_1 \cdot (\sigma_1 - y_1) + \cdots + C_n \cdot (\sigma_n - y_n) + g(y_1, \dots, y_n).$$

We want to show that  $g$  is the remainder of  $f$  on division by  $G$ .

The first step is to show that no term of  $g$  is divisible by an element of  $\text{LT}(G)$ . If this were false, then there would be  $g_i \in G$ , where  $\text{LT}(g_i)$  divides some term of  $g$ . Hence,  $\text{LT}(g_i)$  would involve only  $y_1, \dots, y_n$  since  $g \in k[y_1, \dots, y_n]$ . By our hypothesis on the ordering, it would follow that  $g_i \in k[y_1, \dots, y_n]$ . Now replace every  $y_i$  with the corresponding  $\sigma_i$ . Since  $g_i \in \langle \sigma_1 - y_1, \dots, \sigma_n - y_n \rangle$ , we have already observed that  $g_i$  goes to zero under the substitution  $y_i \mapsto \sigma_i$ . Then  $g_i \in k[y_1, \dots, y_n]$  would mean  $g_i(\sigma_1, \dots, \sigma_n) = 0$ . By the uniqueness part of Theorem 3, this would imply  $g_i = 0$ , which is impossible since  $g_i \neq 0$ . This proves our claim. It follows that in (4), no term

of  $g$  is divisible by an element of  $\text{LT}(G)$ , and since  $G$  is a Groebner basis, Proposition 1 of Chapter 2, §6 tells us that  $g$  is the remainder of  $f$  on division by  $G$ . This proves that the remainder lies in  $k[y_1, \dots, y_n]$  when  $f$  is symmetric.

Part (ii) of the proposition follows immediately from the above arguments and we are done.  $\square$

A seeming drawback to the above proposition is the necessity to compute a Groebner basis for  $\langle \sigma_1 - y_1, \dots, \sigma_n - y_n \rangle$ . However, when we use lex order, it is quite simple to write down a Groebner basis for this ideal. We first need some notation. Given variables  $u_1, \dots, u_s$ , let

$$h_i(u_1, \dots, u_s) = \sum_{|\alpha|=i} u^\alpha$$

be the sum of *all* monomials of total degree  $i$  in  $u_1, \dots, u_s$ . Then we get the following Groebner basis.

**Proposition 5.** *Fix lex order on  $k[x_1, \dots, x_n, y_1, \dots, y_n]$  with  $x_1 > \dots > x_n > y_1 > \dots > y_n$ . Then the polynomials*

$$g_k = h_k(x_k, \dots, x_n) + \sum_{i=1}^k (-1)^i h_{k-i}(x_k, \dots, x_n) y_i, \quad k = 1, \dots, n,$$

*form a Groebner basis for the ideal  $\langle \sigma_1 - y_1, \dots, \sigma_n - y_n \rangle$ .*

**Proof.** We will sketch the proof, leaving most of the details for the exercises. The first step is to note the polynomial identity

$$(5) \quad 0 = h_k(x_k, \dots, x_n) + \sum_{i=1}^k (-1)^i h_{k-i}(x_k, \dots, x_n) \sigma_i.$$

The proof will be covered in Exercises 10 and 11.

The next step is to show that  $g_1, \dots, g_n$  form a basis of  $\langle \sigma_1 - y_1, \dots, \sigma_n - y_n \rangle$ . If we subtract the identity (5) from the definition of  $g_k$ , we obtain

$$(6) \quad g_k = \sum_{i=1}^k (-1)^i h_{k-i}(x_k, \dots, x_n) (y_i - \sigma_i),$$

which proves that  $\langle g_1, \dots, g_n \rangle \subset \langle \sigma_1 - y_1, \dots, \sigma_n - y_n \rangle$ . To prove the opposite inclusion, note that since  $h_0 = 1$ , we can write (6) as

$$(7) \quad g_k = (-1)^k (y_k - \sigma_k) + \sum_{i=1}^{k-1} (-1)^i h_{k-i}(x_k, \dots, x_n) (y_i - \sigma_i).$$

Then induction on  $k$  shows that  $\langle \sigma_1 - y_1, \dots, \sigma_n - y_n \rangle \subset \langle g_1, \dots, g_n \rangle$  (see Exercise 12).

Finally, we need to show that we have a Groebner basis. In Exercise 12, we will ask you to prove that

$$\text{LT}(g_k) = x_k^k.$$

This is where we use lex order with  $x_1 > \cdots > x_n > y_1 > \cdots > y_n$ . Thus the leading terms of  $g_1, \dots, g_k$  are relatively prime, and using the theory developed in §9 of Chapter 2, it is easy to show that we have a Groebner basis (see Exercise 12 for the details). This completes the proof.  $\square$

In dealing with symmetric polynomials, it is often convenient to work with ones that are *homogeneous*. Here is the definition.

**Definition 6.** A polynomial  $f \in k[x_1, \dots, x_n]$  is **homogeneous of total degree  $k$**  provided that every term appearing in  $f$  has total degree  $k$ .

As an example, note that the  $i$ -th elementary symmetric function  $\sigma_i$  is homogeneous of total degree  $i$ . An important fact is that every polynomial can be written uniquely as a sum of homogeneous polynomials. Namely, given  $f \in k[x_1, \dots, x_n]$ , let  $f_k$  be the sum of all terms of  $f$  of total degree  $k$ . Then each  $f_k$  is homogeneous and  $f = \sum_k f_k$ . We call  $f_k$  the  $k$ -th *homogeneous component* of  $f$ .

We can understand symmetric polynomials in terms of their homogeneous components as follows.

**Proposition 7.** A polynomial  $f \in k[x_1, \dots, x_n]$  is symmetric if and only if all of its homogeneous components are symmetric.

**Proof.** Given a symmetric polynomial  $f$ , let  $x_{i_1}, \dots, x_{i_n}$  be a permutation of  $x_1, \dots, x_n$ . This permutation takes a term of  $f$  of total degree  $k$  to one of the same total degree. Since  $f(x_{i_1}, \dots, x_{i_n}) = f(x_1, \dots, x_n)$ , it follows that the  $k$ -th homogeneous component must also be symmetric. The converse is trivial and the proposition is proved.  $\square$

Proposition 7 tells us that when working with a symmetric polynomial, we can assume that it is homogeneous. In the exercises, we will explore what this implies about how the polynomial is expressed in terms of  $\sigma_1, \dots, \sigma_n$ .

The final topic we will explore is a different way of writing symmetric polynomials. Specifically, we will consider the *power sums*

$$s_k = x_1^k + x_2^k + \cdots + x_n^k.$$

Note that  $s_k$  is symmetric. Then we can write an arbitrary symmetric polynomial in terms of  $s_1, \dots, s_n$  as follows.

**Theorem 8.** If  $k$  is a field containing the rational numbers  $\mathbb{Q}$ , then every symmetric polynomial in  $k[x_1, \dots, x_n]$  can be written as a polynomial in the power sums  $s_1, \dots, s_n$ .

**Proof.** Since every symmetric polynomial is a polynomial in the elementary symmetric functions (by Theorem 3), it suffices to prove that  $\sigma_1, \dots, \sigma_n$  are polynomials in  $s_1, \dots, s_n$ . For this purpose, we will use the *Newton identities*, which state that

$$\begin{aligned} s_k - \sigma_1 s_{k-1} + \cdots + (-1)^{k-1} \sigma_{k-1} s_1 + (-1)^k k \sigma_k &= 0, \quad 1 \leq k \leq n, \\ s_k - \sigma_1 s_{k-1} + \cdots + (-1)^{n-1} \sigma_{n-1} s_{k-n+1} + (-1)^n \sigma_n s_{k-n} &= 0, \quad k > n. \end{aligned}$$

The proof of these identities will be given in the exercises.

We now prove by induction on  $k$  that  $\sigma_k$  is a polynomial in  $s_1, \dots, s_n$ . This is true for  $k = 1$  since  $\sigma_1 = s_1$ . If the claim is true for  $1, 2, \dots, k-1$ , then the Newton identities imply that

$$\sigma_k = (-1)^{k-1} \frac{1}{k} (s_k - \sigma_1 s_{k-1} + \cdots + (-1)^{k-1} \sigma_{k-1} s_1).$$

We can divide by the integer  $k$  because  $\mathbb{Q}$  is contained in the coefficient field (see Exercise 16 for an example of what can go wrong when  $\mathbb{Q} \not\subset k$ ). Then our inductive assumption and the above equation show that  $\sigma_k$  is a polynomial in  $s_1, \dots, s_n$ .  $\square$

As a consequence of Theorems 3 and 8, every elementary symmetric function can be written in terms of power sums, and vice versa. For example,

$$\begin{aligned} s_2 &= \sigma_1^2 - 2\sigma_2 \iff \sigma_2 = \frac{1}{2}(s_1^2 - s_2), \\ s_3 &= \sigma_1^3 - 3\sigma_1\sigma_2 + 3\sigma_3 \iff \sigma_3 = \frac{1}{6}(s_1^3 - 3s_1s_2 + 2s_3). \end{aligned}$$

Power sums will be unexpectedly useful in §3 when we give an algorithm for finding the invariant polynomials for a finite group.

### EXERCISES FOR §1

1. Prove that  $f \in k[x, y, z]$  is symmetric if and only if  $f(x, y, z) = f(y, x, z) = f(y, z, x)$ .
2. (Requires abstract algebra) Prove that  $f \in k[x_1, \dots, x_n]$  is symmetric if and only if  $f(x_1, x_2, x_3, \dots, x_n) = f(x_2, x_1, x_3, \dots, x_n) = f(x_2, x_3, \dots, x_n, x_1)$ . Hint: Show that the cyclic permutations  $(1, 2)$  and  $(1, 2, \dots, n)$  generate the symmetric group  $S_n$ . See Exercise 11 in §2.10 of HERSTEIN (1975).
3. Let  $\sigma_i^n$  be the  $i$ -th elementary symmetric function in variables  $x_1, \dots, x_n$ . The superscript  $n$  denotes the number of variables and is not an exponent. We also set  $\sigma_0^n = 1$  and  $\sigma_i^n = 0$  if  $i < 0$  or  $i > n$ . Prove that  $\sigma_i^n = \sigma_i^{n-1} + x_n \sigma_{i-1}^{n-1}$  for all  $n > 1$  and all  $i$ . This identity is useful in induction arguments involving elementary symmetric functions.
4. As in (2), let  $f(X) = (X - x_1)(X - x_2) \cdots (X - x_n)$ . Prove that  $f = X^n - \sigma_1 X^{n-1} + \sigma_2 X^{n-2} + \cdots + (-1)^{n-1} \sigma_{n-1} X + (-1)^n \sigma_n$ . Hint: You can give an induction proof using the identities of Exercise 3.
5. Consider the polynomial

$$f = (x^2 + y^2)(x^2 + z^2)(y^2 + z^2) \in k[x, y, z].$$

- a. Use the method given in the proof of Theorem 3 to write  $f$  as a polynomial in the elementary symmetric functions  $\sigma_1, \sigma_2, \sigma_3$ .
- b. Use the method described in Proposition 4 to write  $f$  in terms of  $\sigma_1, \sigma_2, \sigma_3$ .

You can use a computer algebra system for both parts of the exercise. Note that by stripping off the coefficients of powers of  $X$  in the polynomial  $(X - x)(X - y)(X - z)$ , you can get the computer to generate the elementary symmetric functions.

6. If the variables are  $x_1, \dots, x_n$ , show that  $\sum_{i \neq j} x_i^2 x_j = \sigma_1 \sigma_2 - 3\sigma_3$ . Hint: If you get stuck, see Exercise 13. Note that a computer algebra system cannot help here!
7. Let  $f = x^n + a_1 x^{n-1} + \dots + a_n \in k[x]$  have roots  $\alpha_1, \dots, \alpha_n$ , which lie in some bigger field  $K$  containing  $k$ .
  - a. Prove that any symmetric polynomial  $g(\alpha_1, \dots, \alpha_n)$  in the roots of  $f$  can be expressed as a polynomial in the coefficients  $a_1, \dots, a_n$  of  $f$ .
  - b. In particular, if the symmetric polynomial  $g$  has coefficients in  $k$ , conclude that  $g(\alpha_1, \dots, \alpha_n) \in k$ .
8. As in Exercise 7, let  $f = x^n + a_1 x^{n-1} + \dots + a_n \in k[x]$  have roots  $\alpha_1, \dots, \alpha_n$ , which lie in some bigger field  $K$  containing  $k$ . The *discriminant* of  $f$  is defined to be

$$D(f) = \prod_{i \neq j} (\alpha_i - \alpha_j)$$

- a. Use Exercise 7 to show that  $D(f)$  is a polynomial in  $a_1, \dots, a_n$ .
- b. When  $n = 2$ , express  $D(f)$  in terms of  $a_1$  and  $a_2$ . Does your result look familiar?
- c. When  $n = 3$ , express  $D(f)$  in terms of  $a_1, a_2, a_3$ .
- d. Explain why a cubic polynomial  $x^3 + a_1 x^2 + a_2 x + a_3$  has a multiple root if and only if  $-4a_1^3 a_3 + a_1^2 a_2^2 + 18a_1 a_2 a_3 - 4a_2^3 - 27a_3^2 = 0$ .
9. Given a cubic polynomial  $f = x^3 + a_1 x^2 + a_2 x + a_3$ , what condition must the coefficients of  $f$  satisfy in order for one of its roots to be the average of the other two? Hint: If  $\alpha_1$  is the average of the other two, then  $2\alpha_1 - \alpha_2 - \alpha_3 = 0$ . But it could happen that  $\alpha_2$  or  $\alpha_3$  is the average of the other two. Hence, you get a condition stating that the product of three expressions similar to  $2\alpha_1 - \alpha_2 - \alpha_3$  is equal to zero. Now use Exercise 7.
10. As in Proposition 5, let  $h_i(x_1, \dots, x_n)$  be the sum of all monomials of total degree  $i$  in  $x_1, \dots, x_n$ . Also, let  $\sigma_0 = 1$  and  $\sigma_i = 0$  if  $i > n$ . The goal of this exercise is to show that

$$0 = \sum_{i=0}^k (-1)^i h_{k-i}(x_1, \dots, x_n) \sigma_i(x_1, \dots, x_n).$$

In Exercise 11, we will use this to prove the closely related identity (5) that appears in the text. To prove the above identity, we will compute the coefficients of the monomials  $x^\alpha$  that appear in  $h_{k-i} \sigma_i$ . Since every term in  $h_{k-i} \sigma_i$  has total degree  $k$ , we can assume that  $x^\alpha$  has total degree  $k$ . We will let  $a$  denote the number of variables that actually appear in  $x^\alpha$ .

- a. If  $x^\alpha$  appears in  $h_{k-i} \sigma_i$ , show that  $i \leq a$ . Hint: How many variables appear in each term of  $\sigma_i$ ?
- b. If  $i \leq a$ , show that exactly  $\binom{a}{i}$  terms of  $\sigma_i$  involve only variables that appear in  $x^\alpha$ . Note that all of these terms have total degree  $i$ .
- c. If  $i \leq a$ , show that  $x^\alpha$  appears in  $h_{k-i} \sigma_i$  with coefficient  $\binom{a}{i}$ . Hint: This follows from part b because  $h_{k-i}$  is the sum of all monomials of total degree  $k-i$ , and each monomial has coefficient 1.
- d. Conclude that the coefficient of  $x^\alpha$  in  $\sum_{i=0}^k (-1)^i h_{k-i} \sigma_i$  is  $\sum_{i=0}^a (-1)^i \binom{a}{i}$ . Then use the binomial theorem to show that the coefficient of  $x^\alpha$  is zero. This will complete the proof of our identity.
11. In this exercise, we will prove the identity

$$0 = h_k(x_k, \dots, x_n) + \sum_{i=1}^k (-1)^i h_{k-i}(x_k, \dots, x_n) \sigma_i(x_1, \dots, x_n)$$

used in the proof of Proposition 5. As in Exercise 10, let  $\sigma_0 = 1$ , so that the identity can be written more compactly as

$$0 = \sum_{i=0}^k (-1)^i h_{k-i}(x_k, \dots, x_n) \sigma_i(x_1, \dots, x_n)$$

The idea is to separate out the variables  $x_1, \dots, x_{k-1}$ . To this end, if  $S \subset \{1, \dots, k-1\}$ , let  $x^S$  be the product of the corresponding variables and let  $|S|$  denote the number of elements in  $S$ .

a. Prove that

$$\sigma_i(x_1, \dots, x_n) = \sum_{S \subset \{1, \dots, k-1\}} x^S \sigma_{i-|S|}(x_k, \dots, x_n),$$

where we set  $\sigma_j = 0$  if  $j < 0$ .

b. Prove that

$$\begin{aligned} & \sum_{i=0}^k (-1)^i h_{k-i}(x_k, \dots, x_n) \sigma_i(x_1, \dots, x_n) \\ &= \sum_{S \subset \{1, \dots, k-1\}} x^S \left( \sum_{i=|S|}^k (-1)^i h_{k-i}(x_k, \dots, x_n) \sigma_{i-|S|}(x_k, \dots, x_n) \right). \end{aligned}$$

c. Use Exercise 10 to conclude that the sum inside the parentheses is zero for every  $S$ . This proves the desired identity. Hint: Let  $j = i - |S|$ .

12. This exercise is concerned with the proof of Proposition 5. Let  $g_k$  be as defined in the statement of the proposition.

a. Use equation (7) to prove that  $\langle \sigma_1 - y_1, \dots, \sigma_n - y_n \rangle \subset \langle g_1, \dots, g_n \rangle$ .

b. Prove that  $\text{LT}(g_k) = x_k^k$ .

c. Combine part (b) with the results from §9 of Chapter 2 (especially Theorem 3 and Proposition 4 of that section) to prove that  $g_1, \dots, g_n$  form a Groebner basis.

13. Let  $f$  be a homogeneous symmetric polynomial of total degree  $d$ .

a. Show that  $f$  can be written as a linear combination (with coefficients in  $k$ ) of polynomials of the form  $\sigma_1^{i_1} \sigma_2^{i_2} \cdots \sigma_n^{i_n}$  where  $d = i_1 + 2i_2 + \cdots + ni_n$ .

b. Let  $m$  be the maximum degree of  $x_1$  that appears in  $f$ . By symmetry,  $m$  is the maximum degree in  $f$  of any variable. If  $\sigma_1^{i_1} \sigma_2^{i_2} \cdots \sigma_n^{i_n}$  appears in the expression of  $f$  from part (a), then prove that  $i_1 + i_2 + \cdots + i_n \leq m$ .

c. Show that the symmetric polynomial  $\sum_{i \neq j} x_i^2 x_j$  can be written as  $a\sigma_1\sigma_2 + b\sigma_3$  for some constants  $a$  and  $b$ . Then determine  $a$  and  $b$ . Compare this to what you did in Exercise 6.

14. In this exercise, you will prove the Newton identities used in the proof of Theorem 8. Let the variables be  $x_1, \dots, x_n$ .

a. As in Exercise 3, set  $\sigma_0 = 1$  and  $\sigma_i = 0$  if either  $i < 0$  or  $i > n$ . Then show that the Newton identities are equivalent to

$$s_k - \sigma_1 s_{k-1} + \cdots + (-1)^{k-1} \sigma_{k-1} s_1 + (-1)^k k \sigma_k = 0$$

for all  $k \geq 1$ .

b. Prove the identity of part (a) by induction on  $n$ . Hint: Write  $\sigma_i$  as  $\sigma_i^n$ , where the exponent denotes the number of variables, and similarly write  $s_k$  as  $s_k^n$ . Use Exercise 3, and note that  $s_k^n = s_k^{n-1} + x_k^n$ .

15. This exercise will use the identity (5) to prove the following *nonsymmetric Newton identities*:

$$\begin{aligned} x_i^k - \sigma_1 x_i^{k-1} + \cdots + (-1)^{k-1} \sigma_{k-1} x_i + (-1)^k \sigma_k &= (-1)^k \hat{\sigma}_k^i, \quad 1 \leq k < n, \\ x_i^k - \sigma_1 x_i^{k-1} + \cdots + (-1)^{n-1} \sigma_{n-1} x_i^{k-n+1} + (-1)^n \sigma_n x_i^{k-n} &= 0, \quad k \geq n, \end{aligned}$$

where  $\hat{\sigma}_k^i = \sigma_k(x_i, \dots, x_{i-1}, x_{i+1}, \dots, x_n)$  is the  $k$ -th elementary symmetric function of all variables except  $x_i$ . We will then give a second proof of the Newton identities.

- Show that the nonsymmetric Newton identity for  $k = n$  follows from (5). Then prove that this implies the nonsymmetric Newton identities for  $k \geq n$ . Hint: Treat the case  $i = n$  first.
  - Show that the nonsymmetric Newton identity for  $k = n - 1$  follows from the one for  $k = n$ . Hint:  $\sigma_n = x_i \hat{\sigma}_{n-1}^i$ .
  - Prove the nonsymmetric Newton identity for  $k < n$  by decreasing induction on  $k$ . Hint: By Exercise 3,  $\sigma_k = \hat{\sigma}_k^i + x_i \hat{\sigma}_{k-1}^i$ .
  - Prove that  $\sum_{i=1}^n \hat{\sigma}_k^i = (n-k)\hat{\sigma}_k$ . Hint: A term  $x_{i_1} \cdots x_{i_k}$ , where  $1 \leq i_1 < \cdots < i_k \leq n$ , appears in how many of the  $\hat{\sigma}_k^i$ 's?
  - Prove the Newton identities.
16. Consider the field  $\mathbb{F}_2 = \{0, 1\}$  consisting of two elements. Show that it is impossible to express the symmetric polynomial  $xy \in \mathbb{F}_2[x, y]$  as a polynomial in  $s_1$  and  $s_2$  with coefficients in  $\mathbb{F}_2$ . Hint: Show that  $s_2 = s_1^2$ !
17. Express  $s_4$  as a polynomial in  $\sigma_1, \dots, \sigma_4$  and express  $\sigma_4$  as a polynomial in  $s_1, \dots, s_4$ .
18. We can use the division algorithm to automate the process of writing a polynomial  $g(\sigma_1, \dots, \sigma_n)$  in terms of  $s_1, \dots, s_n$ . Namely, regard  $\sigma_1, \dots, \sigma_n, s_1, \dots, s_n$  as variables and consider the polynomials

$$g_k = \sigma_k = \sigma_1 \sigma_{k-1} + \cdots + (-1)^{k-1} \sigma_{k-1} s_1 + (-1)^k k \sigma_k, \quad 1 \leq k \leq n.$$

Show that if we use the correct lex order, the remainder of  $g(\sigma_1, \dots, \sigma_n)$  on division by  $g_1, \dots, g_n$  will be a polynomial  $h(s_1, \dots, s_n)$  such that  $g(\sigma_1, \dots, \sigma_n) = h(s_1, \dots, s_n)$ . Hint: The lex order you need is *not*  $\sigma_1 > \sigma_2 > \cdots > \sigma_n > s_1 > \cdots > s_n$ .

## §2 Finite Matrix Groups and Rings of Invariants

In this section, we will give some basic definitions for invariants of finite matrix groups and we will compute some examples to illustrate what questions the general theory should address. For the rest of this chapter, we will always assume that our field  $k$  contains the rational numbers  $\mathbb{Q}$ . Such fields are said to be of *characteristic zero*.

**Definition 1.** Let  $GL(n, k)$  be the set of all invertible  $n \times n$  matrices with entries in the field  $k$ .

If  $A$  and  $B$  are invertible  $n \times n$  matrices, then linear algebra implies that the product  $AB$  and inverse  $A^{-1}$  are also invertible (see Exercise 1). Also, recall that the  $n \times n$  identity matrix  $I_n$  has the properties that  $A \cdot I_n = I_n \cdot A = A$  and  $A \cdot A^{-1} = I_n$  for all  $A \in GL(n, k)$ . In the terminology of Appendix A, we say that  $GL(n, k)$  is a *group*.

Note that  $A \in GL(n, k)$  gives an invertible linear map  $A : k^n \rightarrow k^n$  via matrix multiplication. Since every linear map from  $k^n$  to itself arises in this way, it is customary to call  $GL(n, k)$  the *general linear group*.



We will be most interested in the following subsets of  $\text{GL}(n, k)$ .

**Definition 2.** A finite subset  $G \subset \text{GL}(n, k)$  is called a **finite matrix group** provided it is nonempty and closed under matrix multiplication. The number of elements of  $G$  is called the **order** of  $G$  and is denoted  $|G|$ .

Let us look at some examples of finite matrix groups.

**Example 3.** Suppose that  $A \in \text{GL}(n, k)$  is a matrix such that  $A^m = I_n$  for some positive integer  $m$ . If  $m$  is the smallest such integer, then it is easy to show that

$$C_m = \{I_n, A, \dots, A^{m-1}\} \subset \text{GL}(n, k)$$

is closed under multiplication (see Exercise 2) and, hence, is a finite matrix group. We call  $C_m$  a *cyclic group* of order  $m$ . An example is given by

$$A = \begin{pmatrix} 0 & -1 \\ 1 & 0 \end{pmatrix} \in \text{GL}(2, k).$$

One can check that  $A^4 = I_2$ , so that  $C_4 = \{I_2, A, A^2, A^3\}$  is a cyclic matrix group of order 4 in  $\text{GL}(2, k)$ .

**Example 4.** An important example of a finite matrix group comes from the permutations of variables discussed in §1. Let  $\tau$  denote a permutation  $x_{i_1}, \dots, x_{i_n}$  of  $x_1, \dots, x_n$ . Since  $\tau$  is determined by what it does to the subscripts, we will set  $i_1 = \tau(1), i_2 = \tau(2), \dots, i_n = \tau(n)$ . Then the corresponding permutation of variables is  $x_{\tau(1)}, \dots, x_{\tau(n)}$ .

We can create a matrix from  $\tau$  as follows. Consider the linear map that takes  $(x_1, \dots, x_n)$  to  $(x_{\tau(1)}, \dots, x_{\tau(n)})$ . The matrix representing this linear map is denoted  $M_\tau$  and is called a *permutation matrix*. Thus,  $M_\tau$  has the property that under matrix multiplication, it permutes the variables according to  $\tau$ :

$$M_\tau \cdot \begin{pmatrix} x_1 \\ \vdots \\ x_n \end{pmatrix} = \begin{pmatrix} x_{\tau(1)} \\ \vdots \\ x_{\tau(n)} \end{pmatrix}.$$

We leave it as an exercise to show that  $M_\tau$  is obtained from the identity matrix by permuting its columns according to  $\tau$ . More precisely, the  $\tau(i)$ -th column of  $M_\tau$  is the  $i$ -th column of  $I_n$ . As an example, consider the permutation  $\tau$  that takes  $(x, y, z)$  to  $(y, z, x)$ . Here,  $\tau(1) = 2$ ,  $\tau(2) = 3$ , and  $\tau(3) = 1$ , and one can check that

$$M_\tau \cdot \begin{pmatrix} x \\ y \\ z \end{pmatrix} = \begin{pmatrix} 0 & 1 & 0 \\ 0 & 0 & 1 \\ 1 & 0 & 0 \end{pmatrix} \begin{pmatrix} x \\ y \\ z \end{pmatrix} = \begin{pmatrix} y \\ z \\ x \end{pmatrix}.$$

Since there are  $n!$  ways to permute the variables, we get  $n!$  permutation matrices. Furthermore, this set is closed under matrix multiplication, for it is easy to show that

$$M_\tau \cdot M_\nu = M_{\nu\tau},$$

where  $v\tau$  is the permutation that takes  $i$  to  $v(\tau(i))$  (see Exercise 4). Thus, the permutation matrices form a finite matrix group in  $GL(n, k)$ . We will denote this matrix group by  $S_n$ . (Strictly speaking, the group of permutation matrices is only isomorphic to  $S_n$  in the sense of group theory. We will ignore this distinction.)

**Example 5.** Another important class of finite matrix groups comes from the symmetries of regular polyhedra. For example, consider a cube in  $\mathbb{R}^3$  centered at the origin. The set of rotations of  $\mathbb{R}^3$  that take the cube to itself is clearly finite and closed under multiplication. Thus, we get a finite matrix group in  $GL(3, \mathbb{R})$ . In general, all finite matrix groups in  $GL(3, \mathbb{R})$  have been classified, and there is a rich geometry associated with such groups (see Exercises 5–9 for some examples). To pursue this topic further, the reader should consult BENSON and GROVE (1985), KLEIN (1884), or COXETER (1973).

Finite matrix groups have the following useful properties.

**Proposition 6.** *Let  $G \subset GL(n, k)$  be a finite matrix group. Then:*

- (i)  $I_n \in G$ .
- (ii) If  $A \in G$ , then  $A^m = I_n$  for some positive integer  $m$ .
- (iii) If  $A \in G$ , then  $A^{-1} \in G$ .

**Proof.** Take  $A \in G$ . Then  $\{A, A^2, A^3, \dots\} \in G$  since  $G$  is closed under multiplication. The finiteness of  $G$  then implies that  $A^i = A^j$  for some  $i > j$ , and since  $A$  is invertible, we can multiply each side by  $A^{-j}$  to conclude that  $A^m = I_n$ , where  $m = i - j > 0$ . This proves (i) and (ii).

To prove (iii), note that (ii) implies  $I_n = A^m = A \cdot A^{m-1} = A^{m-1} \cdot A$ . Thus,  $A^{-1} = A^{m-1} \in G$  since  $G$  is closed under multiplication. As for (i), since  $G \neq \phi$ , we can pick  $A \in G$ , and then, by (ii),  $I_n = A^m \in G$ . □

We next observe that elements of  $GL(n, k)$  act on polynomials in  $k[x_1, \dots, x_n]$ . To see how this works, let  $A = (a_{ij}) \in GL(n, k)$  and  $f \in k[x_1, \dots, x_n]$ . Then

$$(1) \quad g(x_1, \dots, x_n) = f(a_{11}x_1 + \dots + a_{1n}x_n, \dots, a_{n1}x_1 + \dots + a_{nn}x_n)$$

is again a polynomial in  $k[x_1, \dots, x_n]$ . To express this more compactly, let  $\mathbf{x}$  denote the column vector of the variables  $x_1, \dots, x_n$ . Thus,

$$\mathbf{x} = \begin{pmatrix} x_1 \\ \vdots \\ x_n \end{pmatrix}.$$

Then we can use matrix multiplication to express equation (1) as

$$g(\mathbf{x}) = f(A \cdot \mathbf{x}).$$

If we think of  $A$  as a change of basis matrix, then  $g$  is simply  $f$  viewed using the new coordinates.

For an example of how this works, let  $f(x, y) = x^2 + xy + y^2 \in \mathbb{R}[x, y]$  and

$$A = \frac{1}{\sqrt{2}} \begin{pmatrix} 1 & -1 \\ 1 & 1 \end{pmatrix} \in \text{GL}(2, \mathbb{R}).$$

Then

$$\begin{aligned} g(x, y) &= f(A \cdot \mathbf{x}) = f\left(\frac{x-y}{\sqrt{2}}, \frac{x+y}{\sqrt{2}}\right) \\ &= \left(\frac{x-y}{\sqrt{2}}\right)^2 + \frac{x-y}{\sqrt{2}} \cdot \frac{x+y}{\sqrt{2}} + \left(\frac{x+y}{\sqrt{2}}\right)^2 \\ &= \frac{3}{2}x^2 + \frac{1}{2}y^2. \end{aligned}$$

Geometrically, this says that we can eliminate the  $xy$  term of  $f$  by rotating the axes  $45^\circ$ .

A remarkable fact is that sometimes this process gives back the same polynomial we started with. For example, if we let  $h(x, y) = x^2 + y^2$  and use the above matrix  $A$ , then one can check that

$$h(\mathbf{x}) = h(A \cdot \mathbf{x}).$$

In this case, we say that  $h$  is *invariant* under  $A$ .

This leads to the following fundamental definition.

**Definition 7.** Let  $G \subset \text{GL}(n, k)$  be a finite matrix group. Then a polynomial  $f(\mathbf{x}) \in k[x_1, \dots, x_n]$  is **invariant under  $G$**  if

$$f(\mathbf{x}) = f(A \cdot \mathbf{x})$$

for all  $A \in G$ . The set of all invariant polynomials is denoted  $k[x_1, \dots, x_n]^G$ .

The most basic example of invariants of a finite matrix group is given by the symmetric polynomials.

**Example 8.** If we consider the group  $S_n \subset \text{GL}(n, k)$  of permutation matrices, then it is obvious that

$$k[x_1, \dots, x_n]^{S_n} = \{\text{all symmetric polynomials in } k[x_1, \dots, x_n]\}.$$

By Theorem 3 of §1, we know that symmetric polynomials are polynomials in the elementary symmetric functions with coefficients in  $k$ . We can write this as

$$k[x_1, \dots, x_n]^{S_n} = k[\sigma_1, \dots, \sigma_n].$$

Thus, every invariant can be written as a polynomial in finitely many invariants (the elementary symmetric functions). In addition, we know that the representation in terms of the elementary symmetric functions is unique. Hence, we have a very explicit knowledge of the invariants of  $S_n$ .

One of the goals of invariant theory is to examine whether all invariants  $k[x_1, \dots, x_n]^G$  are as nice as Example 8. To begin our study of this question, we first show that the set of invariants  $k[x_1, \dots, x_n]^G$  has the following algebraic structure.

**Proposition 9.** *Let  $G \subset \text{GL}(n, k)$  be a finite matrix group. Then the set  $k[x_1, \dots, x_n]^G$  is closed under addition and multiplication and contains the constant polynomials.*

**Proof.** We leave the easy proof as an exercise. □

Multiplication and addition in  $k[x_1, \dots, x_n]^G$  automatically satisfy the distributive, associative, etc., properties since these properties are true in  $k[x_1, \dots, x_n]$ . In the terminology of Chapter 5, we say that  $k[x_1, \dots, x_n]^G$  is a *ring*. Furthermore, we say that  $k[x_1, \dots, x_n]^G$  is a *subring* of  $k[x_1, \dots, x_n]$ .

So far in this book, we have learned three ways to create new rings. In Chapter 5, we saw how to make the quotient ring  $k[x_1, \dots, x_n]/I$  of an ideal  $I \subset k[x_1, \dots, x_n]$  and the coordinate ring  $k[V]$  of an affine variety  $V \subset k^n$ . Now we can make the ring of invariants  $k[x_1, \dots, x_n]^G$  of a finite matrix group  $G \subset \text{GL}(n, k)$ . In §4, we will see how these constructions are related.

In §1, we saw that the homogeneous components of a symmetric polynomial were also symmetric. We next observe that this holds for the invariants of any finite matrix group.

**Proposition 10.** *Let  $G \subset \text{GL}(n, k)$  be a finite matrix group. Then a polynomial  $f \in k[x_1, \dots, x_n]$  is invariant under  $G$  if and only if its homogeneous components are.*

**Proof.** See Exercise 11. □

In many situations, Proposition 10 will allow us to reduce to the case of homogeneous invariants. This will be especially useful in some of the proofs given in §3.

The following lemma will prove useful in determining whether a given polynomial is invariant under a finite matrix group.

**Lemma 11.** *Let  $G \subset \text{GL}(n, k)$  be a finite matrix group and suppose that we have  $A_1, \dots, A_m \in G$  such that every  $A \in G$  can be written in the form*

$$A = B_1 B_2 \cdots B_t,$$

where  $B_i \in \{A_1, \dots, A_m\}$  for every  $i$  (we say that  $A_1, \dots, A_m$  **generate**  $G$ ). Then  $f \in k[x_1, \dots, x_n]^G$  if and only if

$$f(\mathbf{x}) = f(A_1 \cdot \mathbf{x}) = \cdots = f(A_m \cdot \mathbf{x}).$$

**Proof.** We first show that if  $f$  is invariant under matrices  $B_1, \dots, B_t$ , then it is also invariant under their product  $B_1 \cdots B_t$ . This is clearly true for  $t = 1$ . If we assume it is

true for  $t - 1$ , then

$$\begin{aligned} f((B_1 \cdots B_t) \cdot \mathbf{x}) &= f((B_1 \cdots B_{t-1}) \cdot B_t \mathbf{x}) \\ &= f(B_t \mathbf{x}) && \text{(by our inductive assumption)} \\ &= f(\mathbf{x}) && \text{(by the invariance under } B_t). \end{aligned}$$

Now suppose that  $f$  is invariant under  $A_1, \dots, A_m$ . Since elements  $A \in G$  can be written  $A = B_1 \cdots B_t$ , where every  $B_i$  is one of  $A_1, \dots, A_m$ , it follows immediately that  $f \in k[x_1, \dots, x_n]^G$ . The converse is trivial and the lemma is proved.  $\square$

We can now compute some interesting examples of rings of invariants.

**Example 12.** Consider the finite matrix group

$$V_4 = \left\{ \begin{pmatrix} \pm 1 & 0 \\ 0 & \pm 1 \end{pmatrix} \right\} \subset \text{GL}(2, k).$$

This is sometimes called the *Klein four-group*. We use the letter  $V_4$  because “four” in German is “vier.” You should check that the two matrices

$$\begin{pmatrix} -1 & 0 \\ 0 & 1 \end{pmatrix}, \quad \begin{pmatrix} 1 & 0 \\ 0 & -1 \end{pmatrix}$$

generate  $V_4$ . Then Lemma 11 implies that a polynomial  $f \in k[x, y]$  is invariant under  $V_4$  if and only if

$$f(x, y) = f(-x, y) = f(x, -y)$$

Writing  $f = \sum_{ij} a_{ij} x^i y^j$ , we can understand the first of these conditions as follows:

$$\begin{aligned} f(x, y) = f(-x, y) &\iff \sum_{ij} a_{ij} x^i y^j = \sum_{ij} a_{ij} (-x)^i y^j \\ &\iff \sum_{ij} a_{ij} x^i y^j = \sum_{ij} (-1)^i a_{ij} x^i y^j \\ &\iff a_{ij} = (-1)^i a_{ij} \quad \text{for all } i, j \\ &\iff a_{ij} = 0 \quad \text{for } i \text{ odd} \end{aligned}$$

It follows that  $x$  always appears to an even power. Similarly, the condition  $f(x, y) = f(x, -y)$  implies that  $y$  appears to even powers. Thus, we can write

$$f(x, y) = g(x^2, y^2)$$

for a unique polynomial  $g(x, y) \in k[x, y]$ . Conversely, every polynomial  $f$  of this form is clearly invariant under  $V_4$ . This proves that

$$k[x, y]^{V_4} = k[x^2, y^2].$$

Hence, every invariant of  $V_4$  can be uniquely written as a polynomial in the two

homogeneous invariants  $x^2$  and  $y^2$ . In particular, the invariants of the Klein four-group behave very much like the symmetric polynomials.

**Example 13.** For a finite matrix group that is less well-behaved, consider the cyclic group  $C_2 = \{\pm I_2\} \subset GL(2, k)$  of order 2. In this case, the invariants consist of the polynomials  $f \in k[x, y]$  for which  $f(x, y) = f(-x, -y)$ . We leave it as an exercise to show that this is equivalent to the condition

$$f(x, y) = \sum_{ij} a_{ij} x^i y^j, \quad \text{where } a_{ij} = 0 \text{ whenever } i + j \text{ is odd.}$$

This means that  $f$  is invariant under  $C_2$  if and only if the exponents of  $x$  and  $y$  always have the same parity (i.e., both even or both odd). Hence, we can write a monomial  $x^i y^j$  appearing in  $f$  in the form

$$x^i y^j = \begin{cases} x^{2k} y^{2l} = (x^2)^k (y^2)^l & \text{if } i, j \text{ are even} \\ x^{2k+1} y^{2l+1} = (x^2)^k (y^2)^l xy & \text{if } i, j \text{ are odd.} \end{cases}$$

This means that every monomial in  $f$ , and hence  $f$  itself, is a polynomial in the homogeneous invariants  $x^2, y^2$  and  $xy$ . We will write this as

$$k[x, y]^{C_2} = k[x^2, y^2, xy].$$

Note also that we need all three invariants to generate  $k[x, y]^{C_2}$ .

The ring  $k[x^2, y^2, xy]$  is fundamentally different from the previous examples because uniqueness breaks down: a given invariant can be written in terms of  $x^2, y^2, xy$  in more than one way. For example,  $x^4 y^2$  is clearly invariant under  $C_2$ , but

$$x^4 y^2 = (x^2)^2 \cdot y^2 = x^2 \cdot (xy)^2.$$

In §4, we will see that the crux of the matter is the algebraic relation  $x^2 \cdot y^2 = (xy)^2$  between the basic invariants. In general, a key part of the theory is determining all algebraic relations between invariants. Given this information, one can describe precisely how uniqueness fails.

From these examples, we see that given a finite matrix group  $G$ , invariant theory has two basic questions to answer about the ring of invariants  $k[x_1, \dots, x_n]^G$ :

- (Finite Generation) Can we find finitely many homogeneous invariants  $f_1, \dots, f_m$  such that every invariant is a polynomial in  $f_1, \dots, f_m$ ?
- (Uniqueness) In how many ways can an invariant be written in terms of  $f_1, \dots, f_m$ ?

In §4, we will see that this asks for the algebraic relations among  $f_1, \dots, f_m$ .

In §§3 and 4, we will give complete answers to both questions. We will also describe algorithms for finding the invariants and the relations between them.

### EXERCISES FOR §2

1. If  $A, B \in GL(n, k)$  are invertible matrices, show that  $AB$  and  $A^{-1}$  are also invertible.
2. Suppose that  $A \in GL(n, k)$  satisfies  $A^m = I_n$  for some positive integer. If  $m$  is the smallest such integer, then prove that the set  $C_m = \{I_n, A, A^2, \dots, A^{m-1}\}$  has exactly  $m$  elements and is closed under matrix multiplication.

3. Write down the six permutation matrices in  $GL(3, k)$ .
4. Let  $M_\tau$  be the matrix of the linear transformation taking  $x_1, \dots, x_n$  to  $x_{\tau(1)}, \dots, x_{\tau(n)}$ . This means that if  $e_1, \dots, e_n$  is the standard basis of  $k^n$ , then  $M_\tau \cdot (\sum_j x_j e_j) = \sum_j x_{\tau(j)} e_j$ .
  - a. Show that  $M_\tau \cdot e_{\tau(i)} = e_i$ . Hint: Observe that  $\sum_j x_j e_j = \sum_j x_{\tau(j)} e_{\tau(j)}$ .
  - b. Prove that the  $\tau(i)$ -th column of  $M_\tau$  is the  $i$ -th column of the identity matrix.
  - c. Prove that  $M_\tau \cdot M_\nu = M_{\nu\tau}$ , where  $\nu\tau$  is the permutation taking  $i$  to  $\nu(\tau(i))$ .
5. Consider a cube in  $\mathbb{R}^3$  centered at the origin whose edges have length 2 and are parallel to the coordinate axes.
  - a. Show that there are finitely many rotations of  $\mathbb{R}^3$  about the origin which take the cube to itself and show that these rotations are closed under composition. Taking the matrices representing these rotations, we get a finite matrix group  $G \subset GL(3, \mathbb{R})$ .
  - b. Show that  $G$  has 24 elements. Hint: Every rotation is a rotation about a line through the origin. So you first need to identify the “lines of symmetry” of the cube.
  - c. Write down the matrix of the element of  $G$  corresponding to the  $120^\circ$  counterclockwise rotation of the cube about the diagonal connecting the vertices  $(-1, -1, -1)$  and  $(1, 1, 1)$ .
  - d. Write down the matrix of the element of  $G$  corresponding to the  $90^\circ$  counterclockwise rotation about the  $z$ -axis.
  - e. Argue geometrically that  $G$  is generated by the two matrices from parts (c) and (d).
6. In this exercise, we will use geometric methods to find some invariants of the rotation group  $G$  of the cube (from Exercise 5).
  - a. Explain why  $x^2 + y^2 + z^2 \in \mathbb{R}[x, y, z]^G$ . Hint: Think geometrically in terms of distance to the origin.
  - b. Argue geometrically that the union of the three coordinate planes  $\mathbf{V}(xyz)$  is invariant under  $G$ .
  - c. Show that  $\mathbf{I}(\mathbf{V}(xyz)) = \langle xyz \rangle$  and conclude that if  $f = xyz$ , then for each  $A \in G$ , we have  $f(A \cdot \mathbf{x}) = axyz$  for some real number  $a$ .
  - d. Show that  $f = xyz$  satisfies  $f(A \cdot \mathbf{x}) = \pm xyz$  for all  $A \in G$  and conclude that  $x^2 y^2 z^2 \in k[x, y, z]^G$ . Hint: Use part (c) and the fact that  $A^m = I_3$  for some positive integer  $m$ .
  - e. Use similar methods to show that the polynomials
 
$$\left( (x+y+z)(x+y-z)(x-y+z)(x-y-z) \right)^2, \left( (x^2-y^2)(x^2-z^2)(y^2-z^2) \right)^2$$
 are in  $k[x, y, z]^G$ . Hint: The plane  $x+y+z=0$  is perpendicular to one of the diagonals of the cube.
7. This exercise will continue our study of the invariants of the rotation group  $G$  of the cube begun in Exercise 6.
  - a. Show that a polynomial  $f$  is in  $k[x, y, z]^G$  if and only if  $f(x, y, z) = f(y, z, x) = f(-y, x, z)$ . Hint: Use parts (c), (d), and (e) of Exercise 5.
  - b. Let
 
$$f = xyz,$$

$$g = (x+y+z)(x+y-z)(z-y+z)(x-y-z),$$

$$h = (x^2-y^2)(x^2-z^2)(y^2-z^2).$$
 In Exercise 6, we showed that  $f^2, g^2, h^2 \in k[x, y, z]^G$ . Show that  $f, h \notin k[x, y, z]^G$ , but  $g, fh \in k[x, y, z]^G$ . Combining this with the previous exercise, we have invariants  $x^2 + y^2 + z^2, g, f^2, fh$ , and  $h^2$  of degrees 2, 4, 6, 9, and 12, respectively, in  $k[x, y, z]^G$ . In §3, we will see that  $h^2$  can be expressed in terms of the others.
8. In this exercise, we will consider an interesting “duality” that occurs among the regular polyhedra.

- a. Consider a cube and an octahedron in  $\mathbb{R}^3$ , both centered at the origin. Suppose the edges of the cube are parallel to the coordinate axes and the vertices of the octahedron are on the axes. Show that they have the same group of rotations. Hint: Put the vertices of the octahedron at the centers of the faces of the cube.
  - b. Show that the dodecahedron and the icosahedron behave the same way. Hint: What do you get if you link up the centers of the 12 faces of the dodecahedron?
  - c. Parts (a) and (b) show that in a certain sense, the “dual” of the cube is the octahedron and the “dual” of the dodecahedron is the icosahedron. What is the “dual” of the tetrahedron?
9. (Requires abstract algebra) In this problem, we will consider a tetrahedron centered at the origin of  $\mathbb{R}^3$ .
- a. Show that the rotations of  $\mathbb{R}^3$  about the origin which take the tetrahedron to itself give us a finite matrix group  $G$  of order 12 in  $GL(3, \mathbb{R})$ .
  - b. Since every rotation of the tetrahedron induces a permutation of the four vertices, show that we get a group homomorphism  $\rho : G \rightarrow S_4$ .
  - c. Show that  $\rho$  is injective and that its image is the alternating group  $A_4$ . This shows that the rotation group of the tetrahedron is isomorphic in  $A_4$ .
10. Prove Proposition 9.
11. Prove Proposition 10. Hint: If  $A = (a_{ij}) \in GL(n, k)$  and  $x_1^{i_1} \cdots x_n^{i_n}$  is a monomial of total degree  $k = i_1 + \cdots + i_n$  appearing in  $f$ , then show that

$$(a_{11}x_1 + \cdots + a_{1n}x_n)^{i_1} \cdots (a_{n1}x_1 + \cdots + a_{nn}x_n)^{i_n}$$

is homogeneous of total degree  $k$ .

12. In Example 13, we studied polynomials  $f \in k[x, y]$  with the property that  $f(x, y) = f(-x, -y)$ . If  $f = \sum_{i,j} a_{ij}x^i y^j$ , show that the above condition is equivalent to  $a_{ij} = 0$  whenever  $i + j$  is odd.
13. In Example 13, we discovered the algebraic relation  $x^2 \cdot y^2 = (xy)^2$  between the invariants  $x^2, y^2$ , and  $xy$ . We want to show that this is essentially the only relation. More precisely, suppose that we have a polynomial  $g(u, v, w) \in k[u, v, w]$  such that  $g(x^2, y^2, xy) = 0$ . We want to prove that  $g(u, v, w)$  is a multiple (in  $k[u, v, w]$ ) of  $uv - w^2$  (which is the polynomial corresponding to the above relation).
  - a. If we divide  $g$  by  $uv - w^2$  using lex order with  $u > v > w$ , show that the remainder can be written in the form  $uA(u, w) + vB(v, w) + C(w)$ .
  - b. Show that a polynomial  $r = uA(u, w) + vB(v, w) + C(w)$  satisfies  $r(x^2, y^2, xy) = 0$  if and only if  $r = 0$ .
14. Consider the finite matrix group  $C_4 \subset GL(2, \mathbb{C})$  generated by

$$A = \begin{pmatrix} i & 0 \\ 0 & -i \end{pmatrix} \in GL(2, \mathbb{C})$$

- a. Prove that  $C_4$  is cyclic of order 4.
  - b. Use the method of Example 13 to determine  $\mathbb{C}[x, y]^{C_4}$ .
  - c. Is there an algebraic relation between the invariants you found in part (b)? Can you give an example to show how uniqueness fails?
  - d. Use the method of Exercise 13 to show that the relation found in part (c) is the only relation between the invariants.
15. Consider

$$V_4 = \left\{ \pm \begin{pmatrix} 1 & 0 \\ 0 & 1 \end{pmatrix}, \pm \begin{pmatrix} 0 & 1 \\ 1 & 0 \end{pmatrix} \right\} \subset GL(2, k)$$



- a. Show that  $V_4$  is a finite matrix group of order 4.
- b. Determine  $k[x, y]^{V_4}$ .
- c. Show that any invariant can be written uniquely in terms of the generating invariants you found in part (b).

16. In Example 3, we introduced the finite matrix group  $C_4$  in  $GL(2, k)$  generated by

$$A = \begin{pmatrix} 0 & -1 \\ 1 & 0 \end{pmatrix} \in GL(2, k).$$

Try to apply the methods of Examples 12 and 13 to determine  $k[x, y]^{C_4}$ . Even if you cannot find all of the invariants, you should be able to find some invariants of low total degree. In §3, we will determine  $k[x, y]^{C_4}$  completely.

### §3 Generators for the Ring of Invariants

The goal of this section is to determine, in an algorithmic fashion, the ring of invariants  $k[x_1, \dots, x_n]^G$  of a finite matrix group  $G \subset GL(n, k)$ . As in §2, we assume that our field  $k$  has characteristic zero. We begin by introducing some terminology used implicitly in §2.

**Definition 1.** Given  $f_1, \dots, f_m \in k[x_1, \dots, x_n]$ , we let  $k[f_1, \dots, f_m]$  denote the subset of  $k[x_1, \dots, x_n]$  consisting of all polynomial expressions in  $f_1, \dots, f_m$  with coefficients in  $k$ .

This means that the elements  $f \in k[f_1, \dots, f_m]$  are those polynomials which can be written in the form

$$f = g(f_1, \dots, f_m),$$

where  $g$  is a polynomial in  $m$  variables with coefficients in  $k$ .

Since  $k[f_1, \dots, f_m]$  is closed under multiplication and addition and contains the constants, it is a subring of  $k[x_1, \dots, x_n]$ . We say that  $k[f_1, \dots, f_m]$  is *generated by*  $f_1, \dots, f_m$  *over*  $k$ . One has to be slightly careful about the terminology: the subring  $k[f_1, \dots, f_m]$  and the ideal  $\langle f_1, \dots, f_m \rangle$  are both “generated” by  $f_1, \dots, f_m$ , but in each case, we mean something slightly different. In the exercises, we will give some examples to help explain the distinction.

An important tool we will use in our study of  $k[x_1, \dots, x_n]^G$  is the *Reynolds operator*, which is defined as follows.

**Definition 2.** Given a finite matrix group  $G \subset GL(n, k)$ , the **Reynolds operator** of  $G$  is the map  $R_G : k[x_1, \dots, x_n] \rightarrow k[x_1, \dots, x_n]$  defined by the formula

$$R_G(f)(\mathbf{x}) = \frac{1}{|G|} \sum_{A \in G} f(A \cdot \mathbf{x})$$

for  $f(\mathbf{x}) \in k[x_1, \dots, x_n]$ .

One can think of  $R_G(f)$  as “averaging” the effect of  $G$  on  $f$ . Note that division by  $|G|$  is allowed since  $k$  has characteristic zero. The Reynolds operator has the following crucial properties.

**Proposition 3.** *Let  $R_G$  be the Reynolds operator of the finite matrix group  $G$ .*

- (i)  $R_G$  is  $k$ -linear in  $f$ .
- (ii) If  $f \in k[x_1, \dots, x_n]$ , then  $R_G(f) \in k[x_1, \dots, x_n]^G$ .
- (iii) If  $f \in k[x_1, \dots, x_n]^G$ , then  $R_G(f) = f$ .

**Proof.** We will leave the proof of (i) as an exercise. To prove (ii), let  $B \in G$ . Then

$$(1) \quad R_G(f)(B\mathbf{x}) = \frac{1}{|G|} \sum_{A \in G} f(A \cdot B\mathbf{x}) = \frac{1}{|G|} \sum_{A \in G} f(AB \cdot \mathbf{x}).$$

Writing  $G = \{A_1, \dots, A_{|G|}\}$ , note that  $A_i B \neq A_j B$  when  $i \neq j$  (otherwise, we could multiply each side by  $B^{-1}$  to conclude that  $A_i = A_j$ ). Thus the subset  $\{A_1 B, \dots, A_{|G|} B\} \subset G$  consists of  $|G|$  distinct elements of  $G$  and hence must equal  $G$ . This shows that

$$G = \{AB : A \in G\}.$$

Consequently, in the last sum of (1), the polynomials  $f(AB \cdot \mathbf{x})$  are just the  $f(A \cdot \mathbf{x})$ , possibly in a different order. Hence,

$$\frac{1}{|G|} \sum_{A \in G} f(AB \cdot \mathbf{x}) = \frac{1}{|G|} \sum_{A \in G} f(A \cdot \mathbf{x}) = R_G(f)(\mathbf{x}),$$

and it follows that  $R_G(f)(B \cdot \mathbf{x}) = R_G(f)(\mathbf{x})$  for all  $B \in G$ . This implies  $R_G(f) \in k[x_1, \dots, x_n]^G$ .

Finally, to prove (iii), note that if  $f \in k[x_1, \dots, x_n]^G$ , then

$$R_G(f)(\mathbf{x}) = \frac{1}{|G|} \sum_{A \in G} f(A \cdot \mathbf{x}) = \frac{1}{|G|} \sum_{A \in G} f(\mathbf{x}) = f(\mathbf{x})$$

since  $f$  invariant. This completes the proof. □

One nice aspect of this proposition is that it gives us a way of creating invariants. Let us look at an example.

**Example 4.** Consider the cyclic matrix group  $C_4 \subset GL(2, k)$  of order 4 generated by

$$A = \begin{pmatrix} 0 & -1 \\ 1 & 0 \end{pmatrix}.$$

By Lemma 11 of §2, we know that

$$k[x, y]^{C_4} = \{f \in k[x, y] : f(x, y) = f(-y, x)\}.$$

One can easily check that the Reynolds operator is given by

$$R_{C_4}(f)(x, y) = \frac{1}{4}(f(x, y) + f(-y, x) + f(-x, -y) + f(y, -x))$$

(see Exercise 3). Using Proposition 3, we can compute some invariants as follows:

$$\begin{aligned} R_{C_4}(x^2) &= \frac{1}{4}(x^2 + (-y)^2 + (-x)^2 + y^2) = \frac{1}{2}(x^2 + y^2), \\ R_{C_4}(xy) &= \frac{1}{4}(xy + (-y)x + (-x)(-y) + y(-x)) = 0, \\ R_{C_4}(x^3y) &= \frac{1}{4}(x^3y + (-y)^3x + (-x)^3(-y) + y^3(-x)) = \frac{1}{2}(x^3y - xy^3), \\ R_{C_4}(x^2y^2) &= \frac{1}{4}(x^2y^2 + (-y)^2x^2 + (-x)^2(-y)^2 + y^2(-x)^2) = x^2y^2. \end{aligned}$$

Thus,  $x^2 + y^2, x^3y - xy^3, x^2y^2 \in k[x, y]^{C_4}$ . We will soon see that these three invariants generate  $k[x, y]^{C_4}$ .

It is easy to prove that for any monomial  $x^\alpha$ , the Reynolds operator gives us a homogeneous invariant  $R_G(x^\alpha)$  of total degree  $|\alpha|$  whenever it is nonzero. The following wonderful theorem of Emmy Noether shows that we can always find finitely many of these invariants that generate  $k[x_1, \dots, x_n]^G$ .

**Theorem 5.** *Given a finite matrix group  $G \subset \text{GL}(n, k)$ , we have*

$$k[x_1, \dots, x_n]^G = k[R_G(x^\beta) : |\beta| \leq |G|].$$

*In particular,  $k[x_1, \dots, x_n]^G$  is generated by finitely many homogeneous invariants.*

**Proof.** If  $f = \sum_{\alpha} c_{\alpha} x^{\alpha} \in k[x_1, \dots, x_n]^G$ , then Proposition 3 implies that

$$f = R_G(f) = R_G\left(\sum_{\alpha} c_{\alpha} x^{\alpha}\right) = \sum_{\alpha} c_{\alpha} R_G(x^{\alpha}).$$

Hence every invariant is a linear combination (over  $k$ ) of the  $R_G(x^\alpha)$ . Consequently, it suffices to prove that for all  $\alpha$ ,  $R_G(x^\alpha)$  is a polynomial in the  $R_G(x^\beta)$ ,  $|\beta| \leq |G|$ .

Noether's clever idea was to fix an integer  $l$  and combine all  $R_G(x^\beta)$  of total degree  $l$  into a power sum of the type considered in §1. Using the theory of symmetric functions, this can be expressed in terms of finitely many power sums, and the theorem will follow.

The first step in implementing this strategy is to expand  $(x_1 + \dots + x_n)^l$  into a sum of monomials  $x^\alpha$  with  $|\alpha| = l$ :

$$(2) \quad (x_1 + \dots + x_n)^l = \sum_{|\alpha|=l} a_{\alpha} x^{\alpha}.$$

In Exercise 4, you will prove that  $a_{\alpha}$  is a positive integer for all  $|\alpha| = l$ .

To exploit this identity, we need some notation. Given  $A = (a_{ij}) \in G$ , let  $A_i$  denote the  $i$ -th row of  $A$ . Thus,  $A_i \cdot \mathbf{x} = a_{i1}x_1 + \dots + a_{in}x_n$ . Then, if  $\alpha = (\alpha_1, \dots, \alpha_n) \in \mathbb{Z}_{\geq 0}^n$ , let

$$(A \cdot \mathbf{x})^{\alpha} = (A_1 \cdot \mathbf{x})^{\alpha_1} \cdots (A_n \cdot \mathbf{x})^{\alpha_n}.$$

In this notation, we have

$$R_G(x^\alpha) = \frac{1}{|G|} \sum_{A \in G} (A \cdot \mathbf{x})^\alpha.$$

Now introduce new variables  $u_1, \dots, u_n$  and substitute  $u_i A_i \cdot \mathbf{x}$  for  $x_i$  in (2). This gives the identity

$$(u_1 A_1 \cdot \mathbf{x} + \dots + u_n A_n \cdot \mathbf{x})^l = \sum_{|\alpha|=l} a_\alpha (A \cdot \mathbf{x})^\alpha u^\alpha.$$

If we sum over all  $A \in G$ , then we obtain

$$\begin{aligned} (3) \quad S_l &= \sum_{A \in G} (u_1 A_1 \cdot \mathbf{x} + \dots + u_n A_n \cdot \mathbf{x})^l = \sum_{|\alpha|=l} a_\alpha \left( \sum_{A \in G} (A \cdot \mathbf{x})^\alpha \right) u^\alpha \\ &= \sum_{|\alpha|=l} b_\alpha R_G(x^\alpha) u^\alpha, \end{aligned}$$

where  $b_\alpha = |G|a_\alpha$ . Note how the sum on the right encodes *all*  $R_G(x^\alpha)$  with  $|\alpha| = l$ . This is why we use the variables  $u_1, \dots, u_n$ : they prevent any cancellation from occurring.

The left side of (3) is the  $l$ -th power sum  $S_l$  of the  $|G|$  quantities

$$U_A = u_1 A_1 \cdot \mathbf{x} + \dots + u_n A_n \cdot \mathbf{x}$$

indexed by  $A \in G$ . We write this as  $S_l = S_l(U_A : A \in G)$ . By Theorem 8 of §1, every symmetric function in the  $|G|$  quantities  $U_A$  is a polynomial in  $S_1, \dots, S_{|G|}$ . Since  $S_l$  is symmetric in the  $U_A$ , it follows that

$$S_l = F(S_1, \dots, S_{|G|})$$

for some polynomial  $F$  with coefficients in  $l$ . Substituting in (3), we obtain

$$\sum_{|\alpha|=l} b_\alpha R_G(x^\alpha) u^\alpha = F \left( \sum_{|\beta|=1} b_\beta R_G(x^\beta) u^\beta, \dots, \sum_{|\beta|=|G|} R_G(x^\beta) u^\beta \right).$$

Expanding the right side and equating the coefficients of  $u^\alpha$ , it follows that

$$b_\alpha R_G(x^\alpha) = \text{a polynomial in the } R_G(x^\beta), \quad |\beta| \leq |G|.$$

Since  $k$  has characteristic zero, the coefficient  $b_\alpha = |G|a_\alpha$  is nonzero in  $k$ , and hence  $R_G(x^\alpha)$  has the desired form. This completes the proof of the theorem.  $\square$

This theorem solves the *finite generation problem* stated at the end of §2. In the exercises, you will give a second proof of the theorem using the Hilbert Basis Theorem.

To see the power of what we have just proved, let us compute some invariants.

**Example 6.** We will return to the cyclic group  $C_4 \subset GL(2, k)$  of order 4 from Example 4. To find the ring of invariants, we need to compute  $R_{C_4}(x^i y^j)$  for all  $i + j \leq 4$ . The following table records the results:

$x^i y^j$	$R_{C_4}(x^i y^j)$	$x^i y^j$	$R_{C_4}(x^i y^j)$
$x$	0	$xy^2$	0
$y$	0	$y^3$	0
$x^2$	$\frac{1}{2}(x^2 + y^2)$	$x^4$	$\frac{1}{2}(x^4 + y^4)$
$xy$	0	$x^3 y$	$\frac{1}{2}(x^3 y - xy^3)$
$y^2$	$\frac{1}{2}(x^2 + y^2)$	$x^2 y^2$	$x^2 y^2$
$x^3$	0	$xy^3$	$-\frac{1}{2}(x^3 y - xy^3)$
$x^2 y$	0	$y^4$	$\frac{1}{2}(x^4 + y^4)$

By Theorem 5, it follows that  $k[x, y]^{C_4}$  is generated by the four invariants  $x^2 + y^2, x^4 + y^4, x^3 y - xy^3$  and  $x^2 y^2$ . However, we do not need  $x^4 + y^4$  since

$$x^4 + y^4 = (x^2 + y^2)^2 - 2x^2 y^2.$$

Thus, we have proved that

$$k[x, y]^{C_4} = k[x^2 + y^2, x^3 y - xy^3, x^2 y^2].$$

The main drawback of Theorem 5 is that when  $|G|$  is large, we need to compute the Reynolds operator for *lots* of monomials. For example, consider the cyclic group  $C_8 \subset GL(2, \mathbb{R})$  of order 8 generated by the  $45^\circ$  rotation

$$A = \frac{1}{\sqrt{2}} \begin{pmatrix} 1 & -1 \\ 1 & 1 \end{pmatrix} \in GL(2, \mathbb{R}).$$

In this case, Theorem 5 says that  $k[x, y]^{C_8}$  is generated by the 44 invariants  $R_{C_8}(x^i y^j), i + j \leq 8$ . In reality, only 3 are needed. For larger groups, things are even worse, especially if more variables are involved. See Exercise 10 for an example.

Fortunately, there are more efficient methods for finding a generating set of invariants. The main tool is *Molien's Theorem*, which enables one to predict in advance the number of linearly independent homogeneous invariants of given total degree. This theorem can be found in Chapter 7 of BENSON and GROVE (1985) and Chapter 2 of STURMFELS (1993). The latter also gives an efficient algorithm, based on Molien's Theorem, for finding invariants that generate  $k[x_1, \dots, x_n]^G$ .

Once we know  $k[x_1, \dots, x_n]^G = k[f_1, \dots, f_m]$ , we can ask if there is an algorithm for writing a given invariant  $f \in k[x_1, \dots, x_n]^G$  in terms of  $f_1, \dots, f_m$ . For example, it is easy to check that the polynomial

$$(4) \quad f(x, y) = x^8 + 2x^6 y^2 - x^5 y^3 + 2x^4 y^4 + x^3 y^5 + 2x^2 y^6 + y^8$$

satisfies  $f(x, y) = f(-y, x)$ , and hence is invariant under the group  $C_4$  from Example 4. Then Example 6 implies that  $f \in k[x, y]^{C_4} = k[x^2 + y^2, x^3y - xy^3, x^2y^2]$ . But how do we write  $f$  in terms of these three invariants? To answer this question, we will use a method similar to what we did in Proposition 4 of §1.

We will actually prove a bit more, for we will allow  $f_1, \dots, f_m$  to be arbitrary elements of  $k[x_1, \dots, x_n]$ . The following proposition shows how to test whether a polynomial lies in  $k[f_1, \dots, f_m]$  and, if so, to write it in terms of  $f_1, \dots, f_m$ .

**Proposition 7.** *Suppose that  $f_1, \dots, f_m \in k[x_1, \dots, x_n]$  are given. Fix a monomial order in  $k[x_1, \dots, x_n, y_1, \dots, y_m]$  where any monomial involving one of  $x_1, \dots, x_n$  is greater than all monomials in  $k[y_1, \dots, y_m]$ . Let  $G$  be a Groebner basis of the ideal  $\langle f_1 - y_1, \dots, f_m - y_m \rangle \subset k[x_1, \dots, x_n, y_1, \dots, y_m]$ . Given  $f \in k[x_1, \dots, x_n]$ , let  $g = \overline{f}^G$  be the remainder of  $f$  on division by  $G$ . Then:*

- (i)  $f \in k[f_1, \dots, f_m]$  if and only if  $g \in k[y_1, \dots, y_m]$ .
- (ii) If  $f \in k[f_1, \dots, f_m]$ , then  $f = g(f_1, \dots, f_m)$  is an expression of  $f$  as a polynomial in  $f_1, \dots, f_m$ .

**Proof.** The proof will be similar to the argument given in Proposition 4 of §1 (with one interesting difference). When we divide  $f \in k[x_1, \dots, x_n]$  by  $G = \{g_1, \dots, g_t\}$ , we get an expression of the form

$$f = A_1g_1 + \dots + A_tg_t + g.$$

with  $A_1, \dots, A_t, g \in k[x_1, \dots, x_n, y_1, \dots, y_m]$ .

To prove (i), first suppose that  $g \in k[y_1, \dots, y_m]$ . Then for each  $i$ , substitute  $f_i$  for  $y_i$  in the above formula for  $f$ . This substitution will not affect  $f$  since it involves only  $x_1, \dots, x_n$ , but it sends every polynomial in  $\langle f_1 - y_1, \dots, f_m - y_m \rangle$  to zero. Since  $g_1, \dots, g_t$  lie in this ideal, it follows that  $f = g(f_1, \dots, f_m)$ . Hence,  $f \in k[f_1, \dots, f_m]$ .

Conversely, suppose that  $f = g(f_1, \dots, f_m)$  for some  $g \in k[y_1, \dots, y_m]$ . Arguing as in §1, one sees that

$$(5) \quad f = C_1 \cdot (f_1 - y_1) + \dots + C_m \cdot (f_m - y_m) + g(y_1, \dots, y_m)$$

[see equation (4) of §1]. Unlike the case of symmetric polynomials,  $g$  need not be the remainder of  $f$  on division by  $G$ —we still need to reduce some more.

Let  $G' = G \cap k[y_1, \dots, y_m]$  consist of those elements of  $G$  involving only  $y_1, \dots, y_m$ . Renumbering if necessary, we can assume  $G' = \{g_1, \dots, g_s\}$ , where  $s \leq t$ . If we divide  $g$  by  $G'$ , we get an expression of the form

$$(6) \quad g = B_1g_1 + \dots + B_s g_s + g',$$

where  $B_1, \dots, B_s, g' \in k[y_1, \dots, y_m]$ . If we combine equations (5) and (6), we can

write  $f$  in the form

$$f = C'_1 \cdot (f_1 - y_1) + \cdots + C'_m \cdot (f_m - y_m) + g'(y_1, \dots, y_m).$$

This follows because, in (6), each  $g_i$  lies in  $\langle f_1 - y_1, \dots, f_m - y_m \rangle$ . We claim that  $g'$  is the remainder of  $f$  on division by  $G$ . This will prove that the remainder lies in  $k[y_1, \dots, y_m]$ .

Since  $G$  a Groebner basis, Proposition 1 of Chapter 2, §6 tells us that  $g'$  is the remainder of  $f$  on division by  $G$  provided that no term of  $g'$  is divisible by an element of  $\text{LT}(G)$ . To prove that  $g'$  has this property, suppose that there is  $g_i \in G$  where  $\text{LT}(g_i)$  divides some term of  $g'$ . Then  $\text{LT}(g_i)$  involves only  $y_1, \dots, y_m$  since  $g' \in k[y_1, \dots, y_m]$ . By our hypothesis on the ordering, it follows that  $g_i \in k[y_1, \dots, y_m]$  and hence,  $g_i \in G'$ . Since  $g'$  is a remainder on division by  $G'$ ,  $\text{LT}(g_i)$  cannot divide any term of  $g'$ . This contradiction shows that  $g'$  is the desired remainder.

Part (ii) of the proposition follows immediately from the above arguments, and we are done.  $\square$

In the exercises, you will use this proposition to write the polynomial

$$f(x, y) = x^8 + 2x^6y^2 - x^5y^3 + 2x^4y^4 + x^3y^5 + 2x^2y^6 + y^8$$

from (4) in terms of the generating invariants  $x^2 + y^2, x^3y - xy^3, x^2y^2$  of  $k[x, y]^{C_4}$ .

The problem of finding generators for the ring of invariants (and the associated problem of finding the relations between them—see §4) played an important role in the development of invariant theory. Originally, the group involved was the group of all invertible matrices over a field. A classic introduction can be found in HILBERT (1993), and STURMFELS (1993) also discusses this case. For more on the invariant theory of finite groups, we recommend BENSON (1993), BENSON and GROVE (1985), SMITH (1995) and STURMFELS (1993).

### EXERCISES FOR §3

- Given  $f_1, \dots, f_m \in k[x_1, \dots, x_n]$ , we can “generate” the following two objects:
  - The ideal  $\langle f_1, \dots, f_m \rangle \subset k[x_1, \dots, x_n]$  generated by  $f_1, \dots, f_m$ . This consists of all expressions  $\sum_{i=1}^m h_i f_i$ , where  $h_1, \dots, h_m \in k[x_1, \dots, x_n]$ .
  - The subring  $k[f_1, \dots, f_m] \subset k[x_1, \dots, x_n]$  generated by  $f_1, \dots, f_m$  over  $k$ . This consists of all expressions  $g(f_1, \dots, f_m)$  where  $g$  is a polynomial in  $m$  variables with coefficients in  $k$ .

To illustrate the differences between these, we will consider the simple case where  $f_1 = x^2 \in k[x]$ .

  - Explain why  $1 \in k[x^2]$  but  $1 \notin \langle x^2 \rangle$ .
  - Explain why  $x^3 \notin k[x^2]$  but  $x^3 \in \langle x^2 \rangle$ .
- Let  $G$  be a finite matrix group in  $\text{GL}(n, k)$ . Prove that the Reynolds operator  $R_G$  has the following properties:
  - If  $a, b \in k$  and  $f, g \in k[x_1, \dots, x_n]$ , then  $R_G(af + bg) = aR_G(f) + bR_G(g)$ .
  - $R_G$  maps  $k[x_1, \dots, x_n]$  to  $k[x_1, \dots, x_n]^G$  and is onto.
  - $R_G \circ R_G = R_G$ .
  - If  $f \in k[x_1, \dots, x_n]^G$  and  $g \in k[x_1, \dots, x_n]$ , then  $R_G(fg) = f \cdot R_G(g)$ .

3. In this exercise, we will work with the cyclic group  $C_4 \subset \text{GL}(2, k)$  from Example 4 in the text.
- a. Prove that the Reynolds operator of  $C_4$  is given by

$$R_{C_4}(f)(x, y) = \frac{1}{4}(f(x, y) + f(-y, x) + f(-x, -y) + f(y, -x)).$$

- b. Compute  $R_{C_4}(x^i y^j)$  for all  $i + j \leq 4$ . Note that some of the computations are done in Example 4. You can check your answers against the table in Example 6.
4. In this exercise, we will study the identity (2) used in the proof of Theorem 5. We will use the *multinomial coefficients*, which are defined as follows. For  $\alpha = (\alpha_1, \dots, \alpha_n) \in \mathbb{Z}_{\geq 0}^n$ , let  $|\alpha| = k$  and define

$$\binom{k}{\alpha} = \frac{k!}{\alpha_1! \alpha_2! \cdots \alpha_n!}.$$

- a. Prove that  $\binom{k}{\alpha}$  is an integer. Hint: Use induction on  $n$  and note that when  $n = 2$ ,  $\binom{k}{\alpha}$  is a binomial coefficient.
- b. Prove that

$$(x_1 + \cdots + x_n)^k = \sum_{|\alpha|=k} \binom{k}{\alpha} x^\alpha.$$

In particular, the coefficient  $a_\alpha$  in equation (2) is the positive integer  $\binom{k}{\alpha}$ . Hint: Use induction on  $n$  and note that the case  $n = 2$  is the binomial theorem.

5. Let  $G \subset \text{GL}(n, k)$  be a finite matrix group. In this exercise, we will give Hilbert's proof that  $k[x_1, \dots, x_n]^G$  is generated by finitely many homogeneous invariants. To begin the argument, let  $I \subset k[x_1, \dots, x_n]$  be the *ideal* generated by all homogeneous invariants of positive total degree.
- a. Explain why there are finitely many homogeneous invariants  $f_1, \dots, f_m$  such that  $I = \langle f_1, \dots, f_m \rangle$ . The strategy of Hilbert's proof is to show that  $k[x_1, \dots, x_n]^G = k[f_1, \dots, f_m]$ . Since the inclusion  $k[f_1, \dots, f_m] \subset k[x_1, \dots, x_n]^G$  is obvious, we must show that  $k[x_1, \dots, x_n]^G \not\subset k[f_1, \dots, f_m]$  leads to a contradiction.
- b. Prove that  $k[x_1, \dots, x_n]^G \not\subset k[f_1, \dots, f_m]$  implies there is a homogeneous invariant  $f$  of positive degree which is not in  $k[f_1, \dots, f_m]$ .
- c. For the rest of the proof, pick  $f$  as in part (b) with *minimal* total degree  $d$ . By definition,  $f \in I$ , so that  $f = \sum_{i=1}^m h_i f_i$  for  $h_1, \dots, h_m \in k[x_1, \dots, x_n]$ . Prove that for each  $i$ , we can assume  $h_i f_i$  is 0 or homogeneous of total degree  $k$ .
- d. Use the Reynolds operator to show that  $f = \sum_{i=1}^m R_G(h_i) f_i$ . Hint: Use Proposition 3 and Exercise 2. Also show that for each  $i$ ,  $R_G(h_i) f_i$  is 0 or homogeneous of total degree  $d$ .
- e. Since  $f_i$  has positive total degree, conclude that  $R_G(h_i)$  is a homogeneous invariant of total degree  $< d$ . By the minimality of  $k$ ,  $R_G(h_i) \in k[f_1, \dots, f_m]$  for all  $i$ . Prove that this contradicts  $f \notin k[f_1, \dots, f_m]$ .

This proof is a lovely application of the Hilbert Basis Theorem. The one drawback is that it does not tell us how to find the generators—the proof is purely nonconstructive. Thus, for our purposes, Noether's theorem is much more useful.

6. If we have two finite matrix groups  $G$  and  $H$  such that  $G \subset H \subset \text{GL}(n, k)$ , prove that  $k[x_1, \dots, x_n]^H \subset k[x_1, \dots, x_n]^G$ .
7. Consider the matrix

$$A = \begin{pmatrix} 0 & -1 \\ 1 & -1 \end{pmatrix} \in \text{GL}(2, k).$$



- a. Show that  $A$  generates a cyclic matrix group  $C_3$  of order 3.
  - b. Use Theorem 5 to find finitely many homogeneous invariants which generate  $k[x, y]^{C_3}$ .
  - c. Can you find fewer invariants that generate  $k[x, y]^{C_3}$ ? Hint: If you have invariants  $f_1, \dots, f_m$ , you can use Proposition 7 to determine whether  $f_1 \in k[f_2, \dots, f_m]$ .
8. Let  $A$  be the matrix of Exercise 7.
- a. Show that  $-A$  generates a cyclic matrix group  $C_6$ , of order 6.
  - b. Show that  $-I_2 \in C_6$ . Then use Exercise 6 and §2 to show that  $k[x, y]^{C_6} \subset k[x^2, y^2, xy]$ . Conclude that all nonzero homogeneous invariants of  $C_6$  have even total degree.
  - c. Use part (b) and Theorem 5 to find  $k[x, y]^{C_6}$ . Hint: There are still a lot of Reynolds operators to compute. You should use a computer algebra program to design a procedure that has  $i, j$  as input and  $R_{C_6}(x^i y^j)$  as output.
9. Let  $A$  be the matrix

$$A = \frac{1}{\sqrt{2}} \begin{pmatrix} 1 & -1 \\ 1 & 1 \end{pmatrix} \in \text{GL}(2, k).$$

- a. Show that  $A$  generates a cyclic matrix group  $C_8 \subset \text{GL}(2, k)$ .
  - b. Give a geometric argument to explain why  $x^2 + y^2 \in k[x, y]^{C_8}$ . Hint:  $A$  is a rotation matrix.
  - c. As in Exercise 8, explain why all homogeneous invariants of  $C_8$  have even total degree.
  - d. Find  $k[x, y]^{C_8}$ . Hint: Do not do this problem unless you know how to design a procedure (on some computer algebra program) that has  $i, j$  as input and  $R_{C_8}(x^i y^j)$  as output.
10. Consider the finite matrix group

$$G = \left\{ \begin{pmatrix} \pm 1 & 0 & 0 \\ 0 & \pm 1 & 0 \\ 0 & 0 & \pm 1 \end{pmatrix} \right\} \subset \text{GL}(3, k).$$

Note that  $G$  has order 8.

- a. If we were to use Theorem 5 to determine  $k[x, y, z]^G$ , for how many monomials would we have to compute the Reynolds operator?
  - b. Use the method of Example 12 in §2 to determine  $k[x, y, z]^G$ .
11. Let  $f$  be the polynomial (4) in the text.
- a. Verify that  $f \in k[x, y]^{C_4} = k[x^2 + y^2, x^3 y - x y^3, x^2 y^2]$ .
  - b. Use Proposition 7 to express  $f$  as a polynomial in  $x^2 + y^2, x^2 y - x y^3, x^2 y^2$ .
12. In Exercises 5, 6, and 7 of §2, we studied the rotation group  $G \subset \text{GL}(3, \mathbb{R})$  of the cube in  $\mathbb{R}^3$  and we found that  $k[x, y, z]^G$  contained the polynomials

$$\begin{aligned} f_1 &= x^2 + y^2 + z^2, \\ f_2 &= (x + y + z)(x + y - z)(x - y + z)(x - y - z), \\ f_3 &= x^2 y^2 z^2, \\ f_4 &= xyz(x^2 - y^2)(x^2 - z^2)(y^2 - z^2). \end{aligned}$$

- a. Give an elementary argument using degrees to show that  $f_4 \notin k[f_1, f_2, f_3]$ .
- b. Use Proposition 7 to show that  $f_3 \notin k[f_1, f_2]$ .
- c. In Exercise 6 of §2, we showed that

$$\left( (x^2 - y^2)(x^2 - z^2)(y^2 - z^2) \right)^2 \in k[x, y, z]^G.$$

Prove that this polynomial lies in  $k[f_1, f_2, f_3]$ . Why can we ignore  $f_4$ ? Using Molien's Theorem and the methods of STURMFELS (1993), one can prove that  $k[x, y, z]^G = k[f_1, f_2, f_3, f_4]$ .

## §4 Relations Among Generators and the Geometry of Orbits

Given a finite matrix group  $G \subset GL(n, k)$ , Theorem 5 of §3 guarantees that there are finitely many homogeneous invariants  $f_1, \dots, f_m$  such that

$$k[x_1, \dots, x_n]^G = k[f_1, \dots, f_m].$$

In this section, we will learn how to describe the *algebraic relations* among  $f_1, \dots, f_m$ , and we will see that these relations have some fascinating algebraic and geometric implications.

We begin by recalling the *uniqueness problem* stated at the end of §2. For a symmetric polynomial  $f \in k[x_1, \dots, x_n]^{S_n} = k[\sigma_1, \dots, \sigma_n]$ , we proved that  $f$  could be written uniquely as a polynomial in  $\sigma_1, \dots, \sigma_n$ . For a general finite matrix group  $G \subset GL(n, k)$ , if we know that  $k[x_1, \dots, x_n]^G = k[f_1, \dots, f_m]$ , then one could similarly ask if  $f \in k[x_1, \dots, x_n]^G$  can be uniquely written in terms of  $f_1, \dots, f_m$ .

To study this question, note that if  $g_1$  and  $g_2$  are polynomials in  $k[y_1, \dots, y_m]$ , then

$$g_1(f_1, \dots, f_m) = g_2(f_1, \dots, f_m) \iff h(f_1, \dots, f_m) = 0,$$

where  $h = g_1 - g_2$ . It follows that uniqueness fails if and only if there is a nonzero polynomial  $h \in k[y_1, \dots, y_m]$  such that  $h(f_1, \dots, f_m) = 0$ . Such a polynomial is a *nontrivial algebraic relation* among  $f_1, \dots, f_m$ .

If we let  $F = (f_1, \dots, f_m)$ , then the set

$$(1) \quad I_F = \{h \in k[y_1, \dots, y_m] : h(f_1, \dots, f_m) = 0 \text{ in } k[x_1, \dots, x_n]\}$$

records *all* algebraic relations among  $f_1, \dots, f_m$ . This set has the following properties.

**Proposition 1.** *If  $k[x_1, \dots, x_n]^G = k[f_1, \dots, f_m]$ , let  $I_F \subset k[y_1, \dots, y_m]$  be as in (1). Then:*

- (i)  $I_F$  is a prime ideal of  $k[y_1, \dots, y_m]$ .
- (ii) Suppose that  $f \in k[x_1, \dots, x_n]^G$  and that  $f = g(f_1, \dots, f_m)$  is one representation of  $f$  in terms of  $f_1, \dots, f_m$ . Then all such representations are given by

$$f = g(f_1, \dots, f_m) + h(f_1, \dots, f_m),$$

as  $h$  varies over  $I_F$ .

**Proof.** For (i), it is an easy exercise to prove that  $I_F$  is an ideal. To show that it is prime, we need to show that  $fg \in I_F$  implies that  $f \in I_F$  or  $g \in I_F$  (see Definition 2

of Chapter 4, §5). But  $fg \in I_F$  means that  $f(f_1, \dots, f_m)g(f_1, \dots, f_m) = 0$ . This is a product of polynomials in  $k[x_1, \dots, x_n]$ , and hence,  $f(f_1, \dots, f_m)$  or  $g(f_1, \dots, f_m)$  must be zero. Thus  $f$  or  $g$  is in  $I_F$ .

We leave the proof of (ii) as an exercise.  $\square$

We will call  $I_F$  the *ideal of relations* for  $F = (f_1, \dots, f_m)$ . Another name for  $I_F$  used in the literature is the *syzygy ideal*. To see what Proposition 1 tells us about the uniqueness problem, consider  $C_2 = \{\pm I_2\} \subset \text{GL}(2, k)$ . We know from §2 that  $k[x, y]^{C_2} = k[x^2, y^2, xy]$ , and, in Example 4, we will see that  $I_F = \langle uv - w^2 \rangle \subset k[u, v, w]$ . Now consider  $x^6 + x^3y^3 \in k[x, y]^{C_2}$ . Then Proposition 1 implies that *all* possible ways of writing  $x^6 + x^3y^3$  in terms of  $x^2, y^2, xy$  are given by

$$(x^2)^3 + (xy)^3 + (x^2 \cdot y^2 - (xy)^2) \cdot b(x^2, y^2, xy)$$

since elements of  $\langle uv - w^2 \rangle$  are of the form  $(uv - w^2) \cdot b(u, v, w)$ .

As an example of what the ideal of relations  $I_F$  can tell us, let us show how it can be used to reconstruct the ring of invariants.

**Proposition 2.** *If  $k[x_1, \dots, x_n]^G = k[f_1, \dots, f_m]$ , let  $I_F \subset k[y_1, \dots, y_m]$  be the ideal of relations. Then there is a ring isomorphism*

$$k[y_1, \dots, y_m]/I_F \cong k[x_1, \dots, x_n]^G$$

*between the quotient ring of  $I_F$  (as defined in Chapter 5, §2) and the ring of invariants.*

**Proof.** Recall from §2 of Chapter 5 that elements of the quotient ring  $k[y_1, \dots, y_m]/I_F$  are written  $[g]$  for  $g \in k[y_1, \dots, y_m]$ , where  $[g_1] = [g_2]$  if and only if  $g_1 - g_2 \in I_F$ .

Now define  $\phi : k[y_1, \dots, y_m]/I_F \rightarrow k[x_1, \dots, x_n]^G$  by

$$\phi([g]) = g(f_1, \dots, f_m).$$

We leave it as an exercise to check that  $\phi$  is well-defined and is a ring homomorphism. We need to show that  $\phi$  is one-to-one and onto.

Since  $k[x_1, \dots, x_n]^G = k[f_1, \dots, f_m]$ , it follows immediately that  $\phi$  is onto. To prove that  $\phi$  is one-to-one, suppose that  $\phi([g_1]) = \phi([g_2])$ . Then  $g_1(f_1, \dots, f_m) = g_2(f_1, \dots, f_m)$ , which implies that  $g_1 - g_2 \in I_F$ . Thus,  $[g_1] = [g_2]$ , and hence,  $\phi$  is one-to-one.

It is a general fact that if a ring homomorphism is one-to-one and onto, then its inverse function is a ring homomorphism. This proves that  $\phi$  is a ring isomorphism.  $\square$

A more succinct proof of this proposition can be given using the Isomorphism Theorem of Exercise 16 in Chapter 5, §2.

For our purposes, another extremely important property of  $I_F$  is that we can compute it explicitly using elimination theory. Namely, consider the system of equations

$$\begin{aligned} y_1 &= f_1(x_1, \dots, x_n), \\ &\vdots \\ y_m &= f_m(x_1, \dots, x_n). \end{aligned}$$

Then  $I_F$  can be obtained by eliminating  $x_1, \dots, x_n$  from these equations.

**Proposition 3.** *If  $k[x_1, \dots, x_n]^G = k[f_1, \dots, f_m]$ , consider the ideal*

$$J_F = \langle f_1 - y_1, \dots, f_m - y_m \rangle \subset k[x_1, \dots, x_n, y_1, \dots, y_m].$$

- (i)  $I_F$  is the  $n$ -th elimination ideal of  $J_F$ . Thus,  $I_F = J_F \cap k[y_1, \dots, y_m]$ .
- (ii) Fix a monomial order in  $k[x_1, \dots, x_n, y_1, \dots, y_m]$  where any monomial involving one of  $x_1, \dots, x_n$  is greater than all monomials in  $k[y_1, \dots, y_m]$  and let  $G$  be a Groebner basis of  $J_F$ . Then  $G \cap k[y_1, \dots, y_m]$  is a Groebner basis for  $I_F$  in the monomial order induced on  $k[y_1, \dots, y_m]$ .

**Proof.** Note that the ideal  $J_F$  appeared earlier in Proposition 7 of §3. To relate  $J_F$  to the ideal of relations  $I_F$ , we will need the following characterization of  $J_F$ : if  $p \in k[x_1, \dots, x_n, y_1, \dots, y_m]$ , then we claim that

$$(2) \quad p \in J_F \iff p(x_1, \dots, x_n, f_1, \dots, f_m) = 0 \text{ in } k[x_1, \dots, x_n].$$

One implication is obvious since the substitution  $y_i \mapsto f_i$  takes all elements of  $J_F = \langle f_1 - y_1, \dots, f_m - y_m \rangle$  to zero. On the other hand, given  $p \in k[x_1, \dots, x_n, y_1, \dots, y_m]$ , if we replace each  $y_i$  in  $p$  by  $f_i - (f_i - y_i)$  and expand, we obtain

$$\begin{aligned} p(x_1, \dots, x_n, y_1, \dots, y_m) &= p(x_1, \dots, x_n, f_1, \dots, f_m) \\ &\quad + B_1 \cdot (f_1 - y_1) + \dots + B_m \cdot (f_m - y_m) \end{aligned}$$

for some  $B_1, \dots, B_m \in k[x_1, \dots, x_n, y_1, \dots, y_m]$  (see Exercise 4 for the details). In particular, if  $p(x_1, \dots, x_n, f_1, \dots, f_m) = 0$ , then

$$p(x_1, \dots, x_n, y_1, \dots, y_m) = B_1 \cdot (f_1 - y_1) + \dots + B_m \cdot (f_m - y_m) \in J_F.$$

This completes the proof of (2).

Now intersect each side of (2) with  $k[y_1, \dots, y_m]$ . For  $p \in k[y_1, \dots, y_m]$ , this proves

$$p \in J_F \cap k[y_1, \dots, y_m] \iff p(f_1, \dots, f_m) = 0 \text{ in } k[x_1, \dots, x_n],$$

so that  $J_F \cap k[y_1, \dots, y_m] = I_F$  by the definition of  $I_F$ . Thus, (i) is proved and (ii) is then an immediate consequence of the elimination theory of Chapter 3 (see Theorem 2 and Exercise 5 of Chapter 3, §1). □

We can use this proposition to compute the relations between generators.

**Example 4.** In §2 we saw that the invariants of  $C_2 = \{\pm I_2\} \subset \text{GL}(2, k)$  are given by  $k[x, y]^{C_2} = k[x^2, y^2, xy]$ . Let  $F = (x^2, y^2, xy)$  and let the new variables be  $u, v, w$ . Then the ideal of relations is obtained by eliminating  $x, y$  from the equations

$$\begin{aligned}u &= x^2, \\v &= y^2, \\w &= xy.\end{aligned}$$

If we use lex order with  $x > y > u > v > w$ , then a Groebner basis for the ideal  $J_F = \langle u - x^2, v - y^2, w - xy \rangle$  consists of the polynomials

$$x^2 - u, xy - w, xv - yw, xw - yu, y^2 - v, uv - w^2.$$

It follows from Proposition 3 that

$$I_F = \langle uv - w^2 \rangle.$$

This says that all relations between  $x^2, y^2$ , and  $xy$  are generated by the obvious relation  $x^2 \cdot y^2 = (xy)^2$ . Then Proposition 2 shows that the ring of invariants can be written as

$$k[x, y]^{C_2} \cong k[u, v, w] / \langle uv - w^2 \rangle.$$

**Example 5.** In §3, we studied the cyclic matrix group  $C_4 \subset \text{GL}(2, k)$  generated by

$$A = \begin{pmatrix} 0 & -1 \\ 1 & 0 \end{pmatrix}$$

and we saw that

$$k[x, y]^{C_4} = k[x^2 + y^2, x^3y - xy^3, x^2y^2].$$

Putting  $F = (x^2 + y^2, x^3y - xy^3, x^2y^2)$ , we leave it as an exercise to show that  $I_F \subset k[u, v, w]$  is given by  $I_F = \langle u^2w - v^2 - 4w^2 \rangle$ . So the one nontrivial relation between the invariants is

$$(x^2 + y^2)^2 \cdot x^2y^2 = (x^3y - xy^3)^2 + 4(x^2y^2)^2.$$

By Proposition 2, we conclude that the ring of invariants can be written as

$$k[x, y]^{C_4} \cong k[u, v, w] / \langle u^2w - v^2 - 4w^2 \rangle.$$

By combining Propositions 1, 2, and 3 with the theory developed in §3 of Chapter 5, we can solve the *uniqueness problem* stated at the end of §2. Suppose that  $k[x_1, \dots, x_n]^G = k[f_1, \dots, f_m]$  and let  $I_F \subset k[y_1, \dots, y_m]$  be the ideal of relations. If  $I_F \neq \{0\}$ , we know that a given element  $f \in k[x_1, \dots, x_n]^G$  can be written in more than one way in terms of  $f_1, \dots, f_m$ . Is there a consistent choice for how to write  $f$ ?

To solve this problem, pick a monomial order on  $k[y_1, \dots, y_m]$  and use Proposition 3 to find a Groebner basis  $G$  of  $I_F$ . Given  $g \in k[y_1, \dots, y_m]$ , let  $\bar{g}^G$  be the remainder of  $g$  on division by  $G$ . In Chapter 5, we showed that the remainders  $\bar{g}^G$  uniquely represent

elements of the quotient ring  $k[y_1, \dots, y_m]/I_F$  (see Proposition 1 of Chapter 5, §3). Using this together with the isomorphism

$$k[y_1, \dots, y_m]/I_F \cong k[x_1, \dots, x_n]^G$$

of Proposition 2, we get a consistent method for writing elements of  $k[x_1, \dots, x_n]^G$  in terms of  $f_1, \dots, f_m$ . Thus, Groebner basis methods help restore the uniqueness lost when  $I_F \neq \{0\}$ .

So far in this section, we have explored the algebra associated with the ideal of relations  $I_F$ . It is now time to turn to the geometry. The basic geometric object associated with an ideal is its variety. Hence, we get the following definition.

**Definition 6.** *If  $k[x_1, \dots, x_n]^G = k[f_1, \dots, f_m]$ , let  $I_F \subset k[y_1, \dots, y_m]$  be the ideal of relations for  $F = (f_1, \dots, f_m)$ . Then we have the affine variety*

$$V_F = \mathbf{V}(I_F) \subset k^m.$$

The variety  $V_F$  has the following properties.

**Proposition 7.** *Let  $I_F$  and  $V_F$  be as in Definition 6.*

(i)  *$V_F$  is the smallest variety in  $k^m$  containing the parametrization*

$$\begin{aligned} y_1 &= f_1(x_1, \dots, x_n), \\ &\vdots \\ y_m &= f_m(x_1, \dots, x_n). \end{aligned}$$

(ii)  *$I_F = \mathbf{I}(V_F)$ , so that  $I_F$  is the ideal of all polynomial functions vanishing on  $V_F$ .*

(iii)  *$V_F$  is an irreducible variety.*

(iv) *Let  $k[V_F]$  be the coordinate ring of  $V_F$  as defined in §4 of Chapter 5. Then there is a ring isomorphism*

$$k[V_F] \cong k[x_1, \dots, x_n]^G.$$

**Proof.** Let  $J_F = \langle f_1 - y_1, \dots, f_m - y_m \rangle$ . By Proposition 3,  $I_F$  is the  $n$ -th elimination ideal of  $J_F$ . Then part (i) follows immediately from the Polynomial Implicitization Theorem of Chapter 3 (see Theorem 1 of Chapter 3, §3).

Turning to (ii), note that we always have  $I_F \subset \mathbf{I}(\mathbf{V}(I_F)) = \mathbf{I}(V_F)$ . To prove the opposite inclusion, suppose that  $h \in \mathbf{I}(V_F)$ . Given any point  $(a_1, \dots, a_n) \in k^n$ , part (i) implies that

$$(f_1(a_1, \dots, a_n), \dots, f_m(a_1, \dots, a_n)) \in V_F.$$

Since  $h$  vanishes on  $V_F$ , it follows that

$$h(f_1(a_1, \dots, a_n), \dots, f_m(a_1, \dots, a_n)) = 0$$

for all  $(a_1, \dots, a_n) \in k^n$ . By assumption,  $k$  has characteristic zero and, hence, is infinite. Then Proposition 5 of Chapter 1, §1 implies that  $h(f_1, \dots, f_m) = 0$  and, hence,  $h \in I_F$ .

By (ii) and Proposition 1,  $\mathbf{I}(V_F) = I_F$  is a prime ideal, so that  $V_F$  is irreducible by Proposition 4 of Chapter 5, §1. (We can also use the parametrization and Proposition 5 of Chapter 4, §5 to give a second proof that  $V_F$  is irreducible.)

Finally, in Chapter 5, we saw that the coordinate ring  $k[V_F]$  could be written as

$$k[V_F] \cong k[y_1, \dots, y_m]/\mathbf{I}(V_F)$$

(see Theorem 7 of Chapter 5, §2). Since  $\mathbf{I}(V_F) = I_F$  by part (ii), we can use the isomorphism of Proposition 2 to obtain

$$(3) \quad k[V_F] \cong k[y_1, \dots, y_m]/I_F \cong k[x_1, \dots, x_n]^G.$$

This completes the proof of the proposition. □

Note how the isomorphisms in (3) link together the three methods (coordinate rings, quotient rings and rings of invariants) that we have learned for creating new rings.

When we write  $k[x_1, \dots, x_n]^G = k[f_1, \dots, f_m]$ , note that  $f_1, \dots, f_m$  are not uniquely determined. So one might ask how changing to a different set of generators affects the variety  $V_F$ . The answer is as follows.

**Corollary 8.** *Suppose that  $k[x_1, \dots, x_n]^G = k[f_1, \dots, f_m] = k[f'_1, \dots, f'_m]$ . If we set  $F = (f_1, \dots, f_m)$  and  $F' = (f'_1, \dots, f'_m)$ , then the varieties  $V_F \subset k^m$  and  $V_{F'} \subset k^{m'}$  are isomorphic (as defined in Chapter 5, §4).*

**Proof.** Applying Proposition 7 twice, we then have isomorphisms  $k[V_F] \cong k[x_1, \dots, x_n]^G \cong k[V_{F'}]$ , and it is easy to see that these isomorphisms are the identity on constants. But in Theorem 9 of Chapter 5, §4, we learned that two varieties are isomorphic if and only if there is an isomorphism of their coordinate rings which is the identity on constants. The corollary follows immediately. □

One of the lessons we learned in Chapter 4 was that the algebra–geometry correspondence works best over an algebraically closed field  $k$ . So for the rest of this section we will assume that  $k$  is algebraically closed.

To uncover the geometry of  $V_F$ , we need to think about the matrix group  $G \subset \text{GL}(n, k)$  more geometrically. So far, we have used  $G$  to act on polynomials: if  $f(\mathbf{x}) \in k[x_1, \dots, x_n]$ , then a matrix  $A \in G$  gives us the new polynomial  $g(\mathbf{x}) = f(A \cdot \mathbf{x})$ . But we can also let  $G$  act on the underlying affine space  $k^n$ . We will write a point  $(a_1, \dots, a_n) \in k^n$  as a column vector  $\mathbf{a}$ . Thus,

$$\mathbf{a} = \begin{pmatrix} a_1 \\ \vdots \\ a_n \end{pmatrix}.$$

Then a matrix  $A \in G$  gives us the new point  $A \cdot \mathbf{a}$  by matrix multiplication.

We can then use  $G$  to describe an equivalence relation on  $k^n$ : given  $\mathbf{a}, \mathbf{b} \in k^n$ , we say that  $\mathbf{a} \sim_G \mathbf{b}$  if  $\mathbf{b} = A \cdot \mathbf{a}$  for some  $A \in G$ . We leave it as an exercise to verify that  $\sim_G$  is indeed an equivalence relation. It is also straightforward to check that the equivalence class of  $\mathbf{a} \in k^n$  is given by

$$\{\mathbf{b} \in k^n : \mathbf{b} \sim_G \mathbf{a}\} = \{A \cdot \mathbf{a} : A \in G\}.$$

These equivalence classes have a special name.

**Definition 9.** Given a finite matrix group  $G \subset \text{GL}(n, k)$  and  $\mathbf{a} \in k^n$ , the  $G$ -orbit of  $\mathbf{a}$  is the set

$$G \cdot \mathbf{a} = \{A \cdot \mathbf{a} : A \in G\}.$$

The set of all  $G$ -orbits in  $k^n$  is denoted  $k^n/G$  and is called the **orbit space**.

Note that an orbit  $G \cdot \mathbf{a}$  has at most  $|G|$  elements. In the exercises, you will show that the number of elements in an orbit is always a divisor of  $|G|$ .

Since orbits are equivalence classes, it follows that the orbit space  $k^n/G$  is the set of equivalence classes of  $\sim_G$ . Thus, we have constructed  $k^n/G$  as a set. But for us, the objects of greatest interest are affine varieties. So it is natural to ask if  $k^n/G$  has the structure of a variety in some affine space. The answer is as follows.

**Theorem 10.** Let  $G \subset \text{GL}(n, k)$  be a finite matrix group, where  $k$  is algebraically closed. Suppose that  $k[x_1, \dots, x_n]^G = k[f_1, \dots, f_m]$ . Then:

- (i) The polynomial mapping  $F : k^n \rightarrow V_F$  defined by  $F(\mathbf{a}) = (f_1(\mathbf{a}), \dots, f_m(\mathbf{a}))$  is surjective. Geometrically, this means that the parametrization  $y_i = f_i(x_1, \dots, x_n)$  covers all of  $V_F$ .
- (ii) The map sending the  $G$ -orbit  $G \cdot \mathbf{a} \subset k^n$  to the point  $F(\mathbf{a}) \in V_F$  induces a one-to-one correspondence

$$k^n/G \cong V_F.$$

**Proof.** We prove part (i) using elimination theory. Let  $J_F = \langle f_1 - y_1, \dots, f_m - y_m \rangle$  be the ideal defined in Proposition 3. Since  $I_F = J_F \cap k[y_1, \dots, y_m]$  is an elimination ideal of  $J_F$ , it follows that a point  $(b_1, \dots, b_m) \in V_F = \mathbf{V}(I_F)$  is a partial solution of the system of equations

$$\begin{aligned} y_1 &= f_1(x_1, \dots, x_n), \\ &\vdots \\ y_m &= f_m(x_1, \dots, x_n). \end{aligned}$$

If we can prove that  $(b_1, \dots, b_m) \in \mathbf{V}(I_F)$  extends to  $(a_1, \dots, a_n, b_1, \dots, b_m) \in \mathbf{V}(J_F)$ , then  $F(a_1, \dots, a_n) = (b_1, \dots, b_m)$  and the surjectivity of  $F : k^n \rightarrow V_F$  will follow.



We claim that for each  $i$ , there is an element  $p_i \in J_F \cap k[x_i, \dots, x_n, y_1, \dots, y_m]$  such that

$$(4) \quad p_i = x_i^N + \text{terms in which } x_i \text{ has degree } < N,$$

where  $N = |G|$ . For now, we will assume that the claim is true.

Suppose that inductively we have extended  $(b_1, \dots, b_m)$  to a partial solution

$$(a_{i+1}, \dots, a_n, b_1, \dots, b_m) \in \mathbf{V}(J_F \cap k[x_{i+1}, \dots, x_n, y_1, \dots, y_m]).$$

Since  $k$  is algebraically closed, the Extension Theorem of Chapter 3, §1 asserts that we can extend to  $(a_i, a_{i+1}, \dots, a_n, b_1, \dots, b_m)$ , provided the leading coefficient in  $x_i$  of one of the generators of  $J_F \cap k[x_i, \dots, x_n, y_1, \dots, y_m]$  does not vanish at the partial solution. Because of our claim, this ideal contains the above polynomial  $p_i$  and we can assume that  $p_i$  is a generator (just add it to the generating set). By (4), the leading coefficient is 1, which never vanishes, so that the required  $a_i$  exists (see Corollary 4 of Chapter 3, §1).

It remains to prove the existence of  $p_i$ . We will need the following lemma.

**Lemma 11.** *Suppose that  $G \subset \text{GL}(n, k)$  is a finite matrix group and  $f \in k[x_1, \dots, x_n]$ . Let  $N = |G|$ . Then there are invariants  $g_1, \dots, g_N \in k[x_1, \dots, x_n]^G$  such that*

$$f^N + g_1 f^{N-1} + \dots + g_N = 0.$$

**Proof.** Consider the polynomial  $\prod_{A \in G} (X - f(A \cdot \mathbf{x}))$ . If we multiply it out, we get

$$\prod_{A \in G} (X - f(A \cdot \mathbf{x})) = X^N + g_1(\mathbf{x})X^{N-1} + \dots + g_N(\mathbf{x}),$$

where the coefficients  $g_1, \dots, g_N$  are in  $k[x_1, \dots, x_n]$ . We claim that  $g_1, \dots, g_N$  are invariant under  $G$ . To prove this, suppose that  $B \in G$ . In the proof of Proposition 3 of §3, we saw that the  $f(AB \cdot \mathbf{x})$  are just the  $f(A \cdot \mathbf{x})$ , possibly in a different order. Thus

$$\prod_{A \in G} (X - f(AB \cdot \mathbf{x})) = \prod_{A \in G} (X - f(A \cdot \mathbf{x})),$$

and then multiplying out each side implies that

$$X^N + g_1(B \cdot \mathbf{x})X^{N-1} + \dots + g_N(B \cdot \mathbf{x}) = X^N + g_1(\mathbf{x})X^{N-1} + \dots + g_N(\mathbf{x})$$

for each  $B \in G$ . This proves that  $g_1, \dots, g_N \in k[x_1, \dots, x_n]^G$ .

Since one of the factors is  $X - f(I_n \cdot \mathbf{x}) = X - f(\mathbf{x})$ , the polynomial vanishes when  $X = f$ , and the lemma is proved.  $\square$

We can now prove our claim about the polynomial  $p_i$ . If we let  $f = x_i$  in Lemma 11, then we get

$$(5) \quad x_i^N + g_1 x_i^{N-1} + \dots + g_N = 0,$$

where  $N = |G|$  and  $g_1, \dots, g_N \in k[x_1, \dots, x_n]^G$ . Using  $k[x_1, \dots, x_n]^G = k[f_1, \dots, f_m]$ , we can write  $g_j = h_j(f_1, \dots, f_m)$  for  $j = 1, \dots, N$ . Then let

$$p_i(x_i, y_1, \dots, y_m) = x_i^N + h_1(y_1, \dots, y_m)x_i^{N-1} + \dots + h_N(y_1, \dots, y_m)$$

in  $k[x_i, y_1, \dots, y_m]$ . From (5), it follows that  $p(x_i, f_1, \dots, f_m) = 0$  and, hence, by (2), we see that  $p_i \in J_F$ . Then  $p_i \in J_F \cap k[x_i, \dots, x_n, y_1, \dots, y_m]$ , and our claim is proved.

To prove (ii), first note that the map

$$\tilde{F} : k^n/G \rightarrow V_F$$

defined by sending  $G \cdot \mathbf{a}$  to  $F(\mathbf{a}) = (f_1(\mathbf{a}), \dots, f_m(\mathbf{a}))$  is well-defined since each  $f_i$  is invariant and, hence, takes the same value on all points of a  $G$ -orbit  $G \cdot \mathbf{a}$ . Furthermore,  $F$  is onto by part (i) and it follows that  $\tilde{F}$  is also onto.

It remains to show that  $\tilde{F}$  is one-to-one. Suppose that  $G \cdot \mathbf{a}$  and  $G \cdot \mathbf{b}$  are distinct orbits. Since  $\sim_G$  is an equivalence relation, it follows that the orbits are disjoint. We will construct an invariant  $g \in k[x_1, \dots, x_n]^G$  such that  $g(\mathbf{a}) \neq g(\mathbf{b})$ . To do this, note that  $S = G \cdot \mathbf{b} \cup G \cdot \mathbf{a} - \{\mathbf{a}\}$  is a finite set of points in  $k^n$  and, hence, is an affine variety. Since  $\mathbf{a} \notin S$ , there must be some defining equation  $f$  of  $S$  which does not vanish at  $\mathbf{a}$ . Thus, for  $A \in G$ , we have

$$f(A \cdot \mathbf{b}) = 0 \quad \text{and} \quad f(A \cdot \mathbf{a}) = \begin{cases} 0 & \text{if } A \cdot \mathbf{a} \neq \mathbf{a} \\ f(\mathbf{a}) \neq 0 & \text{if } A \cdot \mathbf{a} = \mathbf{a}. \end{cases}$$

Then let  $g = R_G(f)$ . We leave it as an exercise to check that

$$g(\mathbf{b}) = 0 \quad \text{and} \quad g(\mathbf{a}) = \frac{M}{|G|} f(\mathbf{a}) \neq 0,$$

where  $M$  is the number of elements  $A \in G$  such that  $A \cdot \mathbf{a} = \mathbf{a}$ . We have thus found an element  $g \in k[x_1, \dots, x_n]^G$  such that  $g(\mathbf{a}) \neq g(\mathbf{b})$ .

Now write  $g$  as a polynomial  $g = h(f_1, \dots, f_m)$  in our generators. Then  $g(\mathbf{a}) \neq g(\mathbf{b})$  implies that  $f_i(\mathbf{a}) \neq f_i(\mathbf{b})$  for some  $i$ , and it follows that  $\tilde{F}$  takes different values on  $G \cdot \mathbf{a}$  and  $G \cdot \mathbf{b}$ . The theorem is now proved.  $\square$

Theorem 10 shows that there is a bijection between the set  $k^n/G$  and the variety  $V_F$ . This is what we mean by saying that  $k^n/G$  has the structure of an affine variety. Further, whereas  $I_F$  depends on the generators chosen for  $k[x_1, \dots, x_n]^G$ , we noted in Corollary 8 that  $V_F$  is unique up to isomorphism. This implies that the variety structure on  $k^n/G$  is unique up to isomorphism.

One nice consequence of Theorem 10 and Proposition 7 is that the “polynomial functions” on the orbit space  $k^n/G$  are given by

$$k[V_F] \cong k[x_1, \dots, x_n]^G.$$

Note how natural this is: an invariant polynomial takes the same value on all points of the  $G$ -orbit and, hence, defines a function on the orbit space. Thus, it is reasonable to expect that  $k[x_1, \dots, x_n]^G$  should be the “coordinate ring” of whatever variety structure we put on  $k^n/G$ .

Still, the bijection  $k^n/G \cong V_F$  is rather remarkable if we look at it slightly differently. Suppose that we start with the geometric action of  $G$  on  $k^n$  which sends  $\mathbf{a}$  to  $A \cdot \mathbf{a}$  for  $A \in G$ . From this, we construct the orbit space  $k^n/G$  as the set of orbits. To give this set the structure of an affine variety, look at what we had to do:

- we made the action algebraic by letting  $G$  act on polynomials;
- we considered the invariant polynomials and found finitely many generators; and
- we formed the ideal of relations among the generators.

The equations coming from this ideal define the desired variety structure  $V_F$  on  $k^n/G$ .

In general, an important problem in algebraic geometry is to take a set of interesting objects ( $G$ -orbits, lines tangent to a curve, etc.) and give it the structure of an affine (or projective—see Chapter 8) variety. Some simple examples will be given in the exercises.

#### EXERCISES FOR §4

1. Given  $f_1, \dots, f_m \in k[x_1, \dots, x_n]$ , let  $I = \{g \in k[y_1, \dots, y_m] : g(f_1, \dots, f_m) = 0\}$ .
  - a. Prove that  $I$  is an ideal of  $k[y_1, \dots, y_m]$ .
  - b. If  $f \in k[f_1, \dots, f_m]$  and  $f = g(f_1, \dots, f_m)$  is one representation of  $f$  in terms of  $f_1, \dots, f_m$ , prove that all such representations are given by  $f = g(f_1, \dots, f_m) + h(f_1, \dots, f_m)$  as  $h$  varies over  $I$ .
2. Let  $f_1, \dots, f_m \in k[x_1, \dots, x_n]$  and let  $I \subset k[y_1, \dots, y_m]$  be the ideal of relations defined in Exercise 1.

- a. Prove that the map sending a coset  $[g]$  to  $g(f_1, \dots, f_m)$  defines a well-defined ring homomorphism

$$\phi : k[y_1, \dots, y_m]/I \longrightarrow k[f_1, \dots, f_m].$$

- b. Prove that the map  $\phi$  of part (a) is one-to-one and onto. Thus  $\phi$  is a ring isomorphism.
  - c. Use Exercise 13 in Chapter 5, §2 to give an alternate proof that  $k[y_1, \dots, y_m]/I$  and  $k[f_1, \dots, f_m]$  are isomorphic. Hint: Consider the ring homomorphism  $\Phi : k[y_1, \dots, y_m] \rightarrow k[f_1, \dots, f_m]$  which sends  $y_i$  to  $f_i$ .
3. Although Propositions 1 and 2 were stated for  $k[x_1, \dots, x_n]^G$ , we saw in Exercises 1 and 2 that these results held for any subring of  $k[x_1, \dots, x_n]$  of the form  $k[f_1, \dots, f_m]$ . Give a similar generalization of Proposition 3. Does the proof given in the text need any changes?
  4. Given  $p \in k[x_1, \dots, x_n, y_1, \dots, y_m]$ , prove that

$$p(x_1, \dots, x_n, y_1, \dots, y_m) = p(x_1, \dots, x_n, f_1, \dots, f_m) + B_1 \cdot (f_1 - y_1) + \dots + B_m \cdot (f_m - y_m)$$

for some  $B_1, \dots, B_m \in k[x_1, \dots, x_n, y_1, \dots, y_m]$ . Hint: In  $p$ , replace each occurrence of  $y_i$  by  $f_i - (f_i - y_i)$ . The proof is similar to the argument given to prove (4) in §1.

5. Complete Example 5 by showing that  $I_F \subset k[u, v, w]$  is given by  $I_F = \langle u^2w - v^2 - 4w^2 \rangle$  when  $F = (x^2 + y^2, x^3y - xy^3, x^2y^2)$ .
6. In Exercise 7 of §3, you were asked to compute the invariants of a certain cyclic group  $C_3 \subset \text{GL}(2, k)$  of order 3. Take the generators you found for  $k[x, y]^{C_3}$  and find the relations between them.
7. Repeat Exercise 6, this time using the cyclic group  $C_6 \subset \text{GL}(2, k)$  of order 6 from Exercise 8 of §3.

8. In Exercise 12 of §3, we listed four invariants  $f_1, f_2, f_3, f_4$  of the group of rotations of the cube in  $\mathbb{R}^3$ .
  - a. Using  $(f_4/xyz)^2$  and part (c) of Exercise 12 of §3, find an algebraic relation between  $f_1, f_2, f_3, f_4$ .
  - b. Show that there are no nontrivial algebraic relations between  $f_1, f_2, f_3$ .
  - c. Show that the relation you found in part (a) generates the ideal of all relations between  $f_1, f_2, f_3, f_4$ . Hint: If  $p(f_1, f_2, f_3, f_4) = 0$  is a relation, use part (a) to reduce to a relation of the form  $p_1(f_1, f_2, f_3) + p_2(f_1, f_2, f_3)f_4 = 0$ . Then explain how degree arguments imply  $p_1(f_1, f_2, f_3) = 0$ .
9. Given a finite matrix group  $G \subset \text{GL}(n, k)$ , we defined the relation  $\sim_G$  on  $k^n$  by  $\mathbf{a} \sim_G \mathbf{b}$  if  $\mathbf{b} = A \cdot \mathbf{a}$  for some  $A \in G$ .
  - a. Verify that  $\sim_G$  is an equivalence relation.
  - b. Prove that the equivalence class of  $\mathbf{a}$  is the set  $G \cdot \mathbf{a}$  defined in the text.
10. Consider the group of rotations of the cube in  $\mathbb{R}^3$ . We studied this group in Exercise 5 of §2, and we know that it has 24 elements.
  - a. Draw a picture of the cube which shows orbits consisting of 1, 6, 8, 12 and 24 elements.
  - b. Argue geometrically that there is no orbit consisting of four elements.
11. (Requires abstract algebra) Let  $G \subset \text{GL}(n, k)$  be a finite matrix group. In this problem, we will prove that the number of elements in an orbit  $G \cdot \mathbf{a}$  divides  $|G|$ .
  - a. Fix  $\mathbf{a} \in k^n$  and let  $H = \{A \in G : A \cdot \mathbf{a} = \mathbf{a}\}$ . Prove that  $H$  is a subgroup of  $G$ . We call  $H$  the *isotropy subgroup* or *stabilizer* of  $\mathbf{a}$ .
  - b. Given  $A \in G$ , we get the *left coset*  $AH = \{AB : B \in H\}$  of  $H$  in  $G$  and we let  $G/H$  denote the set of all left cosets (note that  $G/H$  will not be a group unless  $H$  is normal). Prove that the map sending  $AH$  to  $A \cdot \mathbf{a}$  induces a bijective map  $G/H \cong G \cdot \mathbf{a}$ . Hint: You will need to prove that the map is well-defined. Recall that two cosets  $AH$  and  $BH$  are equal if and only if  $B^{-1}A \in H$ .
  - c. Use part (b) to prove that the number of elements in  $G \cdot \mathbf{a}$  divides  $|G|$ .
12. As in the proof of Theorem 10, suppose that we have disjoint orbits  $G \cdot \mathbf{a}$  and  $G \cdot \mathbf{b}$ . Set  $S = G \cdot \mathbf{b} \cup G \cdot \mathbf{a} - \{\mathbf{a}\}$ , and pick  $f \in k[x_1, \dots, x_n]$  such that  $f = 0$  on all points of  $S$  but  $f(\mathbf{a}) \neq 0$ . Let  $g = R_G(f)$ , where  $R_G$  is the Reynolds operator of  $G$ .
  - a. Explain why  $g(\mathbf{b}) = 0$ .
  - b. Explain why  $g(\mathbf{a}) = \frac{M}{|G|}f(\mathbf{a}) \neq 0$ , where  $M$  is the number of elements  $A \in G$  such that  $A \cdot \mathbf{a} = \mathbf{a}$ .
13. In this exercise, we will see how Theorem 10 can fail when we work over a field that is not algebraically closed. Consider the group of permutation matrices  $S_2 \subset \text{GL}(2, \mathbb{R})$ .
  - a. We know that  $\mathbb{R}[x, y]^{S_2} = \mathbb{R}[\sigma_1, \sigma_2]$ . Show that  $I_F = \{0\}$  when  $F = (\sigma_1, \sigma_2)$ , so that  $V_F = \mathbb{R}^2$ . Thus, Theorem 10 is concerned with the map  $\tilde{F} : \mathbb{R}^2/S_2 \rightarrow \mathbb{R}^2$  defined by sending  $S_2 \cdot (x, y)$  to  $(y_1, y_2) = (x + y, xy)$ .
  - b. Show that the image of  $\tilde{F}$  is the set  $\{(y_1, y_2) \in \mathbb{R}^2 : y_1^2 \geq 4y_2\} \subset \mathbb{R}^2$ . This is the region lying below the parabola  $y_1^2 = 4y_2$ . Hint: Interpret  $y_1$  and  $y_2$  as coefficients of the quadratic  $X^2 - y_1X + y_2$ . When does the quadratic have real roots?
14. There are many places in mathematics where one takes a set of equivalence classes and puts an algebraic structure on them. Show that the construction of a quotient ring  $k[x_1, \dots, x_n]/I$  is an example. Hint: See §2 of Chapter 5.
15. In this exercise, we will give some examples of how something initially defined as a set can turn out to be a variety in disguise. The key observation is that the set of nonvertical lines in the plane  $k^2$  has a natural geometric structure. Namely, such a line  $L$  has a unique equation of the form  $y = mx + b$ , so that  $L$  can be identified with the point  $(m, b)$  in another

2-dimensional affine space, denoted  $k^{2\vee}$ . (If we use projective space—to be studied in the next chapter—then we can also include vertical lines.)

Now suppose that we have a curve  $C$  in the plane. Then consider all lines which are tangent to  $C$  somewhere on the curve. This gives us a subset  $C^\vee \subset k^{2\vee}$ . Let us compute this subset in some simple cases and show that it is an affine variety.

- a. Suppose our curve  $C$  is the parabola  $y = x^2$ . Given a point  $(x_0, y_0)$  on the parabola, show that the tangent line is given by  $y = 2x_0x - x_0^2$  and conclude that  $C^\vee$  is the parabola  $m^2 + 4b = 0$  in  $k^{2\vee}$ .
- b. Show that  $C^\vee$  is an affine variety when  $C$  is the cubic curve  $y = x^3$ .

In general, more work is needed to study  $C^\vee$ . In particular, the method used in the above examples breaks down when there are vertical tangents or singular points. Nevertheless, one can develop a satisfactory theory of what is called the *dual curve*  $C^\vee$  of a curve  $C \subset k^2$ . One can also define the *dual variety*  $V^\vee$  of a given irreducible variety  $V \subset k^n$ .

# 8

## Projective Algebraic Geometry

So far all of the varieties we have studied have been subsets of affine space  $k^n$ . In this chapter, we will enlarge  $k^n$  by adding certain “points at  $\infty$ ” to create  $n$ -dimensional projective space  $\mathbb{P}^n(k)$ . We will then define projective varieties in  $\mathbb{P}^n(k)$  and study the projective version of the algebra-geometry correspondence. The relation between affine and projective varieties will be considered in §4; in §5, we will study elimination theory from a projective point of view. By working in projective space, we will get a much better understanding of the Extension Theorem in Chapter 3. The chapter will end with a discussion of the geometry of quadric hypersurfaces and an introduction to Bezout’s Theorem.

### §1 The Projective Plane

This section will study the projective plane  $\mathbb{P}^2(\mathbb{R})$  over the real numbers  $\mathbb{R}$ . We will see that, in a certain sense, the plane  $\mathbb{R}^2$  is missing some “points at  $\infty$ ,” and by adding them to  $\mathbb{R}^2$ , we will get the projective plane  $\mathbb{P}^2(\mathbb{R})$ . Then we will introduce *homogeneous coordinates* to give a more systematic treatment of  $\mathbb{P}^2(\mathbb{R})$ .

Our starting point is the observation that two lines in  $\mathbb{R}^2$  intersect in a point, *except* when they are parallel. We can take care of this exception if we view parallel lines as meeting at some sort of point at  $\infty$ . As indicated by the picture at the top of the following page, there should be different points at  $\infty$ , depending on the direction of the lines. To approach this more formally, we introduce an equivalence relation on lines in the plane by setting  $L_1 \sim L_2$  if  $L_1$  and  $L_2$  are parallel. Then an equivalence class  $[L]$  consists of all lines parallel to a given line  $L$ . The above discussion suggests that we should introduce one point at  $\infty$  for each equivalence class  $[L]$ . We make the following provisional definition.

**Definition 1.** *The projective plane over  $\mathbb{R}$ , denoted  $\mathbb{P}^2(\mathbb{R})$ , is the set*

$$\mathbb{P}^2(\mathbb{R}) = \mathbb{R}^2 \cup \{\text{one point at } \infty \text{ for each equivalence class of parallel lines}\}.$$

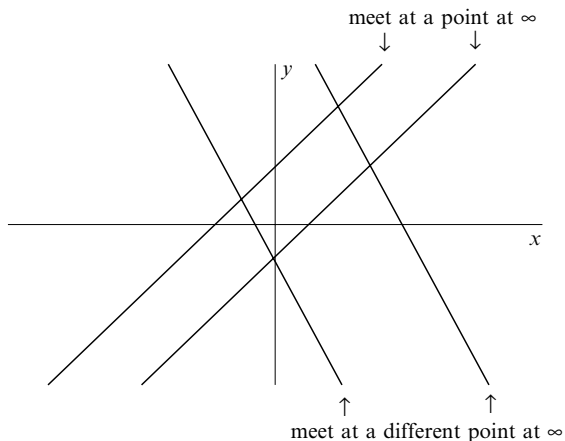

We will let  $[L]_\infty$  denote the common point at  $\infty$  of all lines parallel to  $L$ . Then we call the set  $\bar{L} = L \cup [L]_\infty \subset \mathbb{P}^2(\mathbb{R})$  the *projective line* corresponding to  $L$ . Note that two projective lines always meet at exactly one point: if they are not parallel, they meet at a point in  $\mathbb{R}^2$ ; if they are parallel, they meet at their common point at  $\infty$ .

At first sight, one might expect that a line in the plane should have two points at  $\infty$ , corresponding to the two ways we can travel along the line. However, the reason why we want only one is contained in the previous paragraph: if there were two points at  $\infty$ , then parallel lines would have two points of intersection, not one. So, for example, if we parametrize the line  $x = y$  via  $(x, y) = (t, t)$ , then we can approach its point at  $\infty$  using either  $t \rightarrow \infty$  or  $t \rightarrow -\infty$ .

A common way to visualize points at  $\infty$  is to make a perspective drawing. Pretend that the earth is flat and consider a painting that shows two roads extending infinitely far in different directions:

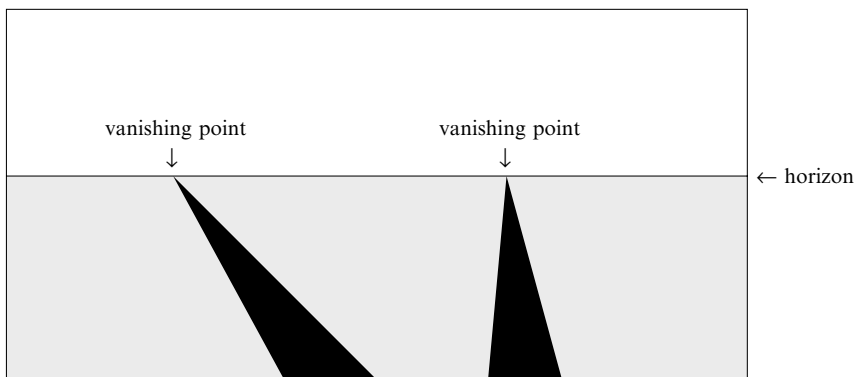

For each road, the two sides (which are parallel, but appear to be converging) meet at the same point on the horizon, which in the theory of perspective is called a *vanishing*

point. Furthermore, any line parallel to one of the roads meets at the same vanishing point, which shows that the vanishing point represents the point at  $\infty$  of these lines. The same reasoning applies to any point on the horizon, so that the horizon in the picture represents points at  $\infty$ . (Note that the horizon does not contain all of them—it is missing the point at  $\infty$  of lines parallel to the horizon.)

The above picture reveals another interesting property of the projective plane: the points at  $\infty$  form a special projective line, which is called the *line at  $\infty$* . It follows that  $\mathbb{P}^2(\mathbb{R})$  has the projective lines  $\bar{L} = L \cup [L]_\infty$ , where  $L$  is a line in  $\mathbb{R}^2$ , together with the line at  $\infty$ . In the exercises, you will prove that two distinct projective lines in  $\mathbb{P}^2(\mathbb{R})$  determine a unique point and two distinct points in  $\mathbb{P}^2(\mathbb{R})$  determine a unique projective line. Note the symmetry in these statements: when we interchange “point” and “projective line” in one, we get the other. This is an instance of the *principle of duality*, which is one of the fundamental concepts of projective geometry.

For an example of how points at  $\infty$  can occur in other contexts, consider the parametrization of the hyperbola  $x^2 - y^2 = 1$  given by the equations

$$x = \frac{1 + t^2}{1 - t^2},$$

$$y = \frac{2t}{1 - t^2}.$$

When  $t \neq \pm 1$ , it is easy to check that this parametrization covers all of the hyperbola except  $(-1, 0)$ . But what happens when  $t = \pm 1$ ? Here is a picture of the hyperbola:

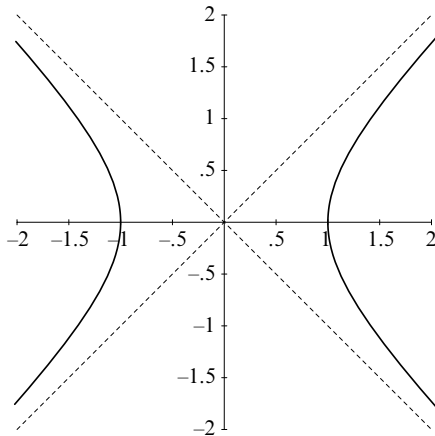

If we let  $t \rightarrow 1^-$ , then the corresponding point  $(x, y)$  travels along the first quadrant portion of the hyperbola, getting closer and closer to the asymptote  $x = y$ . Similarly, if  $t \rightarrow 1^+$ , we approach  $x = y$  along the third quadrant portion of the hyperbola. Hence, it becomes clear that  $t = 1$  should correspond to the point at  $\infty$  of the asymptote  $x = y$ . Similarly, one can check that  $t = -1$  corresponds to the point at  $\infty$  of  $x = -y$ . (In the exercises, we will give a different way to see what happens when  $t = \pm 1$ .)



Thus far, our discussion of the projective plane has introduced some nice ideas, but it is not entirely satisfactory. For example, it is not really clear why the line at  $\infty$  should be called a projective line. A more serious objection is that we have no unified way of naming points in  $\mathbb{P}^2(\mathbb{R})$ . Points in  $\mathbb{R}^2$  are specified by coordinates, but points at  $\infty$  are specified by lines. To avoid this asymmetry, we will introduce *homogeneous coordinates* on  $\mathbb{P}^2(\mathbb{R})$ .

To get homogeneous coordinates, we will need a new definition of projective space. The first step is to define an equivalence relation on nonzero points of  $\mathbb{R}^3$  by setting

$$(x_1, y_1, z_1) \sim (x_2, y_2, z_2)$$

if there is a nonzero real number  $\lambda$  such that  $(x_1, y_1, z_1) = \lambda(x_2, y_2, z_2)$ . One can easily check that  $\sim$  is an equivalence relation on  $\mathbb{R}^3 - \{0\}$  (where as usual  $0$  refers to the origin  $(0, 0, 0)$  in  $\mathbb{R}^3$ ). Then we can redefine projective space as follows.

**Definition 2.**  $\mathbb{P}^2(\mathbb{R})$  is the set of equivalence classes of  $\sim$  on  $\mathbb{R}^3 - \{0\}$ . Thus, we can write

$$\mathbb{P}^2(\mathbb{R}) = (\mathbb{R}^3 - \{0\}) / \sim .$$

If a triple  $(x, y, z) \in \mathbb{R}^3 - \{0\}$  corresponds to a point  $p \in \mathbb{P}^2(\mathbb{R})$ , we say that  $(x, y, z)$  are **homogeneous coordinates** of  $p$ .

At this point, it is not clear that Definitions 1 and 2 give the same object, although we will see shortly that this is the case.

Homogeneous coordinates are different from the usual notion of coordinates in that they are not unique. For example,  $(1, 1, 1)$ ,  $(2, 2, 2)$ ,  $(\pi, \pi, \pi)$  and  $(\sqrt{2}, \sqrt{2}, \sqrt{2})$  are all homogeneous coordinates of the same point in projective space. But the nonuniqueness of the coordinates is not so bad since they are all multiples of one another.

As an illustration of how we can use homogeneous coordinates, let us define the notion of a projective line.

**Definition 3.** Given real numbers  $A, B, C$ , not all zero, the set

$$\{p \in \mathbb{P}^2(\mathbb{R}) : p \text{ has homogeneous coordinates } (x, y, z) \\ \text{with } Ax + By + Cz = 0\}$$

is called a **projective line** of  $\mathbb{P}^2(\mathbb{R})$ .

An important observation is that if  $Ax + By + Cz = 0$  holds for one set  $(x, y, z)$  of homogeneous coordinates of  $p \in \mathbb{P}^2(\mathbb{R})$ , then it holds for *all* homogeneous coordinates of  $p$ . This is because the others can be written  $\lambda(x, y, z) = (\lambda x, \lambda y, \lambda z)$ , so that  $A \cdot \lambda x + B \cdot \lambda y + C \cdot \lambda z = \lambda(Ax + By + Cz) = 0$ . Later in this chapter, we will use the same idea to define varieties in projective space.

To relate our two definitions of projective plane, we will use the map

$$(1) \quad \mathbb{R}^2 \rightarrow \mathbb{P}^2(\mathbb{R})$$

defined by sending  $(x, y) \in \mathbb{R}^2$  to the point  $p \in \mathbb{P}^2(\mathbb{R})$  whose homogeneous coordinates are  $(x, y, 1)$ . This map has the following properties.

**Proposition 4.** *The map (1) is one-to-one and the complement of its image is the projective line  $H_\infty$  defined by  $z = 0$ .*

**Proof.** First, suppose that  $(x, y)$  and  $(x', y')$  map to the same point  $p$  in  $\mathbb{P}^2(\mathbb{R})$ . Then  $(x, y, 1)$  and  $(x', y', 1)$  are homogeneous coordinates of  $p$ , so that  $(x, y, 1) = \lambda(x', y', 1)$  for some  $\lambda$ . Looking at the third coordinate, we see that  $\lambda = 1$  and it follows that  $(x, y) = (x', y')$ .

Next, let  $(x, y, z)$  be homogeneous coordinates of a point  $p \in \mathbb{P}^2(\mathbb{R})$ . If  $z = 0$ , then  $p$  is on the projective line  $H_\infty$ . On the other hand, if  $z \neq 0$ , then we can multiply by  $1/z$  to see that  $(x/z, y/z, 1)$  gives homogeneous coordinates for  $p$ . This shows that  $p$  is in the image of map (1). We leave it as an exercise to show that the image of the map is disjoint from  $H_\infty$ , and the proposition is proved.  $\square$

We will call  $H_\infty$  the *line at  $\infty$* . It is customary (though somewhat sloppy) to identify  $\mathbb{R}^2$  with its image in  $\mathbb{P}^2(\mathbb{R})$ , so that we can write projective space as the disjoint union

$$\mathbb{P}^2(\mathbb{R}) = \mathbb{R}^2 \cup H_\infty.$$

This is beginning to look familiar. It remains to show that  $H_\infty$  consists of points at  $\infty$  in our earlier sense. Thus, we need to study how lines in  $\mathbb{R}^2$  (which we will call *affine lines*) relate to projective lines. The following table tells the story:

affine line	$\rightarrow$	projective line	$\rightarrow$	point at $\infty$
$L : y = mx + b$	$\rightarrow$	$\bar{L} : y = mx + bz$	$\rightarrow$	$(1, m, 0)$
$L : x = c$	$\rightarrow$	$\bar{L} : x = cz$	$\rightarrow$	$(0, 1, 0)$

To understand this table, first consider a nonvertical affine line  $L$  defined by  $y = mx + b$ . Under the map (1), a point  $(x, y)$  on  $L$  maps to a point  $(x, y, 1)$  of the projective line  $\bar{L}$  defined by  $y = mx + bz$ . Thus,  $L$  can be regarded as subset of  $\bar{L}$ . By Proposition 4, the remaining points of  $\bar{L}$  come from where it meets  $z = 0$ . But the equations  $z = 0$  and  $y = mx + bz$  clearly imply  $y = mx$ , so that the solutions are  $(x, mx, 0)$ . We have  $x \neq 0$  since homogeneous coordinates never simultaneously vanish, and dividing by  $x$  shows that  $(1, m, 0)$  is the unique point of  $\bar{L} \cap H_\infty$ . The case of vertical lines is left as an exercise.

The table shows that two lines in  $\mathbb{R}^2$  meet at the same point at  $\infty$  if and only if they are parallel. For nonvertical lines, the point at  $\infty$  encodes the slope, and for vertical lines, there is a single (but different) point at  $\infty$ . Be sure you understand this. In the exercises, you will check that the points listed in the table exhaust all of  $H_\infty$ . Consequently,  $H_\infty$  consists of a unique point at  $\infty$  for every equivalence class of parallel lines. Then  $\mathbb{P}^2(\mathbb{R}) = \mathbb{R}^2 \cup H_\infty$  shows that the projective planes of Definitions 1 and 2 are the same object.

We next introduce a more geometric way of thinking about points in the projective plane. Let  $(x, y, z)$  be homogeneous coordinates of a point  $p$  in  $\mathbb{P}^2(\mathbb{R})$ , so that all other

homogeneous coordinates for  $p$  are given by  $\lambda(x, y, z)$  for  $\lambda \in \mathbb{R} - \{0\}$ . The crucial observation is that these points all lie on the same line through the origin in  $\mathbb{R}^3$ :

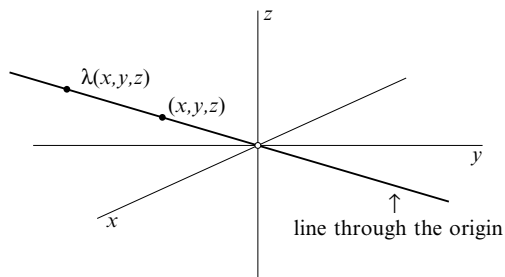

The requirement in Definition 2 that  $(x, y, z) \neq (0, 0, 0)$  guarantees that we get a line in  $\mathbb{R}^3$ . Conversely, given *any* line  $L$  through the origin in  $\mathbb{R}^3$ , a point  $(x, y, z)$  on  $L - \{0\}$  gives homogeneous coordinates for a uniquely determined point in  $\mathbb{P}^2(\mathbb{R})$  [since any other point on  $L - \{0\}$  is a nonzero multiple of  $(x, y, z)$ ]. This shows that we have a one-to-one correspondence.

$$(2) \quad \mathbb{P}^2(\mathbb{R}) \cong \{\text{lines through the origin in } \mathbb{R}^3\}.$$

Although it may seem hard to think of a point in  $\mathbb{P}^2(\mathbb{R})$  as a line in  $\mathbb{R}^3$ , there is a strong intuitive basis for this identification. We can see why by studying how to draw a 3-dimensional object on a 2-dimensional canvas. Imagine lines or rays that link our eye to points on the object. Then we draw according to where the rays intersect the canvas:

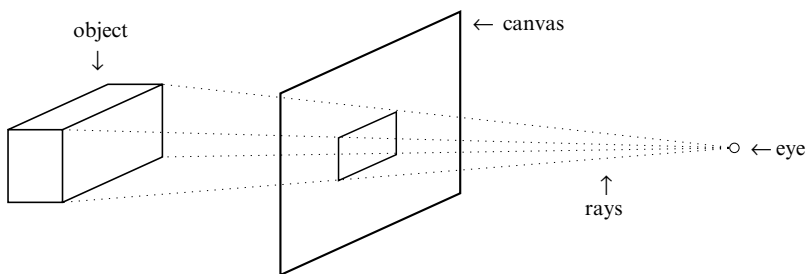

Renaissance texts on perspective would speak of the “pyramid of rays” connecting the artist’s eye with the object being painted. For us, the crucial observation is that each ray hits the canvas exactly once, giving a one-to-one correspondence between rays and points on the canvas.

To make this more mathematical, we will let the “eye” be the origin and the “canvas” be the plane  $z = 1$  in the coordinate system pictured at the top of the next page. Rather than work with rays (which are half-lines), we will work with lines through the origin. Then, as the picture indicates, every point in the plane  $z = 1$  determines a unique line through the origin. This one-to-one correspondence allows us to think of a *point* in the plane as a *line through the origin* in  $\mathbb{R}^3$  [which by (2) is a point in  $\mathbb{P}^2(\mathbb{R})$ ]. There are two interesting things to note about this correspondence:

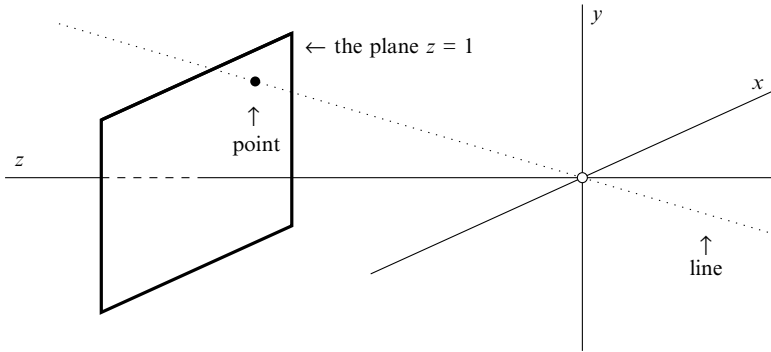

- A point  $(x, y)$  in the plane gives the point  $(x, y, 1)$  on our “canvas”  $z = 1$ . The corresponding line through the origin is a point  $p \in \mathbb{P}^2(\mathbb{R})$  with homogeneous coordinates  $(x, y, 1)$ . Hence, the correspondence given above is *exactly* the map  $\mathbb{R}^2 \rightarrow \mathbb{P}^2(\mathbb{R})$  from Proposition 4.
- The correspondence is not onto since this method will never produce a line in the  $(x, y)$ -plane. Do you see how these lines can be thought of as the points at  $\infty$ ?

In many situations, it is useful to be able to think of  $\mathbb{P}^2(\mathbb{R})$  both algebraically (in terms of homogeneous coordinates) and geometrically (in terms of lines through the origin).

As the final topic in this section, we will use homogeneous coordinates to examine the line at  $\infty$  more closely. The basic observation is that although we began with coordinates  $x$  and  $y$ , once we have homogeneous coordinates, there is nothing special about the extra coordinate  $z$ —it is no different from  $x$  or  $y$ . In particular, if we want, we could regard  $x$  and  $z$  as the original coordinates and  $y$  as the extra one.

To see how this can be useful, consider the parallel lines  $L_1 : y = x + 1/2$  and  $L_2 : y = x - 1/2$  in the  $(x, y)$ -plane:

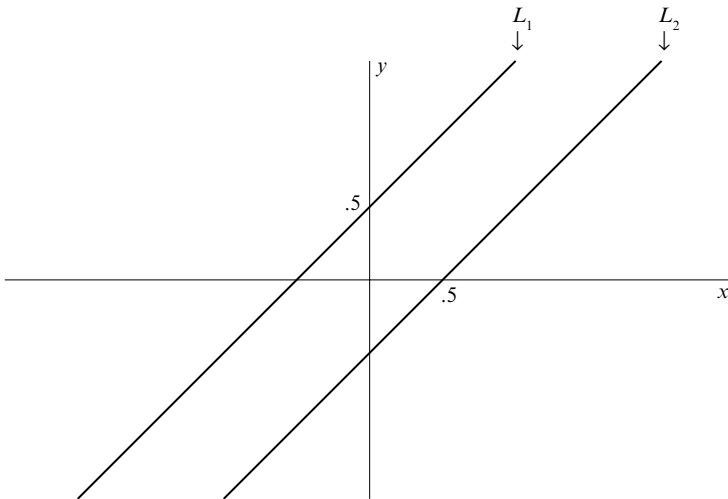

The  $(x, y)$ -Plane

We know that these lines intersect at  $\infty$  since they are parallel. But the picture does not show their point of intersection. To view these lines at  $\infty$ , consider the projective lines

$$\begin{aligned} \overline{L}_1 &: y = x + (1/2)z, \\ \overline{L}_2 &: y = x - (1/2)z \end{aligned}$$

determined by  $L_1$  and  $L_2$ . Now regard  $x$  and  $z$  as the original variables. Thus, we map the  $(x, z)$ -plane  $\mathbb{R}^2$  to  $\mathbb{P}^2(\mathbb{R})$  via  $(x, z) \mapsto (x, 1, z)$ . As in Proposition 4, this map is one-to-one, and we can recover the  $(x, z)$ -plane inside  $\mathbb{P}^2(\mathbb{R})$  by setting  $y = 1$ . If we do this with the equations of the projective lines  $\overline{L}_1$  and  $\overline{L}_2$ , we get the lines  $L'_1 : z = -2x + 2$  and  $L'_2 : z = 2x - 2$ . This gives the following picture in the  $(x, z)$ -plane:

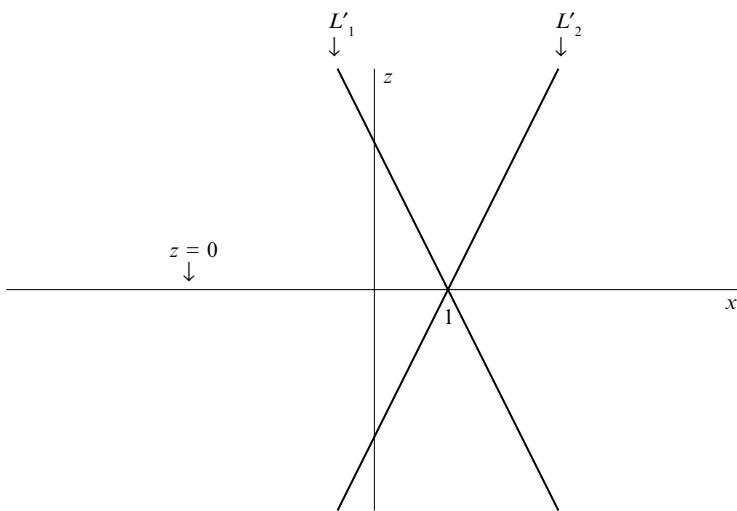

The  $(x, z)$ -Plane

In this picture, the  $x$ -axis is defined by  $z = 0$ , which is the line at  $\infty$  as we originally set things up in Proposition 4. Note that  $L'_1$  and  $L'_2$  meet when  $z = 0$ , which corresponds to the fact that  $L_1$  and  $L_2$  meet at  $\infty$ . Thus, the above picture shows how our two lines behave as they approach the line at  $\infty$ . In the exercises, we will study what some other common curves look like at  $\infty$ .

It is interesting to compare the above picture with the perspective drawing of two roads given earlier in the section. It is no accident that the horizon in the perspective drawing represents the line at  $\infty$ . The exercises will explore this idea in more detail.

Another interesting observation is that the Euclidean notion of distance does not play a prominent role in the geometry of projective space. For example, the lines  $L_1$  and  $L_2$  in the  $(x, y)$ -plane are a constant distance apart, whereas  $L'_1$  and  $L'_2$  get closer and closer in the  $(x, z)$ -plane. This explains why the geometry of  $\mathbb{P}^2(\mathbb{R})$  is quite different from Euclidean geometry.

**EXERCISES FOR §1**

1. Using  $\mathbb{P}^2(\mathbb{R})$  as given in Definition 1, we saw that the projective lines in  $\mathbb{P}^2(\mathbb{R})$  are  $\bar{L} = L \cup [L]_\infty$ , and the line at  $\infty$ .
  - a. Prove that *any* two distinct points in  $\mathbb{P}^2(\mathbb{R})$  determine a unique projective line. Hint: There are three cases to consider, depending on how many of the points are points at  $\infty$ .
  - b. Prove that *any* two distinct projective lines in  $\mathbb{P}^2(\mathbb{R})$  meet at a unique point. Hint: Do this case-by-case.
2. There are many theorems that initially look like theorems in the plane, but which are really theorems in  $\mathbb{P}^2(\mathbb{R})$  in disguise. One classic example is Pappus's Theorem, which goes as follows. Suppose we have two collinear triples of points  $A, B, C$  and  $A', B', C'$ . Then let

$$\begin{aligned}
 P &= \overline{AB'} \cap \overline{A'B}, \\
 Q &= \overline{AC'} \cap \overline{A'C}, \\
 R &= \overline{BC'} \cap \overline{B'C}.
 \end{aligned}$$

Pappus's Theorem states that  $P, Q, R$  are always collinear points. In Exercise 8 of Chapter 6, §4, we drew the following picture to illustrate the theorem:

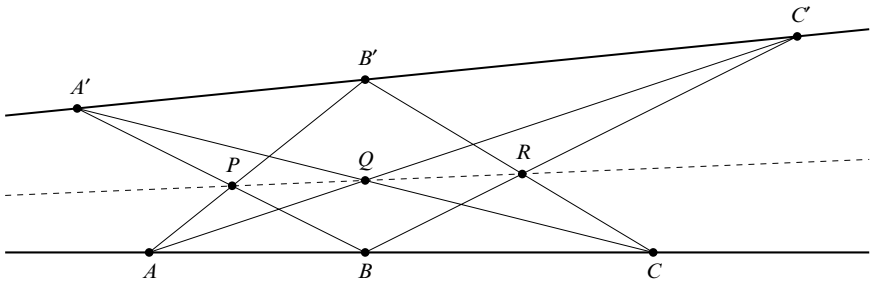

- a. If we let the points on one of the lines go the other way, then we can get the following configuration of points and lines:

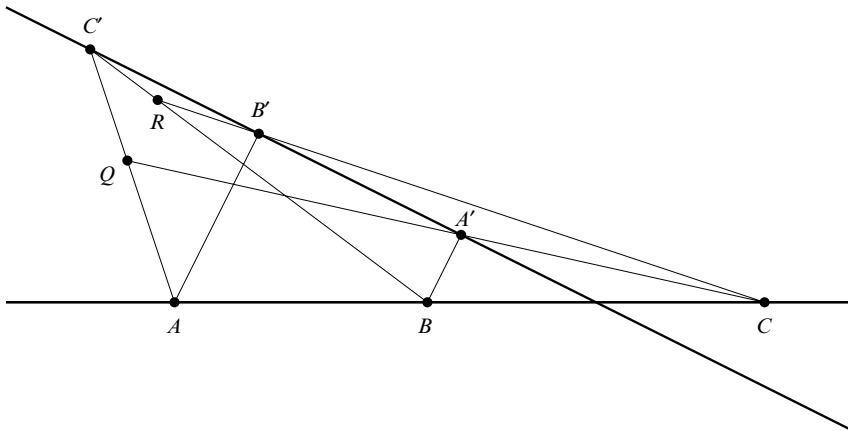

Note that  $P$  is now a point at  $\infty$ . Is Pappus's Theorem still true [in  $\mathbb{P}^2(\mathbb{R})$ ] for the picture on the preceding page?

- b. By moving the point  $C$  in the picture for part (a) show that you can also make  $Q$  a point at  $\infty$ . Is Pappus's Theorem still true? What line do  $P, Q, R$  lie on? Draw a picture to illustrate what happens.

If you made a purely affine version of Pappus's Theorem that took cases (a) and (b) into account, the resulting statement would be rather cumbersome. By working in  $\mathbb{P}^2(\mathbb{R})$ , we cover these cases simultaneously.

3. We will continue the study of the parametrization  $(x, y) = ((1+t^2)/(1-t^2), 2t/(1-t^2))$  of  $x^2 - y^2 = 1$  begun in the text.
- Given  $t$ , show that  $(x, y)$  is the point where the hyperbola intersects the line of slope  $t$  going through the point  $(-1, 0)$ . Illustrate your answer with a picture. Hint: Use the parametrization to show that  $t = y/(x+1)$ .
  - Use the answer to part (a) to explain why  $t = \pm 1$  maps to the points at  $\infty$  corresponding to the asymptotes of the hyperbola. Illustrate your answer with a drawing.
  - Using homogeneous coordinates, show that we can write the parametrization as

$$((1+t^2)/(1-t^2), 2t/(1-t^2), 1) = (1+t^2, 2t, 1-t^2),$$

and use this to explain what happens when  $t = \pm 1$ . Does this give the same answer as part (b)?

- We can also use the technique of part (c) to understand what happens when  $t \rightarrow \infty$ . Namely, in the parametrization  $(x, y, z) = (1+t^2, 2t, 1-t^2)$ , substitute  $t = 1/u$ . Then clear denominators (this is legal since we are using homogeneous coordinates) and let  $u \rightarrow 0$ . What point do you get on the hyperbola?
4. This exercise will study what the hyperbola  $x^2 - y^2 = 1$  looks like at  $\infty$ .
- Explain why the equation  $x^2 - y^2 = z^2$  gives a well-defined curve  $C$  in  $\mathbb{P}^2(\mathbb{R})$ . Hint: See the discussion following Definition 3.
  - What are the points at  $\infty$  on  $C$ ? How does your answer relate to Exercise 3?
  - In the  $(x, z)$  coordinate system obtained by setting  $y = 1$ , show that  $C$  is still a hyperbola.
  - In the  $(y, z)$  coordinate system obtained by setting  $x = 1$ , show that  $C$  is a circle.
  - Use the parametrization of Exercise 3 to obtain a parametrization of the circle from part (d).
5. Consider the parabola  $y = x^2$ .
- What equation should we use to make the parabola into a curve in  $\mathbb{P}^2(\mathbb{R})$ ?
  - How many points at  $\infty$  does the parabola have?
  - By choosing appropriate coordinates (as in Exercise 4), explain why the parabola is tangent to the line at  $\infty$ .
  - Show that the parabola looks like a hyperbola in the  $(y, z)$  coordinate system.
6. When we use the  $(x, y)$  coordinate system inside  $\mathbb{P}^2(\mathbb{R})$ , we only view a piece of the projective plane. In particular, we miss the line at  $\infty$ . As in the text, we can use  $(x, z)$  coordinates to view the line at  $\infty$ . Show that there is exactly one point in  $\mathbb{P}^2(\mathbb{R})$  that is visible in neither  $(x, y)$  nor  $(x, z)$  coordinates. How can we view what is happening at this point?
7. In the proof of Proposition 4, show that the image of the map (2) is disjoint from  $H_\infty$ .
8. As in the text, the line  $H_\infty$  is defined by  $z = 0$ . Thus, points on  $H_\infty$  have homogeneous coordinates  $(a, b, 0)$ , where  $(a, b) \neq (0, 0)$ .
- A vertical affine line  $x = c$  gives the projective line  $x = cz$ . Show that this meets  $H_\infty$  at the point  $(0, 1, 0)$ .

- b. Show that a point on  $H_\infty$  different from  $(0, 1, 0)$  can be written uniquely as  $(1, m, 0)$  for some real number  $m$ .
9. In the text, we viewed parts of  $\mathbb{P}^2(\mathbb{R})$  in the  $(x, y)$  and  $(x, z)$  coordinate systems. In the  $(x, z)$  picture, it is natural to ask what happened to  $y$ . To see this, we will study how  $(x, y)$  coordinates look when viewed in the  $(x, z)$ -plane.
- a. Show that  $(a, b)$  in the  $(x, y)$ -plane gives the point  $(a/b, 1/b)$  in the  $(x, z)$ -plane.
- b. Use the formula of part (a) to study what the parabolas  $(x, y) = (t, t^2)$  and  $(x, y) = (t^2, t)$  look like in the  $(x, z)$ -plane. Draw pictures of what happens in both  $(x, y)$  and  $(x, z)$  coordinates.
10. In this exercise, we will discuss the mathematics behind the perspective drawing given in the text. Suppose we want to draw a picture of a landscape, which we will assume is a horizontal plane. We will make our drawing on a canvas, which will be a vertical plane. Our eye will be a certain distance above the landscape, and to draw, we connect a point on the landscape to our eye with a line, and we put a dot where the line hits the canvas:

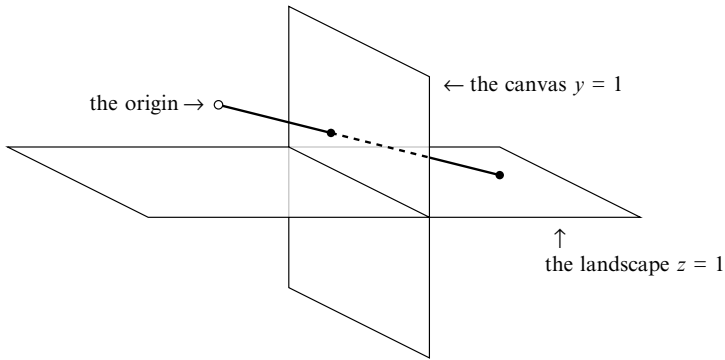

To give formulas for what happens, we will pick coordinates  $(x, y, z)$  so that our eye is the origin, the canvas is the plane  $y = 1$ , and the landscape is the plane  $z = 1$  (thus, the positive  $z$ -axis points down).

- a. Starting with the point  $(a, b, 1)$  on the landscape, what point do we get in the canvas  $y = 1$ ?
- b. Explain how the answer to part (a) relates to Exercise 9. Write a brief paragraph discussing the relation between perspective drawings and the projective plane.
11. As in Definition 3, a projective line in  $\mathbb{P}^2(\mathbb{R})$  is defined by an equation of the form  $Ax + By + Cz = 0$ , where  $(A, B, C) \neq (0, 0, 0)$ .
- a. Why do we need to make the restriction  $(A, B, C) \neq (0, 0, 0)$ ?
- b. Show that  $(A, B, C)$  and  $(A', B', C')$  define the same projective line if and only if  $(A, B, C) = \lambda(A', B', C')$  for some nonzero real number  $\lambda$ . Hint: One direction is easy. For the other direction, take two distinct points  $(a, b, c)$  and  $(a', b', c')$  on the line  $Ax + By + Cz = 0$ . Show that  $(a, b, c)$  and  $(a', b', c')$  are linearly independent and conclude that the equations  $Xa + Yb + Zc = Xa' + Yb' + Zc' = 0$  have a 1-dimensional solution space for the variables  $X, Y, Z$ .
- c. Conclude that the set of projective lines in  $\mathbb{P}^2(\mathbb{R})$  can be identified with the set  $\{(A, B, C) \in \mathbb{R}^3 : (A, B, C) \neq (0, 0, 0)\} / \sim$ . This set is called the *dual projective plane* and is denoted  $\mathbb{P}^2(\mathbb{R})^\vee$ .
- d. Describe the subset of  $\mathbb{P}^2(\mathbb{R})^\vee$  corresponding to affine lines.



e. Given a point  $p \in \mathbb{P}^2(\mathbb{R})$ , consider the set  $\tilde{p}$  of all projective lines  $L$  containing  $p$ . We can regard  $\tilde{p}$  as a subset of  $\mathbb{P}^2(\mathbb{R})^\vee$ . Show that  $\tilde{p}$  is a projective line in  $\mathbb{P}^2(\mathbb{R})^\vee$ . We call  $\tilde{p}$  the *pencil of lines* through  $p$ .

f. The Cartesian product  $\mathbb{P}^2(\mathbb{R}) \times \mathbb{P}^2(\mathbb{R})^\vee$  has the natural subset

$$I = \{(p, L) \in \mathbb{P}^2(\mathbb{R}) \times \mathbb{P}^2(\mathbb{R})^\vee : p \in L\}.$$

Show that  $I$  is described by the equation  $Ax + By + Cz = 0$ , where  $(x, y, z)$  are homogeneous coordinates on  $\mathbb{P}^2(\mathbb{R})$  and  $(A, B, C)$  are homogeneous coordinates on the dual. We will study varieties of this type in §5.

Parts (d), (e), and (f) of this exercise illustrate how collections of naturally defined geometric objects can be given an algebraic structure.

## §2 Projective Space and Projective Varieties

The construction of the real projective plane given in Definition 2 of §1 can be generalized to yield projective spaces of any dimension  $n$  over any field  $k$ . We define an equivalence relation  $\sim$  on the nonzero points of  $k^{n+1}$  by setting

$$(x'_0, \dots, x'_n) \sim (x_0, \dots, x_n)$$

if there is a nonzero element  $\lambda \in k$  such that  $(x'_0, \dots, x'_n) = \lambda(x_0, \dots, x_n)$ . If we let  $0$  denote the origin  $(0, \dots, 0)$  in  $k^{n+1}$ , then we define projective space as follows.

**Definition 1.**  *$n$ -dimensional projective space over the field  $k$ , denoted  $\mathbb{P}^n(k)$ , is the set of equivalence classes of  $\sim$  on  $k^{n+1} - \{0\}$ . Thus,*

$$\mathbb{P}^n(k) = (k^{n+1} - \{0\}) / \sim.$$

Each nonzero  $(n+1)$ -tuple  $(x_0, \dots, x_n) \in k^{n+1}$  defines a point  $p$  in  $\mathbb{P}^n(k)$ , and we say that  $(x_0, \dots, x_n)$  are **homogeneous coordinates** of  $p$ .

Like  $\mathbb{P}^2(\mathbb{R})$ , each point  $p \in \mathbb{P}^n(k)$  has many sets of homogeneous coordinates. For example, in  $\mathbb{P}^3(\mathbb{C})$ , the homogeneous coordinates  $(0, \sqrt{2}, 0, i)$  and  $(0, 2i, 0, -\sqrt{2})$  describe the same point since  $(0, 2i, 0, -\sqrt{2}) = \sqrt{2}i(0, \sqrt{2}, 0, i)$ . In general, we will write  $p = (x_0, \dots, x_n)$  to denote that  $(x_0, \dots, x_n)$  are homogeneous coordinates of  $p \in \mathbb{P}^n(k)$ .

As in §1, we can think of  $\mathbb{P}^n(k)$  more geometrically as the set of lines through the origin in  $k^{n+1}$ . More precisely, you will show in Exercise 1 that there is a one-to-one correspondence

$$(1) \quad \mathbb{P}^n(k) \cong \{\text{lines through the origin in } k^{n+1}\}.$$

Just as the real projective plane contains the affine plane  $\mathbb{R}^2$  as a subset,  $\mathbb{P}^n(k)$  contains the affine space  $k^n$ .

**Proposition 2.** *Let*

$$U_0 = \{(x_0, \dots, x_n) \in \mathbb{P}^n(k) : x_0 \neq 0\}.$$

*Then the map  $\phi$  taking  $(a_1, \dots, a_n)$  in  $k^n$  to the point with homogeneous coordinates  $(1, a_1, \dots, a_n)$  in  $\mathbb{P}^n(k)$  is a one-to-one correspondence between  $k^n$  and  $U_0 \subset \mathbb{P}^n(k)$ .*

**Proof.** Since the first component of  $\phi(a_1, \dots, a_n) = (1, a_1, \dots, a_n)$  is nonzero, we get a map  $\phi : k^n \rightarrow U_0$ . We can also define an inverse map  $\psi : U_0 \rightarrow k^n$  as follows. Given  $p = (x_0, \dots, x_n) \in U_0$  since  $x_0 \neq 0$  we can multiply the homogeneous coordinates by the nonzero scalar  $\lambda = \frac{1}{x_0}$  to obtain  $p = (1, \frac{x_1}{x_0}, \dots, \frac{x_n}{x_0})$ . Then set  $\psi(p) = (\frac{x_1}{x_0}, \dots, \frac{x_n}{x_0}) \in k^n$ . We leave it as an exercise for the reader to show that  $\psi$  is well-defined and that  $\phi$  and  $\psi$  are inverse mappings. This establishes the desired one-to-one correspondence.  $\square$

By the definition of  $U_0$ , we see that  $\mathbb{P}^n(k) = U_0 \cup H$ , where

$$(2) \quad H = \{p \in \mathbb{P}^n(k) : p = (0, x_1, \dots, x_n)\}.$$

If we identify  $U_0$  with the affine space  $k^n$ , then we can think of  $H$  as the *hyperplane at infinity*. It follows from (2) that the points in  $H$  are in one-to-one correspondence with  $n$ -tuples  $(x_1, \dots, x_n)$ , where two  $n$ -tuples represent the same point of  $H$  if one is a nonzero scalar multiple of the other (just ignore the first component of points in  $H$ ). In other words,  $H$  is a “copy” of  $\mathbb{P}^{n-1}(k)$ , the projective space of one smaller dimension. Identifying  $U_0$  with  $k^n$  and  $H$  with  $\mathbb{P}^{n-1}(k)$ , we can write

$$(3) \quad \mathbb{P}^n(k) = k^n \cup \mathbb{P}^{n-1}(k).$$

To see what  $H = \mathbb{P}^{n-1}(k)$  means geometrically, note that, by (1), a point  $p \in \mathbb{P}^{n-1}(k)$  gives a line  $L \subset k^n$  going through the origin. Consequently, in the decomposition (3), we should think of  $p$  as representing the asymptotic direction of *all* lines in  $k^n$  parallel to  $L$ . This allows us to regard  $p$  as a point at  $\infty$  in the sense of §1, and we recover the intuitive definition of the projective space given there. In the exercises, we will give a more algebraic way of seeing how this works.

A special case worth mentioning is the projective line  $\mathbb{P}^1(k)$ . Since  $\mathbb{P}^0(k)$  consists of a single point (this follows easily from Definition 1), letting  $n = 1$  in (3) gives us

$$\mathbb{P}^1(k) = k^1 \cup \mathbb{P}^0(k) = k \cup \{\infty\},$$

where we let  $\infty$  represent the single point of  $\mathbb{P}^0(k)$ . If we use (1) to think of points in  $\mathbb{P}^1(k)$  as lines through the origin in  $k^2$ , then the above decomposition reflects the fact these lines are characterized by their slope (where the vertical line has slope  $\infty$ ). When  $k = \mathbb{C}$ , it is customary to call

$$\mathbb{P}^1(\mathbb{C}) = \mathbb{C} \cup \{\infty\}$$

the *Riemann sphere*. The reason for this name will be explored in the exercises.

For completeness, we mention that there are many other copies of  $k^n$  in  $\mathbb{P}^n(k)$  besides  $U_0$ . Indeed the proof of Proposition 2 may be adapted to yield the following results.

**Corollary 3.** For each  $i = 0, \dots, n$ , let

$$U_i = \{(x_0, \dots, x_n) \in \mathbb{P}^n(k) : x_i \neq 0\}.$$

(i) The points of each  $U_i$  are in one-to-one correspondence with the points of  $k^n$ .

- (ii) *The complement  $\mathbb{P}^n(k) - U_i$  may be identified with  $\mathbb{P}^{n-1}(k)$ .*  
 (iii) *We have  $\mathbb{P}^n(k) = \cup_{i=0}^n U_i$ .*

**Proof.** See Exercise 5. □

Our next goal is to extend the definition of varieties in affine space to projective space. For instance, we can ask whether it makes sense to consider  $\mathbf{V}(f)$  for a polynomial  $f \in k[x_0, \dots, x_n]$ . A simple example shows that some care must be taken here. For instance, in  $\mathbb{P}^2(\mathbb{R})$ , we can try to construct  $\mathbf{V}(x_1 - x_2^2)$ . The point  $p = (x_0, x_1, x_2) = (1, 4, 2)$  appears to be in this set since the components of  $p$  satisfy the equation  $x_1 - x_2^2 = 0$ . However, a problem arises when we note that the same point  $p$  can be represented by the homogeneous coordinates  $p = 2(1, 4, 2) = (2, 8, 4)$ . If we substitute these components into our polynomial, we obtain  $8 - 4^2 = -8 \neq 0$ . We get different results depending on which homogeneous coordinates we choose.

To avoid problems of this type, we use *homogeneous* polynomials when working in  $\mathbb{P}^n(k)$ . From Definition 6 of Chapter 7, §1, recall that a polynomial is *homogeneous* of total degree  $d$  if every term appearing in  $f$  has total degree exactly  $d$ . The polynomial  $f = x_1 - x_2^2$  in the example is not homogeneous, and this is what caused the inconsistency in the values of  $f$  on different homogeneous coordinates representing the same point. For a homogeneous polynomial, this does not happen.

**Proposition 4.** *Let  $f \in k[x_0, \dots, x_n]$  be a homogeneous polynomial. If  $f$  vanishes on any one set of homogeneous coordinates for a point  $p \in \mathbb{P}^n(k)$ , then  $f$  vanishes for all homogeneous coordinates of  $p$ . In particular  $\mathbf{V}(f) = \{p \in \mathbb{P}^n(k) : f(p) = 0\}$  is a well-defined subset of  $\mathbb{P}^n(k)$ .*

**Proof.** Let  $(a_0, \dots, a_n)$  and  $(\lambda a_0, \dots, \lambda a_n)$  be homogeneous coordinates for  $p \in \mathbb{P}^n(k)$  and assume that  $f(a_0, \dots, a_n) = 0$ . If  $f$  is homogeneous of total degree  $k$ , then every term in  $f$  has the form

$$c x_0^{\alpha_0} \cdots x_n^{\alpha_n},$$

where  $\alpha_0 + \cdots + \alpha_n = k$ . When we substitute  $x_i = \lambda a_i$ , this term becomes

$$c(\lambda a_0)^{\alpha_0} \cdots (\lambda a_n)^{\alpha_n} = \lambda^k c a_0^{\alpha_0} \cdots a_n^{\alpha_n}.$$

Summing over the terms in  $f$ , we find a common factor of  $\lambda^k$  and, hence,

$$f(\lambda a_0, \dots, \lambda a_n) = \lambda^k f(a_0, \dots, a_n) = 0.$$

This proves the proposition. □

Notice that even if  $f$  is homogeneous, the equation  $f = a$  does not make sense in  $\mathbb{P}^n(k)$  when  $0 \neq a \in k$ . The equation  $f = 0$  is special because it gives a well-defined subset of  $\mathbb{P}^n(k)$ . We can also consider subsets of  $\mathbb{P}^n(k)$  defined by the vanishing of a

system of homogeneous polynomials (possibly of different total degrees). The correct generalization of the affine varieties introduced in Chapter 1, §2 is as follows.

**Definition 5.** Let  $k$  be a field and let  $f_1, \dots, f_s \in k[x_0, \dots, x_n]$  be homogeneous polynomials. We set

$$\mathbf{V}(f_1, \dots, f_s) = \{(a_0, \dots, a_n) \in \mathbb{P}^n(k) : f_i(a_0, \dots, a_n) = 0 \text{ for all } 1 \leq i \leq s\}.$$

We call  $\mathbf{V}(f_1, \dots, f_s)$  the **projective variety** defined by  $f_1, \dots, f_s$ .

For example, in  $\mathbb{P}^n(k)$ , any nonzero homogeneous polynomial of degree 1,

$$\ell(x_0, \dots, x_n) = c_0x_0 + \dots + c_nx_n,$$

defines a projective variety  $\mathbf{V}(\ell)$  called a *hyperplane*. One example we have seen is the hyperplane at infinity, which was defined as  $H = \mathbf{V}(x_0)$ . When  $n = 2$ , we call  $\mathbf{V}(\ell)$  a projective line, or more simply a *line* in  $\mathbb{P}^2(k)$ . Similarly, when  $n = 3$ , we call a hyperplane a *plane* in  $\mathbb{P}^3(k)$ . Varieties defined by one or more linear polynomials (homogeneous polynomials of degree 1) are called *linear varieties* in  $\mathbb{P}^n(k)$ . For instance,  $\mathbf{V}(x_1, x_2) \subset \mathbb{P}^3(k)$  is a linear variety which is a projective line in  $\mathbb{P}^3(k)$ .

The projective varieties  $\mathbf{V}(f)$  defined by a single nonzero homogeneous equation are known collectively as *hypersurfaces*. However, individual hypersurfaces are usually classified according to the total degree of the defining equation. Thus, if  $f$  has total degree 2 in  $k[x_0, \dots, x_n]$ , we usually call  $\mathbf{V}(f)$  a *quadric hypersurface*, or *quadric* for short. For instance,  $\mathbf{V}(-x_0^2 + x_1^2 + x_2^2) \subset \mathbb{P}^3(\mathbb{R})$  is quadric. Similarly, hypersurfaces defined by equations of total degree 3, 4, and 5 are known as *cubics*, *quartics*, and *quintics*, respectively.

To get a better understanding of projective varieties, we need to discover what the corresponding algebraic objects are. This leads to the notion of *homogeneous ideal*, which will be discussed in §3. We will see that the entire algebra-geometry correspondence of Chapter 4 can be carried over to projective space.

The final topic we will consider in this section is the relation between affine and projective varieties. As we saw in Corollary 3, the subsets  $U_i \subset \mathbb{P}^n(k)$  are copies of  $k^n$ . Thus, we can ask how affine varieties in  $U_i \cong k^n$  relate to projective varieties in  $\mathbb{P}^n(k)$ . First, if we take a projective variety  $V$  and intersect it with one of the  $U_i$ , it makes sense to ask whether we obtain an affine variety. The answer to this question is always *yes*, and the defining equations of the variety  $V \cap U_i$  may be obtained by a process called *dehomogenization*. We illustrate this by considering  $V \cap U_0$ . From the proof of Proposition 2, we know that if  $p \in U_0$ , then  $p$  has homogeneous coordinates of the form  $(1, x_1, \dots, x_n)$ . If  $f \in k[x_0, \dots, x_n]$  is one of the defining equations of  $V$ , then the polynomial  $g(x_1, \dots, x_n) = f(1, x_1, \dots, x_n) \in k[x_1, \dots, x_n]$  vanishes at every point of  $V \cap U_0$ . Setting  $x_0 = 1$  in  $f$  produces a “dehomogenized” polynomial  $g$  which is usually nonhomogeneous. We claim that  $V \cap U_0$  is precisely the affine variety obtained by dehomogenizing the equations of  $V$ .

**Proposition 6.** *Let  $V = \mathbf{V}(f_1, \dots, f_s)$  be a projective variety. Then  $W = V \cap U_0$  can be identified with the affine variety  $\mathbf{V}(g_1, \dots, g_s) \subset k^n$ , where  $g_i(y_1, \dots, y_n) = f_i(1, y_1, \dots, y_n)$  for each  $1 \leq i \leq s$ .*

**Proof.** The comments before the statement of the proposition show that using the mapping  $\psi : U_0 \rightarrow k^n$  from Proposition 2,  $\psi(W) \subset \mathbf{V}(g_1, \dots, g_s)$ . On the other hand, if  $(a_1, \dots, a_n) \in \mathbf{V}(g_1, \dots, g_s)$ , then the point with homogeneous coordinates  $(1, a_1, \dots, a_n)$  is in  $U_0$  and it satisfies the equations

$$f_i(1, a_1, \dots, a_n) = g_i(a_1, \dots, a_n) = 0.$$

Thus,  $\phi(\mathbf{V}(g_1, \dots, g_s)) \subset W$ . Since the mappings  $\phi$  and  $\psi$  are inverses, the points of  $W$  are in one-to-one correspondence with the points of  $\mathbf{V}(g_1, \dots, g_s)$ .  $\square$

For instance, consider the projective variety

$$(4) \quad V = \mathbf{V}(x_1^2 - x_2x_0, x_1^3 - x_3x_0^2) \subset \mathbb{P}^3(\mathbb{R}).$$

To intersect  $V$  with  $U_0$ , we dehomogenize the defining equations, which gives us the affine variety

$$\mathbf{V}(x_1^2 - x_2, x_1^3 - x_3) \subset \mathbb{R}^3.$$

We recognize this as the familiar twisted cubic in  $\mathbb{R}^3$ .

We can also dehomogenize with respect to other variables. For example, the above proof shows that, for any projective variety  $V \subset \mathbb{P}^3(\mathbb{R})$ ,  $V \cap U_1$  can be identified with the affine variety in  $\mathbb{R}^3$  defined by the equations obtained by setting  $g_i(x_0, x_2, x_3) = f_i(x_0, 1, x_2, x_3)$ . When we do this with the projective variety  $V$  defined in (4), we see that  $V \cap U_1$  is the affine variety  $\mathbf{V}(1 - x_2x_0, 1 - x_3x_0^2)$ . See Exercise 9 for a general statement.

Going in the opposite direction, we can ask whether an affine variety in  $U_i$  can be written as  $V \cap U_i$  in some projective variety  $V$ . The answer is again *yes*, but there is more than one way to do it, and the results can be somewhat unexpected.

One natural idea is to reverse the dehomogenization process described earlier and “homogenize” the defining equations of the affine variety. For example, consider the affine variety  $W = \mathbf{V}(x_2 - x_1^3 + x_1^2)$  in  $U_0 = \mathbb{R}^2$ . The defining equation is not homogeneous, so we do not get a projective variety in  $\mathbb{P}^2(\mathbb{R})$  directly from this equation. But we can use the extra variable  $x_0$  to make  $f = x_2 - x_1^3 + x_1^2$  homogeneous. Since  $f$  has total degree 3, we modify  $f$  so that every term has total degree 3. This leads to the homogeneous polynomial

$$f^h = x_2x_0^2 - x_1^3 + x_1^2x_0.$$

Moreover, note that dehomogenizing  $f^h$  gives back the original polynomial  $f$  in  $x_1, x_2$ . The general pattern is the same.

**Proposition 7.** Let  $g(x_1, \dots, x_n) \in k[x_1, \dots, x_n]$  be a polynomial of total degree  $d$ .

- (i) Let  $g = \sum_{i=0}^d g_i$  be the expansion of  $g$  as the sum of its homogeneous components where  $g_i$  has total degree  $i$ . Then

$$\begin{aligned} g^h(x_0, \dots, x_n) &= \sum_{i=0}^d g_i(x_1, \dots, x_n)x_0^{d-i} \\ &= g_d(x_1, \dots, x_n) + g_{d-1}(x_1, \dots, x_n)x_0 \\ &\quad + \cdots + g_0(x_1, \dots, x_n)x_0^d \end{aligned}$$

is a homogeneous polynomial of total degree  $d$  in  $k[x_0, \dots, x_n]$ . We will call  $g^h$  the **homogenization** of  $g$ .

- (ii) The homogenization of  $g$  can be computed using the formula

$$g^h = x_0^d \cdot g\left(\frac{x_1}{x_0}, \dots, \frac{x_n}{x_0}\right).$$

- (iii) Dehomogenizing  $g^h$  yields  $g$ . That is,  $g^h(1, x_1, \dots, x_n) = g(x_1, \dots, x_n)$ .

- (iv) Let  $F(x_0, \dots, x_n)$  be a homogeneous polynomial and let  $x_0^e$  be the highest power of  $x_0$  dividing  $F$ . If  $f = F(1, x_1, \dots, x_n)$  is a dehomogenization of  $F$ , then  $F = x_0^e \cdot f^h$ .

**Proof.** We leave the proof to the reader as Exercise 10. □

As a result of Proposition 7, given any affine variety  $W = \mathbf{V}(g_1, \dots, g_s) \subset k^n$ , we can homogenize the defining equations of  $W$  to obtain a projective variety  $V = \mathbf{V}(g_1^h, \dots, g_s^h) \subset \mathbb{P}^n(k)$ . Moreover, by part (iii) and Proposition 6, we see that  $V \cap U_0 = W$ . Thus, our original affine variety  $W$  is the *affine portion* of the projective variety  $V$ .

As we mentioned before, though, there are some unexpected possibilities.

**Example 8.** In this example, we will write the homogeneous coordinates of points in  $\mathbb{P}^2(k)$  as  $(x, y, z)$ . Numbering them as 0, 1, 2, we see that  $U_2$  is the set of points with homogeneous coordinates  $(x, y, 1)$ , and  $x$  and  $y$  are coordinates on  $U_2 \cong k^2$ . Now consider the affine variety  $W = \mathbf{V}(g) = \mathbf{V}(y - x^3 + x) \subset U_2$ . We know that  $W$  is the affine portion  $V \cap U_2$  of the projective variety  $V = \mathbf{V}(g^h) = \mathbf{V}(yz^2 - x^3 + xz^2)$ .

The variety  $V$  consists of  $W$  together with the points at infinity  $V \cap \mathbf{V}(z)$ . The affine portion  $W$  is the graph of a cubic polynomial, which is a nonsingular plane curve. The points at infinity, which form the complement of  $W$  in  $V$ , are given by the solutions of the equations

$$\begin{aligned} 0 &= yz^2 - x^3 + xz^2, \\ 0 &= z. \end{aligned}$$

It is easy to see that the solutions are  $z = x = 0$  and since we are working in  $\mathbb{P}^2(k)$ , we get the unique point  $p = (0, 1, 0)$  in  $V \cap \mathbf{V}(z)$ . Thus,  $V = W \cup \{p\}$ . An unexpected feature of this example is the nature of the extra point  $p$ .

To see what  $V$  looks like at  $p$ , let us dehomogenize the equation of  $V$  with respect to  $y$  and study the intersection  $V \cap U_1$ . We find

$$W' = V \cap U_1 = \mathbf{V}(g^h(x, 1, z)) = \mathbf{V}(z^2 - x^3 + xz^2).$$

From the discussion of singularities in §4 of Chapter 3, one can easily check that  $p$ , which becomes the point  $(x, z) = (0, 0) \in W'$ , is a singular point on  $W'$ :

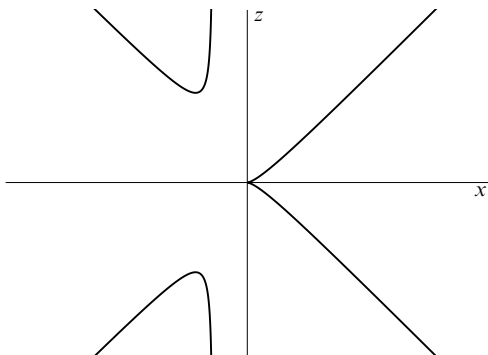

Thus, even if we start from a nonsingular affine variety (that is, one with no singular points), homogenizing the equations and taking the corresponding projective variety may yield a more complicated geometric object. In effect, we are not “seeing the whole picture” in the original affine portion of the variety. In general, given a projective variety  $V \subset \mathbb{P}^n(k)$ , since  $\mathbb{P}^n(k) = \cup_{i=0}^n U_i$ , we may need to consider  $V \cap U_i$  for each  $i = 0, \dots, n$  to see the whole picture of  $V$ .

Our next example shows that simply homogenizing the defining equations can lead to the “wrong” projective variety.

**Example 9.** Consider the affine twisted cubic  $W = \mathbf{V}(x_2 - x_1^2, x_3 - x_1^3)$  in  $\mathbb{R}^3$ . By Proposition 7,  $W = V \cap U_0$  for the projective variety  $V = \mathbf{V}(x_2x_0 - x_1^2, x_3x_0^2 - x_1^3) \subset \mathbb{P}^3(\mathbb{R})$ . As in Example 8, we can ask what part of  $V$  we are “missing” in the affine portion  $W$ . The complement of  $W$  in  $V$  is  $V \cap H$ , where  $H = \mathbf{V}(x_0)$  is the plane at infinity. Thus,  $V \cap H = \mathbf{V}(x_2x_0 - x_1^2, x_3x_0^2 - x_1^3, x_0)$ , and one easily sees that these equations reduce to

$$\begin{aligned} x_1^2 &= 0, \\ x_1^3 &= 0, \\ x_0 &= 0. \end{aligned}$$

The coordinates  $x_2$  and  $x_3$  are arbitrary here, so  $V \cap H$  is the projective line  $\mathbf{V}(x_0, x_1) \subset \mathbb{P}^3(\mathbb{R})$ . Thus we have  $V = W \cup \mathbf{V}(x_0, x_1)$ .

Since the twisted cubic  $W$  is a curve in  $\mathbb{R}^3$ , our intuition suggests that it should only have a finite number of points at infinity (in the exercises, you will see that this is indeed the case). This indicates that  $V$  is probably too big; there should be a smaller

projective variety  $V'$  containing  $W$ . One way to create such a  $V'$  is to homogenize other polynomials that vanish on  $W$ . For example, the parametrization  $(t, t^2, t^3)$  of  $W$  shows that  $x_1x_3 - x_2^2 \in \mathbf{I}(W)$ . Since  $x_1x_3 - x_2^2$  is already homogeneous, we can add it to the defining equations of  $V$  to get

$$V' = \mathbf{V}(x_2x_0 - x_1^2, x_3x_0^2 - x_1^3, x_1x_3 - x_2^2) \subset V.$$

Then  $V'$  is a projective variety with the property that  $V' \cap U_0 = W$ , and in the exercises you will show that  $V' \cap H$  consists of the single point  $p = (0, 0, 0, 1)$ . Thus,  $V' = W \cup \{p\}$ , so that we have a smaller projective variety that restricts to the twisted cubic. The difference between  $V$  and  $V'$  is that  $V$  has an extra component at infinity. In §4, we will show that  $V'$  is the smallest projective variety containing  $W$ .

In Example 9, the process by which we obtained  $V$  was completely straightforward (we homogenized the defining equations of  $W$ ), yet it gave us a projective variety that was too big. This indicates that something more subtle is going on. The complete answer will come in §4, where we will learn an algorithm for finding the smallest projective variety containing  $W \subset k^n \cong U_i$ .

**EXERCISES FOR §2**

1. In this exercise, we will give a more geometric way to describe the construction of  $\mathbb{P}^n(k)$ . Let  $\mathcal{L}$  denote the set of lines through the origin in  $k^{n+1}$ .
  - a. Show that every element of  $\mathcal{L}$  can be represented as the set of scalar multiples of some nonzero vector in  $k^{n+1}$ .
  - b. Show that two nonzero vectors  $v'$  and  $v$  in  $k^{n+1}$  define the same element of  $\mathcal{L}$  if and only if  $v' \sim v$  as in Definition 1.
  - c. Show that there is a one-to-one correspondence between  $\mathbb{P}^n(k)$  and  $\mathcal{L}$ .
2. Complete the proof of Proposition 2 by showing that the mappings  $\phi$  and  $\psi$  defined in the proof are inverses.
3. In this exercise, we will study how lines in  $\mathbb{R}^n$  relate to points at infinity in  $\mathbb{P}^n(\mathbb{R})$ . We will use the decomposition  $\mathbb{P}^n(\mathbb{R}) = \mathbb{R}^n \cup \mathbb{P}^{n-1}(\mathbb{R})$  given in (3). Given a line  $L$  in  $\mathbb{R}^n$ , we can parametrize  $L$  by the formula  $a + bt$ , where  $a \in L$  and  $b$  is a nonzero vector parallel to  $L$ . In coordinates, we write this parametrization as  $(a_1 + b_1t, \dots, a_n + b_nt)$ .
  - a. We can regard  $L$  as lying in  $\mathbb{P}^n(\mathbb{R})$  using the homogeneous coordinates

$$(1, a_1 + b_1t, \dots, a_n + b_nt).$$

To find out what happens as  $t \rightarrow \pm\infty$ , divide by  $t$  to obtain

$$\left(\frac{1}{t}, \frac{a_1}{t} + b_1, \dots, \frac{a_n}{t} + b_n\right).$$

- As  $t \rightarrow \pm\infty$ , what point of  $H = \mathbb{P}^{n-1}(\mathbb{R})$  do you get?
- b. The line  $L$  will have many parametrizations. Show that the point of  $\mathbb{P}^{n-1}(\mathbb{R})$  given by part (a) is the same for all parametrizations of  $L$ . Hint: Two nonzero vectors are parallel if and only if one is a scalar multiple of the other.
  - c. Parts (a) and (b) show that a line  $L$  in  $\mathbb{R}^n$  has a well-defined point at infinity in  $H = \mathbb{P}^{n-1}(\mathbb{R})$ . Show that two lines in  $\mathbb{R}^n$  are parallel if and only if they have the same point at infinity.
4. When  $k = \mathbb{R}$  or  $\mathbb{C}$ , the projective line  $\mathbb{P}^1(k)$  is easy to visualize.



- a. In the text, we called  $\mathbb{P}^1(\mathbb{C}) = \mathbb{C} \cup \{\infty\}$  the Riemann sphere. To see why this name is justified, use the parametrization from Exercise 6 of Chapter 1, §3 to show how the plane corresponds to the sphere minus the north pole. Then explain why we can regard  $\mathbb{C} \cup \{\infty\}$  as a sphere.
- b. What common geometric object can we use to represent  $\mathbb{P}^1(\mathbb{R})$ ? Illustrate your reasoning with a picture.

5. Prove Corollary 3.

6. This problem studies the subsets  $U_i \subset \mathbb{P}^n(k)$ .

- a. In  $\mathbb{P}^4(k)$ , identify the points that are in the subsets  $U_2$ ,  $U_2 \cap U_3$ , and  $U_1 \cap U_3 \cap U_4$ .
- b. Give an identification of  $\mathbb{P}^4(k) - U_2$ ,  $\mathbb{P}^4(k) - (U_2 \cup U_3)$ , and  $\mathbb{P}^4(k) - (U_1 \cup U_3 \cup U_4)$  as a “copy” of another projective space.
- c. In  $\mathbb{P}^4(k)$ , which points are  $\bigcap_{i=0}^4 U_i$ ?
- d. In general, describe the subset  $U_{i_1} \cap \dots \cap U_{i_s} \subset \mathbb{P}^n(k)$ , where

$$1 \leq i_1 < i_2 < \dots < i_s \leq n.$$

7. In this exercise, we will study when a nonhomogeneous polynomial has a well-defined zero set in  $\mathbb{P}^n(k)$ . Let  $k$  be an infinite field. We will show that if  $f \in k[x_0, \dots, x_n]$  is *not* homogeneous, but  $f$  vanishes on all homogeneous coordinates of some  $p \in \mathbb{P}^n(k)$ , then each of the homogeneous components  $f_i$  of  $f$  (see Definition 6 of Chapter 7, §1) must vanish at  $p$ .

- a. Write  $f$  as a sum of its homogeneous components  $f = \sum_i f_i$ . If  $p = (a_0, \dots, a_n)$ , then show that

$$\begin{aligned} f(\lambda a_0, \dots, \lambda a_n) &= \sum_i f_i(\lambda a_0, \dots, \lambda a_n) \\ &= \sum_i \lambda^i f_i(a_0, \dots, a_n). \end{aligned}$$

- b. Deduce that if  $f$  vanishes for all  $\lambda \neq 0 \in k$ , then  $f_i(a_0, \dots, a_n) = 0$  for all  $i$ .

8. By dehomogenizing the defining equations of the projective variety  $V$ , find equations for the indicated affine varieties.

- a. Let  $\mathbb{P}^2(\mathbb{R})$  have homogeneous coordinates  $(x, y, z)$  and let  $V = \mathbf{V}(x^2 + y^2 - z^2) \subset \mathbb{P}^2(\mathbb{R})$ . Find equations for  $V \cap U_0$ ,  $V \cap U_2$ . (Here  $U_0$  is where  $x \neq 0$  and  $U_2$  is where  $z \neq 0$ .) Sketch each of these curves and think about what this says about the projective variety  $V$ .

- b.  $V = \mathbf{V}(x_0x_2 - x_3x_4, x_0^2x_3 - x_1x_2^2) \subset \mathbb{P}^4(k)$  and find equations for the affine variety  $V \cap U_0 \subset k^4$ . Do the same for  $V \cap U_3$ .

9. Let  $V = \mathbf{V}(f_1, \dots, f_s)$  be a projective variety defined by homogeneous polynomials  $f_i \in k[x_0, \dots, x_n]$ . Show that the subset  $W = V \cap U_i$ , can be identified with the affine variety  $\mathbf{V}(g_1, \dots, g_s) \subset k^n$  defined by the dehomogenized polynomials

$$g_j(x_1, \dots, x_i, x_{i+1}, \dots, x_n) = f_j(x_1, \dots, x_i, 1, x_{i+1}, \dots, x_n).$$

Hint: Follow the proof of Proposition 6, using Corollary 3.

10. Prove Proposition 7.

11. Using part (iv) of Proposition 7, show that if  $f \in k[x_1, \dots, x_n]$  and  $F \in k[x_0, \dots, x_n]$  is any homogeneous polynomial satisfying  $F(1, x_1, \dots, x_n) = f(x_1, \dots, x_n)$ , then  $F = x_0^e f^h$  for some  $e \geq 0$ .

12. What happens if we apply the homogenization process of Proposition 7 to a polynomial  $g$  that is itself homogeneous?

13. In Example 8, we were led to consider the variety  $W' = \mathbf{V}(z^2 - x^3 + xz^2) \subset k^2$ . Show that  $(x, z) = (0, 0)$  is a singular point of  $W'$ . Hint: Use Definition 3 from Chapter 3, §4.
14. For each of the following affine varieties  $W$ , apply the homogenization process given in Proposition 7 to write  $W = V \cap U_0$ , where  $V$  is a projective variety. In each case identify  $V - W = V \cap H$ , where  $H$  is the hyperplane at infinity.
- $W = \mathbf{V}(y^2 - x^3 - ax - b) \subset \mathbb{R}^2$ ,  $a, b \in \mathbb{R}$ . Is the point  $V \cap H$  singular here? Hint: Let the homogeneous coordinates on  $\mathbb{P}^2(\mathbb{R})$  be  $(z, x, y)$ , so that  $U_0$  is where  $z \neq 0$ .
  - $W = \mathbf{V}(x_1x_3 - x_2^2, x_1^2 - x_2) \subset \mathbb{R}^3$ . Is there an extra component at infinity here?
  - $W = \mathbf{V}(x_3^2 - x_1^2 - x_2^2) \subset \mathbb{R}^3$ .
15. From Example 9, consider the twisted cubic  $W = \mathbf{V}(x_2 - x_1^2, x_3 - x_1^3) \subset \mathbb{R}^3$ .
- If we parametrize  $W$  by  $(t, t^2, t^3)$  in  $\mathbb{R}^3$ , show that as  $t \rightarrow \pm\infty$ , the point  $(1, t, t^2, t^3)$  in  $\mathbb{P}^3(\mathbb{R})$  approaches  $(0, 0, 0, 1)$ . Thus, we expect  $W$  to have one point at infinity.
  - Now consider the projective variety

$$V' = \mathbf{V}(x_2x_0 - x_1^2, x_3x_0^2 - x_1^3, x_1x_3 - x_2^2) \subset \mathbb{P}^3(\mathbb{R}).$$

Show that  $V' \cap U_0 = W$  and that  $V' \cap H = \{(0, 0, 0, 1)\}$ .

- Let  $V = \mathbf{V}(x_2x_0 - x_1^2, x_3x_0^2 - x_1^3)$  be as in Example 9. Prove that  $V = V' \cup \mathbf{V}(x_0, x_1)$ . This shows that  $V$  is a union of two proper projective varieties.
16. A homogeneous polynomial  $f \in k[x_0, \dots, x_n]$  can also be used to define the *affine* variety  $C = \mathbf{V}_a(f)$  in  $k^{n+1}$ , where the subscript denotes we are working in affine space. We call  $C$  the *affine cone* over the projective variety  $V = \mathbf{V}(f) \subset \mathbb{P}^n(k)$ . We will see why this is so in this exercise.
- Show that if  $C$  contains the point  $P \neq (0, \dots, 0)$ , then  $C$  contains the whole line through the origin in  $k^{n+1}$  spanned by  $P$ .
  - Now consider the point  $p$  in  $\mathbb{P}^n(k)$  with homogeneous coordinates  $P$ . Show that  $p$  is in the projective variety  $V$  if and only if the line through the origin determined by  $P$  is contained in  $C$ . Hint: See (1) and Exercise 1.
  - Deduce that  $C$  is the union of the collection of lines through the origin in  $k^{n+1}$  corresponding to the points in  $V$  via (1). This explains the reason for the “cone” terminology since an ordinary cone is also a union of lines through the origin. Such a cone is given by part (c) of Exercise 14.
17. Homogeneous polynomials satisfy an important relation known as *Euler’s Formula*. Let  $f \in k[x_0, \dots, x_n]$  be homogeneous of total degree  $d$ . Then Euler’s Formula states that

$$\sum_{i=0}^n x_i \cdot \frac{\partial f}{\partial x_i} = d \cdot f.$$

- Verify Euler’s Formula for the homogeneous polynomial  $f = x_0^3 - x_1x_2^2 + 2x_1x_3^2$ .
  - Prove Euler’s Formula (in the case  $k = \mathbb{R}$ ) by considering  $f(\lambda x_0, \dots, \lambda x_n)$  as a function of  $\lambda$  and differentiating with respect to  $\lambda$  using the chain rule.
18. In this exercise, we will consider the set of hyperplanes in  $\mathbb{P}^n(k)$  in greater detail.
- Show that two homogeneous linear polynomials,

$$\begin{aligned} 0 &= a_0x_0 + \dots + a_nx_n, \\ 0 &= b_0x_0 + \dots + b_nx_n, \end{aligned}$$

define the same hyperplane in  $\mathbb{P}^n(k)$  if and only if there is some  $\lambda \neq 0 \in k$  such that  $b_i = \lambda a_i$  for all  $i = 0, \dots, n$ . Hint: Generalize the argument given for Exercise 11 of §1.

- b. Show that the map sending the hyperplane with equation  $a_0x_0 + \dots + a_nx_n = 0$  to the vector  $(a_0, \dots, a_n)$  gives a one-to-one correspondence

$$\phi : \{\text{hyperplanes in } \mathbb{P}^n(k)\} \rightarrow (k^{n+1} - \{0\}) / \sim,$$

where  $\sim$  is the equivalence relation of Definition 1. The set on the left is called the *dual projective space* and is denoted  $\mathbb{P}^n(k)^\vee$ . Geometrically, the points of  $\mathbb{P}^n(k)^\vee$  are hyperplanes in  $\mathbb{P}^n(k)$ .

- c. Describe the subset of  $\mathbb{P}^n(k)^\vee$  corresponding to the hyperplanes containing  $p = (1, 0, \dots, 0)$ .
19. Let  $k$  be an algebraically closed field ( $\mathbb{C}$ , for example). Show that every homogeneous polynomial  $f(x_0, x_1)$  in two variables with coefficients in  $k$  can be completely factored into linear homogeneous polynomials in  $k[x_0, x_1]$ :

$$f(x_0, x_1) = \prod_{i=1}^d (a_i x_0 + b_i x_1),$$

where  $d$  is the total degree of  $f$ . Hint: First dehomogenize  $f$ .

20. In §4 of Chapter 5, we introduced the *pencil* defined by two hypersurfaces  $V = \mathbf{V}(f)$ ,  $W = \mathbf{V}(g)$ . The elements of the pencil were the hypersurfaces  $\mathbf{V}(f + cg)$  for  $c \in k$ . Setting  $c = 0$ , we obtain  $V$  as an element of the pencil. However,  $W$  is not (usually) an element of the pencil when it is defined in this way. To include  $W$  in the pencil, we can proceed as follows.
- a. Let  $(a, b)$  be homogeneous coordinates in  $\mathbb{P}^1(k)$ . Show that  $\mathbf{V}(af + bg)$  is well-defined in the sense that all homogeneous coordinates  $(a, b)$  for a given point in  $\mathbb{P}^1(k)$  yield the same variety  $\mathbf{V}(af + bg)$ . Thus, we obtain a family of varieties parametrized by  $\mathbb{P}^1(k)$ , which is also called the *pencil* of varieties defined by  $V$  and  $W$ .
- b. Show that both  $V$  and  $W$  are contained in the pencil  $\mathbf{V}(af + bg)$ .
- c. Let  $k = \mathbb{C}$ . Show that every affine curve  $\mathbf{V}(f) \subset \mathbb{C}^2$  defined by a polynomial  $f$  of total degree  $d$  is contained in a pencil of curves  $\mathbf{V}(aF + bG)$  parametrized by  $\mathbb{P}^1(\mathbb{C})$ , where  $\mathbf{V}(F)$  is a union of lines and  $G$  is a polynomial of degree strictly less than  $d$ . Hint: Consider the homogeneous components of  $f$ . Exercise 19 will be useful.
21. When we have a curve parametrized by  $t \in k$ , there are many situations where we want to let  $t \rightarrow \infty$ . Since  $\mathbb{P}^1(k) = k \cup \{\infty\}$ , this suggests that we should let our parameter space be  $\mathbb{P}^1(k)$ . Here are two examples of how this works.
- a. Consider the parametrization  $(x, y) = ((1 + t^2)/(1 - t^2), 2t/(1 - t^2))$  of the hyperbola  $x^2 - y^2 = 1$  in  $\mathbb{R}^2$ . To make this projective, we first work in  $\mathbb{P}^2(\mathbb{R})$  and write the parametrization as

$$((1 + t^2)/(1 - t^2), 2t/(1 - t^2), 1) = (1 + t^2, 2t, 1 - t^2)$$

(see Exercise 3 of §1). The next step is to make  $t$  projective. Given  $(a, b) \in \mathbb{P}^1(\mathbb{R})$ , we can write it as  $(1, t) = (1, b/a)$  provided  $a \neq 0$ . Now substitute  $t = b/a$  into the right-hand side and clear denominators. Explain why this gives a well-defined map  $\mathbb{P}^1(\mathbb{R}) \rightarrow \mathbb{P}^2(\mathbb{R})$ .

- b. The twisted cubic in  $\mathbb{R}^3$  is parametrized by  $(t, t^2, t^3)$ . Apply the method of part (a) to obtain a projective parametrization  $\mathbb{P}^1(\mathbb{R}) \rightarrow \mathbb{P}^3(\mathbb{R})$  and show that the image of this map is precisely the projective variety  $V'$  from Example 9.

## §3 The Projective Algebra–Geometry Dictionary

In this section, we will study the algebra–geometry dictionary for projective varieties. Our goal is to generalize the theorems from Chapter 4 concerning the **V** and **I** correspondences to the projective case, and, in particular, we will prove a projective version of the Nullstellensatz.

To begin, we note one difference between the affine and projective cases on the algebraic side of the dictionary. Namely, in Definition 5 of §2, we introduced projective varieties as the common zeros of collections of *homogeneous* polynomials. But being homogeneous is *not* preserved under the sum operation in  $k[x_0, \dots, x_n]$ . For example, if we add two homogeneous polynomials of different total degrees, the sum will *never* be homogeneous. Thus, if we form the ideal  $I = \langle f_1, \dots, f_s \rangle \subset k[x_0, \dots, x_n]$  generated by a collection of homogeneous polynomials,  $I$  will contain many *non-homogeneous* polynomials and these would not be candidates for the defining equations of a projective variety.

Nevertheless, each element of  $I$  vanishes on all homogeneous coordinates of every point of  $V = \mathbf{V}(f_1, \dots, f_s)$ . This follows because each  $g \in I$  has the form

$$(1) \quad g = \sum_{j=1}^s A_j f_j$$

for some  $A_j \in k[x_0, \dots, x_n]$ . Substituting any homogeneous coordinates of a point in  $V$  into  $g$  will yield zero since each  $f_j$  is zero there.

A more important observation concerns the homogeneous components of  $g$ . Suppose we expand each  $A_j$  as the sum of its homogeneous components:

$$A_j = \sum_{i=1}^d A_{ji}.$$

If we substitute these expressions into (1) and collect terms of the same total degree, it can be shown that the homogeneous components of  $g$  also lie in the ideal  $I = \langle f_1, \dots, f_s \rangle$ . You will prove this claim in Exercise 2.

Thus, although  $I$  contains nonhomogeneous elements  $g$ , we see that  $I$  also contains the homogeneous components of  $g$ . This observation motivates the following definition of a special class of ideals in  $k[x_0, \dots, x_n]$ .

**Definition 1.** An ideal  $I$  in  $k[x_0, \dots, x_n]$  is said to be **homogeneous** if for each  $f \in I$ , the homogeneous components  $f_i$  of  $f$  are in  $I$  as well.

Most ideals *do not* have this property. For instance, let  $I = \langle y - x^2 \rangle \subset k[x, y]$ . The homogeneous components of  $f = y - x^2$  are  $f_1 = y$  and  $f_2 = -x^2$ . Neither of these polynomials is in  $I$  since neither is a multiple of  $y - x^2$ . Hence,  $I$  is not a homogeneous ideal. However, we have the following useful characterization of when an ideal is homogeneous.

**Theorem 2.** *Let  $I \subset k[x_0, \dots, x_n]$  be an ideal. Then the following are equivalent:*

- (i)  *$I$  is a homogeneous ideal of  $k[x_0, \dots, x_n]$ .*
- (ii)  *$I = \langle f_1, \dots, f_s \rangle$ , where  $f_1, \dots, f_s$  are homogeneous polynomials.*
- (iii) *A reduced Groebner basis of  $I$  (with respect to any monomial ordering) consists of homogeneous polynomials.*

**Proof.** The proof of (ii)  $\Rightarrow$  (i) was sketched above (see also Exercise 2). To prove (i)  $\Rightarrow$  (ii), let  $I$  be a homogeneous ideal. By the Hilbert Basis Theorem, we have  $I = \langle F_1, \dots, F_t \rangle$  for some polynomials  $F_j \in k[x_0, \dots, x_n]$  (not necessarily homogeneous). If we write  $F_j$  as the sum of its homogeneous components, say  $F_j = \sum_i F_{ji}$ , then each  $F_{ji} \in I$  since  $I$  is homogeneous. Let  $I'$  be the ideal generated by the homogeneous polynomials  $F_{ji}$ . Then  $I \subset I'$  since each  $F_j$  is a sum of generators of  $I'$ . On the other hand,  $I' \subset I$  since each of the homogeneous components of  $F_j$  is in  $I$ . This proves  $I = I'$  and it follows that  $I$  has a basis of homogeneous polynomials. Finally, the equivalence (ii)  $\Leftrightarrow$  (iii) will be covered in Exercise 3.  $\square$

As a result of Theorem 2, for any homogeneous ideal  $I \subset k[x_0, \dots, x_n]$  we may define

$$\mathbf{V}(I) = \{p \in \mathbb{P}^n(k) : f(p) = 0 \text{ for all } f \in I\},$$

as in the affine case. We can prove that  $\mathbf{V}(I)$  is a projective variety as follows.

**Proposition 3.** *Let  $I \subset k[x_0, \dots, x_n]$  be a homogeneous ideal and suppose that  $I = \langle f_1, \dots, f_s \rangle$ , where  $f_1, \dots, f_s$  are homogeneous. Then*

$$\mathbf{V}(I) = \mathbf{V}(f_1, \dots, f_s),$$

*so that  $\mathbf{V}(I)$  is a projective variety.*

**Proof.** We leave the easy proof as an exercise.  $\square$

One way to create a homogeneous ideal is to consider the ideal generated by the defining equations of a projective variety. But there is another way that a projective variety can give us a homogeneous ideal.

**Proposition 4.** *Let  $V \subset \mathbb{P}^n(k)$  be a projective variety and let*

$$\mathbf{I}(V) = \{f \in k[x_0, \dots, x_n] : f(a_0, \dots, a_n) = 0 \text{ for all } (a_0, \dots, a_n) \in V\}.$$

*(This means that  $f$  must be zero for all homogeneous coordinates of all points in  $V$ .) If  $k$  is infinite, then  $\mathbf{I}(V)$  is a homogeneous ideal in  $k[x_0, \dots, x_n]$ .*

**Proof.**  $\mathbf{I}(V)$  is closed under sums and closed under products by elements of  $k[x_0, \dots, x_n]$  by an argument exactly parallel to the one for the affine case. Thus,  $\mathbf{I}(V)$  is an ideal in  $k[x_0, \dots, x_n]$ . Now take  $f \in \mathbf{I}(V)$  and fix a point  $p \in V$ . By assumption,  $f$  vanishes at all homogeneous coordinates  $(a_0, \dots, a_n)$  of  $p$ . Since  $k$  is infinite,

Exercise 7 of §2 then implies that each homogeneous component  $f_i$  of  $f$  vanishes at  $(a_0, \dots, a_n)$ . This shows that  $f_i \in \mathbf{I}(V)$  and, hence,  $\mathbf{I}(V)$  is homogeneous.  $\square$

Thus, we have all the ingredients of a dictionary relating projective varieties in  $\mathbb{P}^n(k)$  and homogeneous ideals in  $k[x_0, \dots, x_n]$ . The following theorem is a direct generalization of part (i) of Theorem 7 of Chapter 4, §2 (the affine ideal-variety correspondence).

**Theorem 5.** *Let  $k$  be an infinite field. Then the maps*

$$\text{projective varieties} \xrightarrow{\mathbf{I}} \text{homogeneous ideals}$$

and

$$\text{homogeneous ideals} \xrightarrow{\mathbf{V}} \text{projective varieties}$$

are inclusion-reversing. Furthermore, for any projective variety, we have

$$\mathbf{V}(\mathbf{I}(V)) = V.$$

so that  $\mathbf{I}$  is always one-to-one.

**Proof.** The proof is the same as in the affine case.  $\square$

To illustrate the use of this theorem, let us show that every projective variety can be decomposed to irreducible components. As in the affine case, a variety  $V \subset \mathbb{P}^n(k)$  is *irreducible* if it cannot be written as a union of two strictly smaller projective varieties.

**Theorem 6.** *Let  $k$  be an infinite field.*

- (i) *Given a descending chain of projective varieties in  $\mathbb{P}^n(k)$ ,*

$$V_1 \supset V_2 \supset V_3 \supset \dots,$$

*there is an integer  $N$  such that  $V_N = V_{N+1} = \dots$ .*

- (ii) *Every projective variety  $V \subset \mathbb{P}^n(k)$  can be written uniquely as a finite union of irreducible projective varieties*

$$V = V_1 \cup \dots \cup V_m,$$

*where  $V_i \not\subset V_j$  for  $i \neq j$ .*

**Proof.** Since  $\mathbf{I}$  is inclusion-reversing, we get the ascending chain of homogeneous ideals

$$\mathbf{I}(V_1) \subset \mathbf{I}(V_2) \subset \mathbf{I}(V_3) \subset \dots$$

in  $k[x_0, \dots, x_n]$ . Then the Ascending Chain Condition (Theorem 7 of Chapter 2, §5) implies that  $\mathbf{I}(V_N) = \mathbf{I}(V_{N+1}) = \dots$  for some  $N$ . By Theorem 5,  $\mathbf{I}$  is one-to-one and (i) follows immediately.

As in the affine case, (ii) is an immediate consequence of (i). See Theorems 2 and 4 of Chapter 4, §6.  $\square$

The relation between operations such as sums, products, and intersections of homogeneous ideals and the corresponding operations on projective varieties is also the same as in affine space. We will consider these topics in more detail in the exercises below.

We define the radical of a homogeneous ideal as usual:

$$\sqrt{I} = \{f \in k[x_0, \dots, x_n] : f^m \in I \text{ for some } m \geq 1\}.$$

As we might hope, the radical of a homogeneous ideal is always itself homogeneous.

**Proposition 7.** *Let  $I \subset k[x_0, \dots, x_n]$  be a homogeneous ideal. Then  $\sqrt{I}$  is also a homogeneous ideal.*

**Proof.** If  $f \in \sqrt{I}$ , then  $f^m \in I$  for some  $m \geq 1$ . If  $f \neq 0$ , decompose  $f$  into its homogeneous components

$$f = \sum_i f_i = f_{\max} + \sum_{i < \max} f_i,$$

where  $f_{\max}$  is the nonzero homogeneous component of maximal total degree in  $f$ . Expanding the power  $f^m$ , it is easy to show that

$$(f^m)_{\max} = (f_{\max})^m.$$

Since  $I$  is a homogeneous ideal,  $(f^m)_{\max} \in I$ . Hence,  $(f_{\max})^m \in I$ , which shows that  $f_{\max} \in \sqrt{I}$ .

If we let  $g = f - f_{\max} \in \sqrt{I}$  and repeat the argument, we get  $g_{\max} \in \sqrt{I}$ . But  $g_{\max}$  is also one of the homogeneous components of  $f$ . Applying this reasoning repeatedly shows that all homogeneous components of  $f$  are in  $\sqrt{I}$ . Since this is true for all  $f \in \sqrt{I}$ , Definition 1 implies that  $\sqrt{I}$  is a homogeneous ideal.  $\square$

The final part of the algebra–geometry dictionary concerns what happens over an algebraically closed field  $k$ . Here, we expect an especially close relation between projective varieties and homogeneous ideals. In the affine case, the link was provided by two theorems proved in Chapter 4, the Weak Nullstellensatz and the Strong Nullstellensatz. Let us recall what these theorems tell us about an ideal  $I \subset k[x_1, \dots, x_n]$ :

- (The Weak Nullstellensatz)  $\mathbf{V}_a(I) = \emptyset$  in  $k^n \iff I = k[x_1, \dots, x_n]$ .
- (The Strong Nullstellensatz)  $\sqrt{I} = \mathbf{I}_a(\mathbf{V}_a(I))$  in  $k[x_1, \dots, x_n]$ .

(To prevent confusion, we use  $\mathbf{I}_a$  and  $\mathbf{V}_a$  to denote the affine versions of  $\mathbf{I}$  and  $\mathbf{V}$ .) It is natural to ask if these results extend to projective varieties and homogeneous ideals.

The answer, surprisingly, is *no*. In particular, the Weak Nullstellensatz fails for certain homogeneous ideals. To see how this can happen, consider the ideal  $I = \langle x_0, \dots, x_n \rangle \subset \mathbb{C}[x_0, \dots, x_n]$ . Then  $\mathbf{V}(I) \subset \mathbb{P}^n(\mathbb{C})$  is defined by the equations  $x_0 = \dots = x_n = 0$ . The only solution is  $(0, \dots, 0)$ , but this is impossible since we never allow all homogeneous coordinates to vanish simultaneously. It follows that  $\mathbf{V}(I) = \emptyset$ , yet  $I \neq \mathbb{C}[x_0, \dots, x_n]$ .

Fortunately,  $I = \langle x_0, \dots, x_n \rangle$  is one of the few ideals for which  $\mathbf{V}(I) = \emptyset$ . The following projective version of the Weak Nullstellensatz describes *all* homogeneous ideals with no projective solutions.

**Theorem 8 (The Projective Weak Nullstellensatz).** *Let  $k$  be algebraically closed and let  $I$  be a homogeneous ideal in  $k[x_0, \dots, x_n]$ . Then the following are equivalent:*

- (i)  $\mathbf{V}(I) \subset \mathbb{P}^n(k)$  is empty.
- (ii) Let  $G$  be a reduced Groebner basis for  $I$  (with respect to some monomial ordering). Then for each  $0 \leq i \leq n$ , there is  $g \in G$  such that  $\text{LT}(g)$  is a nonnegative power of  $x_i$ .
- (iii) For each  $0 \leq i \leq n$ , there is an integer  $m_i \geq 0$  such that  $x_i^{m_i} \in I$ .
- (iv) There is some  $r \geq 1$  such that  $\langle x_0, \dots, x_n \rangle^r \subset I$ .

**Proof.** The ideal  $I$  gives us the projective variety  $V = \mathbf{V}(I) \subset \mathbb{P}^n(k)$ . In this proof, we will also work with the affine variety  $C_V = \mathbf{V}_a(I) \subset k^{n+1}$ . Note that  $C_V$  uses the same ideal  $I$ , but now we look for solutions in the affine space  $k^{n+1}$ . We call  $C_V$  the affine cone of  $V$ . If we interpret points in  $\mathbb{P}^n(k)$  as lines through the origin in  $k^{n+1}$ , then  $C_V$  is the union of the lines determined by the points of  $V$  (see Exercise 16 of §2 for the details of how this works). In particular,  $C_V$  contains all homogeneous coordinates of the points in  $V$ .

To prove (ii)  $\Rightarrow$  (i), first suppose that we have a Groebner basis where, for each  $i$ , there is  $g \in G$  with  $\text{LT}(g) = x_i^{m_i}$  for some  $m_i \geq 0$ . Then Theorem 6 of Chapter 5, §3 implies that  $C_V$  is a finite set. But suppose there is a point  $p \in V$ . Then all homogeneous coordinates of  $p$  lie in  $C_V$ . If we write these in the form  $\lambda(a_0, \dots, a_n)$ , we see that there are infinitely many since  $k$  is algebraically closed and hence infinite. This contradiction shows that  $V = \mathbf{V}(I) = \emptyset$ .

Turning to (iii)  $\Rightarrow$  (ii), let  $G$  be a reduced Groebner basis for  $I$ . Then  $x_i^{m_i} \in I$  implies that the leading term of some  $g \in G$  divides  $x_i^{m_i}$ , so that  $\text{LT}(g)$  must be a power of  $x_i$ .

The proof of (iv)  $\Rightarrow$  (iii) is obvious since  $\langle x_0, \dots, x_n \rangle^r \subset I$  implies  $x_i^r \in I$  for all  $i$ . It remains to prove (i)  $\Rightarrow$  (iv). We first observe that  $V = \emptyset$  implies

$$C_V \subset \{(0, \dots, 0)\} \text{ in } k^{n+1}.$$

This follows because a nonzero point  $(a_0, \dots, a_n)$  in the affine cone  $C_V$  would give homogeneous coordinates of a point in  $V \subset \mathbb{P}^n(k)$ , which would contradict  $V = \emptyset$ . Then, applying  $\mathbf{I}_a$ , we obtain

$$\mathbf{I}_a(\{(0, \dots, 0)\}) \subset \mathbf{I}_a(C_V).$$

We know  $\mathbf{I}_a(\{(0, \dots, 0)\}) = \langle x_0, \dots, x_n \rangle$  (see Exercise 7 of Chapter 4, §5) and the affine version of the Strong Nullstellensatz implies  $\mathbf{I}_a(C_V) = \mathbf{I}_a(\mathbf{V}_a(I)) = \sqrt{I}$  since  $k$  is algebraically closed. Combining these facts, we conclude that

$$\langle x_0, \dots, x_n \rangle \subset \sqrt{I}.$$

However, in Exercise 12 of Chapter 4, §3 we showed that if some ideal is contained in  $\sqrt{I}$ , then a power of the ideal lies in  $I$ . This completes the proof of the theorem.  $\square$

From part (ii) of the theorem, we get an algorithm for determining if a homogeneous ideal has projective solutions over an algebraically closed field. In Exercise 10, we will discuss other conditions which are equivalent to  $\mathbf{V}(I) = \emptyset$  in  $\mathbb{P}^n(k)$ .



Once we exclude the ideals described in Theorem 8, we get the following form of the Nullstellensatz for projective varieties.

**Theorem 9 (The Projective Strong Nullstellensatz).** *Let  $k$  be an algebraically closed field and let  $I$  be a homogeneous ideal in  $k[x_0, \dots, x_n]$ . If  $V = \mathbf{V}(I)$  is a nonempty projective variety in  $\mathbb{P}^n(k)$ , then we have*

$$\mathbf{I}(\mathbf{V}(I)) = \sqrt{I}.$$

**Proof.** As in the proof of Theorem 8, we will work with the projective variety  $V = \mathbf{V}(I) \subset \mathbb{P}^n(k)$  and its affine cone  $C_V = \mathbf{V}_a(I) \subset k^{n+1}$ . We first claim that

$$(2) \quad \mathbf{I}_a(C_V) = \mathbf{I}(V)$$

when  $V \neq \emptyset$ . To see this, suppose that  $f \in \mathbf{I}_a(C_V)$ . Given  $p \in V$ , any homogeneous coordinates of  $p$  lie in  $C_V$ , so that  $f$  vanishes at all homogeneous coordinates of  $p$ . By definition, this implies  $f \in \mathbf{I}(V)$ . Conversely, take  $f \in \mathbf{I}(V)$ . Since any nonzero point of  $C_V$  gives homogeneous coordinates for a point in  $V$ , it follows that  $f$  vanishes on  $C_V - \{0\}$ . It remains to show that  $f$  vanishes at the origin. Since  $\mathbf{I}(V)$  is a homogeneous ideal, we know that the homogeneous components  $f_i$  of  $f$  also vanish on  $V$ . In particular, the constant term of  $f$ , which is the homogeneous component  $f_0$  of total degree 0, must vanish on  $V$ . Since  $V \neq \emptyset$ , this forces  $f_0 = 0$ , which means that  $f$  vanishes at the origin. Hence,  $f \in \mathbf{I}_a(C_V)$  and (2) is proved.

By the affine form of the Strong Nullstellensatz, we know that  $\sqrt{I} = \mathbf{I}_a(\mathbf{V}_a(I))$ . Then, using (2), we obtain

$$\sqrt{I} = \mathbf{I}_a(\mathbf{V}_a(I)) = \mathbf{I}_a(C_V) = \mathbf{I}(V) = \mathbf{I}(\mathbf{V}(I)).$$

which completes the proof of the theorem. □

Now that we have the Nullstellensatz, we can complete the projective ideal–variety correspondence begun in Theorem 5. A radical homogeneous ideal in  $k[x_0, \dots, x_n]$  is a homogeneous ideal satisfying  $\sqrt{I} = I$ . As in the affine case, we have a one-to-one correspondence between projective varieties and radical homogeneous ideals, provided we exclude the cases  $\sqrt{I} = \langle x_0, \dots, x_n \rangle$  and  $\sqrt{I} = \langle 1 \rangle$ .

**Theorem 10.** *Let  $k$  be an algebraically closed field. If we restrict the correspondences of Theorem 5 to nonempty projective varieties and radical homogeneous ideals properly contained in  $\langle x_0, \dots, x_n \rangle$ , then*

$$\{\text{nonempty projective varieties}\} \xrightarrow{\mathbf{I}} \left\{ \begin{array}{l} \text{radical homogeneous ideals} \\ \text{properly contained in } \langle x_0, \dots, x_n \rangle \end{array} \right\}$$

and

$$\left\{ \begin{array}{l} \text{radical homogeneous ideals} \\ \text{properly contained in } \langle x_0, \dots, x_n \rangle \end{array} \right\} \xrightarrow{\mathbf{V}} \{\text{nonempty projective varieties}\}$$

are inclusion-reversing bijections which are inverses of each other.

**Proof.** First, it is an easy consequence of Theorem 8 that the only radical homogeneous ideals  $I$  with  $\mathbf{V}(I) = \emptyset$  are  $\langle x_0, \dots, x_n \rangle$  and  $k[x_0, \dots, x_n]$ . See Exercise 10 for the details. A second observation is that if  $I$  is a homogeneous ideal different from  $k[x_0, \dots, x_n]$ , then  $I \subset \langle x_0, \dots, x_n \rangle$ . This will also be covered in Exercise 9.

These observations show that the radical homogeneous ideals with  $\mathbf{V}(I) \neq \emptyset$  are precisely those which satisfy  $I \subsetneq \langle x_0, \dots, x_n \rangle$ . Then the rest of the theorem follows as in the affine case, using Theorem 9.  $\square$

We also have a correspondence between *irreducible* projective varieties and homogeneous *prime* ideals, which will be studied in the exercises.

### EXERCISES FOR §3

- In this exercise, you will study the question of determining when a principal ideal  $I = \langle f \rangle$  is homogeneous by elementary methods.
  - Show that  $I = \langle x^2y - x^3 \rangle$  is a homogeneous ideal in  $k[x, y]$  without appealing to Theorem 2. Hint: Each element of  $I$  has the form  $g = A \cdot (x^2y - x^3)$ . Write  $A$  as the sum of its homogeneous components and use this to determine the homogeneous components of  $g$ .
  - Show that  $\langle f \rangle \subset k[x_0, \dots, x_n]$  is a homogeneous ideal if and only if  $f$  is a homogeneous polynomial without using Theorem 2.
- This exercise gives some useful properties of the homogeneous components of polynomials.
  - Show that if  $f = \sum_i f_i$  and  $g = \sum_i g_i$  are the expansions of two polynomials as the sums of their homogeneous components, then  $f = g$  if and only if  $f_i = g_i$  for all  $i$ .
  - Show that if  $f = \sum_i f_i$  and  $g = \sum_j g_j$  are the expansions of two polynomials as the sums of their homogeneous components, then the homogeneous components  $h_k$  of the product  $h = f \cdot g$  are given by  $h_k = \sum_{i+j=k} f_i \cdot g_j$ .
  - Use parts (a) and (b) to carry out the proof (sketched in the text) of the implication (ii)  $\Rightarrow$  (i) from Theorem 2.
- This exercise will study how the algorithms of Chapter 2 interact with homogeneous polynomials.
  - Suppose we use the division algorithm to divide a homogeneous polynomial  $f$  by homogeneous polynomials  $f_1, \dots, f_s$ . This gives an expression of the form  $f = a_1 f_1 + \dots + a_s f_s + r$ . Prove that the quotients  $a_1, \dots, a_s$  and remainder  $r$  are homogeneous polynomials (possibly zero). What is the total degree of  $r$ ?
  - If  $f, g$  are homogeneous polynomials, prove that the S-polynomial  $S(f, g)$  is homogeneous.
  - By analyzing the Buchberger algorithm, show that a homogeneous ideal has a homogeneous Groebner basis.
  - Prove the implication (ii)  $\Leftrightarrow$  (iii) of Theorem 2.
- Suppose that an ideal  $I \subset k[x_0, \dots, x_n]$  has a basis  $G$  consisting of homogeneous polynomials.
  - Prove that  $G$  is a Groebner basis for  $I$  with respect to lex order if and only if it is a Groebner basis for  $I$  with respect to grlex (assuming that the variables are ordered the same way).
  - Conclude that, for a homogeneous ideal, the reduced Groebner basis for lex and grlex are the same.
- Prove Proposition 3.

6. In this exercise we study the algebraic operations on ideals introduced in Chapter 4 for homogeneous ideals. Let  $I_1, \dots, I_l$  be homogeneous ideals in  $k[x_0, \dots, x_n]$ .
- Show that the ideal sum  $I_1 + \dots + I_l$  is also homogeneous. Hint: Use Theorem 2.
  - Show that the intersection  $I_1 \cap \dots \cap I_l$  is also a homogeneous ideal.
  - Show that the ideal product  $I_1 \cdots I_l$  is a homogeneous ideal.
7. The interaction between the algebraic operations on ideals in Exercise 6 and the corresponding operations on projective varieties is the same as in the affine case. Let  $I_1, \dots, I_l$  be homogeneous ideals in  $k[x_0, \dots, x_n]$  and let  $V_i = \mathbf{V}(I_i)$  be the corresponding projective variety in  $\mathbb{P}^n(k)$ .
- Show that  $\mathbf{V}(I_1 + \dots + I_l) = \bigcap_{i=1}^l V_i$ .
  - Show that  $\mathbf{V}(I_1 \cap \dots \cap I_l) = \mathbf{V}(I_1 \cdots I_l) = \bigcup_{i=1}^l V_i$ .
8. Let  $f_1, \dots, f_s$  be homogeneous polynomials of total degrees  $d_1 < d_2 \leq \dots \leq d_s$  and let  $I = \langle f_1, \dots, f_s \rangle \subset k[x_0, \dots, x_n]$ .
- Show that if  $g$  is another homogeneous polynomial of degree  $d_1$  in  $I$ , then  $g$  must be a constant multiple of  $f_1$ . Hint: Use parts (a) and (b) of Exercise 2.
  - More generally, show that if the total degree of  $g$  is  $d$ , then  $g$  must be an element of the ideal  $I_d = \langle f_i : \deg(f_i) \leq d \rangle \subset I$ .
9. This exercise will study some properties of the ideal  $I_0 = \langle x_0, \dots, x_n \rangle \subset k[x_0, \dots, x_n]$ .
- Show that every proper homogeneous ideal in  $k[x_0, \dots, x_n]$  is contained in  $I_0$ .
  - Show that the  $r$ -th power  $I_0^r$  is the ideal generated by the collection of monomials in  $k[x_0, \dots, x_n]$  of total degree exactly  $r$  and deduce that every homogeneous polynomial of degree  $\geq r$  is in  $I_0^r$ .
  - Let  $V = \mathbf{V}(I_0) \subset \mathbb{P}^n(k)$  and  $C_V = \mathbf{V}_a(I_0) \subset k^{n+1}$ . Show that  $\mathbf{I}_a(C_V) \neq \mathbf{I}(V)$ , and explain why this does not contradict equation (2) in the text.
10. Given a homogeneous ideal  $I \subset k[x_0, \dots, x_n]$ , where  $k$  is algebraically closed, prove that  $\mathbf{V}(I) = \emptyset$  in  $\mathbb{P}^n(k)$  is equivalent to either of the following two conditions:
- There is an  $r \geq 1$  such that every homogeneous polynomial of total degree  $\geq r$  is contained in  $I$ .
  - The radical of  $I$  is either  $\langle x_0, \dots, x_n \rangle$  or  $k[x_0, \dots, x_n]$ .
- Hint: For (i), use Exercise 9, and for (ii), use the proof of Theorem 8 to show that  $\langle x_0, \dots, x_n \rangle \subset \sqrt{I}$ .
11. A homogeneous ideal is said to be *prime* if it is prime as an ideal in  $k[x_0, \dots, x_n]$ .
- Show that a homogeneous ideal  $I \subset k[x_0, \dots, x_n]$  is prime if and only if whenever the product of two *homogeneous* polynomials  $F, G$  satisfies  $F \cdot G \in I$ , then  $F \in I$  or  $G \in I$ .
  - Let  $k$  be algebraically closed. Let  $I$  be a homogeneous ideal. Show that the projective variety  $\mathbf{V}(I)$  is irreducible if  $I$  is prime. Also, when  $I$  is radical, prove that the converse holds, i.e., that  $I$  is prime if  $\mathbf{V}(I)$  is irreducible. Hint: Consider the proof of the corresponding statement in the affine case (Proposition 3 of Chapter 4, §5).
  - Let  $k$  be algebraically closed. Show that the mappings  $\mathbf{V}$  and  $\mathbf{I}$  induce one-to-one correspondence between homogeneous prime ideals in  $k[x_0, \dots, x_n]$  properly contained in  $\langle x_0, \dots, x_n \rangle$  and nonempty irreducible projective varieties in  $\mathbb{P}^n(k)$ .
12. Prove that a homogeneous prime ideal is a radical ideal in  $k[x_0, \dots, x_n]$ .

## §4 The Projective Closure of an Affine Variety

In §2, we showed that any affine variety could be regarded as the affine portion of a projective variety. Since this can be done in more than one way (see Example 9 of §2),

we would like to find the *smallest* projective variety containing a given affine variety. As we will see, there is an algorithmic way to do this.

Given homogeneous coordinates  $x_0, \dots, x_n$  on  $\mathbb{P}^n(k)$ , we have the subset  $U_0 \subset \mathbb{P}^n(k)$  defined by  $x_0 \neq 0$ . If we identify  $U_0$  with  $k^n$  using Proposition 2 of §2, then we get coordinates  $x_1, \dots, x_n$  on  $k^n$ . As in §3, we will use  $\mathbf{I}_a$  and  $\mathbf{V}_a$  for the affine versions of  $\mathbf{I}$  and  $\mathbf{V}$ .

We first discuss how to homogenize an ideal of  $k[x_1, \dots, x_n]$ . Given  $I \subset k[x_1, \dots, x_n]$ , the standard way to produce a homogeneous ideal  $I^h \subset k[x_0, \dots, x_n]$  is as follows.

**Definition 1.** Let  $I$  be an ideal in  $k[x_1, \dots, x_n]$ . We define the **homogenization of  $I$**  to be the ideal

$$I^h = \langle f^h : f \in I \rangle \subset k[x_0, \dots, x_n],$$

where  $f^h$  is the homogenization of  $f$  as in Proposition 7 of §2.

Naturally enough, we have the following result.

**Proposition 2.** For any ideal  $I \subset k[x_1, \dots, x_n]$ , the homogenization  $I^h$  is a homogeneous ideal in  $k[x_0, \dots, x_n]$ .

**Proof.** See Exercise 1. □

Definition 1 is not entirely satisfying as it stands because it does not give us a *finite* generating set for the ideal  $I^h$ . There is a subtle point here. Given a particular finite generating set  $f_1, \dots, f_s$  for  $I \subset k[x_1, \dots, x_n]$ , it is always true that  $\langle f_1^h, \dots, f_s^h \rangle$  is a homogeneous ideal contained in  $I^h$ . However, as the following example shows,  $I^h$  can be *strictly larger* than  $\langle f_1^h, \dots, f_s^h \rangle$ .

**Example 3.** Consider  $I = \langle f_1, f_2 \rangle = \langle x_2 - x_1^2, x_3 - x_1^3 \rangle$ , the ideal of the affine twisted cubic in  $\mathbb{R}^3$ . If we homogenize  $f_1, f_2$ , then we get the ideal  $J = \langle x_2x_0 - x_1^2, x_3x_0^2 - x_1^3 \rangle$  in  $\mathbb{R}[x_0, x_1, x_2, x_3]$ . We claim that  $J \neq I^h$ . To prove this, consider the polynomial

$$f_3 = f_2 - x_1f_1 = x_3 - x_1^3 - x_1(x_2 - x_1^2) = x_3 - x_1x_2 \in I.$$

Then  $f_3^h = x_0x_3 - x_1x_2$  is a homogeneous polynomial of degree 2 in  $I^h$ . Since the generators of  $J$  are also homogeneous, of degrees 2 and 3, respectively, if we had an equation  $f_3^h = A_1f_1^h + A_2f_2^h$ , then using the expansions of  $A_1$  and  $A_2$  into homogeneous components, we would see that  $f_3^h$  was a constant multiple of  $f_1^h$ . (See Exercise 8 of §3 for a general statement along these lines.) Since this is clearly false, we have  $f_3^h \notin J$ , and thus,  $J \neq I^h$ .

Hence, we may ask whether there is some reasonable method for computing a finite generating set for the ideal  $I^h$ . The answer is given in the following theorem. A *graded*

monomial order in  $k[x_1, \dots, x_n]$  is one that orders first by total degree:

$$x^\alpha > x^\beta$$

whenever  $|\alpha| > |\beta|$ . Note that grlex and grevlex are graded orders, whereas lex is not.

**Theorem 4.** *Let  $I$  be an ideal in  $k[x_1, \dots, x_n]$  and let  $G = \{g_1, \dots, g_t\}$  be a Groebner basis for  $I$  with respect to a graded monomial order in  $k[x_1, \dots, x_n]$ . Then  $G^h = \{g_1^h, \dots, g_t^h\}$  is a basis for  $I^h \subset k[x_0, \dots, x_n]$ .*

**Proof.** We will prove the theorem by showing the stronger statement that  $G^h$  is actually a Groebner basis for  $I^h$  with respect to an appropriate monomial order in  $k[x_0, \dots, x_n]$ .

Every monomial in  $k[x_0, \dots, x_n]$  can be written

$$x_1^{\alpha_1} \dots x_n^{\alpha_n} x_0^d = x^\alpha x_0^d,$$

where  $x^\alpha$  contains no  $x_0$  factors. Then we can extend the graded order  $>$  on monomials in  $k[x_1, \dots, x_n]$  to a monomial order  $>_h$  in  $k[x_0, \dots, x_n]$  as follows:

$$x^\alpha x_0^d >_h x^\beta x_0^e \iff x^\alpha > x^\beta \quad \text{or} \quad x^\alpha = x^\beta \quad \text{and} \quad d > e.$$

In Exercise 2, you will show that this defines a monomial order in  $k[x_0, \dots, x_n]$ . Note that under this ordering, we have  $x_i >_h x_0$  for all  $i \geq 1$ .

For us, the most important property of the order  $>_h$  is given in the following lemma.

**Lemma 5.** *If  $f \in k[x_1, \dots, x_n]$  and  $>$  is a graded order on  $k[x_1, \dots, x_n]$ , then*

$$\text{LM}_{>_h}(f^h) = \text{LM}_>(f).$$

**Proof of Lemma.** Since  $>$  is a graded order, for any  $f \in k[x_1, \dots, x_n]$ ,  $\text{LM}_>(f)$  is one of the monomials  $x^\alpha$  appearing in the homogeneous component of  $f$  of maximal total degree. When we homogenize, this term is unchanged. If  $x^\beta x_0^e$  is any one of the other monomials appearing in  $f^h$ , then  $\alpha > \beta$ . By the definition of  $>_h$ , it follows that  $x^\alpha >_h x^\beta x_0^e$ . Hence,  $x^\alpha = \text{LM}_{>_h}(f^h)$ , and the lemma is proved.  $\square$

We will now show that  $G^h$  forms a Groebner basis for the ideal  $I^h$  with respect to the monomial order  $>_h$ . Each  $g_i^h \in I^h$  by definition. Thus, it suffices to show that the ideal of leading terms  $\langle \text{LT}_{>_h}(I^h) \rangle$  is generated by  $\text{LT}_{>_h}(G^h)$ . To prove this, consider  $F \in I^h$ . Since  $I^h$  is a homogeneous ideal, each homogeneous component of  $F$  is in  $I^h$  and, hence, we may assume that  $F$  is homogeneous. Because  $F \in I^h$ , by definition we have

$$(1) \quad F = \sum_j A_j f_j^h,$$

where  $A_j \in k[x_0, \dots, x_n]$  and  $f_j \in I$ . We will let  $f = F(1, x_1, \dots, x_n)$  denote the dehomogenization of  $F$ . Then setting  $x_0 = 1$  in (1) yields

$$\begin{aligned} f &= F(1, x_1, \dots, x_n) = \sum_j A_j(1, x_1, \dots, x_n) f_j^h(1, x_1, \dots, x_n) \\ &= \sum_j A_j(1, x_1, \dots, x_n) f_j \end{aligned}$$

since  $f_j^h(1, x_1, \dots, x_n) = f_j(x_1, \dots, x_n)$  by part (iii) of Proposition 7 from §2. This shows that  $f \in I \subset k[x_1, \dots, x_n]$ . If we homogenize  $f$ , then part (iv) of Proposition 7 in §2 implies that

$$F = x_0^e \cdot f^h$$

for some  $e \geq 0$ . Thus,

$$(2) \quad \text{LM}_{>_h}(F) = x_0^e \cdot \text{LM}_{>_h}(f^h) = x_0^e \cdot \text{LM}_{>}(f),$$

where the last equality is by Lemma 5. Since  $G$  is a Groebner basis for  $I$ , we know that  $\text{LM}_{>}(f)$  is divisible by some  $\text{LM}_{>}(g_i) = \text{LM}_{>_h}(g_i^h)$  (using Lemma 5 again). Then (2) shows that  $\text{LM}_{>_h}(F)$  is divisible by  $\text{LM}_{>_h}(g_i^h)$ , as desired. This completes the proof of the theorem.  $\square$

In Exercise 5, you will see that there is a more elegant formulation of Theorem 4 for the special case of grevlex order.

To illustrate the theorem, consider the ideal  $I = \langle x_2 - x_1^2, x_3 - x_1^3 \rangle$  of the affine twisted cubic  $W \subset \mathbb{R}^3$  once again. Computing a Groebner basis for  $I$  with respect to grevlex order, we find

$$G = \left\{ x_1^2 - x_2, x_1x_2 - x_3, x_1x_3 - x_2^2 \right\}.$$

By Theorem 4, the homogenizations of these polynomials generate  $I^h$ . Thus,

$$(3) \quad I^h = \left\langle x_1^2 - x_0x_2, x_1x_2 - x_0x_3, x_1x_3 - x_2^2 \right\rangle.$$

Note that this ideal gives us the projective variety  $V' = \mathbf{V}(I^h) \subset \mathbb{P}^3(\mathbb{R})$  which we discovered in Example 9 of §2.

For the remainder of this section, we will discuss the geometric meaning of the homogenization of an ideal. We will begin by studying what happens when we homogenize the ideal  $\mathbf{I}_a(W)$  of all polynomials vanishing on an affine variety  $W$ . This leads to the following definition.

**Definition 6.** Given an affine variety  $W \subset k^n$ , the **projective closure** of  $W$  is the projective variety  $\overline{W} = \mathbf{V}(\mathbf{I}_a(W)^h) \subset \mathbb{P}^n(k)$ , where  $\mathbf{I}_a(W)^h \subset k[x_0, \dots, x_n]$  is the homogenization of the ideal  $\mathbf{I}_a(W) \subset k[x_1, \dots, x_n]$  as in Definition 1.

The projective closure has the following important properties.

**Proposition 7.** Let  $W \subset k^n$  be an affine variety and let  $\overline{W} \subset \mathbb{P}^n(k)$  be its projective closure. Then:

- (i)  $\overline{W} \cap U_0 = \overline{W} \cap k^n = W$ .
- (ii)  $\overline{W}$  is the smallest projective variety in  $\mathbb{P}^n(k)$  containing  $W$ .
- (iii) If  $W$  is irreducible, then so is  $\overline{W}$ .
- (iv) No irreducible component of  $\overline{W}$  lies in the hyperplane at infinity  $\mathbf{V}(x_0) \subset \mathbb{P}^n(k)$ .

**Proof.** (i) Let  $G$  be a Groebner basis of  $\mathbf{I}_a(W)$  with respect to a graded order on  $k[x_1, \dots, x_n]$ . Then Theorem 4 implies that  $\mathbf{I}_a(W)^h = \langle g^h : g \in G \rangle$ . We know that

$k^n \cong U_0$  is the subset of  $\mathbb{P}^n(k)$ , where  $x_0 = 1$ . Thus, we have

$$\overline{W} \cap U_0 = \mathbf{V}(g^h : g \in G) \cap U_0 = \mathbf{V}_a(g^h(1, x_1, \dots, x_n) : g \in G).$$

Since  $g^h(1, x_1, \dots, x_n) = g$  by part (iii) of Proposition 7 from §2, we get  $\overline{W} \cap U_0 = W$ .

(ii) We need to prove that if  $V$  is a projective variety containing  $W$ , then  $\overline{W} \subset V$ . Suppose that  $V = \mathbf{V}(F_1, \dots, F_s)$ . Then  $F_i$  vanishes on  $V$ , so that its dehomogenization  $f_i = F_i(1, x_1, \dots, x_n)$  vanishes on  $W$ . Thus,  $f_i \in \mathbf{I}_a(W)$  and, hence,  $f_i^h \in \mathbf{I}_a(W)^h$ . This shows that  $f_i^h$  vanishes on  $\overline{W} = \mathbf{V}(\mathbf{I}_a(W)^h)$ . But part (iv) of Proposition 7 from §2 implies that  $F_i = x_0^{e_i} f_i^h$  for some integer  $e_i$ . Thus,  $F_i$  vanishes on  $\overline{W}$ , and since this is true for all  $i$ , it follows that  $\overline{W} \subset V$ .

The proof of (iii) will be left as an exercise. To prove (iv), let  $\overline{W} = V_1 \cup \dots \cup V_m$  be the decomposition of  $\overline{W}$  into irreducible components. Suppose that one of them,  $V_1$ , was contained in the hyperplane at infinity  $\mathbf{V}(x_0)$ . Then

$$\begin{aligned} W = \overline{W} \cap U_0 &= (V_1 \cup \dots \cup V_m) \cap U_0 \\ &= (V_1 \cap U_0) \cup ((V_2 \cup \dots \cup V_m) \cap U_0) \\ &= (V_2 \cup \dots \cup V_m) \cap U_0. \end{aligned}$$

This shows that  $V_2 \cup \dots \cup V_m$  is a projective variety containing  $W$ . By the minimality of  $\overline{W}$ , it follows that  $\overline{W} = V_2 \cup \dots \cup V_m$  and, hence,  $V_1 \subset V_2 \cup \dots \cup V_m$ . We will leave it as an exercise to show that this is impossible since  $V_1$  is an irreducible component of  $\overline{W}$ . This contradiction completes the proof.  $\square$

For an example of how the projective closure works, consider the affine twisted cubic  $W \subset \mathbb{R}^3$ . In §4 of Chapter 1, we proved that

$$\mathbf{I}_a(W) = \langle x_2 - x_1^2, x_3 - x_1^3 \rangle.$$

Using Theorem 4, we proved in (3) that

$$\mathbf{I}_a(W)^h = \langle x_1^2 - x_0x_2, x_1x_2 - x_0x_3, x_1x_3 - x_2^2 \rangle.$$

It follows that the variety  $V' = \mathbf{V}(x_1^2 - x_0x_2, x_1x_2 - x_0x_3, x_1x_3 - x_2^2)$  discussed in Example 9 of §2 is the projective closure of the affine twisted cubic.

The main drawback of the definition of projective closure is that it requires that we know  $\mathbf{I}_a(W)$ . It would be much more convenient if we could compute the projective closure directly from *any* defining ideal of  $W$ . When the field  $k$  is algebraically closed, this can always be done.

**Theorem 8.** *Let  $k$  be an algebraically closed field, and let  $I \subset k[x_1, \dots, x_n]$  be an ideal. Then  $\mathbf{V}(I^h) \subset \mathbb{P}^n(k)$  is the projective closure of  $\mathbf{V}_a(I) \subset k^n$ .*

**Proof.** Let  $W = \mathbf{V}_a(I) \subset k^n$  and  $Z = \mathbf{V}(I^h) \subset \mathbb{P}^n(k)$ . The proof of part (i) of Proposition 7 shows that  $Z$  is a projective variety containing  $W$ .

To prove that  $Z$  is the smallest such variety, we proceed as in part (ii) of Proposition 7. Thus, let  $V = \mathbf{V}(F_1, \dots, F_s)$  be any projective variety containing  $W$ . As in the earlier argument, the dehomogenization  $f_i = F_i(1, x_1, \dots, x_n)$  is in  $\mathbf{I}_a(W)$ . Since  $k$  is

algebraically closed, the Nullstellensatz implies that  $\mathbf{I}_a(W) = \sqrt{I}$ , so that  $f_i^m \in I$  for some integer  $m$ . This tells us that

$$(f_i^m)^h \in I^h$$

and, consequently,  $(f_i^m)^h$  vanishes on  $Z$ . In the exercises, you will show that

$$(f_i^m)^h = (f_i^h)^m,$$

and it follows that  $f_i^h$  vanishes on  $Z$ . Then  $F_i = x_0^{e_i} f_i^h$  shows that  $F_i$  is also zero on  $Z$ . As in Proposition 7, we conclude that  $Z \subset V$ .

This shows that  $Z$  is the smallest projective variety containing  $W$ . Since the projective closure  $\overline{W}$  has the same property by Proposition 7, we see that  $Z = \overline{W}$ .  $\square$

If we combine Theorems 4 and 8, we get an **algorithm for computing the projective closure of an affine variety** over an algebraically closed field  $k$ : given  $W \subset k^n$  defined by  $f_1 = \cdots = f_s = 0$ , compute a Groebner basis  $G$  of  $\langle f_1, \dots, f_s \rangle$  with respect to a graded order, and then the projective closure in  $\mathbb{P}^n(k)$  is defined by  $g^h = 0$  for  $g \in G$ .

Unfortunately, Theorem 8 can fail over fields that are not algebraically closed. Here is an example that shows what can go wrong.

**Example 9.** Consider  $I = \langle x_1^2 + x_2^4 \rangle \subset \mathbb{R}[x_1, x_2]$ . Then  $W = \mathbf{V}_a(I)$  consists of the single point  $(0, 0)$  in  $\mathbb{R}^2$ , and hence, the projective closure is the single point  $\overline{W} = \{(1, 0, 0)\} \subset \mathbb{P}^2(\mathbb{R})$  (since this is obviously the smallest projective variety containing  $W$ ). On the other hand,  $I^h = \langle x_1^2 x_0^2 + x_2^4 \rangle$ , and it is easy to check that

$$\mathbf{V}(I^h) = \{(1, 0, 0), (0, 1, 0)\} \subset \mathbb{P}^2(\mathbb{R}).$$

This shows that  $\mathbf{V}(I^h)$  is strictly larger than the projective closure of  $W = \mathbf{V}_a(I)$ .

### EXERCISES FOR §4

1. Prove Proposition 2.
2. Show that the order  $>_h$  defined in the proof of Theorem 4 is a monomial order on  $k[x_0, \dots, x_n]$ . Hint: This can be done directly or by using the mixed orders defined in Exercise 10 of Chapter 2, §4.
3. Show by example that the conclusion of Theorem 4 is *not true* if we use an arbitrary monomial order in  $k[x_1, \dots, x_n]$  and homogenize a Groebner basis with respect to that order. Hint: One example can be obtained using the ideal of the affine twisted cubic and computing a Groebner basis with respect to a nongraded order.
4. Let  $>$  be a graded monomial order on  $k[x_1, \dots, x_n]$  and let  $>_h$  be the order defined in the proof of Theorem 4. In the proof of the theorem, we showed that if  $G$  is a Groebner basis for  $I \subset k[x_1, \dots, x_n]$  with respect to  $>$ , then  $G^h$  was a Groebner basis for  $I^h$  with respect to  $>_h$ . In this exercise, we will explore other monomial orders on  $k[x_0, \dots, x_n]$  that have this property.
  - a. Define a graded version of  $>_h$  by setting

$$x^\alpha x_0^d >_{gh} x^\beta x_0^e \iff |\alpha| + d > |\beta| + e \quad \text{or} \quad |\alpha| + d = |\beta| + e \\ \text{and } x^\alpha x_0^d >_h x^\beta x_0^e.$$

Show that  $G^h$  is a Groebner basis with respect to  $>_{gh}$ .



- b. More generally, let  $>'$  be any monomial order on  $k[x_0, \dots, x_n]$  which extends  $>$  and which has the property that among monomials of the same total degree, any monomial containing  $x_0$  is smaller than all monomials containing only  $x_1, \dots, x_n$ . Show that  $G^h$  is a Groebner basis for  $>'$ .
5. Let  $>$  denote grevlex order in the ring  $S = k[x_1, \dots, x_n, x_{n+1}]$ . Consider  $R = k[x_1, \dots, x_n] \subset S$ . For  $f \in R$ , let  $f^h$  denote the homogenization of  $f$  with respect to the variable  $x_{n+1}$ .
- a. Show that if  $f \in R \subset S$  (that is,  $f$  depends only on  $x_1, \dots, x_n$ ), then  $\text{LT}_{>}(f) = \text{LT}_{>}(f^h)$ .
- b. Use part (a) to show that if  $G$  is a Groebner basis for an ideal  $I \subset R$  with respect to grevlex, then  $G^h$  is a Groebner basis for the ideal  $I^h$  in  $S$  with respect to grevlex.
6. Prove that the homogenization has the following properties for polynomials  $f, g \in k[x_1, \dots, x_n]$ :

$$(fg)^h = f^h g^h,$$

$$(f^m)^h = (f^h)^m \quad \text{for any integer } m \geq 0.$$

Hint: Use the formula for homogenization given by part (ii) of Proposition 7 from §2.

7. Show that  $I \subset k[x_1, \dots, x_n]$  is a prime ideal if and only if  $I^h$  is a prime ideal in  $k[x_0, \dots, x_n]$ . Hint: For the  $\Rightarrow$  implication, use part (a) of Exercise 11 of §3; for the converse implication, use Exercise 6.
8. Adapt the proof of part (ii) of Proposition 7 to show that  $\mathbf{I}(\overline{W}) = \mathbf{I}_a(W)^h$  for any affine variety  $W \subset k^n$ .
9. Prove that an affine variety  $W$  is irreducible if and only if its projective closure  $\overline{W}$  is irreducible.
10. Let  $W = V_1 \cup \dots \cup V_m$  be the decomposition of a projective variety into its irreducible components such that  $V_i \not\subset V_j$  for  $i \neq j$ . Prove that  $V_1 \not\subset V_2 \cup \dots \cup V_m$ .

In Exercises 11–14, we will explore some interesting varieties in projective space. For ease of notation, we will write  $\mathbb{P}^n$  rather than  $\mathbb{P}^n(k)$ . We will also assume that  $k$  is algebraically closed so that we can apply Theorem 8.

11. The twisted cubic that we have used repeatedly for examples is one member of an infinite family of curves known as the *rational normal curves*. The rational normal curve in  $k^n$  is the image of the polynomial parametrization  $\phi : k \rightarrow k^n$  given by

$$\phi(t) = (t, t^2, t^3, \dots, t^n).$$

By our general results on implicitization from Chapter 3, we know the rational normal curves are affine varieties. Their projective closures in  $\mathbb{P}^n$  are also known as rational normal curves.

- a. Find affine equations for the rational normal curves in  $k^4$  and  $k^5$ .
- b. Homogenize your equations from part (a) and consider the projective varieties defined by these homogeneous polynomials. Do your equations define the projective closure of the affine curve? Are there any “extra” components at infinity?
- c. Using Theorems 4 and 8, find a set of homogeneous equations defining the projective closures of these rational normal curves in  $\mathbb{P}^4$  and  $\mathbb{P}^5$ , respectively. Do you see a pattern?
- d. Show that the rational normal curve in  $\mathbb{P}^n$  is the variety defined by the set of homogeneous quadrics obtained by taking all possible  $2 \times 2$  subdeterminants of the  $2 \times n$  matrix:

$$\begin{pmatrix} x_0 & x_1 & x_2 & \cdots & x_{n-1} \\ x_1 & x_2 & x_3 & \cdots & x_n \end{pmatrix}.$$

12. The affine Veronese surface  $S \subset k^5$  was introduced in Exercise 6 of Chapter 5, §1. It is the image of the polynomial parametrization  $\phi : k^2 \rightarrow k^5$  given by

$$\phi(x_1, x_2) = (x_1, x_2, x_1^2, x_1x_2, x_2^2).$$

The projective closure of  $S$  is a projective variety known as the *projective Veronese surface*.

- a. Find a set of homogeneous equations for the projective Veronese surface in  $\mathbb{P}^5$ .
  - b. Show that the parametrization of the affine Veronese surface above can be extended to a mapping from  $\tilde{\phi} : \mathbb{P}^2 \rightarrow \mathbb{P}^5$  whose image coincides with the entire projective Veronese surface. Hint: You must show that  $\tilde{\phi}$  is well-defined (i.e., that it yields the same point in  $\mathbb{P}^5$  for any choice of homogeneous coordinates for a point in  $\mathbb{P}^2$ ).
13. The Cartesian product of two affine spaces is simply another affine space:  $k^n \times k^m = k^{m+n}$ . If we use the standard inclusions  $k^n \subset \mathbb{P}^n, k^m \subset \mathbb{P}^m$ , and  $k^{n+m} \subset \mathbb{P}^{n+m}$  given by Proposition 2 of §2, how is  $\mathbb{P}^{n+m}$  different from  $\mathbb{P}^n \times \mathbb{P}^m$  (as a set)?
14. In this exercise, we will see that  $\mathbb{P}^n \times \mathbb{P}^m$  can be identified with a certain projective variety in  $\mathbb{P}^{n+m+nm}$  known as a *Segre variety*. The idea is as follows. Let  $p = (x_0, \dots, x_n)$  be homogeneous coordinates of  $p \in \mathbb{P}^n$  and let  $q = (y_0, \dots, y_m)$  be homogeneous coordinates of  $q \in \mathbb{P}^m$ . The Segre mapping  $\sigma : \mathbb{P}^n \times \mathbb{P}^m \rightarrow \mathbb{P}^{n+m+nm}$  is defined by taking the pair  $(p, q) \in \mathbb{P}^n \times \mathbb{P}^m$  to the point in  $\mathbb{P}^{n+m+nm}$  with homogeneous coordinates

$$(x_0y_0, x_0y_1, \dots, x_0y_m, x_1y_0, \dots, x_1y_m, \dots, x_ny_0, \dots, x_ny_m).$$

The components are all the possible products  $x_iy_j$  where  $0 \leq i \leq n$  and  $0 \leq j \leq m$ . The image is a projective variety called a Segre variety.

- a. Show that  $\sigma$  is a well-defined mapping. (That is, show that we obtain the same point in  $\mathbb{P}^{n+m+nm}$  no matter what homogeneous coordinates for  $p, q$  we use.)
- b. Show that  $\sigma$  is a one-to-one mapping and that the “affine part”  $k^n \times k^m$  maps to an affine variety in  $k^{n+m+nm} = U_0 \subset \mathbb{P}^{n+m+nm}$  that is *isomorphic* to  $k^{n+m}$ . (See Chapter 5, §4.)
- c. Taking  $n = m = 1$  above, write out  $\sigma : \mathbb{P}^1 \times \mathbb{P}^1 \rightarrow \mathbb{P}^3$  explicitly and find homogeneous equation(s) for the image. Hint: You should obtain a single quadratic equation. This Segre variety is a quadric surface in  $\mathbb{P}^3$ .
- d. Now consider the case  $n = 2, m = 1$  and find homogeneous equations for the Segre variety in  $\mathbb{P}^5$ .
- e. What is the intersection of the Segre variety in  $\mathbb{P}^5$  and the Veronese surface in  $\mathbb{P}^5$ ? (See Exercise 12.)

## §5 Projective Elimination Theory

In Chapter 3, we encountered numerous instances of “missing points” when studying the geometric interpretation of elimination theory. Since our original motivation for projective space was to account for “missing points,” it makes sense to look back at elimination theory using what we know about  $\mathbb{P}^n(k)$ . You may want to review the first two sections of Chapter 3 before reading further.

We begin with the following example.

**Example 1.** Consider the variety  $V \subset \mathbb{C}^2$  defined by the equation

$$xy^2 = x - 1.$$

To eliminate  $x$ , we use the elimination ideal  $I_1 = \langle xy^2 - x + 1 \rangle \cap \mathbb{C}[y]$ , and it is easy to show that  $I_1 = \{0\} \subset \mathbb{C}[y]$ . In Chapter 3, we observed that eliminating  $x$  corresponds geometrically to the projection  $\pi(V) \subset \mathbb{C}$ , where  $\pi : \mathbb{C}^2 \rightarrow \mathbb{C}$  is defined by  $\pi(x, y) = y$ . We know that  $\pi(V) \subset \mathbf{V}(I_1) = \mathbb{C}$ , but as the following picture shows,  $\pi(V)$  does not fill up all of  $\mathbf{V}(I_1)$ :

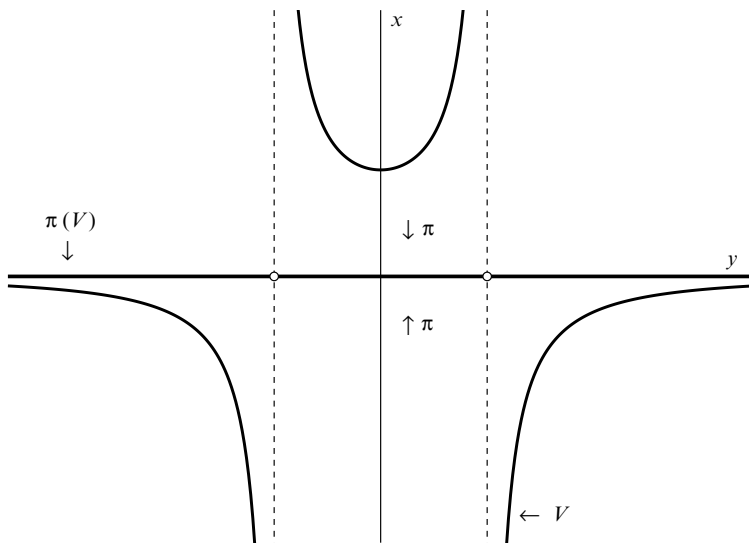

We can control the missing points using the Geometric Extension Theorem (Theorem 2 of Chapter 3, §2). Recall how this works: if we write the defining equation of  $V$  as  $(y^2 - 1)x + 1 = 0$ , then the Extension Theorem guarantees that we can solve for  $x$  whenever the leading coefficient of  $x$  does not vanish. Thus,  $y = \pm 1$  are the only missing points.

To reinterpret the Geometric Extension Theorem in terms of projective space, first observe that the standard projective plane  $\mathbb{P}^2(\mathbb{C})$  is not quite what we want. We are really only interested in directions along the projection (i.e., parallel to the  $x$ -axis) since all of our missing points lie in this direction. So we do not need all of  $\mathbb{P}^2(\mathbb{C})$ . A more serious problem is that in  $\mathbb{P}^2(\mathbb{C})$ , all lines parallel to the  $x$ -axis correspond to a *single* point at infinity, yet we are missing *two* points.

To avoid this difficulty, we will use something besides  $\mathbb{P}^2(\mathbb{C})$ . If we write  $\pi$  as  $\pi : \mathbb{C} \times \mathbb{C} \rightarrow \mathbb{C}$ , the idea is to make the first factor projective rather than the whole thing. This gives us  $\mathbb{P}^1(\mathbb{C}) \times \mathbb{C}$ , and we will again use  $\pi$  to denote the projection  $\pi : \mathbb{P}^1(\mathbb{C}) \times \mathbb{C} \rightarrow \mathbb{C}$  onto the second factor.

We will use coordinates  $(t, x, y)$  on  $\mathbb{P}^1(\mathbb{C}) \times \mathbb{C}$ , where  $(t, x)$  are homogeneous coordinates on  $\mathbb{P}^1(\mathbb{C})$  and  $y$  is the usual coordinate on  $\mathbb{C}$ . Thus, (in analogy with Proposition 2 of §2) a point  $(1, x, y) \in \mathbb{P}^1(\mathbb{C}) \times \mathbb{C}$  corresponds to  $(x, y) \in \mathbb{C} \times \mathbb{C}$ . We will regard  $\mathbb{C} \times \mathbb{C}$  as a subset of  $\mathbb{P}^1(\mathbb{C}) \times \mathbb{C}$  and you should check that the complement consists of the “points at infinity”  $(0, 1, y)$ .

We can extend  $V \subset \mathbb{C} \times \mathbb{C}$  to  $\bar{V} \subset \mathbb{P}^1(\mathbb{C}) \times \mathbb{C}$  by making the equation of  $V$  homogeneous with respect to  $t$  and  $x$ . Thus,  $\bar{V}$  is defined by

$$xy^2 = x - t.$$

In Exercise 1, you will check that this equation is well-defined on  $\mathbb{P}^1(\mathbb{C}) \times \mathbb{C}$ . To find the solutions of this equation, we first set  $t = 1$  to get the affine portion and then we set  $t = 0$  to find the points at infinity. This leads to

$$\bar{V} = V \cup \{(0, 1, \pm 1)\}$$

(remember that  $t$  and  $x$  cannot simultaneously vanish since they are homogeneous coordinates). Under the projection  $\pi : \mathbb{P}^1(\mathbb{C}) \times \mathbb{C} \rightarrow \mathbb{C}$ , it follows that  $\pi(\bar{V}) = \mathbb{C} = \mathbf{V}(I_1)$  because the two points at infinity map to the “missing points”  $y = \pm 1$ . As we will soon see, the equality  $\pi(\bar{V}) = \mathbf{V}(I_1)$  is a special case of the projective version of the Geometric Extension Theorem.

We will use the following general framework for generalizing the issues raised by Example 1. Suppose we have equations

$$\begin{aligned} f_1(x_1, \dots, x_n, y_1, \dots, y_m) &= 0, \\ &\vdots \\ f_s(x_1, \dots, x_n, y_1, \dots, y_m) &= 0, \end{aligned}$$

where  $f_1, \dots, f_s \in k[x_1, \dots, x_n, y_1, \dots, y_m]$ . Algebraically, we can eliminate  $x_1, \dots, x_n$  by computing the ideal  $I_n = \langle f_1, \dots, f_s \rangle \cap k[y_1, \dots, y_m]$  (the Elimination Theorem from Chapter 3, §1 tells us how to do this). If we think geometrically, the above equations define a variety  $V \subset k^n \times k^m$ , and eliminating  $x_1, \dots, x_n$  corresponds to considering  $\pi(V)$ , where  $\pi : k^n \times k^m \rightarrow k^m$  is projection onto the last  $m$  coordinates. Our goal is to describe the relation between  $\pi(V)$  and  $\mathbf{V}(I_n)$ .

The basic idea is to make the first factor projective. To simplify notation, we will write  $\mathbb{P}^n(k)$  as  $\mathbb{P}^n$  when there is no confusion about what field we are dealing with. A point in  $\mathbb{P}^n \times k^m$  will have coordinates  $(x_0, \dots, x_n, y_1, \dots, y_m)$ , where  $(x_0, \dots, x_n)$  are homogeneous coordinates in  $\mathbb{P}^n$  and  $(y_1, \dots, y_m)$  are usual coordinates in  $k^m$ . Thus,  $(1, 1, 1, 1)$  and  $(2, 2, 1, 1)$  are coordinates for the same point in  $\mathbb{P}^1 \times k^2$ , whereas  $(2, 2, 2, 2)$  gives a different point. As in Proposition 2 of §2, we will use the map

$$(x_1, \dots, x_n, y_1, \dots, y_m) \mapsto (1, x_1, \dots, x_n, y_1, \dots, y_m)$$

to identify  $k^n \times k^m$  with the subset of  $\mathbb{P}^n \times k^m$  where  $x_0 \neq 0$ .

We can define varieties in  $\mathbb{P}^n \times k^m$  using “partially” homogeneous polynomials as follows.

**Definition 2.** Let  $k$  be a field.

- (i) A polynomial  $F \in k[x_0, \dots, x_n, y_1, \dots, y_m]$  is  $(x_0, \dots, x_n)$ -homogeneous provided there is an integer  $l \geq 0$  such that

$$F = \sum_{|\alpha|=l} h_\alpha(y_1, \dots, y_m)x^\alpha,$$

where  $x^\alpha$  is a monomial in  $x_0, \dots, x_n$  of multidegree  $\alpha$  and  $h_\alpha \in k[y_1, \dots, y_m]$ .

(ii) The **variety**  $\mathbf{V}(F_1, \dots, F_s) \subset \mathbb{P}^n \times k^m$  defined by  $(x_0, \dots, x_n)$ -homogeneous polynomials  $F_1, \dots, F_s \in k[x_0, \dots, x_n, y_1, \dots, y_m]$  is the set

$$\{(a_0, \dots, a_n, b_1, \dots, b_m) \in \mathbb{P}^n \times k^m : F_i(a_0, \dots, a_n, b_1, \dots, b_m) = 0 \text{ for } 1 \leq i \leq s\}.$$

In the exercises, you will show that if a  $(x_0, \dots, x_n)$ -homogeneous polynomial vanishes at one set of coordinates for a point in  $\mathbb{P}^n \times k^m$ , then it vanishes for *all* coordinates of the point. This shows that the variety  $\mathbf{V}(F_1, \dots, F_s)$  is a well-defined subset of  $\mathbb{P}^n \times k^m$  when  $F_1, \dots, F_s$  are  $(x_0, \dots, x_n)$ -homogeneous.

We can now discuss what elimination theory means in this context. Suppose we have  $(x_0, \dots, x_n)$ -homogeneous equations

$$(1) \quad \begin{aligned} F_1(x_0, \dots, x_n, y_1, \dots, y_m) &= 0, \\ &\vdots \\ F_s(x_0, \dots, x_n, y_1, \dots, y_m) &= 0. \end{aligned}$$

These define the variety  $V = \mathbf{V}(F_1, \dots, F_s) \subset \mathbb{P}^n \times k^m$ . We also have the projection map

$$\pi : \mathbb{P}^n \times k^m \rightarrow k^m$$

onto the last  $m$  coordinates. Then we can interpret  $\pi(V) \subset k^m$  as the set of all  $m$ -tuples  $(y_1, \dots, y_m)$  for which the equations (1) have a *nontrivial* solution in  $x_0, \dots, x_n$  (which means that at least one  $x_i$  is nonzero).

To understand what this means algebraically, let us work out an example.

**Example 3.** In this example, we will use  $(u, v, y)$  as coordinates on  $\mathbb{P}^1 \times k$ . Then consider the equations

$$(2) \quad \begin{aligned} F_1 &= u + vy = 0, \\ F_2 &= u + uy = 0. \end{aligned}$$

Since  $(u, v)$  are homogeneous coordinates on  $\mathbb{P}^1$ , it is straightforward to show that

$$V = \mathbf{V}(F_1, F_2) = \{(0, 1, 0), (1, 1, -1)\}.$$

Under the projection  $\pi : \mathbb{P}^1 \times k \rightarrow k$ , we have  $\pi(V) = \{0, -1\}$ , so that for a given  $y$ , the equations (2) have a nontrivial solution if and only if  $y = 0$  or  $-1$ . Thus, (2) implies that  $y(1 + y) = 0$ .

Ideally, there should be a purely algebraic method of “eliminating”  $u$  and  $v$  from (2) to obtain  $y(1 + y) = 0$ . Unfortunately, the kind of elimination we did in Chapter 3 does not work. To see why, let  $I = \langle F_1, F_2 \rangle \subset k[u, v, y]$  be the ideal generated by  $F_1$  and  $F_2$ . Since every term of  $F_1$  and  $F_2$  contains  $u$  or  $v$ , it follows that

$$I \cap k[y] = \{0\}.$$

From the affine point of view, this is the correct answer since the *affine* variety

$$\mathbf{V}_a(F_1, F_2) \subset k^2 \times k$$

contains the trivial solutions  $(0, 0, y)$  for *all*  $y \in k$ . Thus, the affine methods of Chapter 3 will be useful only if we can find an algebraic way of excluding the solutions where  $u = v = 0$ .

We can shed some light on the matter by computing Groebner bases for  $I = \langle F_1, F_2 \rangle$  using various lex orders:

$$\begin{aligned} \text{using } u > v > y : I &= \langle u + vy, vy^2 + vy \rangle, \\ \text{using } v > u > y : I &= \langle vu - u^2, vy + u, u + uy \rangle. \end{aligned}$$

The last entries in each basis show that our desired answer  $y(1 + y)$  is *almost* in  $I$ , in the sense that

$$(3) \quad u \cdot y(1 + y), v \cdot y(1 + y) \in I.$$

In the language of ideal quotients from §4 of Chapter 4, this implies that

$$y(1 + y) \in I : \langle u, v \rangle.$$

Recall from Chapter 4 that for affine varieties, the ideal quotient corresponds (roughly) to the difference of varieties (see Theorem 7 of Chapter 4, §4 for a precise statement). Thus, the ideal  $I : \langle u, v \rangle$  is closely related to the difference

$$\mathbf{V}_a(F_1, F_2) - \mathbf{V}_a(u, v) \subset k^2 \times k.$$

This set consists *exactly* of the nontrivial solutions of (2). Hence, the ideal quotient enters in a natural way.

Thus, our goal of eliminating  $u$  and  $v$  projectively from (2) leads to the polynomial

$$y(1 + y) \in \tilde{I} = (I : \langle u, v \rangle) \cap k[y].$$

Using the techniques of Chapter 4, it can be shown that  $\tilde{I} = \langle y(1 + y) \rangle$  in this case.

With this example, we are very close to the definition of projective elimination. The only difference is that in general, higher powers of the variables may be needed in (3) (see Exercise 7 for an example). Hence, we get the following definition of the projective elimination ideal.

**Definition 4.** Given an ideal  $I \subset k[x_0, \dots, x_n, y_1, \dots, y_m]$  generated by  $(x_0, \dots, x_n)$ -homogeneous polynomials, the **projective elimination ideal** of  $I$  is the set

$$\hat{I} = \{f \in k[y_1, \dots, y_m] : \text{for each } 0 \leq i \leq n, \text{ there is } e_i \geq 0 \text{ with } x_i^{e_i} f \in I\}.$$

It is an easy exercise to show that  $\hat{I}$  is, in fact, an ideal of  $k[y_1, \dots, y_m]$ . To begin to see the role played by  $\hat{I}$ , we have the following result.

**Proposition 5.** Let  $V = \mathbf{V}(F_1, \dots, F_s) \subset \mathbb{P}^n \times k^m$  be a variety defined by  $(x_0, \dots, x_n)$ -homogeneous polynomials and let  $\pi : \mathbb{P}^n \times k^m \rightarrow k^m$  be the projection

map. Then in  $k^m$ , we have

$$\pi(V) \subset \mathbf{V}(\hat{I}),$$

where  $\hat{I}$  is the projective elimination ideal of  $I = \langle F_1, \dots, F_s \rangle$ .

**Proof.** Suppose that we have  $(a_0, \dots, a_n, b_1, \dots, b_m) \in V$  and  $f \in \hat{I}$ . Then  $x_i^{e_i} f(y_1, \dots, y_m) \in I$  implies that this polynomial vanishes on  $V$ , and hence,

$$a_i^{e_i} f(b_1, \dots, b_m) = 0$$

for all  $i$ . Since  $(a_0, \dots, a_n)$  are homogeneous coordinates, at least one  $a_i \neq 0$  and, thus,  $f(b_1, \dots, b_m) = 0$ . This proves that  $f$  vanishes on  $\pi(V)$  and the proposition follows.  $\square$

When the field is algebraically closed, we also have the following projective version of the Extension Theorem.

**Theorem 6 (The Projective Extension Theorem).** *Assume that  $k$  is algebraically closed and that  $V = \mathbf{V}(F_1, \dots, F_s) \subset \mathbb{P}^n \times k^m$  is defined by  $(x_0, \dots, x_n)$ -homogeneous polynomials in  $k[x_0, \dots, x_n, y_1, \dots, y_m]$ . Let  $I = \langle F_1, \dots, F_s \rangle$  and let  $\hat{I} \subset k[y_1, \dots, y_m]$  be the projective elimination ideal of  $I$ . If*

$$\pi : \mathbb{P}^n \times k^m \longrightarrow k^m$$

*is projection onto the last  $m$  coordinates, then*

$$\pi(V) = \mathbf{V}(\hat{I}).$$

**Proof.** The inclusion  $\pi(V) \subset \mathbf{V}(\hat{I})$  follows from Proposition 5. For the opposite inclusion, let  $\mathbf{c} = (c_1, \dots, c_m) \in \mathbf{V}(\hat{I})$  and set  $F_i(x_0, \dots, x_n, \mathbf{c}) = F_i(x_0, \dots, x_n, c_1, \dots, c_m)$ . This is a homogeneous polynomial in  $x_0, \dots, x_n$ , say of total degree  $= d_i$  [equal to the total degree of  $F_i(x_0, \dots, x_n, y_1, \dots, y_m)$  in  $x_0, \dots, x_n$ ].

If  $\mathbf{c} \notin \pi(V)$ , then it follows that the equations

$$F_1(x_0, \dots, x_n, \mathbf{c}) = \dots = F_s(x_0, \dots, x_n, \mathbf{c}) = 0$$

define the empty variety in  $\mathbb{P}^n$ . Since the field  $k$  is algebraically closed, the Projective Weak Nullstellensatz (Theorem 8 of §3) implies that for some  $r \geq 1$ , we have

$$\langle x_0, \dots, x_n \rangle^r \subset \langle F_1(x_0, \dots, x_n, \mathbf{c}), \dots, F_s(x_0, \dots, x_n, \mathbf{c}) \rangle.$$

This means that the monomials  $x^\alpha, |\alpha| = r$ , can be written as a polynomial linear combination of the  $F_i(x_0, \dots, x_n, \mathbf{c})$ , say

$$x^\alpha = \sum_{i=1}^s H_i(x_0, \dots, x_n) F_i(x_0, \dots, x_n, \mathbf{c}).$$

By taking homogeneous components, we can assume that each  $H_i$  is homogeneous of total degree  $r - d_i$  [since  $d_i$  is the total degree of  $F_i(x_0, \dots, x_n, \mathbf{c})$ ]. Then, writing

each  $H_i$  as a linear combination of monomials  $x^{\beta_i}$  with  $|\beta_i| = r - d_i$ , we see that the polynomials

$$x^{\beta_i} F_i(x_0, \dots, x_n, \mathbf{c}), i = 1, \dots, s, |\beta_i| = r - d_i$$

span the vector space of *all* homogeneous polynomials of total degree  $r$  in  $x_0, \dots, x_n$ . If the dimension of this space is denoted  $N_r$ , then by standard results in linear algebra, we can find  $N_r$  of these polynomials which form a basis for this space. We will denote this basis as

$$G_j(x_0, \dots, x_n, \mathbf{c}), j = 1, \dots, N_r.$$

To see why this leads to a contradiction, we will use linear algebra and the properties of determinants to create an interesting element of the elimination ideal  $\hat{I}$ . The polynomial  $G_j(x_0, \dots, x_n, \mathbf{c})$  comes from a polynomial  $G_j = G_j(x_0, \dots, x_n, y_1, \dots, y_m) \in k[x_0, \dots, x_n, y_1, \dots, y_m]$ . Each  $G_j$  is of the form  $x^{\beta_i} F_i$ , for some  $i$  and  $\beta_i$ , and is homogeneous in  $x_0, \dots, x_n$  of total degree  $r$ . Thus, we can write

$$(4) \quad G_j = \sum_{|\alpha|=r} a_{j\alpha}(y_1, \dots, y_m)x^\alpha.$$

Since the  $x^\alpha$  with  $|\alpha| = r$  form a basis of all homogeneous polynomials of total degree  $r$ , there are  $N_r$  such monomials. Hence we get a square matrix of polynomials  $a_{j\alpha}(y_1, \dots, y_m)$ . Then let

$$D(y_1, \dots, y_m) = \det(a_{j\alpha}(y_1, \dots, y_m) : 1 \leq j \leq N_r, |\alpha| = r)$$

be the corresponding determinant. If we substitute  $\mathbf{c}$  into (4), we obtain

$$G_j(x_0, \dots, x_n, \mathbf{c}) = \sum_{|\alpha|=r} a_{j\alpha}(\mathbf{c})x^\alpha,$$

and since the  $G_j(x_0, \dots, x_n, \mathbf{c})$ 's and  $x^\alpha$ 's are bases of the same vector space, we see that

$$D(\mathbf{c}) \neq 0.$$

In particular, this shows that  $D(y_1, \dots, y_m) \neq 0$  in  $k[y_1, \dots, y_m]$ .

Working over the function field  $k(y_1, \dots, y_m)$  (see Chapter 5, §5), we can regard (4) as a system of linear equations over  $k(y_1, \dots, y_m)$  with the  $x^\alpha$  as variables. Applying Cramer's Rule (Proposition 3 of Appendix A, §3), we conclude that

$$x^\alpha = \frac{\det(M_\alpha)}{D(y_1, \dots, y_m)},$$

where  $M_\alpha$  is the matrix obtained from  $(a_{j\alpha})$  by replacing the  $\alpha$  column by  $G_1, \dots, G_{N_r}$ . If we multiply each side by  $D(y_1, \dots, y_m)$  and expand  $\det(M_\alpha)$  along this column, we get an equation of the form

$$x^\alpha D(y_1, \dots, y_m) = \sum_{j=1}^{N_r} H_{j\alpha}(y_1, \dots, y_m) G_j(x_0, \dots, x_n, y_1, \dots, y_m).$$



However, every  $G_j$  is of the form  $x^{\beta_i} F_i$ , and if we make this substitution and write the sum in terms of the  $F_i$ , we obtain

$$x^\alpha D(y_1, \dots, y_m) \in \langle F_1, \dots, F_s \rangle = I.$$

This shows that  $D(y_1, \dots, y_m)$  is in the projective elimination ideal  $\hat{I}$ , and since  $\mathbf{c} \in \mathbf{V}(\hat{I})$ , we conclude that  $D(\mathbf{c}) = 0$ . This contradicts what we found above, which proves that  $\mathbf{c} \in \pi(V)$ , as desired.  $\square$

Theorem 6 tells us that when we project a variety  $V \subset \mathbb{P}^n \times k^m$  into  $k^m$ , the result is again a variety. This has the following nice interpretation: if we think of the variables  $y_1, \dots, y_m$  as parameters in the system of equations

$$F_1(x_0, \dots, x_n, y_1, \dots, y_m) = \dots = F_s(x_0, \dots, x_n, y_1, \dots, y_m) = 0,$$

then the equations defining  $\pi(V) = \mathbf{V}(\hat{I})$  in  $k^m$  tell us what conditions the parameters must satisfy in order for the above equations to have a nontrivial solution (i.e., a solution different from  $x_0 = \dots = x_n = 0$ ).

For the elimination theory given in Theorem 6 to be useful, we need to be able to compute the elimination ideal  $\hat{I}$ . We will explore this question in the following two propositions. We first show how to represent  $\hat{I}$  as an ideal quotient.

**Proposition 7.** *If  $I \subset k[x_0, \dots, x_n, y_1, \dots, y_m]$  is an ideal, then, for all sufficiently large integers  $e$ , we have*

$$\hat{I} = (I : \langle x_0^e, \dots, x_n^e \rangle) \cap k[y_1, \dots, y_m].$$

**Proof.** The definition of ideal quotient shows that

$$f \in I : \langle x_0^e, \dots, x_n^e \rangle \implies x_i^e f \in I \quad \text{for all } 0 \leq i \leq n.$$

It follows immediately that  $(I : \langle x_0^e, \dots, x_n^e \rangle) \cap k[y_1, \dots, y_m] \subset \hat{I}$  for all  $e \geq 0$ .

We need to show that the opposite inclusion occurs for large  $e$ . First, observe that we have an ascending chain of ideals

$$I : \langle x_0, \dots, x_n \rangle \subset I : \langle x_0^2, \dots, x_n^2 \rangle \subset \dots$$

Then the ascending chain condition (Theorem 7 of Chapter 2, §5) implies that

$$I : \langle x_0^e, \dots, x_n^e \rangle = I : \langle x_0^{e+1}, \dots, x_n^{e+1} \rangle = \dots$$

for some integer  $e$ . If we fix such an  $e$ , it follows that

$$(5) \quad I : \langle x_0^d, \dots, x_n^d \rangle \subset I : \langle x_0^e, \dots, x_n^e \rangle$$

for all integers  $d \geq 0$ .

Now suppose  $f \in \hat{I}$ . For each  $0 \leq i \leq n$ , this means  $x_i^{e_i} f \in I$  for some  $e_i \geq 0$ . Let  $d = \max(e_0, \dots, e_n)$ . Then  $x_i^d f \in I$  for all  $i$ , which implies  $f \in I : \langle x_0^d, \dots, x_n^d \rangle$ . By (5), it follows that  $f \in (I : \langle x_0^e, \dots, x_n^e \rangle) \cap k[y_1, \dots, y_m]$ , and the proposition is proved.  $\square$

We next relate  $\hat{I}$  to the kind of elimination we did in Chapter 3. The basic idea is to reduce to the affine case by dehomogenization. If we fix  $0 \leq i \leq n$ , then setting  $x_i = 1$  in  $F \in k[x_0, \dots, x_n, y_1, \dots, y_m]$  gives the polynomial

$$F^{(i)} = F(x_0, \dots, 1, \dots, x_n, y_1, \dots, y_m) \in k[x_0, \dots, \hat{x}_i, \dots, x_n, y_1, \dots, y_m],$$

where  $\hat{x}_i$  means that  $x_i$  is omitted from the list of variables. Then, given an ideal  $I \subset k[x_0, \dots, x_n, y_1, \dots, y_m]$ , we get the *dehomogenization*

$$I^{(i)} = \{F^{(i)} : F \in I\} \subset k[x_0, \dots, \hat{x}_i, \dots, x_n, y_1, \dots, y_m].$$

It is easy to show that  $I^{(i)}$  is an ideal in  $k[x_0, \dots, \hat{x}_i, \dots, x_n, y_1, \dots, y_m]$ . We also leave it as an exercise to show that if  $I = \langle F_1, \dots, F_s \rangle$ , then

$$(6) \quad I^{(i)} = \langle F_1^{(i)}, \dots, F_s^{(i)} \rangle.$$

Let  $V \subset \mathbb{P}^n \times k^m$  be the variety defined by  $I$ . One can think of  $I^{(i)}$  as defining the affine portion  $V \cap (U_i \times k^m)$ , where  $U_i \cong k^n$  is the subset of  $\mathbb{P}^n$  where  $x_i = 1$ . Since we are now in a purely affine situation, we can eliminate using the methods of Chapter 3. In particular, we get the  $n$ -th elimination ideal

$$I_n^{(i)} = I^{(i)} \cap k[y_1, \dots, y_m],$$

where the subscript  $n$  indicates that the  $n$  variables  $x_0, \dots, \hat{x}_i, \dots, x_n$  have been eliminated. We now compute  $\hat{I}$  in terms of its dehomogenizations  $I^{(i)}$  as follows.

**Proposition 8.** *Let  $I \subset k[x_0, \dots, x_n, y_1, \dots, y_m]$  be an ideal that is generated by  $(x_0, \dots, x_n)$ -homogeneous polynomials. Then*

$$\hat{I} = I_n^{(0)} \cap I_n^{(1)} \cap \dots \cap I_n^{(n)}.$$

**Proof.** It suffices to show that

$$\hat{I} = I^{(0)} \cap \dots \cap I^{(n)} \cap k[y_1, \dots, y_m].$$

First, suppose that  $f \in \hat{I}$ . Then  $x_i^{e_i} f(y_1, \dots, y_m) \in I$ , so that when we set  $x_i = 1$ , we get  $f(y_1, \dots, y_m) \in I^{(i)}$ . This proves  $f \in I^{(0)} \cap \dots \cap I^{(n)} \cap k[y_1, \dots, y_m]$ .

For the other inclusion, we first study the relation between  $I$  and  $I^{(i)}$ . An element  $f \in I^{(i)}$  is obtained from some  $F \in I$  by setting  $x_i = 1$ . We claim that  $F$  can be assumed to be  $(x_0, \dots, x_n)$ -homogeneous. To prove this, note that  $F$  can be written as a sum  $F = \sum_{j=0}^d F_j$ , where  $F_j$  is  $(x_0, \dots, x_n)$ -homogeneous of total degree  $j$  in  $x_0, \dots, x_n$ . Since  $I$  is generated by  $(x_0, \dots, x_n)$ -homogeneous polynomials, the proof of Theorem 2 of §3 can be adapted to show that  $F_j \in I$  for all  $j$  (see Exercise 4). This implies that

$$\sum_{j=0}^d x_i^{d-j} F_j$$

is a  $(x_0, \dots, x_n)$ -homogeneous polynomial in  $I$  which dehomogenizes to  $f$  when  $x_i = 1$ . Thus, we can assume that  $F \in I$  is  $(x_0, \dots, x_n)$ -homogeneous.

As in §2, we can define a homogenization operator which takes a polynomial  $f \in k[x_0, \dots, \hat{x}_i, \dots, x_n, y_1, \dots, y_m]$  and uses the extra variable  $x_i$  to produce a

$(x_0, \dots, x_n)$ -homogeneous polynomial  $f^h \in k[x_0, \dots, x_n, y_1, \dots, y_m]$ . We leave it as an exercise to show that if a  $(x_0, \dots, x_n)$ -homogeneous polynomial  $F$  dehomogenizes to  $f$  using  $x_i = 1$ , then

$$(7) \quad F = x_i^e f^h$$

for some integer  $e \geq 0$ .

Now suppose  $f \in I^{(i)} \cap k[y_1, \dots, y_m]$ . As we proved earlier,  $f$  comes from  $F \in I$  which is  $(x_0, \dots, x_n)$ -homogeneous. Since  $f$  does not involve  $x_0, \dots, x_n$ , we have  $f = f^h$ , and then (7) implies  $x_i^e f \in I$ . It follows immediately that  $I^{(0)} \cap \dots \cap I^{(n)} \cap k[y_1, \dots, y_m] \subset \hat{I}$ , and the proposition is proved.  $\square$

Proposition 8 has a nice interpretation. Namely,  $I_n^{(i)}$  can be thought of as eliminating  $x_0, \dots, \hat{x}_i, \dots, x_n$  on the affine piece of  $\mathbb{P}^n \times k^m$  where  $x_i = 1$ . Then intersecting these affine elimination ideals (which roughly corresponds to the eliminating on the union of the affine pieces) gives the projective elimination ideal.

We can also use Proposition 8 to give an algorithm for finding  $\hat{I}$ . If  $I = \langle F_1, \dots, F_s \rangle$ , we know a basis of  $I^{(i)}$  by (6), so that we can compute  $I_n^{(i)}$  using the Elimination Theorem of Chapter 3, §1. Then the algorithm for ideal intersections from Chapter 4, §3 tells us how to compute  $\hat{I} = I_n^{(0)} \cap \dots \cap I_n^{(n)}$ . A second algorithm for computing  $\hat{I}$ , based on Proposition 7, will be discussed in the exercises.

To see how this works in practice, consider the equations

$$\begin{aligned} F_1 &= u + vy = 0, \\ F_2 &= u + uy = 0 \end{aligned}$$

from Example 3. If we set  $I = \langle u + vy, u + uy \rangle \subset k[u, v, y]$ , then we have

$$\begin{aligned} \text{when } u = 1 : I_1^{(u)} &= \langle 1 + vy, 1 + y \rangle \cap k[y] = \langle 1 + y \rangle, \\ \text{when } v = 1 : I_1^{(v)} &= \langle u + y, u + uy \rangle \cap k[y] = \langle y(1 + y) \rangle, \end{aligned}$$

and it follows that  $\hat{I} = I_1^{(u)} \cap I_1^{(v)} = \langle y(1 + y) \rangle$ . Can you explain why  $I_1^{(u)}$  and  $I_1^{(v)}$  are different?

We next return to a question posed earlier concerning the missing points that can occur in the affine case. An ideal  $I \subset k[x_1, \dots, x_n, y_1, \dots, y_m]$  gives a variety  $V = \mathbf{V}_a(I) \subset k^n \times k^m$ , and under the projection  $\pi : k^n \times k^m \rightarrow k^m$ , we know that  $\pi(V) \subset \mathbf{V}(I_n)$ , where  $I_n$  is the  $n$ -th elimination ideal of  $I$ . We want to show that points in  $\mathbf{V}(I_n) - \pi(V)$  come from points at infinity in  $\mathbb{P}^n \times k^m$ .

To decide what variety in  $\mathbb{P}^n \times k^m$  to use, we will homogenize with respect to  $x_0$ . Recall from the proof of Proposition 8 that  $f \in k[x_1, \dots, x_n, y_1, \dots, y_m]$  gives us a  $(x_0, \dots, x_n)$ -homogeneous polynomial  $f^h \in k[x_0, \dots, x_n, y_1, \dots, y_m]$ . Exercise 12 will study homogenization in more detail. Then the  $(x_0, \dots, x_n)$ -homogenization of  $I$  is defined to be the ideal

$$I^h = \langle f^h : f \in I \rangle \subset k[x_0, \dots, x_n, y_1, \dots, y_m].$$

Using the Hilbert Basis Theorem, it follows easily that  $I^h$  is generated by finitely many  $(x_0, \dots, x_n)$ -homogeneous polynomials.

The following proposition gives the main properties of  $I^h$ .

**Proposition 9.** *Given an ideal  $I \subset k[x_1, \dots, x_n, y_1, \dots, y_m]$ , let  $I^h$  be its  $(x_0, \dots, x_n)$ -homogenization. Then:*

- (i) *The projective elimination ideal of  $I^h$  equals the  $n$ -th elimination ideal of  $I$ . Thus,  $\widehat{I^h} = I_n \subset k[y_1, \dots, y_m]$ .*
- (ii) *If  $k$  is algebraically closed, then the variety  $\overline{V} = \mathbf{V}(I^h)$  is the smallest variety in  $\mathbb{P}^n \times k^m$  containing the affine variety  $V = \mathbf{V}_a(I) \subset k^n \times k^m$ . We call  $\overline{V}$  the **projective closure of  $V$  in  $\mathbb{P}^n \times k^m$** .*

**Proof.** (i) It is straightforward to show that dehomogenizing  $I^h$  with respect to  $x_0$  gives  $(I^h)^{(0)} = I$ . Then the proof of Proposition 8 implies that  $\widehat{I^h} \subset I_n$ . Going the other way, take  $f \in I_n$ . Since  $f \in k[y_1, \dots, y_m]$ , it is already  $(x_0, \dots, x_n)$ -homogeneous. Hence,  $f = f^h \in I^h$  and it follows that  $x_i^0 f \in I^h$  for all  $i$ . This shows that  $f \in \widehat{I^h}$ , and (i) is proved.

Part (ii) is similar to Theorem 8 of §4 and is left as an exercise. □

Using Theorem 6 and Proposition 9 together, we get the following nice result.

**Corollary 10.** *Assume that  $k$  is algebraically closed and let  $V = \mathbf{V}_a(I) \subset k^n \times k^m$ , where  $I \subset k[x_1, \dots, x_n, y_1, \dots, y_m]$  is an ideal. Then*

$$\mathbf{V}(I_n) = \pi(\overline{V}),$$

where  $\overline{V} \subset \mathbb{P}^n \times k^m$  is the projective closure of  $V$  and  $\pi: \mathbb{P}^n \times k^m \rightarrow k^m$  is the projection

**Proof.** Since Proposition 9 tells us that  $\overline{V} = \mathbf{V}(I^h)$  and  $\widehat{I^h} = I_n$ , the corollary follows immediately from Theorem 6. □

In Chapter 3, points of  $\mathbf{V}(I_n)$  were called “partial solutions.” The partial solutions which do not extend to solutions in  $V$  give points of  $\mathbf{V}(I_n) - \pi(V)$ , and the corollary shows that these points come from points at infinity in the projective closure  $\overline{V}$  of  $V$ .

To use Corollary 10, we need to be able to compute  $I^h$ . As in §4, the difficulty is that  $I = \langle f_1, \dots, f_s \rangle$  need not imply  $I^h = \langle f_1^h, \dots, f_s^h \rangle$ . But if we use an appropriate Groebner basis, we get the desired equality.

**Proposition 11.** *Let  $>$  be a monomial order on  $k[x_1, \dots, x_n, y_1, \dots, y_m]$  such that for all monomials  $x^\alpha y^\gamma, x^\beta y^\delta$  in  $x_1, \dots, x_n, y_1, \dots, y_m$ , we have*

$$|\alpha| > |\beta| \implies x^\alpha y^\gamma > x^\beta y^\delta.$$

*If  $G = \{g_1, \dots, g_s\}$  is a Groebner basis for  $I \subset k[x_1, \dots, x_n, y_1, \dots, y_m]$  with respect to  $>$ , then  $G^h = \{g_1^h, \dots, g_s^h\}$  is a basis for  $I^h \subset k[x_0, \dots, x_n, y_1, \dots, y_m]$ .*

**Proof.** This is similar to Theorem 4 of §4 and is left as an exercise. □

In Example 1, we considered  $I = \langle xy^2 - x + 1 \rangle \subset \mathbb{C}[x, y]$ . This is a principal ideal and, hence,  $xy^2 - x + 1$  is a Groebner basis for any monomial ordering (see Exercise 10 of Chapter 2, §5). If we homogenize with respect to the new variable  $t$ , Proposition 11 tells us that  $I^h$  is generated by the  $(t, x)$ -homogeneous polynomial  $xy^2 - x + t$ . Now let  $\bar{V} = \mathbf{V}(I^h) \subset \mathbb{P}^1 \times \mathbb{C}$ . Then Corollary 10 shows  $\pi(\bar{V}) = \mathbf{V}(I_1) = \mathbb{C}$ , which agrees with what we found in Example 1.

Using Corollary 10 and Proposition 11, we can point out a weakness in the Geometric Extension Theorem given in Chapter 3. This theorem stated that if  $I = \langle f_1, \dots, f_s \rangle$ , then

$$(8) \quad \mathbf{V}(I_1) = \pi(V) \cup (\mathbf{V}(g_1, \dots, g_s) \cap \mathbf{V}(I_1)),$$

where  $V = \mathbf{V}_a(I)$  and  $g_i \in k[x_2, \dots, x_n]$  is the leading coefficient of  $f_i$  with respect to  $x_1$ . From the projective point of view,  $\{(0, 1)\} \times V(g_1, \dots, g_s)$  are the points at infinity in  $Z = \mathbf{V}(f_1^h, \dots, f_s^h)$  (this follows from the proof of Theorem 6). Since  $f_1, \dots, f_s$  was an arbitrary basis of  $I$ ,  $Z$  may not be the projective closure of  $V$  and, hence,  $\mathbf{V}(g_1, \dots, g_s)$  may be too large. To get the smallest possible  $\mathbf{V}(g_1, \dots, g_s) \cap \mathbf{V}(I_1)$  in (8), we should use a Groebner basis for  $I$  with respect to a monomial ordering of the type described in Proposition 11.

We will end the section with a study of maps between projective spaces. Suppose that  $f_0, \dots, f_m \in k[x_0, \dots, x_n]$  are homogeneous polynomials of total degree  $d$  such that  $\mathbf{V}(f_0, \dots, f_m) = \emptyset$  in  $\mathbb{P}^n$ . Then we can define a map  $F : \mathbb{P}^n \rightarrow \mathbb{P}^m$  by the formula

$$F(x_0, \dots, x_n) = (f_0(x_0, \dots, x_n), \dots, f_m(x_0, \dots, x_n)).$$

Since  $f_0, \dots, f_m$  never vanish simultaneously on  $\mathbb{P}^n$ ,  $F(x_0, \dots, x_n)$  always gives a point in  $\mathbb{P}^m$ . Furthermore, since the  $f_i$  are all homogeneous of total degree  $d$ , it follows that

$$F(\lambda x_0, \dots, \lambda x_n) = \lambda^d F(x_0, \dots, x_n)$$

for all  $\lambda \in k - \{0\}$ . Thus,  $F$  is a well-defined function from  $\mathbb{P}^n$  to  $\mathbb{P}^m$ .

We have already seen examples of such maps between projective spaces. For instance, Exercise 21 of §2 studied the map  $F : \mathbb{P}^1 \rightarrow \mathbb{P}^2$  defined by

$$F(a, b) = (a^2 + b^2, 2ab, a^2 - b^2).$$

This is a projective parametrization of  $\mathbf{V}(x^2 - y^2 - z^2)$ . Also, Exercise 12 of §4 discussed the Veronese map  $\phi : \mathbb{P}^2 \rightarrow \mathbb{P}^5$  defined by

$$\phi(x_0, x_1, x_2) = (x_0^2, x_0x_1, x_0x_2, x_1^2, x_1x_2, x_2^2).$$

The image of this map is called the Veronese surface in  $\mathbb{P}^5$ .

Over an algebraically closed field, we can describe the image of  $F : \mathbb{P}^n \rightarrow \mathbb{P}^m$  using elimination theory as follows.

**Theorem 12.** *Let  $k$  be algebraically closed and let  $F : \mathbb{P}^n \rightarrow \mathbb{P}^m$  be defined by homogeneous polynomials  $f_0, \dots, f_m \in k[x_0, \dots, x_n]$  which have the same total*

degree  $> 0$  and no common zeros in  $\mathbb{P}^n$ . In  $k[x_0, \dots, x_n, y_0, \dots, y_m]$ , let  $I$  be the ideal  $\langle y_0 - f_0, \dots, y_m - f_m \rangle$  and let  $I_{n+1} = I \cap k[y_0, \dots, y_m]$ . Then  $I_{n+1}$  is a homogeneous ideal in  $k[y_0, \dots, y_m]$  and

$$F(\mathbb{P}^n) = \mathbf{V}(I_{n+1}).$$

**Proof.** We will first show that  $I_{n+1}$  is a homogeneous ideal. Suppose that the  $f_i$  have total degree  $d$ . Since the generators  $y_i - f_i$  of  $I$  are not homogeneous (unless  $d = 1$ ), we will introduce *weights* on the variables  $x_0, \dots, x_n, y_0, \dots, y_m$ . We say that each  $x_i$  has weight 1 and each  $y_j$  has weight  $d$ . Then a monomial  $x^\alpha y^\beta$  has weight  $|\alpha| + d|\beta|$ , and a polynomial  $f \in k[x_0, \dots, x_n, y_0, \dots, y_m]$  is *weighted homogeneous* provided every monomial in  $f$  has the same weight.

The generators  $y_i - f_i$  of  $I$  all have weight  $d$ , so that  $I$  is a weighted homogeneous ideal. If we compute a reduced Groebner basis  $G$  for  $I$  with respect to any monomial order, an argument similar to the proof of Theorem 2 of §3 shows that  $G$  consists of weighted homogeneous polynomials. For an appropriate lex order, the Elimination Theorem from Chapter 3 shows that  $G \cap k[y_0, \dots, y_m]$  is a basis of  $I_{n+1} = I \cap k[y_0, \dots, y_m]$ . Thus,  $I_{n+1}$  has a weighted homogeneous basis. Since the  $y_i$ 's all have the same weight, a polynomial in  $k[y_0, \dots, y_m]$  is weighted homogeneous if and only if it is homogeneous in the usual sense. This proves that  $I_{n+1}$  is a homogeneous ideal.

To study the image of  $F$ , we need to consider varieties in the product  $\mathbb{P}^n \times \mathbb{P}^m$ . A polynomial  $h \in k[x_0, \dots, x_n, y_0, \dots, y_m]$  is *bihomogeneous* if it can be written as

$$h = \sum_{|\alpha|=k, |\beta|=l} a_{\alpha\beta} x^\alpha y^\beta.$$

If  $h_1, \dots, h_s$  are bihomogeneous, we get a well-defined set

$$\mathbf{V}(h_1, \dots, h_s) \subset \mathbb{P}^n \times \mathbb{P}^m$$

which is the *variety* defined by  $h_1, \dots, h_s$ . Similarly, if  $J \subset k[x_0, \dots, x_n, y_0, \dots, y_m]$  is generated by bihomogeneous polynomials, then we get a variety  $\mathbf{V}(J) \subset \mathbb{P}^n \times \mathbb{P}^m$ . (See Exercise 16 for the details.)

Elimination theory applies nicely to this situation. The projective elimination ideal  $\hat{J} \subset k[y_0, \dots, y_m]$  is a homogeneous ideal (see Exercise 16). Then, using the projection  $\pi : \mathbb{P}^n \times \mathbb{P}^m \rightarrow \mathbb{P}^m$ , it is an easy corollary of Theorem 6 that

$$(9) \quad \pi(\mathbf{V}(J)) = \mathbf{V}(\hat{J})$$

in  $\mathbb{P}^m$  (see Exercise 16). As in Theorem 6, this requires that  $k$  be algebraically closed.

We cannot apply this theory to  $I$  because it is not generated by bihomogeneous polynomials. So we will work with the bihomogeneous ideal  $J = \langle y_i f_j - y_j f_i \rangle$ . Let us first show that  $\mathbf{V}(J) \subset \mathbb{P}^n \times \mathbb{P}^m$  is the graph of  $F : \mathbb{P}^n \rightarrow \mathbb{P}^m$ . Given  $p \in \mathbb{P}^n$ , we have  $(p, F(p)) \in \mathbf{V}(J)$  since  $y_i = f_i(p)$  for all  $i$ . Conversely, suppose that  $(p, q) \in \mathbf{V}(J)$ . Then  $q_i f_j(p) = q_j f_i(p)$  for all  $i, j$ , where  $q_i$  is the  $i$ -th homogeneous coordinate of  $q$ . We can find  $j$  with  $q_j \neq 0$ , and by our assumption on  $f_0, \dots, f_m$ , there is  $i$  with  $f_i(p) \neq 0$ . Then  $q_i f_j(p) = q_j f_i(p) \neq 0$  shows that  $q_i \neq 0$ . Now let  $\lambda = q_i / f_i(p)$ ,

which is a nonzero element of  $k$ . From the defining equations of  $\mathbf{V}(J)$ , it follows easily that  $q = \lambda F(p)$ , which shows that  $(p, q)$  is in the graph of  $F$  in  $\mathbb{P}^n \times \mathbb{P}^m$ .

As we saw in §3 of Chapter 3, the projection of the graph is the image of the function. Thus, under  $\pi : \mathbb{P}^n \times \mathbb{P}^m \rightarrow \mathbb{P}^m$ , we have  $\pi(\mathbf{V}(J)) = F(\mathbb{P}^n)$ . If we combine this with (9), we get  $F(\mathbb{P}^n) = \mathbf{V}(\hat{J})$  since  $k$  is algebraically closed. This proves that the image of  $F$  is a variety in  $\mathbb{P}^m$ .

Since we know an algorithm for computing  $\hat{J}$ , we could stop here. The problem is that  $\hat{J}$  is somewhat complicated to compute. It is much simpler to work with  $I_{n+1} = I \cap k[y_0, \dots, y_m]$ , which requires nothing more than the methods of Chapter 3. So the final step in the proof is to show that  $\mathbf{V}(\hat{J}) = \mathbf{V}(I_{n+1})$  in  $\mathbb{P}^m$ .

It suffices to work in affine space  $k^{m+1}$  and prove that  $\mathbf{V}_a(\hat{J}) = \mathbf{V}_a(I_{n+1})$ . Observe that the variety  $\mathbf{V}_a(I) \subset k^{n+1} \times k^{m+1}$  is the graph of the map  $k^{n+1} \rightarrow k^{m+1}$  defined by  $(f_0, \dots, f_m)$ . Under the projection  $\pi : k^{n+1} \times k^{m+1} \rightarrow k^{m+1}$ , we claim that  $\pi(\mathbf{V}_a(I)) = \mathbf{V}_a(\hat{J})$ . We know that  $\mathbf{V}(\hat{J})$  is the image of  $F$  in  $\mathbb{P}^m$ . Once we exclude the origin, this means that  $q \in \mathbf{V}_a(\hat{J})$  if and only if there is a some  $p \in k^{n+1}$  such that  $q$  equals  $F(p)$  in  $\mathbb{P}^m$ . Hence,  $q = \lambda F(p)$  in  $k^{m+1}$  for some  $\lambda \neq 0$ . If we set  $\lambda' = \sqrt[m]{\lambda}$ , then  $q = F(\lambda' p)$ , which is equivalent to  $q \in \pi(\mathbf{V}_a(I))$ . The claim now follows easily.

By the Closure Theorem (Theorem 3 of Chapter 3, §2),  $\mathbf{V}_a(I_{n+1})$  is the smallest variety containing  $\pi(\mathbf{V}_a(I))$ . Since this projection equals the variety  $\mathbf{V}_a(\hat{J})$ , it follows immediately that  $\mathbf{V}_a(I_{n+1}) = \mathbf{V}_a(\hat{J})$ . This completes the proof of the theorem.  $\square$

**EXERCISES FOR §5**

1. In Example 1, explain why  $xy^2 - x + t = 0$  determines a well-defined subset of  $\mathbb{P}^1 \times \mathbb{C}$ , where  $(t, x)$  are homogeneous coordinates on  $\mathbb{P}^1$  and  $y$  is a coordinate on  $\mathbb{C}$ . Hint: See Exercise 2.
2. Suppose  $F \in k[x_0, \dots, x_n, y_1, \dots, y_m]$  is  $(x_0, \dots, x_n)$ -homogeneous. Show that if  $F$  vanishes at one set of coordinates for a point in  $\mathbb{P}^n \times k^m$ , then  $F$  vanishes at all coordinates for the point.
3. In Example 3, show that  $\mathbf{V}(F_1, F_2) = \{(0, 1, 0), (1, 1, -1)\}$ .
4. This exercise will study ideals generated by  $(x_0, \dots, x_n)$ -homogeneous polynomials.
  - a. Prove that every  $F \in k[x_0, \dots, x_n, y_1, \dots, y_m]$  can be written uniquely as a sum  $\sum_i F_i$  where  $F_i$  is a  $(x_0, \dots, x_n)$ -homogeneous polynomial of degree  $i$  in  $x_0, \dots, x_n$ . We call these the  $(x_0, \dots, x_n)$ -homogeneous components of  $F$ .
  - b. Prove that an ideal  $I \subset k[x_0, \dots, x_n, y_1, \dots, y_m]$  is generated by  $(x_0, \dots, x_n)$ -homogeneous polynomials if and only if  $I$  contains the  $(x_0, \dots, x_n)$ -homogeneous components of each of its elements.
5. Let  $I \subset k[x_0, \dots, x_n, y_1, \dots, y_m]$  be an ideal generated by  $(x_0, \dots, x_n)$ -homogeneous polynomials. We will discuss a method for computing the ideal  $(I : x_i) \cap k[y_1, \dots, y_m]$ . For convenience, we will concentrate on the case  $i = 0$ . Let  $>$  be lex order with  $x_1 > \dots > x_n > x_0 > y_1 > \dots > y_m$  and let  $G$  be a reduced Groebner basis for  $I$ .
  - a. Suppose that  $g \in G$  has  $\text{LT}(g) = x_0 y^\alpha$ . Prove that  $g = x_0 h_1(y_1, \dots, y_m) + h_0(y_1, \dots, y_m)$ .
  - b. If  $g \in G$  has  $\text{LT}(g) = x_0 y^\alpha$ . Prove that  $g = x_0 h_1(y_1, \dots, y_m)$ . Hint: Use part (b) of Exercise 4 and the fact that  $G \cap k[y_1, \dots, y_m]$  is a Groebner basis of  $I \cap k[y_1, \dots, y_m]$ . Remember that  $G$  is reduced.

- c. Let  $G' = \{g \in k[y_1, \dots, y_m] : \text{either } g \text{ or } x_0g \in G\}$ . Show that  $G' \subset (I : x_0) \cap k[y_1, \dots, y_m]$  and that the leading term of every element of  $(I : x_0) \cap k[y_1, \dots, y_m]$  is divisible by the leading term of some element of  $G'$ . This shows that  $G'$  is a Groebner basis.
- d. Explain how to compute  $(I : x_0^e) \cap k[y_1, \dots, y_m]$ .
- 6. In Example 3, we claimed that  $(I : \langle u, v \rangle) \cap k[y] = \langle y(1+y) \rangle$  when  $I = \langle u+vy, u+uy \rangle \subset k[u, v, y]$ . Prove this using the method of Exercise 5. Hint:  $I : \langle u, v \rangle = \langle I : u \rangle \cap \langle I : v \rangle$ . Also, the needed Groebner bases have already been computed in Example 3.
- 7. As in Example 3, we will use  $(u, v, y)$  as coordinates on  $\mathbb{P}^1 \times k$ . Let  $F_1 = u - vy$  and  $F_2 = u^2 - v^2y$  in  $k[u, v, y]$ .
  - a. Compute  $\mathbf{V}(F_1, F_2)$  and explain geometrically why eliminating  $u$  and  $v$  should lead to the equation  $y(1 - y) = 0$ .
  - b. By computing appropriate Groebner bases, show that  $u^2y(1 - y)$  and  $v^2y^2(1 - y)$  lie in  $I = \langle F_1, F_2 \rangle$ , whereas  $uy(1 - y)$  and  $vy(1 - y)$  do not.
  - c. Show that  $(I : \langle u, v \rangle) \cap k[y] = \{0\}$  and that  $(I : \langle u^2, v^2 \rangle) \cap k[y] = \langle y(1 - y) \rangle$ . Hint: Use Exercise 5.
- 8. Prove that the set  $\hat{I}$  defined in Definition 4 is an ideal of  $k[y_1, \dots, y_m]$ . Note: Although this follows from Proposition 7, you should give a direct argument using the definition.
- 9. Let  $I \subset k[x_0, \dots, x_n, y_1, \dots, y_m]$  be an ideal. Adapt the argument of Proposition 7 to show that

$$\hat{I} = (I : \langle x_0, \dots, x_n \rangle^e) \cap k[y_1, \dots, y_m]$$

for all sufficiently large integers  $e$ . Hint: By Exercise 8 of §3,  $\langle x_0, \dots, x_n \rangle^e$  is generated by all monomials  $x^\alpha$  of total degree  $e$ .

- 10. In this exercise, we will use Proposition 7 to describe an algorithm for computing the projective elimination ideal  $\hat{I}$ .
  - a. Show that if  $I : \langle x_0^e, \dots, x_n^e \rangle = I : \langle x_0^{e+1}, \dots, x_n^{e+1} \rangle$  for  $e \geq 0$ , then  $I : \langle x_0^e, \dots, x_n^e \rangle = (I : \langle x_0^d, \dots, x_n^d \rangle)$  for all  $d \geq e$ .
  - b. Use part (a) to describe an algorithm for finding an integer  $e$  such that  $\hat{I}$  is given by  $(I : \langle x_0^e, \dots, x_n^e \rangle) \cap k[y_1, \dots, y_m]$ .
  - c. Once we know  $e$ , use algorithms from Chapters 3 and 4 to explain how we can compute  $\hat{I}$  using Proposition 7.
- 11. In this exercise, we will use dehomogenization operator  $F \mapsto F^{(i)}$  defined in the discussion preceding Proposition 8.
  - a. Prove that  $I^{(i)} = \{F^{(i)} : F \in I\}$  is an ideal in  $k[x_0, \dots, \hat{x}_i, \dots, x_n, y_1, \dots, y_m]$ .
  - b. If  $I = \langle F_1, \dots, F_s \rangle$ , then show that  $I^{(i)} = \langle F_1^{(i)}, \dots, F_s^{(i)} \rangle$ .
- 12. In the proof of Proposition 8, we needed the homogenization operator, which makes a polynomial  $f \in k[x_1, \dots, x_n, y_1, \dots, y_m]$  into a  $(x_0, \dots, x_n)$ -homogeneous polynomial  $f^h$  using the extra variable  $x_0$ .
  - a. Give a careful definition of  $f^h$ .
  - b. If we dehomogenize  $f^h$  by setting  $x_0 = 1$ , show that we get  $(f^h)^{(0)} = f$ .
  - c. Let  $f = F^{(0)}$  be the dehomogenization of a  $(x_0, \dots, x_n)$ -homogeneous polynomial  $F$ . Then prove that  $F = x_0^e f^h$  for some integer  $e \geq 0$ .
- 13. Prove part (ii) of Proposition 9.
- 14. Prove Proposition 11. Also give an example of a monomial order which satisfies the hypothesis of the proposition. Hint: You can use an appropriate weight order from Exercise 12 of Chapter 2, §4.
- 15. The proof of Theorem 12 used weighted homogeneous polynomials. The general setup is as follows. Given variables  $x_0, \dots, x_n$ , we assume that each variable has a weight  $q_i$ , which



we assume to be a positive integer. Then the *weight* of a monomial  $x^\alpha$  is  $\sum_{i=0}^n q_i \alpha_i$ , where  $\alpha = (\alpha_0, \dots, \alpha_n)$ . A polynomial is weighted homogeneous if all of its monomials have the same weight.

- a. Show that every  $f \in k[x_0, \dots, x_n]$  can be written uniquely as a sum of weighted homogeneous polynomials  $\sum_i f_i$ , where  $f_i$  is weighted homogeneous of weight  $i$ . These are called the *weighted homogeneous components* of  $f$ .
  - b. Define what it means for an ideal  $I \subset k[x_0, \dots, x_n]$  to be a *weighted homogeneous ideal*. Then formulate and prove a version of Theorem 2 of §3 for weighted homogeneous ideals.
16. This exercise will study the elimination theory of  $\mathbb{P}^n \times \mathbb{P}^m$ . We will use the polynomial ring  $k[x_0, \dots, x_n, y_0, \dots, y_m]$ , where  $(x_0, \dots, x_n)$  are homogeneous coordinates on  $\mathbb{P}^n$  and  $(y_0, \dots, y_m)$  are homogeneous coordinates on  $\mathbb{P}^m$ .

- a. As in the text,  $h \in k[x_0, \dots, x_n, y_0, \dots, y_m]$  is *bihomogeneous* if it can be written in the form

$$h = \sum_{|\alpha|=k, |\beta|=l} a_{\alpha\beta} x^\alpha y^\beta.$$

We say that  $h$  has *bidegree*  $(k, l)$ . If  $h_1, \dots, h_s$  are bihomogeneous, show that we get a well-defined variety

$$\mathbf{V}(h_1, \dots, h_s) \subset \mathbb{P}^n \times \mathbb{P}^m.$$

Also, if  $J \subset k[x_0, \dots, x_n, y_0, \dots, y_m]$  is an ideal generated by bihomogeneous polynomials, explain how to define  $\mathbf{V}(J) \subset \mathbb{P}^n \times \mathbb{P}^m$  and prove that  $\mathbf{V}(J)$  is a variety.

- b. If  $J$  is generated by bihomogeneous polynomials, we have  $V = \mathbf{V}(J) \subset \mathbb{P}^n \times \mathbb{P}^m$ . Since  $J$  is also  $(x_0, \dots, x_n)$ -homogeneous, we can form its projective elimination ideal  $\hat{J} \subset k[y_0, \dots, y_m]$ . Prove that  $\hat{J}$  is a homogeneous ideal.
- c. Now assume that  $k$  is algebraically closed. Under the projection  $\pi : \mathbb{P}^n \times \mathbb{P}^m \rightarrow \mathbb{P}^m$ , prove that

$$\pi(V) = \mathbf{V}(\hat{J})$$

in  $\mathbb{P}^m$ . This is the main result in the elimination theory of varieties in  $\mathbb{P}^n \times \mathbb{P}^m$ . Hint:  $J$  also defines a variety in  $\mathbb{P}^n \times k^{m+1}$ , so that you can apply Theorem 6 to the projection  $\mathbb{P}^n \times k^{m+1} \rightarrow k^{m+1}$ .

- 17. For the two examples of maps between projective spaces given in the discussion preceding Theorem 12, compute defining equations for the images of the maps.
- 18. In Exercise 11 of §1, we considered the projective plane  $\mathbb{P}^2$ , with coordinates  $(x, y, z)$ , and the dual projective plane  $\mathbb{P}^{2\vee}$ , where  $(A, B, C) \in \mathbb{P}^{2\vee}$  corresponds to the projective line  $L$  defined by  $Ax + By + Cz = 0$  in  $\mathbb{P}^2$ . Show that the subset

$$\{(p, l) \in \mathbb{P}^2 \times \mathbb{P}^{2\vee} : p \in L\} \subset \mathbb{P}^2 \times \mathbb{P}^{2\vee}$$

is the variety defined by a bihomogeneous polynomial in  $k[x, y, z, A, B, C]$  of bidegree  $(1, 1)$ . Hint: See part (f) of Exercise 11 of §1.

## §6 The Geometry of Quadric Hypersurfaces

In this section, we will study quadric hypersurfaces in  $\mathbb{P}^n(k)$ . These varieties generalize conic sections in the plane and their geometry is quite interesting. To simplify notation, we will write  $\mathbb{P}^n$  rather than  $\mathbb{P}^n(k)$ , and we will use  $x_0, \dots, x_n$  as homogeneous

coordinates. Throughout this section, we will assume that  $k$  is a field not of characteristic 2. This means that  $2 = 1 + 1 \neq 0$  in  $k$ , so that in particular we can divide by 2.

Before introducing quadric hypersurfaces, we need to understand the notion of *projective equivalence*. Let  $\text{GL}(n+1, k)$  be the set of invertible  $(n+1) \times (n+1)$  matrices with entries in  $k$ . We can use elements  $A \in \text{GL}(n+1, k)$  to create transformations of  $\mathbb{P}^n$  as follows. Under matrix multiplication,  $A$  induces a linear map  $A : k^{n+1} \rightarrow k^{n+1}$  which is an isomorphism since  $A$  is invertible. This map takes subspaces of  $k^{n+1}$  to subspaces of the same dimension, and restricting to 1-dimensional subspaces, it follows that  $A$  takes a line through the origin to a line through the origin. Thus  $A$  induces a map  $A : \mathbb{P}^n \rightarrow \mathbb{P}^n$  [see (1) from §2]. We call such a map a *projective linear transformation*.

In terms of homogeneous coordinates, we can describe  $A : \mathbb{P}^n \rightarrow \mathbb{P}^n$  as follows. Suppose that  $A = (a_{ij})$ , where  $0 \leq i, j \leq n$ . If  $(b_0, \dots, b_n)$  are homogeneous coordinates of a point  $p \in \mathbb{P}^n$ , it follows by matrix multiplication that

$$(1) \quad A(p) = (a_{00}b_0 + \dots + a_{0n}b_n, \dots, a_{n0}b_0 + \dots + a_{nn}b_n)$$

are homogeneous coordinates for  $A(p)$ . This formula makes it easy to work with projective linear transformations. Note that  $A : \mathbb{P}^n \rightarrow \mathbb{P}^n$  is a bijection, and its inverse is given by the matrix  $A^{-1} \in \text{GL}(n+1, k)$ . In Exercise 1, you will study the set of all projective linear transformations in more detail.

Given a variety  $V \subset \mathbb{P}^n$  and an element  $A \in \text{GL}(n+1, k)$ , we can apply  $A$  to all points of  $V$  to get the subset  $A(V) = \{A(p) : p \in V\} \subset \mathbb{P}^n$ .

**Proposition 1.** *If  $A \in \text{GL}(n+1, k)$  and  $V \subset \mathbb{P}^n$  is a variety, then  $A(V) \subset \mathbb{P}^n$  is also a variety. We say that  $V$  and  $A(V)$  are **projectively equivalent**.*

**Proof.** Suppose that  $V = \mathbf{V}(f_1, \dots, f_s)$ , where each  $f_i$  is a homogeneous polynomial. Since  $A$  is invertible, it has an inverse matrix  $B = A^{-1}$ . Then for each  $i$ , let  $g_i = f_i \circ B$ . If  $B = (b_{ij})$ , this means

$$g_i(x_0, \dots, x_n) = f_i(b_{00}x_0 + \dots + b_{0n}x_n, \dots, b_{n0}x_0 + \dots + b_{nn}x_n).$$

It is easy to see that  $g_i$  is homogeneous of the same total degree as  $f_i$ , and we leave it as an exercise to show that

$$(2) \quad A(\mathbf{V}(f_1, \dots, f_s)) = \mathbf{V}(g_1, \dots, g_s).$$

This equality proves the proposition. □

We can regard  $A = (a_{ij})$  as transforming  $x_0, \dots, x_n$  into new coordinates  $X_0, \dots, X_n$  defined by

$$(3) \quad X_i = \sum_{j=0}^n a_{ij}x_j.$$

These give homogeneous coordinates on  $\mathbb{P}^n$  because  $A \in \text{GL}(n+1, k)$ . It follows from (1) that we can think of  $A(V)$  as the original  $V$  viewed using the new homogeneous coordinates  $X_0, \dots, X_n$ . An example of how this works will be given in Proposition 2.

In studying  $\mathbb{P}^n$ , an important goal is to classify varieties up to projective equivalence. In the exercises, you will show that projective equivalence is an equivalence relation. As an example of how this works, let us classify hyperplanes  $H \subset \mathbb{P}^n$  up to projective equivalence. Recall from §2 that a *hyperplane* is defined by a linear equation of the form

$$a_0x_0 + \cdots + a_nx_n = 0$$

where  $a_0, \dots, a_n$  are not all zero.

**Proposition 2.** *All hyperplanes  $H \subset \mathbb{P}^n$  are projectively equivalent.*

**Proof.** We will show that  $H$  is projectively equivalent to  $\mathbf{V}(x_0)$ . Since projective equivalence is an equivalence relation, this will prove the proposition.

Suppose that  $H$  is defined by  $f = a_0x_0 + \cdots + a_nx_n$ , and assume in addition that  $a_0 \neq 0$ . Now consider the new homogeneous coordinates

$$(4) \quad \begin{aligned} X_0 &= a_0x_0 + a_1x_1 + \cdots + a_nx_n, \\ X_1 &= x_1 \\ &\vdots \\ X_n &= x_n. \end{aligned}$$

Then it is easy to see that  $\mathbf{V}(f) = \mathbf{V}(X_0)$ .

Thus, in the  $X_0, \dots, X_n$  coordinate system,  $\mathbf{V}(f)$  is defined by the vanishing of the first coordinate. As explained in (3), this is the same as saying that  $\mathbf{V}(f)$  and  $\mathbf{V}(x_0)$  are projectively equivalent via the coefficient matrix

$$A = \begin{pmatrix} a_0 & a_1 & \cdots & a_n \\ 0 & 1 & \cdots & 0 \\ \vdots & \vdots & \ddots & \vdots \\ 0 & 0 & \cdots & 1 \end{pmatrix}$$

from (4). This is invertible since  $a_0 \neq 0$ . You should check that  $A(\mathbf{V}(f)) = \mathbf{V}(x_0)$ , so that we have the desired projective equivalence.

More generally, if  $a_i \neq 0$  in  $f$ , a similar argument shows that  $\mathbf{V}(f)$  is projectively equivalent to  $\mathbf{V}(x_i)$ . We leave it as an exercise to show that  $\mathbf{V}(x_i)$  is projectively equivalent to  $\mathbf{V}(x_0)$  for all  $i$ , and the proposition is proved.  $\square$

In §2, we observed that  $\mathbf{V}(x_0)$  can be regarded as a copy of the projective space  $\mathbb{P}^{n-1}$ . It follows from Proposition 2 that *all* hyperplanes in  $\mathbb{P}^n$  look like  $\mathbb{P}^{n-1}$ .

Now that we understand hyperplanes, we will study the next simplest case, hypersurfaces defined by a homogeneous polynomial of total degree 2.

**Definition 3.** *A variety  $V = \mathbf{V}(f) \subset \mathbb{P}^n$ , where  $f$  is a nonzero homogeneous polynomial of total degree 2, is called a **quadric hypersurface**, or more simply, a **quadric**.*

The simplest examples of quadrics come from analytic geometry. Recall that a conic section in  $\mathbb{R}^2$  is defined by an equation of the form

$$ax^2 + bxy + cy^2 + dx + ey + f = 0.$$

To get the projective closure in  $\mathbb{P}^2(\mathbb{R})$ , we homogenize with respect to  $z$  to get

$$ax^2 + bxy + cy^2 + dxz + eyz + fz^2 = 0,$$

which is homogeneous of total degree 2. For this reason, quadrics in  $\mathbb{P}^2$  are called *conics*.

We can classify quadrics up to projective equivalence as follows.

**Theorem 4 (Normal Form for Quadrics).** *Let  $f = \sum_{i,j=0}^n a_{ij}x_i x_j \in k[x_0, \dots, x_n]$  be a nonzero homogeneous polynomial of total degree 2, and assume that  $k$  is a field not of characteristic 2. Then  $\mathbf{V}(f)$  is projectively equivalent to a quadric defined by an equation of the form*

$$c_0x_0^2 + c_1x_1^2 + \dots + c_nx_n^2 = 0,$$

where  $c_0, \dots, c_n$  are elements of  $k$ , not all zero.

**Proof.** Our strategy will be to find a change of coordinates  $X_i = \sum_{j=0}^n b_{ij}x_j$  such that  $f$  has the form

$$c_0X_0^2 + c_1X_1^2 + \dots + c_nX_n^2.$$

As in Proposition 2, this will give the desired projective equivalence. Our proof will be an elementary application of completing the square.

We will use induction on the number of variables. For one variable, the theorem is trivial since  $a_{00}x_0^2$  is the only homogeneous polynomial of total degree 2. Now assume that the theorem is true when there are  $n$  variables.

Given  $f = \sum_{i,j=0}^n a_{ij}x_i x_j$ , we first claim that by a change of coordinates, we can assume  $a_{00} \neq 0$ . To see this, first suppose that  $a_{00} = 0$  and  $a_{jj} \neq 0$  for some  $1 \leq j \leq n$ . In this case, we set

$$(5) \quad X_0 = x_j, X_j = x_0, \quad \text{and} \quad X_i = x_i \quad \text{for} \quad i \neq 0, j.$$

Then the coefficient of  $X_0^2$  in the expansion of  $f$  in terms of  $X_0, \dots, X_n$  is nonzero. On the other hand, if all  $a_{ii} = 0$ , then since  $f \neq 0$ , we must have  $a_{ij} \neq -a_{ji}$  for some  $i \neq j$ . Making a change of variables as in (5), we may assume that  $a_{01} \neq -a_{10}$ . Now set

$$(6) \quad X_0 = x_0, X_1 = x_1 - x_0, \quad \text{and} \quad X_i = x_i \quad \text{for} \quad i \geq 2.$$

We leave it as an easy exercise to show that in terms of  $X_0, \dots, X_n$ , the polynomial  $f$  has the form  $\sum_{i,j=0}^n c_{ij}X_i X_j$  where  $c_{00} = a_{01} + a_{10} \neq 0$ . This establishes the claim.

Now suppose that  $f = \sum_{i,j=0}^n a_{ij}x_i x_j$  where  $a_{00} \neq 0$ . Let  $b_i = a_{i0} + a_{0i}$  and note that

$$\frac{1}{a_{00}} \left( a_{00}x_0 + \sum_{i=1}^n \frac{b_i}{2}x_i \right)^2 = a_{00}x_0^2 + \sum_{i=1}^n b_i x_0 x_i + \sum_{i,j=1}^n \frac{b_i b_j}{4a_{00}} x_i x_j.$$

Since the characteristic of  $k$  is not 2, we know that  $2 = 1 + 1 \neq 0$  and, thus, division by 2 is possible in  $k$ . Now we introduce new coordinates  $X_0, \dots, X_n$ , where

$$(7) \quad X_0 = x_0 + \frac{1}{a_{00}} \sum_{i=1}^n \frac{b_i}{2} x_i \quad \text{and} \quad X_i = x_i \quad \text{for} \quad i \geq 1.$$

Writing  $f$  in terms of  $X_0, \dots, X_n$ , all of the terms  $X_0 X_i$  cancel for  $1 \leq i \leq n$  and, hence, we get a sum of the form

$$a_{00} X_0^2 + \sum_{i,j=1}^n d_{ij} X_i X_j.$$

The sum  $\sum_{i,j=1}^n d_{ij} X_i X_j$  involves the  $n$  variables  $X_1, \dots, X_n$ , so that by our inductive assumption, we can find a change of coordinates (only involving  $X_1, \dots, X_n$ ) which transforms  $\sum_{i,j=1}^n d_{ij} X_i X_j$  into  $e_1 X_1^2 + \dots + e_n X_n^2$ . We can regard this as a coordinate change for  $X_0, X_1, \dots, X_n$  which leaves  $X_0$  fixed. Then we have a coordinate change that transforms  $a_{00} X_0^2 + \sum_{i,j=1}^n d_{ij} X_i X_j$  into the desired form. This completes the proof of the theorem.  $\square$

In the normal form  $c_0 x_0^2 + \dots + c_n x_n^2$  given by Theorem 4, some of the coefficients  $c_i$  may be zero. By relabeling coordinates, we may assume that  $c_i \neq 0$  if  $0 \leq i \leq p$  and  $c_i = 0$  for  $i > p$ . Then the quadric is projectively equivalent to one given by the equation

$$(8) \quad c_0 x_0^2 + \dots + c_p x_p^2 = 0, \quad c_0, \dots, c_p \text{ nonzero.}$$

There is a special name for the number of nonzero coefficients.

**Definition 5.** Let  $V \subset \mathbb{P}^n$  be a quadric hypersurface.

- (i) If  $V$  is defined by an equation of the form (8), then  $V$  has **rank**  $p + 1$ .
- (ii) More generally, if  $V$  is an arbitrary quadric, then  $V$  has **rank**  $p + 1$  if  $V$  is projectively equivalent to a quadric defined by an equation of the form (8).

For example, suppose we use homogeneous coordinates  $(x, y, z)$  in  $\mathbb{P}^2(\mathbb{R})$ . Then the three conics defined by

$$x^2 + y^2 - z^2 = 0, \quad x^2 - z^2 = 0, \quad x^2 = 0$$

have ranks 3, 2 and 1, respectively. The first conic is the projective version of the circle, whereas the second is the union of two projective lines  $\mathbf{V}(x - z) \cup \mathbf{V}(x + z)$ , and the third is the projective line  $\mathbf{V}(x)$ , which we regard as a degenerate conic of multiplicity two. (In general, we can regard any rank 1 quadric as a hyperplane of multiplicity two.)

In the second part of Definition 5, we need to show that the rank is well-defined. Given a quadric  $V$ , this means showing that for all projectively equivalent quadrics defined by an equation of the form (8), the number of nonzero coefficients is always the same. We will prove this by computing the rank directly from the defining polynomial  $f = \sum_{i,j=0}^n a_{ij} x_i x_j$  of  $V$ .

A first observation is that we can assume  $a_{ij} = a_{ji}$  for all  $i, j$ . This follows by setting  $b_{ij} = (a_{ij} + a_{ji})/2$  (remember that  $k$  has characteristic different from 2). An easy computation shows that  $f = \sum_{i,j=0}^n b_{ij}x_i x_j$ , and our claim follows since  $b_{ij} = b_{ji}$ .

A second observation is that we can use matrix multiplication to represent  $f$ . The coefficients of  $f$  form an  $(n+1) \times (n+1)$  matrix  $Q = (a_{ij})$ , which we will assume to be symmetric by our first observation. Let  $\mathbf{x}$  be the column vector with entries  $x_0, \dots, x_n$ . We leave it as an exercise to show

$$f(\mathbf{x}) = \mathbf{x}^t Q \mathbf{x},$$

where  $\mathbf{x}^t$  is the transpose of  $\mathbf{x}$ .

We can compute the rank of  $\mathbf{V}(f)$  in terms of  $Q$  as follows.

**Proposition 6.** *Let  $f = \mathbf{x}^t Q \mathbf{x}$ , where  $Q$  is an  $(n + 1) \times (n + 1)$  symmetric matrix.*

(i) *Given an element  $A \in \text{GL}(n + 1, k)$ , let  $B = A^{-1}$ . Then*

$$A(\mathbf{V}(f)) = \mathbf{V}(g).$$

where  $g(\mathbf{x}) = \mathbf{x}^t B^t Q B \mathbf{x}$ .

(ii) *The rank of the quadric hypersurface  $\mathbf{V}(f)$  equals the rank of the matrix  $Q$ .*

**Proof.** To prove (i), we note from (2) that  $A(\mathbf{V}(f)) = \mathbf{V}(g)$ , where  $g = f \circ B$ . We compute  $g$  as follows:

$$g(\mathbf{x}) = f(B\mathbf{x}) = (B\mathbf{x})^t Q (B\mathbf{x}) = \mathbf{x}^t B^t Q B \mathbf{x},$$

where we have used the fact that  $(UV)^t = V^t U^t$  for all matrices  $U, V$  such that  $UV$  is defined. This completes the proof of (i).

To prove (ii), first note that  $Q$  and  $B^t Q B$  have the same rank. This follows since multiplying a matrix on the right or left by an invertible matrix does not change the rank [see Theorem 4.12 from FINKBEINER (1978)].

Now suppose we have used Theorem 4 to find a matrix  $A \in \text{GL}(n + 1, k)$  such that  $g = c_0 x_0^2 + \dots + c_p x_p^2$  with  $c_0, \dots, c_p$  nonzero. The matrix of  $g$  is a diagonal matrix with  $c_0, \dots, c_p$  on the main diagonal. If we combine this with part (i), we see that

$$B^t Q B = \begin{pmatrix} c_0 & & & & & \\ & \ddots & & & & \\ & & c_p & & & \\ & & & 0 & & \\ & & & & \ddots & \\ & & & & & 0 \end{pmatrix},$$

where  $B = A^{-1}$ . The rank of a matrix is the maximum number of linearly independent columns and it follows that  $B^t Q B$  has rank  $p + 1$ . The above observation then implies that  $Q$  also has rank  $p + 1$ , as desired. □

When  $k$  is an algebraically closed field (such as  $k = \mathbb{C}$ ), Theorem 4 and Proposition 6 show that quadrics are completely classified by their rank.

**Proposition 7.** *If  $k$  is algebraically closed (and not of characteristic 2), then a quadric hypersurface of rank  $p + 1$  is projectively equivalent to the quadric defined by the equation*

$$\sum_{i=0}^p x_i^2 = 0.$$

*In particular, two quadrics are projectively equivalent if and only if they have the same rank.*

**Proof.** By Theorem 4, we can assume that we have a quadric defined by a polynomial of the form  $c_0x_0^2 + \cdots + c_px_p^2 = 0$ , where  $p + 1$  is the rank. Since  $k$  is algebraically closed, the equation  $x^2 - c_i = 0$  has a root in  $k$ . Pick a root and call it  $\sqrt{c_i}$ . Note that  $\sqrt{c_i} \neq 0$  since  $c_i$  is nonzero. Then set

$$\begin{aligned} X_i &= \sqrt{c_i}x_i, & 0 \leq i \leq p, \\ X_i &= x_i, & p < i \leq n. \end{aligned}$$

This gives the desired form and it follows that quadrics of the same rank are projectively equivalent. To prove the converse, suppose that  $\mathbf{V}(f)$  and  $\mathbf{V}(g)$  are projectively equivalent. By Proposition 6, we can assume that  $f$  and  $g$  have matrices  $Q$  and  $B^tQB$ , respectively, where  $B$  is invertible. As noted in the proof of Proposition 6,  $Q$  and  $B^tQB$  have the same rank, which implies the same for the quadrics  $\mathbf{V}(f)$  and  $\mathbf{V}(g)$ .  $\square$

Over the real numbers, the rank is not the only invariant of a quadric hypersurface. For example, in  $\mathbb{P}^2(\mathbb{R})$ , the conics  $V_1 = \mathbf{V}(x^2 + y^2 + z^2)$  and  $V_2 = \mathbf{V}(x^2 + y^2 - z^2)$  have rank 3 but cannot be projectively equivalent since  $V_1$  is empty, yet  $V_2$  is not. In the exercises, you will show given any quadric  $\mathbf{V}(f)$  with coefficients in  $\mathbb{R}$ , there are integers  $r \geq -1$  and  $s \geq 0$  with  $0 \leq r + s \leq n$  such that  $\mathbf{V}(f)$  is projectively equivalent over  $\mathbb{R}$  to a quadric of the form

$$x_0^2 + \cdots + x_r^2 - x_{r+1}^2 - \cdots - x_{r+s}^2 = 0.$$

(The case  $r = -1$  corresponds to when all of the signs are negative.)

We are most interested in quadrics of maximal rank in  $\mathbb{P}^n$ .

**Definition 8.** *A quadric hypersurface in  $\mathbb{P}^n$  is **nonsingular** if it has rank  $n + 1$ .*

A nonsingular quadric is defined by an equation  $f = \mathbf{x}^tQ\mathbf{x} = 0$  where  $Q$  has rank  $n + 1$ . Since  $Q$  is an  $(n + 1) \times (n + 1)$  matrix, this is equivalent to  $Q$  being invertible. An immediate consequence of Proposition 7 is the following.

**Corollary 9.** *Let  $k$  be an algebraically closed field. Then all nonsingular quadrics in  $\mathbb{P}^n$  are projectively equivalent.*

In the exercises, you will show that a quadric in  $\mathbb{P}^n$  of rank  $p + 1$  can be represented as the join of a nonsingular quadric in  $\mathbb{P}^p$  with a copy of  $\mathbb{P}^{n-p-1}$ . Thus, we can understand all quadrics once we know the nonsingular ones.

For the remainder of the section, we will discuss some interesting properties of nonsingular quadrics in  $\mathbb{P}^2$ ,  $\mathbb{P}^3$ , and  $\mathbb{P}^5$ . For the case of  $\mathbb{P}^2$ , consider the mapping  $F : \mathbb{P}^1 \rightarrow \mathbb{P}^2$  defined by

$$F(u, v) = (u^2, uv, v^2),$$

where  $(u, v)$  are homogeneous coordinates on  $\mathbb{P}^1$ . Using elimination theory, it is easy to see that the image of  $F$  is contained in the nonsingular conic  $\mathbf{V}(x_0x_2 - x_1^2)$ . In fact, the map  $F : \mathbb{P}^1 \rightarrow \mathbf{V}(x_0x_2 - x_1^2)$  is a bijection (see Exercise 11), so that this conic looks like a copy of  $\mathbb{P}^1$ . When  $k$  is algebraically closed, it follows that *all* nonsingular conics in  $\mathbb{P}^2$  look like  $\mathbb{P}^1$ .

When we move to quadrics in  $\mathbb{P}^3$ , the situation is more interesting. Consider the mapping

$$\sigma : \mathbb{P}^1 \times \mathbb{P}^1 \rightarrow \mathbb{P}^3$$

which takes a point  $(x_0, x_1, y_0, y_1) \in \mathbb{P}^1 \times \mathbb{P}^1$  to the point  $(x_0y_0, x_0y_1, x_1y_0, x_1y_1) \in \mathbb{P}^3$ . This map is called a *Segre map* and its properties were studied in Exercise 14 of §4. For us, the important fact is that the image of  $\sigma$  is a nonsingular quadric.

**Proposition 10.** *The Segre map  $\sigma : \mathbb{P}^1 \times \mathbb{P}^1 \rightarrow \mathbb{P}^3$  is one-to-one and its image is the nonsingular quadric  $\mathbf{V}(z_0z_3 - z_1z_2)$ .*

**Proof.** We will use  $(z_0, z_1, z_2, z_3)$  as homogeneous coordinates on  $\mathbb{P}^3$ . If we eliminate  $x_0, x_1, y_0, y_1$  from the equations

$$\begin{aligned} x_0y_0 &= z_0, \\ x_0y_1 &= z_1, \\ x_1y_0 &= z_2, \\ x_1y_1 &= z_3, \end{aligned}$$

then it follows easily that

$$(9) \quad \sigma(\mathbb{P}^1 \times \mathbb{P}^1) \subset \mathbf{V}(z_0z_3 - z_1z_2).$$

To prove equality, suppose that  $(w_0, w_1, w_2, w_3) \in \mathbf{V}(z_0z_3 - z_1z_2)$ . If  $w_0 \neq 0$ , then  $(w_0, w_2, w_0, w_1) \in \mathbb{P}^1 \times \mathbb{P}^1$  and

$$\sigma(w_0, w_2, w_0, w_1) = (w_0^2, w_0w_1, w_0w_2, w_1w_2).$$

However, since  $w_0w_3 - w_1w_2 = 0$ , we can write this as

$$\sigma(w_0, w_2, w_0, w_1) = (w_0^2, w_0w_1, w_0w_2, w_0w_3) = (w_0, w_1, w_2, w_3).$$

When a different coordinate is nonzero, the proof is similar and it follows that (9) is an equality. The above argument can be adapted to show that  $\sigma$  is one-to-one (we leave



the details as an exercise) and it is also easy to see that  $\mathbf{V}(z_0z_3 - z_1z_2)$  is nonsingular. This proves the proposition.  $\square$

Proposition 10 has some nice consequences concerning lines on the quadric surface  $\mathbf{V}(z_0z_3 - z_1z_2) \subset \mathbb{P}^3$ . But before we can discuss this, we need to learn how to describe projective lines in  $\mathbb{P}^3$ .

Two points  $p \neq q$  in  $\mathbb{P}^3$  give linearly independent vectors  $p = (a_0, a_1, a_2, a_3)$  and  $q = (b_0, b_1, b_2, b_3)$  in  $k^4$ . Now consider the map  $F : \mathbb{P}^1 \rightarrow \mathbb{P}^3$  given by

$$(10) \quad F(u, v) = (a_0u - b_0v, a_1u - b_1v, a_2u - b_2v, a_3u - b_3v).$$

Since  $p$  and  $q$  are linearly independent,  $a_0u - b_0v, \dots, a_3u - b_3v$  cannot vanish simultaneously, so that  $F$  is defined on all of  $\mathbb{P}^1$ . In Exercise 13, you will show that the image of  $F$  is a variety  $L \subset \mathbb{P}^3$  defined by linear equations. We call  $L$  the *projective line* (or more simply, the *line*) determined by  $p$  and  $q$ . Note that  $L$  contains both  $p$  and  $q$ . In the exercises, you will show that all lines in  $\mathbb{P}^3$  are projectively equivalent and that they can be regarded as copies of  $\mathbb{P}^1$  sitting inside  $\mathbb{P}^3$ .

Using the Segre map  $\sigma$ , we can identify the quadric  $V = \mathbf{V}(z_0z_3 - z_1z_2) \subset \mathbb{P}^3$  with  $\mathbb{P}^1 \times \mathbb{P}^1$ . If we fix  $b = (b_0, b_1) \in \mathbb{P}^1$ , the image in  $V$  of  $\mathbb{P}^1 \times \{b\}$  under  $\sigma$  consists of the points  $(ub_0, ub_1, vb_0, vb_1)$  as  $(u, v)$  ranges over  $\mathbb{P}^1$ . By (10), this is the projective line through the points  $(b_0, b_1, 0, 0)$  and  $(0, 0, b_0, b_1)$ . Hence,  $b \in \mathbb{P}^1$  determines a line  $L_b$  lying on the quadric  $V$ . If  $b \neq b'$ , one can easily show that  $L_b$  does not intersect  $L_{b'}$  and that every point on  $V$  lies on a unique such line. Thus,  $V$  is swept out by the family  $\{L_b : b \in \mathbb{P}^1\}$  of nonintersecting lines. Such a surface is called a *ruled surface*. In the exercises, you will show that  $\{\sigma(\{a\} \times \mathbb{P}^1) : a \in \mathbb{P}^1\}$  is a second family of lines that sweeps out  $V$ . If we look at  $V$  in the affine space where  $z_0 = 1$ , then  $V$  is defined by  $z_3 = z_1z_2$ , and we get the following graph:

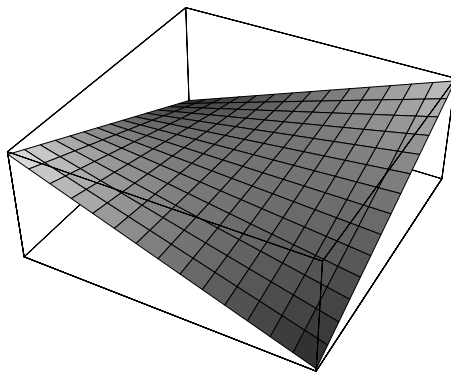

The two families of lines on  $V$  are clearly visible in the above picture. Over an algebraically closed field, Corollary 9 implies that all nonsingular quadrics in  $\mathbb{P}^3$  look like this (up to projective equivalence). Over the real numbers, however, there are more possibilities.

For our final example, we will show that the problem of describing lines in  $\mathbb{P}^3$  leads to an interesting quadric in  $\mathbb{P}^5$ . To motivate what follows, let us first recall the situation of lines in  $\mathbb{P}^2$ . Here, a line  $L \subset \mathbb{P}^2$  is defined by a single equation  $A_0x_0 + A_1x_1 + A_2x_2 = 0$ . In Exercise 11 of §1, we showed that  $(A_0, A_1, A_2)$  can be regarded as the “homogeneous coordinates” of  $L$  and that the set of all lines forms the dual projective space  $\mathbb{P}^{2\vee}$ .

It makes sense to ask the same questions for  $\mathbb{P}^3$ . In particular, can we find “homogeneous coordinates” for lines in  $\mathbb{P}^3$ ? We saw earlier that a line  $L \subset \mathbb{P}^3$  can be projectively parametrized using two points  $p, q \in L$ . This is a good start, but there are infinitely many such pairs on  $L$ . How do we get something unique out of this? The idea is the following. Suppose that  $p = (a_0, a_1, a_2, a_3)$  and  $q = (b_0, b_1, b_2, b_3)$  in  $k^4$ . Then consider the  $2 \times 4$  matrix whose rows are  $p$  and  $q$ :

$$\Omega = \begin{pmatrix} a_0 & a_1 & a_2 & a_3 \\ b_0 & b_1 & b_2 & b_3 \end{pmatrix}.$$

We will create coordinates for  $L$  using the determinants of  $2 \times 2$  submatrices of  $\Omega$ . If we number the columns of  $\Omega$  using  $0, 1, 2, 3$ , then the determinant formed using columns  $i$  and  $j$  will be denoted  $w_{ij}$ . We can assume  $0 \leq i < j \leq 3$ , and we get the six determinants

$$(11) \quad \begin{aligned} w_{01} &= a_0b_1 - a_1b_0, \\ w_{02} &= a_0b_2 - a_2b_0, \\ w_{03} &= a_0b_3 - a_3b_0, \\ w_{12} &= a_1b_2 - a_2b_1, \\ w_{13} &= a_1b_3 - a_3b_1, \\ w_{23} &= a_2b_3 - a_3b_2. \end{aligned}$$

We will encode them in the 6-tuple.

$$\omega(p, q) = (w_{01}, w_{02}, w_{03}, w_{12}, w_{13}, w_{23}) \in k^6.$$

The  $w_{ij}$  are called the *Plücker coordinates* of the line  $L$ . A first observation is that any line has at least one nonzero Plücker coordinate. To see why, note that  $\Omega$  has row rank 2 since  $p$  and  $q$  are linearly independent. Hence the column rank is also 2, so that there must be two linearly independent columns. These columns give a nonzero Plücker coordinate.

To see how the Plücker coordinates depend on the chosen points  $p, q \in L$ , suppose that we pick a different pair  $p', q' \in L$ . By (10), we see that in terms of homogeneous coordinates,  $L$  can be described as the set

$$L = \{up - vq : (u, v) \in \mathbb{P}^1\}.$$

In particular, we can write

$$\begin{aligned} p' &= up - vq, \\ q' &= sp - tq \end{aligned}$$

for distinct points  $(u, v), (s, t) \in \mathbb{P}^1$ . We leave it as an exercise to show that

$$\omega(p', q') = \omega(up - vq, sp - tq) = (vs - ut)\omega(p, q)$$

in  $k^6$ . Further, it is easy to see that  $vs - ut \neq 0$  since  $(u, v) \neq (s, t)$  in  $\mathbb{P}^1$ . This shows that  $\omega(p, q)$  gives us a point in  $\mathbb{P}^5$  which depends *only* on  $L$ . Hence, a line  $L$  determines a well-defined point  $\omega(L) \in \mathbb{P}^5$ .

As we vary  $L$  over all lines in  $\mathbb{P}^3$ , the Plücker coordinates  $\omega(L)$  will describe a certain subset of  $\mathbb{P}^5$ . By eliminating the  $a_i$ 's and  $b_i$ 's, from (11), it is easy to see that  $w_{01}w_{23} - w_{02}w_{13} + w_{03}w_{12} = 0$  for all sets of Plücker coordinates. If we let  $z_{ij}, 0 \leq i < j \leq 3$ , be homogeneous coordinates on  $\mathbb{P}^5$ , it follows that the points  $\omega(L)$  all lie in the nonsingular quadric  $\mathbf{V}(z_{01}z_{23} - z_{02}z_{13} + z_{03}z_{12}) \subset \mathbb{P}^5$ . Let us prove that this quadric is *exactly* the set of lines in  $\mathbb{P}^3$ .

**Theorem 11.** *The map*

$$\{\text{lines in } \mathbb{P}^3\} \rightarrow \mathbf{V}(z_{01}z_{23} - z_{02}z_{13} + z_{03}z_{12})$$

which sends a line  $L \subset \mathbb{P}^3$  to its Plücker coordinates  $\omega(L) \in \mathbf{V}(z_{01}z_{23} - z_{02}z_{13} + z_{03}z_{12})$  is a bijection.

**Proof.** The strategy of the proof is to show that a line  $L \subset \mathbb{P}^3$  can be reconstructed from its Plücker coordinates. Given two points  $p = (a_0, a_1, a_2, a_3)$  and  $q = (b_0, b_1, b_2, b_3)$  on  $L$ , it is easy to check that we get the following four vectors in  $k^4$ :

$$(12) \quad \begin{aligned} b_0p - a_0q &= (0, -w_{01}, -w_{02}, -w_{03}), \\ b_1p - a_1q &= (w_{01}, 0, -w_{12}, -w_{13}), \\ b_2p - a_2q &= (w_{02}, w_{12}, 0, -w_{23}), \\ b_3p - a_3q &= (w_{03}, w_{13}, w_{23}, 0). \end{aligned}$$

It may happen that some of these vectors are 0, but whenever they are nonzero, it follows from (10) that they give points of  $L$ .

To prove that  $\omega$  is one-to-one, suppose that we have lines  $L$  and  $L'$  such that  $\omega(L) = \lambda\omega(L')$  for some nonzero  $\lambda$ . In terms of Plücker coordinates, this means that  $w_{ij} = \lambda w'_{ij}$  for all  $0 \leq i < j \leq 3$ . We know that some Plücker coordinate of  $L$  is nonzero, and by permuting the coordinates in  $\mathbb{P}^3$ , we can assume  $w_{01} \neq 0$ . Then (12) implies that in  $\mathbb{P}^3$ , the points

$$\begin{aligned} P &= (0, -w'_{01}, -w'_{02}, -w'_{03}) = (0, -\lambda w_{01}, -\lambda w_{02}, -\lambda w_{03}) \\ &= (0, -w_{01}, -w_{02}, -w_{03}), \\ Q &= (w'_{01}, 0, -w'_{12}, -w'_{13}) = (\lambda w_{01}, 0, -\lambda w_{12}, -\lambda w_{13}) \\ &= (w_{01}, 0, -w_{12}, -w_{13}) \end{aligned}$$

lie on both  $L$  and  $L'$ . Since there is a unique line through two points in  $\mathbb{P}^3$  (see Exercise 14), it follows that  $L = L'$ . This proves that our map is one-to-one.

To see that  $\omega$  is onto, pick a point

$$(w_{01}, w_{02}, w_{03}, w_{12}, w_{13}, w_{23}) \in \mathbf{V}(z_{01}z_{23} - z_{02}z_{13} + z_{03}z_{12}).$$

By changing coordinates in  $\mathbb{P}^3$ , we can assume  $w_{01} \neq 0$ . Then the first two vectors in (12) are nonzero and, hence, determine a line  $L \subset \mathbb{P}^3$ . Using the definition of  $\omega(L)$  and the relation  $w_{01}w_{23} - w_{02}w_{13} + w_{03}w_{12} = 0$ , it is straightforward to show that the

$w_{ij}$  are the Plücker coordinates of  $L$  (see Exercise 16 for the details). This shows that  $\omega$  is onto and completes the proof of the theorem.  $\square$

A nice consequence of Theorem 11 is that the set of lines in  $\mathbb{P}^3$  can be given the structure of a projective variety. As we observed at the end of Chapter 7, an important idea in algebraic geometry is that any set of geometrically interesting objects should form a variety in some natural way.

Theorem 11 can be generalized in many ways. One can study lines in  $\mathbb{P}^n$ , and it is even possible to define Plücker coordinates for linear varieties in  $\mathbb{P}^n$  of arbitrary dimension. This leads to the study of what are called *Grassmannians*. Using Plücker coordinates, a Grassmannian can be given the structure of a projective variety, although there is usually more than one defining equation. See Exercise 17 for the case of lines in  $\mathbb{P}^4$ .

We can also think of Theorem 11 from an affine point of view. We already know that there is a natural bijection

$$\{\text{lines through the origin in } k^4\} \cong \{\text{points in } \mathbb{P}^3\},$$

and in the exercises, you will describe a bijection

$$\{\text{planes through the origin in } k^4\} \cong \{\text{lines in } \mathbb{P}^3\}.$$

Thus, Theorem 11 shows that planes through the origin in  $k^4$  have the structure of a quadric hypersurface in  $\mathbb{P}^5$ . In the exercises, you will see that this has a surprising connection with reduced row echelon matrices. More generally, the Grassmannians mentioned in the previous paragraph can be described in terms of subspaces of a certain dimension in affine space  $k^{n+1}$ .

This completes our discussion of quadric hypersurfaces, but by no means exhausts the subject. The classic books by ROTH and SEMPLE (1949) and HODGE and PEDOE (1968) contain a wealth of material on quadric hypersurfaces (and many other interesting projective varieties as well).

**EXERCISES FOR §6**

1. The set  $GL(n + 1, k)$  is closed under inverses and matrix multiplication and is a group in the terminology of Appendix A. In the text, we observed that  $A \in GL(n + 1, k)$  induces a projective linear transformation  $A : \mathbb{P}^n \rightarrow \mathbb{P}^n$ . To describe the set of all such transformations, we define a relation on  $GL(n + 1, k)$  by

$$A' \sim A \iff A' = \lambda A \quad \text{for some } \lambda \neq 0.$$

- a. Prove that  $\sim$  is an equivalence relation. The set of equivalence classes for  $\sim$  is denoted  $PGL(n + 1, k)$ .
- b. Show that if  $A \sim A'$  and  $B \sim B'$ , then  $AB \sim A'B'$ . Hence, the matrix product operation is well-defined on the equivalence classes for  $\sim$  and, thus,  $PGL(n + 1, k)$  has the structure of a group. We call  $PGL(n + 1, k)$  the *projective linear group*.
- c. Show that two matrices  $A, A' \in GL(n + 1, k)$  define the same mapping  $\mathbb{P}^n \rightarrow \mathbb{P}^n$  if and only if  $A' \sim A$ . It follows that we can regard  $PGL(n + 1, k)$  as a set of invertible transformations on  $\mathbb{P}^n$ .

2. Prove equation (2) in the proof of Proposition 1.
3. Prove that projective equivalence is an equivalence relation on the set of projective varieties in  $\mathbb{P}^n$ .
4. Prove that the hyperplanes  $\mathbf{V}(x_i)$  and  $\mathbf{V}(x_0)$  are projectively equivalent. Hint: See (5).
5. This exercise is concerned with the proof of Theorem 4.
  - a. If  $f = \sum_{i,j=0}^n a_{ij}x_ix_j$  has  $a_{01} \neq -a_{10}$  and  $a_{ii} = 0$  for all  $i$ , prove that the change of coordinates (6) transforms  $f$  into  $\sum_{i,j=0}^n c_{ij}X_iX_j$  where  $c_{00} = a_{01} + a_{10}$ .
  - b. If  $f = \sum_{i,j=0}^n a_{ij}x_ix_j$  has  $a_{00} \neq 0$ , verify that the change of coordinates (7) transforms  $f$  into  $a_{00}X_0^2 + \sum_{i,j=1}^n d_{ij}X_iX_j$ .
6. If  $f = \sum_{i,j=0}^n a_{ij}x_ix_j$ , let  $Q$  be the  $(n+1) \times (n+1)$  matrix  $(a_{ij})$ .

- a. Show that  $f(\mathbf{x}) = \mathbf{x}^t Q \mathbf{x}$ .
- b. Suppose that  $k$  has characteristic 2 (e.g.,  $k = \mathbb{F}_2$ ), and let  $f = x_0x_1$ . Show that there is no symmetric  $2 \times 2$  matrix  $Q$  with entries in  $k$  such that  $f(\mathbf{x}) = \mathbf{x}^t Q \mathbf{x}$ .

7. Use the proofs of Theorem 4 and Proposition 7 to write each of the following as a sum of squares. Assume that  $k = \mathbb{C}$ .

- a.  $x_0x_1 + x_0x_2 + x_2^2$ .
- b.  $x_0^2 + 4x_1x_3 + 2x_2x_3 + x_4^2$ .
- c.  $x_0x_1 + x_2x_3 - x_4x_5$ .

8. Given a nonzero polynomial  $f = \sum_{i,j=0}^n a_{ij}x_ix_j$  with coefficients in  $\mathbb{R}$ , show that there are integers  $r \geq -1$  and  $s \geq 0$  with  $0 \leq r+s \leq n$  such that  $f$  can be brought to the form

$$x_0^2 + \cdots + x_r^2 - x_{r+1}^2 - \cdots - x_{r+s}^2$$

by a suitable coordinate change with real coefficients. One can prove that the integers  $r$  and  $s$  are uniquely determined by  $f$ .

9. Let  $f = \sum_{i,j=0}^n a_{ij}x_ix_j \in k[x_0, \dots, x_n]$  be nonzero. In the text, we observed that  $\mathbf{V}(f)$  is a nonsingular quadric if and only if  $\det(a_{ij}) \neq 0$ . We say that  $\mathbf{V}(f)$  is *singular* if it is not nonsingular. In this exercise, we will explore a nice way to characterize singular quadrics.

- a. Show that  $f$  is singular if and only if there exists a point  $a \in \mathbb{P}^n$  with homogeneous coordinates  $(a_0, \dots, a_n)$  such that

$$\frac{\partial f}{\partial x_0}(a) = \cdots = \frac{\partial f}{\partial x_n}(a) = 0.$$

- b. If  $a \in \mathbb{P}^n$  has the property described in part (a), prove that  $a \in \mathbf{V}(f)$ . In general, a point  $a$  of a hypersurface  $\mathbf{V}(f)$  (quadric or of higher degree) is called a *singular point* of  $\mathbf{V}(f)$  provided that all of the partial derivatives of  $f$  vanish at  $a$ . Hint: Use Exercise 17 of §2.

10. Let  $\mathbf{V}(f) \subset \mathbb{P}^n$  be a quadric of rank  $p+1$ , where  $0 < p < n$ . Prove that there are  $X, Y \subset \mathbb{P}^n$  such that (1)  $X \simeq \mathbf{V}(g) \subset \mathbb{P}^p$  for some nonsingular quadric  $g$ , (2)  $Y \simeq \mathbb{P}^{n-p-1}$ , (3)  $X \cap Y = \emptyset$ , and (4)  $\mathbf{V}(f)$  is the *join*  $X * Y$ , which is defined to be the set of all lines in  $\mathbb{P}^n$  connecting a point of  $X$  to a point of  $Y$  (and if  $X = \emptyset$ , we set  $X * Y = Y$ ). Hint: Use Theorem 4.

11. We will study the map  $F : \mathbb{P}^1 \rightarrow \mathbb{P}^2$  defined by  $F(u, v) = (u^2, uv, v^2)$ .
  - a. Use elimination theory to prove that the image of  $F$  lies in  $\mathbf{V}(x_0x_2 - x_1^2)$ .
  - b. Prove that  $F : \mathbb{P}^1 \rightarrow \mathbf{V}(x_0x_2 - x_1^2)$  is a bijection. Hint: Adapt the methods used in the proof of Proposition 10.

12. This exercise will study the Segre map  $\sigma : \mathbb{P}^1 \times \mathbb{P}^1 \rightarrow \mathbb{P}^3$  defined in the text.
  - a. Use elimination theory to prove that the image of  $\sigma$  lies in the quadric  $\mathbf{V}(z_0z_3 - z_1z_2)$ .
  - b. Use the hint given in the text to prove that  $\sigma$  is one-to-one.

13. In this exercise and the next, we will work out some basic facts about lines in  $\mathbb{P}^n$ . We start with two distinct points  $p, q \in \mathbb{P}^n$ , which we will think of as linearly independent vectors in  $k^{n+1}$ .

- a. We can define a map  $F : \mathbb{P}^1 \rightarrow \mathbb{P}^n$  by  $F(u, v) = up - vq$ . Show that this map is defined on all of  $\mathbb{P}^1$  and is one-to-one.
  - b. Let  $\ell = a_0x_0 + \cdots + a_nx_n$  be a linear homogeneous polynomial. Show that  $\ell$  vanishes on the image of  $F$  if and only if  $p, q \in \mathbf{V}(\ell)$ .
  - c. Our goal is to show that the image of  $F$  is a variety defined by linear equations. Let  $\Omega$  be the  $2 \times (n + 1)$  matrix whose rows are  $p$  and  $q$ . Note that  $\Omega$  has rank 2. If we multiply column vectors in  $k^{n+1}$  by  $\Omega$ , we get a linear map  $\Omega : k^{n+1} \rightarrow k^2$ . Use results from linear algebra to show that the kernel (or nullspace) of this linear map has dimension  $n - 1$ . Pick a basis  $v_1, \dots, v_{n-1}$  of the kernel, and let  $\ell_i$  be the linear polynomial whose coefficients are the entries of  $v_i$ . Then prove that the image of  $F$  is  $\mathbf{V}(\ell_1, \dots, \ell_{n-1})$ .  
Hint: Study the subspace of  $k^{n+1}$  defined by the equations  $\ell_1 = \cdots = \ell_{n-1} = 0$ .
14. The exercise will discuss some elementary properties of lines in  $\mathbb{P}^n$ .
- a. Given points  $p \neq q$  in  $\mathbb{P}^n$ , prove that there is a unique line through  $p$  and  $q$ .
  - b. If  $L$  is a line in  $\mathbb{P}^n$  and  $U_i \cong k^n$  is the affine space where  $x_i = 1$ , then show that  $L \cap U_i$ , is either empty or a line in  $k^n$  in the usual sense.
  - c. Show that all lines in  $\mathbb{P}^n$  are projectively equivalent. Hint: In part (c) of Exercise 13, you showed that a line  $L$  can be written  $L = \mathbf{V}(\ell_1, \dots, \ell_{n-1})$ . Show that you can find  $\ell_n$  and  $\ell_{n+1}$  so that  $X_0 = \ell_1, \dots, X_n = \ell_{n+1}$  is a change of coordinates. What does  $L$  look like in the new coordinate system?
15. Let  $\sigma : \mathbb{P}^1 \times \mathbb{P}^1 \rightarrow \mathbb{P}^3$  be the Segre map.
- a. Show that  $L'_a = \sigma(\{a\} \times \mathbb{P}^1)$  is a line in  $\mathbb{P}^3$ .
  - b. Show that every point of  $\mathbf{V}(z_0z_3 - z_1z_2)$  lies on a unique line  $L'_a$ . This proves that the family of lines  $\{L'_a : a \in \mathbb{P}^1\}$  sweeps out the quadric.
16. This exercise will deal with the proof of Theorem 11.
- a. Prove that  $\omega(up - vq, sp - tq) = (vs - ut)\omega(p, q)$ . Hint: if  $\begin{pmatrix} p \\ q \end{pmatrix}$  is the  $2 \times 4$  matrix with rows  $p$  and  $q$ , show that

$$\begin{pmatrix} up - vq \\ sp - tq \end{pmatrix} = \begin{pmatrix} u - v \\ s - t \end{pmatrix} \begin{pmatrix} p \\ q \end{pmatrix}.$$

- b. Apply elimination theory to (11) to show that Plücker coordinates satisfy the relation  $w_{01}w_{23} - w_{02}w_{13} + w_{03}w_{12} = 0$ .
  - c. Complete the proof of Theorem 11 by showing that the map  $\omega$  is onto.
17. In this exercise, we will study Plücker coordinates for lines in  $\mathbb{P}^4$
- a. Let  $L \subset \mathbb{P}^4$  be a line. Using the homogeneous coordinates of two points  $p, q \in L$ , define Plücker coordinates and show that we get a point  $\omega(L) \in \mathbb{P}^9$  that depends only on  $L$ .
  - b. Find the relations between the Plücker coordinates and use these to find a variety  $V \subset \mathbb{P}^9$  such that  $\omega(L) \in V$  for all lines  $L$ .
  - c. Show that the map sending a line  $L \subset \mathbb{P}^4$  to  $\omega(L) \in V$  is a bijection.
18. Show that there is a one-to-one correspondence between lines in  $\mathbb{P}^3$  and planes through the origin in  $k^4$ . This explains why a line in  $\mathbb{P}^3$  is different from a line in  $k^3$  or  $k^4$ .
19. There is a nice connection between lines in  $\mathbb{P}^3$  and  $2 \times 4$  reduced row echelon matrices of rank 2. Let  $V = \mathbf{V}(z_0z_{23} - z_{02}z_{13} + z_{03}z_{12})$  be the quadric of Theorem 11.
- a. Show that there is a one-to-one correspondence between reduced row echelon matrices of the form

$$\begin{pmatrix} 1 & 0 & a & b \\ 0 & 1 & c & d \end{pmatrix}$$

and points in the affine portion  $V \cap U_{01}$ , where  $U_{01}$  is the affine space in  $\mathbb{P}^5$  defined by  $z_{01} = 1$ . Hint: The rows of the above matrix determine a line in  $\mathbb{P}^3$ . What are its Plücker coordinates?

- b. The matrices given in part (a) do not exhaust all possible  $2 \times 4$  reduced row echelon matrices of rank 2. For example, we also have the matrices

$$\begin{pmatrix} 1 & a & 0 & b \\ 0 & 0 & 1 & c \end{pmatrix}.$$

Show that there is a one-to-one correspondence between these matrices and points of  $V \cap \mathbf{V}(z_{01}) \cap U_{02}$ .

- c. Show that there are four remaining types of  $2 \times 4$  reduced row echelon matrices of rank 2 and prove that each of these is in a one-to-one correspondence with a certain portion of  $V$ . Hint: The columns containing the leading 1's will correspond to a certain Plücker coordinate being 1.
- d. Explain directly (without using  $V$  or Plücker coordinates) why  $2 \times 4$  reduced row echelon matrices of rank 2 should correspond uniquely to lines in  $\mathbb{P}^3$ . Hint: See Exercise 18.

## §7 Bezout's Theorem

This section will explore what happens when two curves intersect in the plane. We are particularly interested in the *number* of points of intersection. The following examples illustrate why the answer is especially nice when we work with curves in  $\mathbb{P}^2(\mathbb{C})$ , the projective plane over the complex numbers. We will also see that we need to define the *multiplicity* of a point of intersection. Fortunately, the resultants we learned about in Chapter 3 will make this relatively easy to do.

**Example 1.** First consider the intersection of a parabola and an ellipse. To allow for explicit calculations, suppose the parabola is  $y = x^2$  and the ellipse is  $x^2 + 4(y - \lambda)^2 = 4$ , where  $\lambda$  is a parameter we can vary. For example, when  $\lambda = 2$  or 0, we get the pictures:

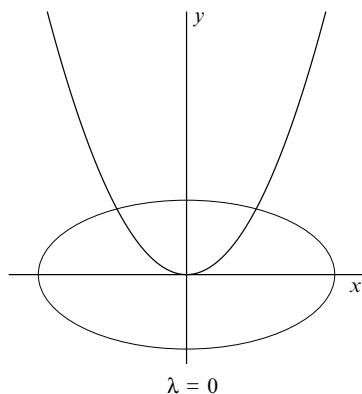
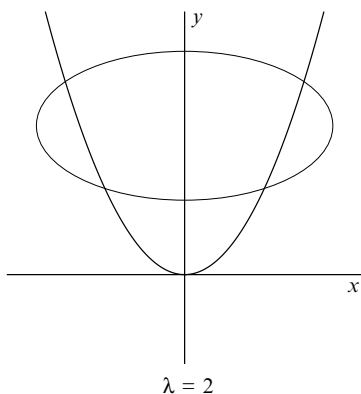

Over  $\mathbb{R}$ , we get different numbers of intersections, and it is clear that there are values of  $\lambda$  for which there are *no* points of intersection (see Exercise 1). What is more interesting is that over  $\mathbb{C}$ , we have four points of intersection in *both* of the above cases. For example, when  $\lambda = 0$ , we can eliminate  $x$  from  $y = x^2$  and  $x^2 + 4y^2 = 4$  to obtain  $y + 4y^2 = 4$ , which has roots

$$y = \frac{-1 \pm \sqrt{65}}{8},$$

and the corresponding values of  $x$  are

$$x = \pm \sqrt{\frac{-1 \pm \sqrt{65}}{8}}.$$

This gives four points of intersection, two real and two complex (since  $-1 - \sqrt{65} < 0$ ). You can also check that when  $\lambda = 2$ , working over  $\mathbb{C}$  gives no new solutions beyond the four we see in the above picture (see Exercise 1).

Hence, the number of intersections seems to be more predictable when we work over the complex numbers. As confirmation, you can check that in the cases where there are no points of intersection over  $\mathbb{R}$ , we still get four points over  $\mathbb{C}$  (see Exercise 1).

However, even over  $\mathbb{C}$ , some unexpected things can happen. For example, suppose we intersect the parabola with the ellipse where  $\lambda = 1$ :

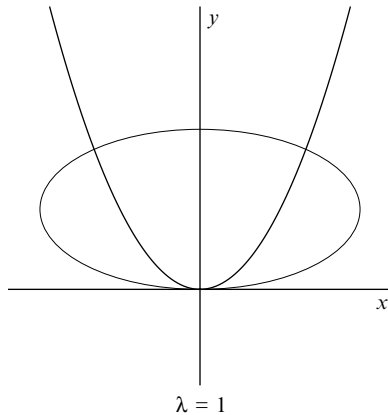

Here, we see only three points of intersection, and this remains true over  $\mathbb{C}$ . But the origin is clearly a “special” type of intersection since the two curves are tangent at this point. As we will see later, this intersection has *multiplicity two*, while the other two intersections have *multiplicity one*. If we add up the multiplicities of the points of intersection, we still get four.

**Example 2.** Now consider the intersection of our parabola  $y = x^2$  with a line  $L$ . It is easy to see that in most cases, this leads to two points of intersection over  $\mathbb{C}$ , provided



multiplicities are counted properly (see Exercise 2). However, if we intersect with a *vertical* line, then we get the following picture:

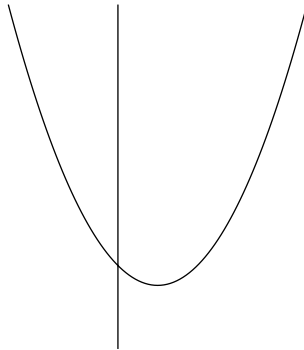

There is just one point of intersection, and since multiplicities seem to involve tangency, it should be an intersection of multiplicity one. Yet we want the answer to be two, since this is what we get in the other cases. Where is the other point of intersection?

If we change our point of view and work in the projective plane  $\mathbb{P}^2(\mathbb{C})$ , the above question is easy to answer: the missing point is “at infinity.” To see why, let  $z$  be the third variable. Then we homogenize  $y = x^2$  to get the projective equation  $yz = x^2$ , and a vertical line  $x = c$  gives the projective line  $x = cz$ . Eliminating  $x$ , we get  $yz = c^2z^2$ , which is easily solved to obtain  $(x, y, z) = (c, c^2, 1)$  or  $(0, 1, 0)$  (remember that these are homogeneous coordinates). The first lies in the affine part (where  $z = 1$ ) and is the point we see in the above picture, while the second is on the line at infinity (where  $z = 0$ ).

**Example 3.** In  $\mathbb{P}^2(\mathbb{C})$ , consider the two curves given by  $C = \mathbf{V}(x^2 - z^2)$  and  $D = \mathbf{V}(x^2y - xz^2 - xyz + z^3)$ . It is easy to check that  $(1, b, 1) \in C \cap D$  for any  $b \in \mathbb{C}$ , so that the intersection  $C \cap D$  is infinite! To see how this could have happened, consider the factorizations

$$x^2 - z^2 = (x - z)(x + z), \quad x^2y - xz^2 - xyz + z^3 = (x - z)(xy - z^2).$$

Thus,  $C$  is a union of two projective lines and  $D$  is the union of a line and a conic. In fact, these are the irreducible components of  $C$  and  $D$  in the sense of §3 (see Proposition 4 below). We now see where the problem occurred:  $C$  and  $D$  have a common irreducible component  $\mathbf{V}(x - z)$ , so of course their intersection is infinite.

These examples explain why we want to work in  $\mathbb{P}^2(\mathbb{C})$ . Hence, for the rest of the section, we will use  $\mathbb{C}$  and write  $\mathbb{P}^2$  instead of  $\mathbb{P}^2(\mathbb{C})$ . In this context, a *curve* is a projective variety  $\mathbf{V}(f)$  defined by a nonzero homogeneous polynomial  $f \in \mathbb{C}[x, y, z]$ . Our examples also indicate that we should pay attention to multiplicities of intersections and irreducible components of curves. We begin by studying irreducible components.

**Proposition 4.** *Let  $f \in \mathbb{C}[x, y, z]$  be a nonzero homogeneous polynomial. Then the irreducible factors of  $f$  are also homogeneous, and if we factor  $f$  into irreducibles:*

$$f = f_1^{a_1} \cdots f_s^{a_s},$$

where  $f_i$  is not a constant multiple of  $f_j$  for  $i \neq j$ , then

$$\mathbf{V}(f) = \mathbf{V}(f_1) \cup \cdots \cup \mathbf{V}(f_s)$$

is the minimal decomposition of  $\mathbf{V}(f)$  into irreducible components in  $\mathbb{P}^2$ . Furthermore,

$$\mathbf{I}(\mathbf{V}(f)) = \sqrt{\langle f \rangle} = \langle f_1 \cdots f_s \rangle.$$

**Proof.** First, suppose that  $f$  factors as  $f = gh$  for some polynomials  $g, h \in \mathbb{C}[x, y, z]$ . We claim that  $g$  and  $h$  must be homogeneous since  $f$  is. To prove this, write  $g = g_m + \cdots + g_0$ , where  $g_i$  is homogeneous of total degree  $i$  and  $g_m \neq 0$ . Similarly let  $h = h_n + \cdots + h_0$ . Then

$$\begin{aligned} f = gh &= (g_m + \cdots + g_0)(h_n + \cdots + h_0) \\ &= g_m h_n + \text{terms of lower total degree.} \end{aligned}$$

Since  $f$  is homogeneous, we must have  $f = g_m h_n$ , and with a little more argument, one can conclude that  $g = g_m$  and  $h = h_n$  (see Exercise 3). Thus  $g$  and  $h$  are homogeneous. From here, it follows easily that the irreducible factors  $f$  are also homogeneous.

Now suppose  $f$  factors as above. Then  $\mathbf{V}(f) = \mathbf{V}(f_1) \cup \cdots \cup \mathbf{V}(f_s)$  follows immediately, and this is the minimal decomposition into irreducible components by the projective version of Exercise 9 from Chapter 4, §6. Since  $\mathbf{V}(f)$  is nonempty (see Exercise 6), the assertion about  $\mathbf{I}(\mathbf{V}(f))$  follows from the Projective Nullstellensatz and Proposition 9 of Chapter 4, §2.  $\square$

A consequence of Proposition 4 is that every curve  $C \subset \mathbb{P}^2$  has a “best” defining equation. If  $C = \mathbf{V}(f)$  for some homogeneous polynomial  $f$ , then the proposition implies that  $\mathbf{I}(C) = \langle f_1 \cdots f_s \rangle$ , where  $f_1, \dots, f_s$  are distinct irreducible factors of  $f$ . Thus, any other polynomial defining  $C$  is a multiple of  $f_1 \cdots f_s$ , so that  $f_1 \cdots f_s = 0$  is the defining equation of smallest total degree. In the language of Chapter 4, §2,  $f_1 \cdots f_s$  is a reduced (or square-free) polynomial. Hence, we call  $f_1 \cdots f_s = 0$  the *reduced equation* of  $C$ . This equation is unique up to multiplication by a nonzero constant.

When we consider the intersection of two curves  $C$  and  $D$  in  $\mathbb{P}^2$ , we will assume that  $C$  and  $D$  have no common irreducible components. This means that their defining polynomials have no common factors. Our goal is to relate the number of points in  $C \cap D$  to the degrees of their reduced equations. The following property of resultants will play an important role in our study of this problem.

**Lemma 5.** *Let  $f, g \in \mathbb{C}[x, y, z]$  be homogeneous of total degree  $m, n$  respectively. If  $f(0, 0, 1)$  and  $g(0, 0, 1)$  are nonzero, then the resultant  $\text{Res}(f, g, z)$  is homogeneous in  $x$  and  $y$  of total degree  $mn$ .*

**Proof.** First, write  $f$  and  $g$  as polynomials in  $z$ :

$$f = a_0z^m + \cdots + a_m,$$

$$g = b_0z^n + \cdots + b_n,$$

and observe that since  $f$  is homogeneous of total degree  $m$ , each  $a_i \in \mathbb{C}[x, y]$  must be homogeneous of degree  $i$ . Furthermore,  $f(0, 0, 1) \neq 0$  implies that  $a_0$  is a nonzero constant. Similarly,  $b_i$  is homogeneous of degree  $i$  and  $b_0 \neq 0$ .

By Chapter 3, §5, the resultant is given by the  $(m + n) \times (m + n)$ -determinant

$$\text{Res}(f, g, z) = \det \begin{pmatrix} a_0 & & & & b_0 & & & & \\ \vdots & & & & \vdots & & & & \\ a_m & & & a_0 & b_n & & & b_0 & \\ & & & \vdots & & & & \vdots & \\ & & & & & & & \vdots & \\ & & & & & & & & b_n \end{pmatrix}$$

$\underbrace{\hspace{10em}}_{n \text{ columns}} \quad \underbrace{\hspace{10em}}_{m \text{ columns}}$

where the empty spaces are filled by zeros. To show that  $\text{Res}(f, g, z)$  is homogeneous of degree  $mn$ , let  $c_{ij}$  denote the  $ij$ -th entry of the matrix. From the pattern of the above matrix, you can check that the nonzero entries are

$$c_{ij} = \begin{cases} a_{i-j} & \text{if } j \leq n \\ b_{n+i-j} & \text{if } j > n. \end{cases}$$

Thus, a nonzero  $c_{ij}$  is homogeneous of total degree  $i - j$  (if  $j \leq n$ ) or  $n + i - j$  (if  $j > n$ ).

By Proposition 2 of Appendix A, §3, the determinant giving  $\text{Res}(f, g, z)$  is a sum of products

$$\pm \prod_{i=1}^{m+n} c_{i\sigma(i)},$$

where  $\sigma$  is a permutation of  $\{1, \dots, m + n\}$ . We can assume that each  $c_{i\sigma(i)}$  in the product is nonzero. If we write the product as

$$\pm \prod_{\sigma(i) \leq n} c_{i\sigma(i)} \prod_{\sigma(i) > n} c_{i\sigma(i)},$$

then, by the above paragraph, this product is a homogeneous polynomial of degree

$$\sum_{\sigma(i) \leq n} (i - \sigma(i)) + \sum_{\sigma(i) > n} (n + i - \sigma(i)).$$

Since  $\sigma$  is a permutation of  $\{1, \dots, m + n\}$ , the first sum has  $n$  terms and the second has  $m$ , and all  $i$ 's between 1 and  $m + n$  appear exactly once. Thus, we can rearrange the sum to obtain

$$mn + \sum_{i=1}^{m+n} i - \sum_{i=1}^{m+n} \sigma(i) = mn,$$

which proves that  $\text{Res}(f, g, z)$  is a sum of homogeneous polynomials of degree  $mn$ .  $\square$

This lemma shows that the resultant  $\text{Res}(f, g, z)$  is homogeneous in  $x$  and  $y$ . In general, homogeneous polynomials in two variables have an especially simple structure.

**Lemma 6.** *Let  $h \in \mathbb{C}[x, y]$  be a nonzero homogeneous polynomial. Then  $h$  can be written in the form*

$$h = c(s_1x - r_1y)^{m_1} \cdots (s_t x - r_t y)^{m_t},$$

where  $c \neq 0$  in  $\mathbb{C}$  and  $(r_1, s_1), \dots, (r_t, s_t)$  are distinct points of  $\mathbb{P}^1$ . Furthermore,

$$\mathbf{V}(h) = \{(r_1, s_1), \dots, (r_t, s_t)\} \subset \mathbb{P}^1.$$

**Proof.** This follows by observing that the polynomial  $h(x, 1) \in \mathbb{C}[x]$  is a product of linear factors since  $\mathbb{C}$  is algebraically closed. We leave the details as an exercise.  $\square$

As a first application of these lemmas, we show how to bound the number of points in the intersection of two curves using the degrees of their reduced equations.

**Theorem 7.** *Let  $C$  and  $D$  be projective curves in  $\mathbb{P}^2$  with no common irreducible components. If the degrees of the reduced equations for  $C$  and  $D$  are  $m$  and  $n$  respectively, then  $C \cap D$  is finite and has at most  $mn$  points.*

**Proof.** Suppose that  $C \cap D$  has more than  $mn$  points. Choose  $mn + 1$  of them, which we label  $p_1, \dots, p_{mn+1}$ , and for  $1 \leq i < j \leq mn + 1$ , let  $L_{ij}$  be the line through  $p_i$  and  $p_j$ . Then pick a point  $q \in \mathbb{P}^2$  such that

$$(1) \quad q \notin C \cup D \cup \bigcup_{i < j} L_{ij}$$

(in Exercise 6 you will prove carefully that such points exist).

As in §6, a matrix  $A \in \text{GL}(3, \mathbb{C})$  gives a map  $A : \mathbb{P}^2 \rightarrow \mathbb{P}^2$ . It is easy to find an  $A$  such that  $A(q) = (0, 0, 1)$  (see Exercise 6). If we regard  $A$  as giving new coordinates for  $\mathbb{P}^2$  (see (3) in §6), then the point  $q$  has coordinates  $(0, 0, 1)$  in the new system. We can thus assume that  $q = (0, 0, 1)$  in (1).

Now suppose that  $C = \mathbf{V}(f)$  and  $D = \mathbf{V}(g)$ , where  $f$  and  $g$  are reduced of degrees  $m$  and  $n$  respectively. Then (1) implies  $f(0, 0, 1) \neq 0$  since  $(0, 0, 1) \notin C$ , and  $g(0, 0, 1) \neq 0$  follows similarly. Thus, by Lemma 5, the resultant  $\text{Res}(f, g, z)$  is a homogeneous polynomial of degree  $mn$  in  $x, y$ . Since  $f$  and  $g$  have positive degree in  $z$  and have no common factors in  $\mathbb{C}[x, y, z]$ , Proposition 1 of Chapter 3, §6, shows that  $\text{Res}(f, g, z)$  is nonzero.

If we let  $p_i = (u_i, v_i, w_i)$ , then since the resultant is in the ideal generated by  $f$  and  $g$  (Proposition 1 of Chapter 3, §6), we have

$$(2) \quad \text{Res}(f, g, z)(u_i, v_i) = 0.$$

Note that the line connecting  $q = (0, 0, 1)$  to  $p_i = (u_i, v_i, w_i)$  intersects  $z = 0$  in the point  $(u_i, v_i, 0)$  (see Exercise 6). The picture is as follows:

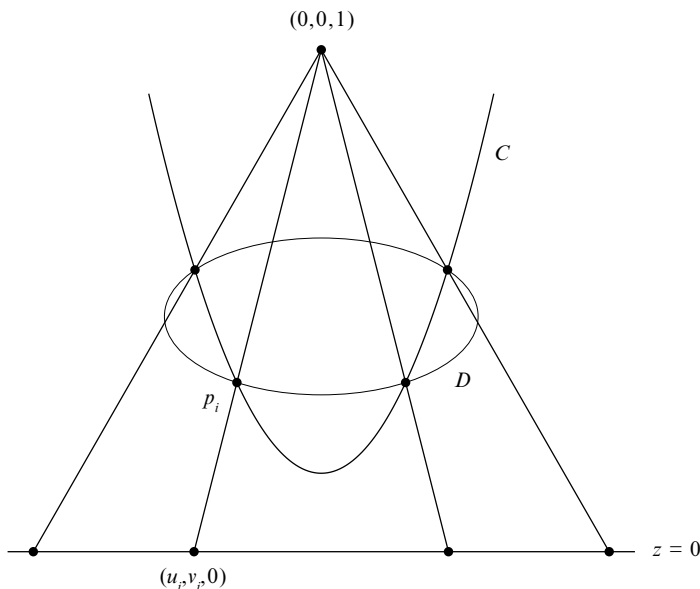

The map taking a point  $(u, v, w) \in \mathbb{P}^2 - \{(0, 0, 1)\}$  to  $(u, v, 0)$  is an example of a *projection from a point to a line*. Hence, (2) tells us that  $\text{Res}(f, g, z)$  vanishes at the points obtained by projecting the  $p_i \in C \cap D$  from  $(0, 0, 1)$  to the line  $z = 0$ .

By (1),  $(0, 0, 1)$  lies on none of the lines connecting  $p_i$  and  $p_j$ , which implies that the points  $(u_i, v_i, 0)$  are distinct for  $i = 1, \dots, mn + 1$ . If we regard  $z = 0$  as a copy of  $\mathbb{P}^1$  with homogeneous coordinates  $x, y$ , then we get distinct points  $(u_i, v_i) \in \mathbb{P}^1$ , and the homogeneous polynomial  $\text{Res}(f, g, z)$  vanishes at all  $mn + 1$  of them. By Lemmas 5 and 6, this is impossible since  $\text{Res}(f, g, z)$  is nonzero of degree  $mn$ , and the theorem follows.  $\square$

Now that we have a criterion for  $C \cap D$  to be finite, the next step is to define an *intersection multiplicity* for each point  $p \in C \cap D$ . There are a variety of ways this can be done, but the simplest involves the resultant.

Thus, we define the intersection multiplicity as follows. Let  $C$  and  $D$  be curves in  $\mathbb{P}^2$  with no common components and reduced equations  $f = 0$  and  $g = 0$ . For each pair of points  $p \neq q$  in  $C \cap D$ , let  $L_{pq}$  be the projective line connecting  $p$  and  $q$ . Pick a matrix  $A \in \text{GL}(3, \mathbb{C})$  such that in the new coordinate system given by  $A$ , we have

$$(3) \quad (0, 0, 1) \notin C \cup D \cup \bigcup_{p \neq q \text{ in } C \cap D} L_{pq}.$$

(Example 9 below shows how such coordinate changes are done.) As in the proof of Theorem 7, if  $p = (u, v, w) \in C \cap D$ , then the resultant  $\text{Res}(f, g, z)$  vanishes at  $(u, v)$ , so that by Lemma 6,  $vx - uy$  is a factor of  $\text{Res}(f, g, z)$ .

**Definition 8.** Let  $C$  and  $D$  be curves in  $\mathbb{P}^2$  with no common components and reduced defining equations  $f = 0$  and  $g = 0$ . Choose coordinates for  $\mathbb{P}^2$  so that (3) is satisfied. Then, given  $p = (u, v, w) \in C \cap D$ , the **intersection multiplicity**  $I_p(C, D)$  is defined to be the exponent of  $v x - u y$  in the factorization of  $\text{Res}(f, g, z)$ .

In order for  $I_p(C, D)$  to be well-defined, we need to make sure that we get the same answer no matter what coordinate system satisfying (3) we use in Definition 8. For the moment, we will assume this is true and compute some examples of intersection multiplicities.

**Example 9.** Consider the following polynomials in  $\mathbb{C}[x, y, z]$ :

$$\begin{aligned} f &= x^3 + y^3 - 2xyz, \\ g &= 2x^3 - 4x^2y + 3xy^2 + y^3 - 2y^2z. \end{aligned}$$

These polynomials [adapted from WALKER (1950)] define cubic curves  $C = \mathbf{V}(f)$  and  $D = \mathbf{V}(g)$  in  $\mathbb{P}^2$ . To study their intersection, we first compute the resultant with respect to  $z$ :

$$\text{Res}(f, g, z) = -2y(x - y)^3(2x + y).$$

Since the resultant is in the elimination ideal, points in  $C \cap D$  satisfy either  $y = 0$ ,  $x - y = 0$  or  $2x + y = 0$ , and from here, it is easy to show that  $C \cap D$  consists of the three points

$$p = (0, 0, 1), \quad q = (1, 1, 1), \quad r = (4/7, -8/7, 1)$$

(see Exercise 7). In particular, this shows that  $C$  and  $D$  have no common components.

However, the above resultant does *not* give the correct intersection multiplicities since  $(0, 0, 1) \in C$  (in fact, it is a point of intersection). Hence, we must change coordinates. Start with a point such as

$$(0, 1, 0) \notin C \cup D \cup L_{pq} \cup L_{pr} \cup L_{qr},$$

and find a coordinate change with  $A(0, 1, 0) = (0, 0, 1)$ , say  $A(x, y, z) = (z, x, y)$ . Then

$$(0, 0, 1) \notin A(C) \cup A(D) \cup L_{A(p)A(q)} \cup L_{A(p)A(r)} \cup L_{A(q)A(r)}.$$

To find the defining equation of  $A(C)$ , note that

$$(u, v, w) \in A(C) \iff A^{-1}(u, v, w) \in C \iff f(A^{-1}(u, v, w)) = 0.$$

Thus,  $A(C)$  is defined by the equation  $f \circ A^{-1}(x, y, z) = f(y, z, x) = 0$ , and similarly,  $A(D)$  is given by  $g(y, z, x) = 0$ . Then, by Definition 8, the resultant  $\text{Res}(f(y, z, x), g(y, z, x), z)$  gives the multiplicities for  $A(p) = (1, 0, 0)$ ,  $A(q) = (1, 1, 1)$  and  $A(r) = (1, 4/7, -8/7)$ . The resultant is

$$\text{Res}(f(y, z, x), g(y, z, x), z) = 8y^5(x - y)^3(4x - 7y).$$

so that in terms of  $p$ ,  $q$  and  $r$ , the intersection multiplicities are

$$I_p(C, D) = 5, \quad I_q(C, D) = 3, \quad I_r(C, D) = 1.$$

**Example 1.** [continued] If we let  $\lambda = 1$  in Example 1, we get the curves

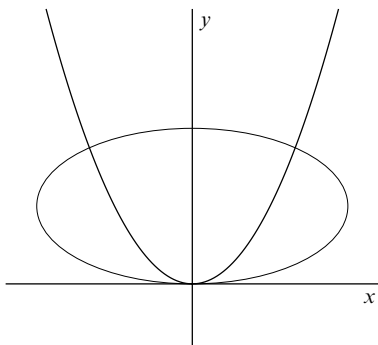

In this picture, the point  $(0, 0, 1)$  is the origin, so we again must change coordinates before (3) can hold. In the exercises, you will use an appropriate coordinate change to show that the intersection multiplicity at the origin is in fact equal to 2.

Still assuming that the intersection multiplicities in Definition 8 are well-defined, we can now prove Bezout's Theorem.

**Theorem 10 (Bezout's Theorem).** *Let  $C$  and  $D$  be curves in  $\mathbb{P}^2$  with no common components, and let  $m$  and  $n$  be the degrees of their reduced defining equations. Then*

$$\sum_{p \in C \cap D} I_p(C, D) = mn,$$

where  $I_p(C, D)$  is the intersection multiplicity at  $p$ , as defined in Definition 8.

**Proof.** Let  $f = 0$  and  $g = 0$  be the reduced equations of  $C$  and  $D$ , and assume that coordinates have been chosen so that (3) holds. Write  $p \in C \cap D$  as  $p = (u_p, v_p, w_p)$ . Then we claim that

$$\text{Res}(f, g, z) = c \prod_{p \in C \cap D} (v_p x - u_p y)^{I_p(C, D)},$$

where  $c$  is a nonzero constant. For each  $p$ , it is clear that  $(v_p x - u_p y)^{I_p(C, D)}$  is the exact power of  $v_p x - u_p y$  dividing the resultant—this follows by the definition of  $I_p(C, D)$ . We still need to check that this accounts for *all* roots of the resultant. But if  $(u, v) \in \mathbb{P}^1$  satisfies  $\text{Res}(f, g, z)(u, v) = 0$ , then Proposition 3 of Chapter 3, §6, implies that there is some  $w \in \mathbb{C}$  such that  $f$  and  $g$  vanish at  $(u, v, w)$ . This is because if we write  $f$  and  $g$  as in the proof of Lemma 5,  $a_0$  and  $b_0$  are nonzero constants by (3). Thus  $(u, v, w) \in C \cap D$ , and our claim is proved.

By Lemma 5,  $\text{Res}(f, g, z)$  is a nonzero homogeneous polynomial of degree  $mn$ . Then Bezout's Theorem follows by comparing the degree of each side in the above equation.  $\square$

**Example 9.** [continued] In Example 9, we had two cubic curves which intersected in the points  $(0, 0, 1)$ ,  $(1, 1, 1)$  and  $(4/7, -8/7, 1)$  of multiplicity 5, 3 and 1 respectively. These add up to  $9 = 3 \cdot 3$ , as desired. If you look back at Example 9, you'll see why we needed to change coordinates in order to compute intersection multiplicities. In the original coordinates,  $\text{Res}(f, g, z) = -2y(x - y)^3(2x + y)$ , which would give multiplicities 1, 3 and 1. Even without computing the correct multiplicities, we know these can't be right since they don't add up to 9!

Finally, we show that the intersection multiplicities in Definition 8 are well-defined.

**Lemma 11.** *In Definition 8, all coordinate change matrices satisfying (3) give the same intersection multiplicities  $I_p(C, D)$  for  $p \in C \cap D$ .*

**Proof.** Although this result holds over any algebraically closed field, our proof will use continuity arguments and hence is special to  $\mathbb{C}$ . We begin by describing carefully the coordinate changes we will use. As in Example 9, pick a point

$$r \notin C \cup D \cup \bigcup_{p \neq q \text{ in } C \cap D} L_{pq}$$

and a matrix  $A \in \text{GL}(3, \mathbb{C})$  such that  $A(r) = (0, 0, 1)$ . This means  $A^{-1}(0, 0, 1) = r$ , so that the condition on  $A$  is

$$A^{-1}(0, 0, 1) \notin C \cup D \cup \bigcup_{p \neq q \text{ in } C \cap D} L_{pq}.$$

Let  $l_{pq} = 0$  be the equation of the line  $L_{pq}$ , and set

$$h = f \cdot g \cdot \prod_{p \neq q \text{ in } C \cap D} \ell_{pq}.$$

The condition on  $A$  is thus  $A^{-1}(0, 0, 1) \notin \mathbf{V}(h)$ , i.e.,  $h(A^{-1}(0, 0, 1)) \neq 0$ .

We can formulate this problem without using matrix inverses as follows. Consider matrices  $B \in M_{3 \times 3}(\mathbb{C})$ , where  $M_{3 \times 3}(\mathbb{C})$  is the set of all  $3 \times 3$  matrices with entries in  $\mathbb{C}$ , and define the function  $H : M_{3 \times 3}(\mathbb{C}) \rightarrow \mathbb{C}$  by

$$H(B) = \det(B) \cdot h(B(0, 0, 1)).$$

If  $B = (b_{ij})$ , note that  $H(B)$  is a polynomial in the  $b_{ij}$ . Since a matrix is invertible if and only if its determinant is nonzero, we have

$$H(B) \neq 0 \iff B \text{ is invertible and } h(B(0, 0, 1)) \neq 0.$$

Hence the coordinate changes we want are given by  $A = B^{-1}$  for  $B \in M_{3 \times 3}(\mathbb{C}) - \mathbf{V}(H)$ .



Let  $C \cap D = \{p_1, \dots, p_s\}$ , and for each  $B \in M_{3 \times 3}(\mathbb{C}) - \mathbf{V}(H)$ , let  $B^{-1}(p_i) = (u_{i,B}, v_{i,B}, w_{i,B})$ . Then, by the argument given in Theorem 10, we can write

$$(4) \quad \text{Res}(f \circ B, g \circ B, z) = c_B (v_{1,B}x - u_{1,B}y)^{m_{1,B}} \cdots (v_{s,B}x - u_{s,B}y)^{m_{s,B}},$$

where  $c_B \neq 0$ . This means  $I_{p_i}(C, D) = m_{i,B}$  in the coordinate change given by  $A = B^{-1}$ . Thus, to prove the lemma, we need to show that  $m_{i,B}$  takes the same value for all  $B \in M_{3 \times 3}(\mathbb{C}) - \mathbf{V}(H)$ .

To study the exponents  $m_{i,B}$ , we consider what happens in general when we have a factorization

$$G(x, y) = (vx - uy)^m H(x, y)$$

where  $G$  and  $H$  are homogeneous and  $(u, v) \neq (0, 0)$ . Here, one calculates that

$$(5) \quad \frac{\partial^{i+j} G}{\partial x^i \partial y^j}(u, v) = \begin{cases} 0 & \text{if } 0 \leq i + j < m \\ m! v^i (-u)^j H(u, v) & \text{if } i + j = m, \end{cases}$$

(see Exercise 9). In particular, if  $H(u, v) \neq 0$ , then  $(u, v) \neq (0, 0)$  implies that some  $m$ th partial of  $G$  doesn't vanish at  $(u, v)$ .

We also need a method for measuring the distance between matrices  $B, C \in M_{3 \times 3}(\mathbb{C})$ . If  $B = (b_{ij})$  and  $C = (c_{ij})$ , then the distance between  $B$  and  $C$  is defined to be

$$d(B, C) = \sqrt{\sum_{i,j=1}^3 |b_{ij} - c_{ij}|^2},$$

where for a complex number  $z = a + ib$ ,  $|z| = \sqrt{a^2 + b^2}$ . A crucial fact is that any polynomial function  $F : M_{3 \times 3}(\mathbb{C}) \rightarrow \mathbb{C}$  is continuous. This means that given  $B_0 \in M_{3 \times 3}(\mathbb{C})$ , we can get  $F(B)$  arbitrarily close to  $F(B_0)$  by taking  $B$  sufficiently close to  $B_0$  (as measured by the above distance function). In particular, if  $F(B_0) \neq 0$ , it follows that  $F(B) \neq 0$  for  $B$  sufficiently close to  $B_0$ .

Now consider the exponent  $m = m_{i,B_0}$  for fixed  $B_0$  and  $i$ . We claim that  $m_{i,B} \leq m$  if  $B$  is sufficiently close to  $B_0$ . To see this, first note that (4) and (5) imply that some  $m$ th partial of  $\text{Res}(f \circ B_0, g \circ B_0, z)$  is nonzero at  $(u_{i,B_0}, v_{i,B_0})$ . If we write out  $(u_{i,B}, v_{i,B})$  and this partial derivative of  $\text{Res}(f \circ B, g \circ B, z)$  explicitly, we get formulas which are rational functions with numerators that are polynomials in the entries of  $B$  and denominators that are powers of  $\det(B)$ . Thus this  $m$ -th partial of  $\text{Res}(f \circ B, g \circ B, z)$ , when evaluated at  $(u_{i,B}, v_{i,B})$ , is a rational function of the same form. Since it is nonzero at  $B_0$ , the continuity argument from the previous paragraph shows that this  $m$ -th partial of  $\text{Res}(f \circ B, g \circ B, z)$  is nonzero at  $(u_{i,B}, v_{i,B})$ , once  $B$  is sufficiently close to  $B_0$ . But then, applying (4) and (5) to  $\text{Res}(f \circ B, g \circ B, z)$ , we conclude that  $m_{i,B} \leq m$  [since  $m_{i,B} > m$  would imply that all  $m$ -th partials would vanish at  $(u_{i,B}, v_{i,B})$ ].

However, if we sum the inequalities  $m_{i,B} \leq m = m_{i,B_0}$  for  $i = 1, \dots, s$ , we obtain

$$mn = \sum_{i=1}^s m_{i,B} \leq \sum_{i=1}^s m_{i,B_0} = mn.$$

This implies that we must have term-by-term equalities, so that  $m_{i,B} = m_{i,B_0}$  when  $B$  is sufficiently close to  $B_0$ .

This proves that the function sending  $B$  to  $m_{i,B}$  is *locally constant*, i.e., its value at a given point is the same as the values at nearby points. In order for us to conclude that the function is actually constant on all of  $M_{3 \times 3}(\mathbb{C}) - \mathbf{V}(H)$ , we need to prove that  $M_{3 \times 3}(\mathbb{C}) - \mathbf{V}(H)$  is *path connected*. This will be done in Exercise 10, which also gives a precise definition of path connectedness. Since the Intermediate Value Theorem from calculus implies that a locally constant function on a path connected set is constant (see Exercise 10), we conclude that  $m_{i,B}$  takes the same value for all  $B \in M_{3 \times 3}(\mathbb{C}) - \mathbf{V}(H)$ . Thus the intersection multiplicities of Definition 8 are well-defined.  $\square$

The intersection multiplicities  $I_p(C, D)$  have many properties which make them easier to compute. For example, one can show that  $I_p(C, D) = 1$  if and only if  $p$  is a nonsingular point of  $C$  and  $D$  and the curves have distinct tangent lines at  $p$ . A discussion of the properties of multiplicities can be found in Chapter 3 of KIRWAN (1992). We should also point out that using resultants to define multiplicities is unsatisfactory in the following sense. Namely, an intersection multiplicity  $I_p(C, D)$  is clearly a *local* object—it depends only on the part of the curves  $C$  and  $D$  near  $p$ —while the resultant is a *global* object, since it uses the equations for all of  $C$  and  $D$ . Local methods for computing multiplicities are available, though they require slightly more sophisticated mathematics. The local point of view is discussed in Chapter 3 of FULTON (1969) and Chapter IV of WALKER(1950).

As an application of what we've done so far in this section, we will prove the following result of Pascal. Suppose we have six distinct points  $p_1, \dots, p_6$  on an irreducible conic in  $\mathbb{P}^2$ . By Bezout's Theorem, a line meets the conic in at most 2 points (see Exercise 11). Hence, we get six distinct lines by connecting  $p_1$  to  $p_2, p_2$  to  $p_3, \dots$ , and  $p_6$  to  $p_1$ . If we label these lines  $L_1, \dots, L_6$ , then we get the following picture:

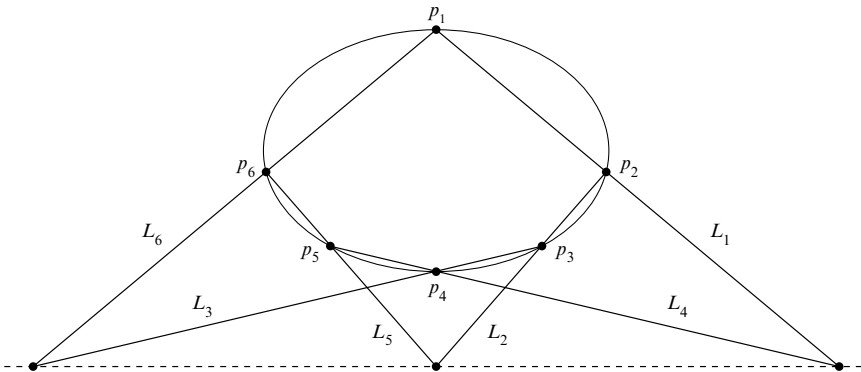

We say that lines  $L_1, L_4$  are *opposite*, and similarly the pairs  $L_2, L_5$  and  $L_3, L_6$  are opposite. The portions of the lines lying inside the conic form a hexagon, and opposite lines correspond to opposite sides of the hexagon.

In the above picture, the intersections of the opposite pairs of lines appear to lie on the same line. The following theorem reveals that this is no accident.

**Theorem 12 (Pascal's Mystic Hexagon).** *Given six points on an irreducible conic, connected by six lines as above, the points of intersection of the three pairs of opposite lines are collinear.*

**Proof.** Let the conic be  $C$ . As above, we have six points  $p_1, \dots, p_6$  and three pairs of opposite lines  $\{L_1, L_4\}$ ,  $\{L_2, L_5\}$ , and  $\{L_3, L_6\}$ . Now consider the curves  $C_1 = L_1 \cup L_3 \cup L_5$  and  $C_2 = L_2 \cup L_4 \cup L_6$ . These curves are defined by cubic equations, so that by Bezout's Theorem, the number of points in  $C_1 \cap C_2$  is 9 (counting multiplicities). However, note that  $C_1 \cap C_2$  contains the six original points  $p_1, \dots, p_6$  and the three points of intersection of opposite pairs of lines (you should check this carefully). Thus, these are all of the points of intersection, and all of the multiplicities are one.

Suppose that  $C = \mathbf{V}(f)$ ,  $C_1 = \mathbf{V}(g_1)$  and  $C_2 = \mathbf{V}(g_2)$ , where  $f$  has total degree 2 and  $g_1$  and  $g_2$  have total degree 3. Now pick a point  $p \in C$  distinct from  $p_1, \dots, p_6$ . Thus,  $g_1(p)$  and  $g_2(p)$  are nonzero (do you see why?), so that  $g = g_2(p)g_1 - g_1(p)g_2$  is a cubic polynomial which vanishes at  $p, p_1, \dots, p_6$ . Furthermore,  $g$  is nonzero since otherwise  $g_1$  would be a multiple of  $g_2$  (or vice versa). Hence, the cubic  $\mathbf{V}(g)$  meets the conic  $C$  in at least seven points, so that the hypotheses for Bezout's Theorem are not satisfied. Thus, either  $g$  is not reduced or  $\mathbf{V}(g)$  and  $C$  have a common irreducible component. The first of these can't occur, since if  $g$  weren't reduced, the curve  $\mathbf{V}(g)$  would be defined by an equation of degree at most 2 and  $\mathbf{V}(g) \cap C$  would have at most 4 points by Bezout's Theorem. Hence,  $\mathbf{V}(g)$  and  $C$  must have a common irreducible component. But  $C$  is irreducible, which implies that  $C = \mathbf{V}(f)$  is a component of  $\mathbf{V}(g)$ . By Proposition 4, it follows that  $f$  must divide  $g$ .

Hence, we get a factorization  $g = f \cdot l$ , where  $l$  has total degree 1. Since  $g$  vanishes where the opposite lines meet and  $f$  doesn't, it follows that  $l$  vanishes at these points. Since  $\mathbf{V}(l)$  is a projective line, the theorem is proved.  $\square$

Bezout's Theorem serves as a nice introduction to the study of curves in  $\mathbb{P}^2$ . This part of algebraic geometry is traditionally called *algebraic curves* and includes many interesting topics we have omitted (inflection points, dual curves, elliptic curves, etc.). Fortunately, there are several excellent texts on this subject. In addition to FULTON (1969), KIRWAN (1992) and WALKER (1950) already mentioned, we also warmly recommend CLEMENS (1980) and BRIESKORN and KNÖRRER (1986). For students with a background in complex analysis and topology, we also suggest GRIFFITHS (1989).

### EXERCISES FOR §7

1. This exercise is concerned with the parabola  $y = x^2$  and the ellipse  $x^2 + 4(y - \lambda)^2 = 4$  from Example 1.
  - a. Show that these curves have empty intersection over  $\mathbb{R}$  when  $\lambda < -1$ . Illustrate the cases  $\lambda < -1$  and  $\lambda = -1$  with a picture.
  - b. Find the smallest positive real number  $\lambda_0$  such that the intersection over  $\mathbb{R}$  is empty when  $\lambda > \lambda_0$ . Illustrate the cases  $\lambda > \lambda_0$  and  $\lambda = \lambda_0$  with a picture.

- c. When  $-1 < \lambda < \lambda_0$ , describe the possible types of intersections that can occur over  $\mathbb{R}$  and illustrate each case with a picture.
  - d. In the pictures for parts (a), (b), and (c) use the intuitive idea of multiplicity from Example 1 to determine which ones represent intersections with multiplicity  $> 1$ .
  - e. Without using Bezout's Theorem, explain why over  $\mathbb{C}$ , the number of intersections (counted with multiplicity) adds up to 4 when  $\lambda$  is real. Hint: Use the formulas for  $x$  and  $y$  given in Example 1.
2. In Example 2, we intersected the parabola  $y = x^2$  with a line  $L$  in affine space. Assume that  $L$  is not vertical.
    - a. Over  $\mathbb{R}$ , show that the number of points of intersection can be 0, 1, or 2. Further, show that you get one point of intersection exactly when  $L$  is tangent to  $y = x^2$  in the sense of Chapter 3, §4.
    - b. Over  $\mathbb{C}$ , show (without using Bezout's Theorem) that the number of intersections (counted with multiplicity) is exactly 2.
  3. In proving Proposition 4, we showed that if  $f = gh$  is homogeneous and  $g = g_m + \cdots + g_0$ , where  $g_i$  is homogeneous of total degree  $i$  and  $g_m \neq 0$ , and similarly  $h = h_n + \cdots + h_0$ , then  $f = g_m h_n$ . Complete the proof by showing that  $g = g_m$  and  $h = h_n$ . Hint: Let  $m_0$  be the smallest index  $m_0$  such that  $g_{m_0} \neq 0$ , and define  $h_{n_0} \neq 0$  similarly.
  4. In this exercise, we sketch an alternate proof of Lemma 5. Given  $f$  and  $g$  as in the statement of the lemma, let  $R(x, y) = \text{Res}(f, g, z)$ . It suffices to prove that  $R(tx, ty) = t^{mn} R(x, y)$ .
    - a. Use  $a_i(tx, ty) = t^i a_i(x, y)$  and  $b_i(tx, ty) = t^i b_i(x, y)$  to show that  $R(tx, ty)$  is given by a determinant whose entries are either 0 or  $t^i a_i(x, y)$  or  $t^i b_i(x, y)$ .
    - b. In the determinant from part (a), multiply column 2 by  $t$ , column 3 by  $t^2, \dots$ , column  $n$  by  $t^{n-1}$ , column  $n+2$  by  $t$ , column  $n+3$  by  $t^2, \dots$ , and column  $n+m$  by  $t^{m-1}$ . Use this to prove that  $t^q R(tx, ty)$ , where  $q = n(n-1)/2 + m(m-1)/2$ , equals a determinant where in each row,  $t$  appears to the *same* power.
    - c. By pulling out the powers of  $t$  from the rows of the determinant from part (b) prove that  $t^q R(tx, ty) = t^r R(x, y)$ , where  $r = (m+n)(m+n-1)/2$ .
    - d. Use part (c) to prove that  $R(tx, ty) = t^{mn} R(x, y)$ , as desired.
  5. Complete the proof of Lemma 6 using the hints given in the text. Hint: Use Proposition 7 and Exercise 11 from §2.
  6. This exercise is concerned with the proof of Theorem 7.
    - a. Let  $f \in \mathbb{C}[x_1, \dots, x_n]$  be a nonzero polynomial. Prove that  $\mathbf{V}(f)$  and  $\mathbb{C}^n - \mathbf{V}(f)$  are nonempty. Hint: Use the Nullstellensatz and Proposition 5 of Chapter 1, §1.
    - b. Use part (a) to prove that you can find  $q \notin C \cup D \cup \bigcup_{i < j} L_{ij}$  as claimed in the proof of Theorem 7.
    - c. Given  $q \in \mathbb{P}^2(\mathbb{C})$ , find  $A \in \text{GL}(3, \mathbb{C})$  such that  $A(q) = (0, 0, 1)$ . Hint: Regard  $q$  and  $(0, 0, 1)$  as nonzero column vectors in  $\mathbb{C}^3$  and use linear algebra to find an invertible matrix  $A$  such that  $A(q) = (0, 0, 1)$ .
    - d. Prove that the projective line connecting  $(0, 0, 1)$  to  $(u, v, w)$  intersects the line  $z = 0$  in the point  $(u, v, 0)$ . Hint: Use equation (10) of §6.
  7. In Example 9, we considered the curves  $C = \mathbf{V}(f)$  and  $D = \mathbf{V}(g)$ , where  $f$  and  $g$  are given in the text.
    - a. Verify carefully that  $p = (0, 0, 1)$ ,  $q = (1, 1, 1)$  and  $r = (4/7, -8/7, 1)$  are the only points of intersection of the curves  $C$  and  $D$ . Hint: Once you have  $\text{Res}(f, g, z)$ , you can do the rest by hand.
    - b. Show that  $f$  and  $g$  are reduced. Hint: Use a computer.
    - c. Show that  $(0, 1, 0) \notin C \cup D \cup L_{pq} \cup L_{pr} \cup L_{qr}$ .

8. For each of the following pairs of curves, find the points of intersection and compute the intersection multiplicities.
- $C = \mathbf{V}(yz - x^2)$  and  $D = \mathbf{V}(x^2 + 4(y - z)^2 - 4z^2)$ . This is the projective version of Example 1 when  $\lambda = 1$ . Hint: Show that the coordinate change given by  $A(x, y, z) = (x, y + z, z)$  has the desired properties.
  - $C = \mathbf{V}(x^2y^3 - 2xy^2z^2 + yz^4 + z^5)$  and  $D = \mathbf{V}(x^2y^2 - xz^3 - z^4)$ . Hint: There are four solutions, two real and two complex. When finding the complex solutions, computing the GCD of two complex polynomials may help.
9. Prove (5). Hint: Use induction on  $m$ , and apply the inductive hypothesis to  $\partial G/\partial x$  and  $\partial G/\partial y$ .
10. (Requires advanced calculus.) An open set  $U \subset \mathbb{C}^n$  is *path connected* if for every two points  $a, b \in U$ , there is a continuous function  $\gamma : [0, 1] \rightarrow U$  such that  $\gamma(0) = a$  and  $\gamma(1) = b$ .
- Suppose that  $F : U \rightarrow \mathbb{Z}$  is locally constant (as in the text, this means that the value of  $F$  at a point of  $U$  equals its value at all nearby points). Use the Intermediate Value Theorem from calculus to show that  $F$  is constant when  $U$  is path connected. Hint: If we regard  $F$  as a function  $F : U \rightarrow \mathbb{R}$ , explain why  $F$  is continuous. Then note that  $F \circ \gamma : [0, 1] \rightarrow \mathbb{R}$  is also continuous.
  - Let  $f \in \mathbb{C}[x]$  be a nonzero polynomial. Prove that  $\mathbb{C} - \mathbf{V}(f)$  is path connected.
  - If  $f \in \mathbb{C}[x_1, \dots, x_n]$  is nonzero, prove that  $\mathbb{C} - \mathbf{V}(f)$  is path connected. Hint: Given  $a, b \in \mathbb{C}^n - \mathbf{V}(f)$ , consider the complex line  $\{ta + (1 - t)b : t \in \mathbb{C}\}$  determined by  $a$  and  $b$ . Explain why  $f(ta + (1 - t)b)$  is a nonzero polynomial in  $t$  and use part (b).
  - Give an example of  $f \in \mathbb{R}[x, y]$  such that  $\mathbb{R}^2 - \mathbf{V}(f)$  is not path connected. Further, find a locally constant function  $F : \mathbb{R}^2 - \mathbf{V}(f) \rightarrow \mathbb{Z}$  which is not constant. Thus, it is essential that we work over  $\mathbb{C}$ .
11. Let  $C$  be an irreducible conic in  $\mathbb{P}^2(\mathbb{C})$ . Use Bezout's Theorem to explain why a line  $L$  meets  $C$  in at most two points. What happens when  $C$  is reducible? What about when  $C$  is a curve defined by an irreducible polynomial of total degree  $n$ ?
12. In the picture drawn in the text for Pascal's Mystic Hexagon, the six points went clockwise around the conic. If we change the order of the points, we can still form a "hexagon," though opposite lines might intersect inside the conic. For example, the picture could be as follows:

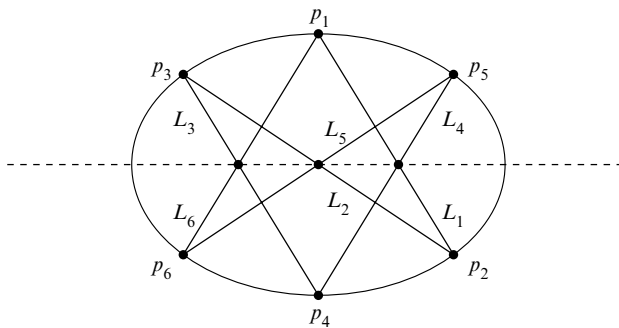

Explain why the theorem remains true in this case.

13. In Pascal's Mystic Hexagon, suppose that the conic is a circle and the six lines come from a regular hexagon inscribed inside the circle. Where do the opposite lines meet and on what line do their intersections lie?

14. Pappus's Theorem from Exercise 8 of Chapter 6, §4, states that if  $p_3, p_1, p_5$  and  $p_6, p_4, p_2$  are two collinear triples of points and we set

$$\begin{aligned} p &= \overline{p_3 p_4} \cap \overline{p_6 p_1} \\ q &= \overline{p_2 p_3} \cap \overline{p_5 p_6} \\ r &= \overline{p_4 p_5} \cap \overline{p_1 p_2}. \end{aligned}$$

then  $p, q, r$  are also collinear. The picture is as follows:

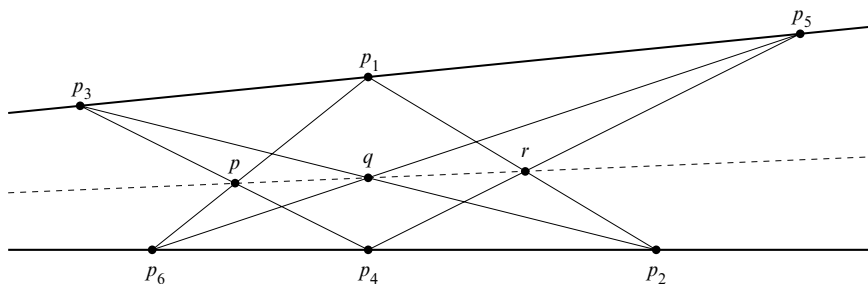

The union of the lines  $\overline{p_3 p_1}$  and  $\overline{p_6 p_4}$  is a reducible conic  $C'$ . Explain why Pappus's Theorem can be regarded as a "degenerate" case of Pascal's Mystic Hexagon. Hint: See Exercise 12. Note that unlike the irreducible case, we can't choose any six points on  $C'$ : we must avoid the singular point of  $C'$ , and each component of  $C'$  must contain three of the points.

15. The argument used to prove Theorem 12 applies in much more general situations. Suppose that we have curves  $C$  and  $D$  defined by reduced equations of total degree  $n$  such that  $C \cap D$  consists of exactly  $n^2$  points. Furthermore, suppose there is an irreducible curve  $E$  with a reduced equation of total degree  $m < n$  which contains exactly  $mn$  of these  $n^2$  points. Then adapt the argument of Theorem 12 to show that there is a curve  $F$  with a reduced equation of total degree  $n - m$  which contains the remaining  $n(n - m)$  points of  $C \cap D$ .
16. Let  $C$  and  $D$  be curves in  $\mathbb{P}^2(\mathbb{C})$ .
- Prove that  $C \cap D$  must be nonempty.
  - Suppose that  $C$  is nonsingular in the sense of part (a) of Exercise 9 of §6 [if  $C = \mathbf{V}(f)$ , this means the partial derivatives  $\partial f/\partial x$ ,  $\partial f/\partial y$  and  $\partial f/\partial z$  don't vanish simultaneously on  $\mathbb{P}^2(\mathbb{C})$ ]. Prove that  $C$  is irreducible. Hint: Suppose that  $C = C_1 \cup C_2$ , which implies  $f = f_1 f_2$ . How do the partials of  $f$  behave at a point of  $C_1 \cap C_2$ ?
17. This exercise will explore an informal proof of Bezout's Theorem. The argument is not rigorous but does give an intuitive explanation of why the number of intersection points is  $mn$ .
- In  $\mathbb{P}^2(\mathbb{C})$ , show that a line  $L$  meets a curve  $C$  of degree  $n$  in  $n$  points, counting multiplicity. Hint: Choose coordinates so that all of the intersections take place in  $\mathbb{C}^2$ , and write  $L$  parametrically as  $x = a + ct$ ,  $y = b + dt$ .
  - If a curve  $C$  of degree  $n$  meets a union of  $m$  lines, use part (a) to predict how many points of intersection there are.
  - When two curves  $C$  and  $D$  meet, give an intuitive argument (based on pictures) that the number of intersections (counting multiplicity) doesn't change if one of the curves moves a bit. Your pictures should include instances of tangency and the example of the intersection of the  $x$ -axis with the cubic  $y = x^3$ .

- d. Use the constancy principle from part (c) to argue that if the  $m$  lines in part (b) all coincide (giving what is called a line of *multiplicity*  $m$ ), the number of intersections (counted with multiplicity) is still as predicted.
- e. Using the constancy principle from part (c) argue that Bezout's Theorem holds for general curves  $C$  and  $D$  by moving  $D$  to a line of multiplicity  $m$  [as in part (d)]. Hint: If  $D$  is defined by  $f = 0$ , you can "move"  $D$  letting all but one coefficient of  $f$  go to zero.

In technical terms, this is a *degeneration* proof of Bezout's Theorem. A rigorous version of this argument can be found in BRIESKORN and KNÖRRER (1986). Degeneration arguments play an important role in algebraic geometry.

# 9

## The Dimension of a Variety

The most important invariant of a linear subspace of affine space is its dimension. For affine varieties, we have seen numerous examples which have a clearly defined dimension, at least from a naive point of view. In this chapter, we will carefully define the dimension of any affine or projective variety and show how to compute it. We will also show that this notion accords well with what we would expect intuitively. In keeping with our general philosophy, we consider the computational side of dimension theory right from the outset.

### §1 The Variety of a Monomial Ideal

We begin our study of dimension by considering monomial ideals. In particular, we want to compute the dimension of the variety defined by such an ideal. Suppose, for example, we have the ideal  $I = \langle x^2y, x^3 \rangle$  in  $k[x, y]$ . Letting  $H_x$  denote the line in  $k^2$  defined by  $x = 0$  (so  $H_x = \mathbf{V}(x)$ ) and  $H_y$  the line  $y = 0$ , we have

$$\begin{aligned} \mathbf{V}(I) &= \mathbf{V}(x^2y) \cap \mathbf{V}(x^3) \\ &= (H_x \cup H_y) \cap H_x \\ &= (H_x \cap H_x) \cup (H_y \cap H_x) \\ &= H_x. \end{aligned} \tag{1}$$

Thus,  $\mathbf{V}(I)$  is the  $y$ -axis  $H_x$ . Since  $H_x$  has dimension 1 as a vector subspace of  $k^2$ , it is reasonable to say that it also has dimension 1 as a variety.

As a second example, consider the ideal

$$I = \langle y^2z^3, x^5z^4, x^2yz^2 \rangle \subset k[x, y, z].$$

Let  $H_x$  be the plane defined by  $x = 0$  and define  $H_y$  and  $H_z$  similarly. Also, let  $H_{xy}$  be the line  $x = y = 0$ . Then we have

$$\begin{aligned} \mathbf{V}(I) &= \mathbf{V}(y^2z^3) \cap \mathbf{V}(x^5z^4) \cap \mathbf{V}(x^2yz^2) \\ &= (H_y \cup H_z) \cap (H_x \cup H_z) \cap (H_x \cup H_y \cup H_z) \\ &= H_z \cup H_{xy}. \end{aligned}$$



To verify this, note that the plane  $H_z$  belongs to each of the three terms in the second line and, hence, to their intersection. Thus,  $\mathbf{V}(I)$  will consist of the plane  $H_z$  together, perhaps, with some other subset not contained in  $H_z$ . Collecting terms not contained in  $H_z$ , we have  $H_y \cap H_x \cap (H_x \cup H_y)$ , which equals  $H_{xy}$ . Thus,  $\mathbf{V}(I)$  is the union of the  $(x, y)$ -plane  $H_z$  and the  $z$ -axis  $H_{xy}$ . We will say that the dimension of a union of finitely many vector subspaces of  $k^n$  is the biggest of the dimensions of the subspaces, and so the dimension of  $\mathbf{V}(I)$  is 2 in this example.

The variety of any monomial ideal may be assigned a dimension in much the same fashion. But first we need to describe what a variety of a general monomial ideal looks like. In  $k^n$ , a vector subspace defined by setting some subset of the variables  $x_1, \dots, x_n$  equal to zero is called a *coordinate subspace*.

**Proposition 1.** *The variety of a monomial ideal in  $k[x_1, \dots, x_n]$  is a finite union of coordinate subspaces of  $k^n$ .*

**Proof.** First, note that if  $x_{i_1}^{\alpha_1} \dots x_{i_r}^{\alpha_r}$  is a monomial in  $k[x_1, \dots, x_n]$  with  $\alpha_j \geq 1$  for  $1 \leq j \leq r$ , then

$$\mathbf{V}(x_{i_1}^{\alpha_1} \dots x_{i_r}^{\alpha_r}) = H_{x_{i_1}} \cup \dots \cup H_{x_{i_r}},$$

where  $H_{x_k} = \mathbf{V}(x_k)$ . Thus, the variety defined by a monomial is a union of coordinate hyperplanes. Note also that there are only  $n$  such hyperplanes.

Since a monomial ideal is generated by a finite collection of monomials, the variety corresponding to a monomial ideal is a finite intersection of unions of coordinate hyperplanes. By the distributive property of intersections over unions, any finite intersection of unions of coordinate hyperplanes can be rewritten as a finite union of intersections of coordinate hyperplanes [see (1) for an example of this]. But the intersection of any collection of coordinate hyperplanes is a coordinate subspace.  $\square$

When we write the variety of a monomial ideal  $I$  as a union of finitely many coordinate subspaces, we can omit a subspace if it is contained in another in the union. Thus, we can write  $\mathbf{V}(I)$  as a union of coordinate subspaces.

$$\mathbf{V}(I) = V_1 \cup \dots \cup V_p,$$

where  $V_i \not\subset V_j$  for  $i \neq j$ . In fact, such a decomposition is unique, as you will show in Exercise 8.

Let us make the following provisional definition. We will always assume that  $k$  is infinite.

**Definition 2.** *Let  $V$  be a variety which is the union of a finite number of linear subspaces of  $k^n$ . Then the dimension of  $V$ , denoted  $\dim V$ , is the largest of the dimensions of the subspaces.*

Thus, the dimension of the union of two planes and a line is 2, and the dimension of a union of three lines is 1. To compute the dimension of the variety corresponding to

a monomial ideal, we merely find the maximum of the dimensions of the coordinate subspaces contained in  $\mathbf{V}(I)$ .

Although this is easy to do for any given example, it is worth systematizing the computation. Let  $I = \langle m_1, \dots, m_t \rangle$  be a proper ideal generated by the monomials  $m_j$ . In trying to compute  $\dim \mathbf{V}(I)$ , we need to pick out the component of

$$\mathbf{V}(I) = \bigcap_{j=1}^t \mathbf{V}(m_j)$$

of largest dimension. If we can find a collection of variables  $x_{i_1}, \dots, x_{i_r}$  such that at least one of these variables appears in each  $m_j$ , then the coordinate subspace defined by the equations  $x_{i_1} = \dots = x_{i_r} = 0$  is contained in  $\mathbf{V}(I)$ . This means we should look for variables which occur in as many of the different  $m_j$  as possible. More precisely, for  $1 \leq j \leq t$ , let

$$M_j = \{k \in \{1, \dots, n\} : x_k \text{ divides the monomial } m_j\}$$

be the set of subscripts of variables occurring with positive exponent in  $m_j$ . (Note that  $M_j$  is nonempty by our assumption that  $I \neq k[x_1, \dots, x_n]$ .) Then let

$$\mathcal{M} = \{J \subset \{1, \dots, n\} : J \cap M_j \neq \emptyset \text{ for all } 1 \leq j \leq t\}$$

consist of all subsets of  $\{1, \dots, n\}$  which have nonempty intersection with *every* set  $M_j$ . (Note that  $\mathcal{M}$  is not empty because  $\{1, \dots, n\} \in \mathcal{M}$ .) If we let  $|J|$  denote the number of elements in a set  $J$ , then we have the following.

**Proposition 3.** *With the notation above,*

$$\dim \mathbf{V}(I) = n - \min(|J| : J \in \mathcal{M}).$$

**Proof.** Let  $J = \{i_1, \dots, i_r\}$  be an element of  $\mathcal{M}$  such that  $|J| = r$  is minimal in  $\mathcal{M}$ . Since each monomial  $m_j$  contains some power of some  $x_{i_k}$ ,  $1 \leq k \leq r$ , the coordinate subspace  $W = \mathbf{V}(x_{i_1}, \dots, x_{i_r})$  is contained in  $\mathbf{V}(I)$ . The dimension of  $W$  is  $n - r = n - |J|$ , and hence, by Definition 2, the dimension of  $\mathbf{V}(I)$  is at least  $n - |J|$ .

If  $\mathbf{V}(I)$  had dimension larger than  $n - r$ , then for some  $s < r$  there would be a coordinate subspace  $W' = \mathbf{V}(x_{k_1}, \dots, x_{k_s})$  contained in  $\mathbf{V}(I)$ . Each monomial  $m_j$  would vanish on  $W'$  and, in particular, it would vanish at the point  $p \in W'$  whose  $k_i$ -th coordinate is 0 for  $1 \leq i \leq s$  and whose other coordinates are 1. Hence, at least one of the  $x_{k_i}$  must divide  $m_j$ , and it would follow that  $J' = \{k_1, \dots, k_s\} \in \mathcal{M}$ . Since  $|J'| = s < r$ , this would contradict the minimality of  $r$ . Thus, the dimension of  $\mathbf{V}(I)$  must be as claimed.  $\square$

Let us check this on the second example given above. To match the notation of the proposition, we relabel the variables  $x, y, z$  as  $x_1, x_2, x_3$ , respectively. Then

$$I = \langle x_2^2 x_3^3, x_1^5 x_3^4, x_1^2 x_2 x_3^2 \rangle = \langle m_1, m_2, m_3 \rangle,$$

where

$$m_1 = x_2^2 x_3^3, \quad m_2 = x_1^5 x_3^4, \quad m_3 = x_1^2 x_2 x_3^2.$$

Using the notation of the discussion preceding Proposition 3,

$$M_1 = \{2, 3\}, \quad M_2 = \{1, 3\}, \quad M_3 = \{1, 2, 3\},$$

so that

$$\mathcal{M} = \{\{1, 2, 3\}, \{1, 2\}, \{1, 3\}, \{2, 3\}, \{3\}\}.$$

Then  $\min(|J| : J \in \mathcal{M}) = 1$ , which implies that

$$\dim \mathbf{V}(I) = 3 - \min_{J \in \mathcal{M}} |J| = 3 - 1 = 2.$$

Generalizing this example, note that if some variable, say  $x_i$ , appears in every monomial in a set of generators for a proper monomial ideal  $I$ , then it will be true that  $\dim \mathbf{V}(I) = n - 1$  since  $J = \{i\} \in \mathcal{M}$ . For a converse, see Exercise 4.

It is also interesting to compare a monomial ideal  $I$  to its radical  $\sqrt{I}$ . In the exercises, you will show that  $\sqrt{I}$  is a monomial ideal when  $I$  is. We also know from Chapter 4 that  $\mathbf{V}(I) = \mathbf{V}(\sqrt{I})$  for any ideal  $I$ . It follows from Definition 2 that  $\mathbf{V}(I)$  and  $\mathbf{V}(\sqrt{I})$  have the same dimension (since we defined dimension in terms of the underlying variety). In Exercise 10 you will check that this is consistent with the formula given in Proposition 3.

### EXERCISES FOR §1

- For each of the following monomial ideals  $I$ , write  $\mathbf{V}(I)$  as a union of coordinate subspaces.
  - $I = (x^5, x^4 y z, x^3 z) \subset k[x, y, z]$ .
  - $I = (w x^2 y, x y z^3, w z^5) \subset k[w, x, y, z]$ .
  - $I = (x_1 x_2, x_3 \cdots x_n) \subset k[x_1, \dots, x_n]$ .
- Find  $\dim \mathbf{V}(I)$  for each of the following monomial ideals.
  - $I = (x y, y z, x z) \subset k[x, y, z]$ .
  - $I = (w x^2 z, w^3 y, w x y z, x^5 z^6) \subset k[w, x, y, z]$ .
  - $I = (u^2 v w y z, w x^3 y^3, u x y^7 z, y^3 z, u w x^3 y^3 z^2) \subset k[u, v, w, x, y, z]$ .
- Show that  $W \subset k^n$  is a coordinate subspace if and only if  $W$  can be spanned by a subset of the basis vectors  $\{\mathbf{e}_i : 1 \leq i \leq n\}$ , where  $\mathbf{e}_i$  is the vector consisting of all zeros except for a 1 in the  $i$ -th place.
- Suppose that  $I \subset k[x_1, \dots, x_n]$  is a monomial ideal such that  $\dim \mathbf{V}(I) = n - 1$ .
  - Show that the monomials in any generating set for  $I$  have a nonconstant common factor.
  - Write  $\mathbf{V}(I) = V_1 \cup \cdots \cup V_p$ , where  $V_i$  is a coordinate subspace and  $V_i \not\subset V_j$  for  $i \neq j$ . Suppose, in addition, that exactly one of the  $V_i$  has dimension  $n - 1$ . What is the maximum that  $p$  (the number of components) can be? Give an example in which this maximum is achieved.
- Let  $I$  be a monomial ideal in  $k[x_1, \dots, x_n]$  such that  $\dim \mathbf{V}(I) = 0$ .
  - What is  $\mathbf{V}(I)$  in this case?
  - Show that  $\dim \mathbf{V}(I) = 0$  if and only if for each  $1 \leq i \leq n$ ,  $x_i^{\ell_i} \in I$  for some  $\ell_i \geq 1$ .  
Hint: In Proposition 3, when will it be true that  $\mathcal{M}$  contains only  $J = \{1, \dots, n\}$ ?

6. Let  $\langle m_1, \dots, m_r \rangle \subset k[x_1, \dots, x_n]$  be a monomial ideal generated by  $r \leq n$  monomials. Show that  $\dim \mathbf{V}(m_1, \dots, m_r) \geq n - r$ .
7. Show that a coordinate subspace is an irreducible variety when the field  $k$  is infinite.
8. In this exercise, we will relate the decomposition of the variety of a monomial ideal  $I$  as a union of coordinate subspaces given in Proposition 1 with the decomposition of  $\mathbf{V}(I)$  into irreducible components. We will assume that the field  $k$  is infinite.
  - a. If  $\mathbf{V}(I) = V_1 \cup \dots \cup V_k$ , where the  $V_j$  are coordinate subspaces such that  $V_i \not\subset V_j$  if  $i \neq j$ , then show that this union is the minimal decomposition of  $\mathbf{V}(I)$  into irreducible varieties given in Theorem 4 of Chapter 4, §6.
  - b. Deduce that the  $V_j$  in part (a) are unique up to the order in which they are written.
9. Let  $I = \langle m_1, \dots, m_s \rangle$  be a monomial ideal in  $k[x_1, \dots, x_n]$ . For each  $1 \leq j \leq s$ , let  $M_j = \{k : x_k \text{ divides } m_j\}$  as in the text, and consider the monomial

$$m'_j = \prod_{k \in M_j} x_k.$$

Note that  $m'_j$  contains exactly the same variables as  $m_j$ , but all to the first power.

- a. Show that  $m'_j \in \sqrt{I}$  for each  $1 \leq j \leq s$ .
  - b. Show that  $\sqrt{I} = \langle m'_1, \dots, m'_s \rangle$ . Hint: Use Lemmas 2 and 3 of Chapter 2, §4.
10. Let  $I$  be a monomial ideal. Using Exercise 9, show the equality  $\dim \mathbf{V}(I) = \dim \mathbf{V}(\sqrt{I})$  follows from the dimension formula given in Proposition 3.

## §2 The Complement of a Monomial Ideal

One of Hilbert's key insights in his famous paper *Über die Theorie der algebraischen Formen* [see HILBERT (1890)] was that the dimension of the variety associated to a monomial ideal could be characterized by the growth of the number of monomials not in the ideal as the total degree increases. We have alluded to this phenomenon in several places in Chapter 5 (notably in Exercise 12 of §3).

In this section, we will make a careful study of the monomials not contained in a monomial ideal  $I \subset k[x_1, \dots, x_n]$ . Since there may be infinitely many such monomials, our goal will be to find a formula for the number of monomials  $x^\alpha \notin I$  which have total degree less than some bound. The results proved here will play a crucial role in §3 when we define the dimension of an arbitrary variety.

**Example 1.** Consider a proper monomial ideal  $I$  in  $k[x, y]$ . Since  $I$  is proper (that is,  $I \neq k[x, y]$ ),  $\mathbf{V}(I)$  is either

- a. The origin  $\{(0, 0)\}$ ,
- b. the  $x$ -axis,
- c. the  $y$ -axis, or
- d. the union of the  $x$ -axis and the  $y$ -axis.

In case (a), by Exercise 5 of §1, we must have  $x^a \in I$  and  $y^b \in I$  for some integers  $a, b > 0$ . Here, the number of monomials not in  $I$  will be finite, equal to some constant

$C_0 \leq a \cdot b$ . If we assume that  $a$  and  $b$  are as small as possible, we get the following picture when we look at exponents:

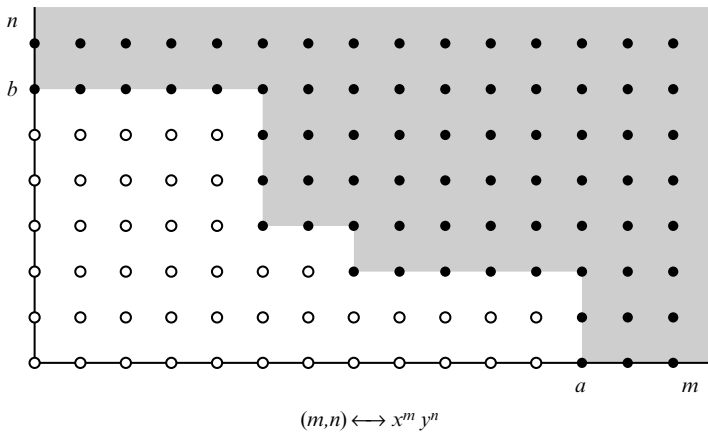

The monomials in  $I$  are indicated by solid dots, while those not in  $I$  are open circles. In case (b), since  $V(I)$  is the  $x$ -axis, no power  $x^k$  of  $x$  can belong to  $I$ . On the other hand, since the  $y$ -axis does not belong to  $V(I)$ , we must have  $y^b \in I$  for some minimal integer  $b > 0$ . The picture would be as follows:

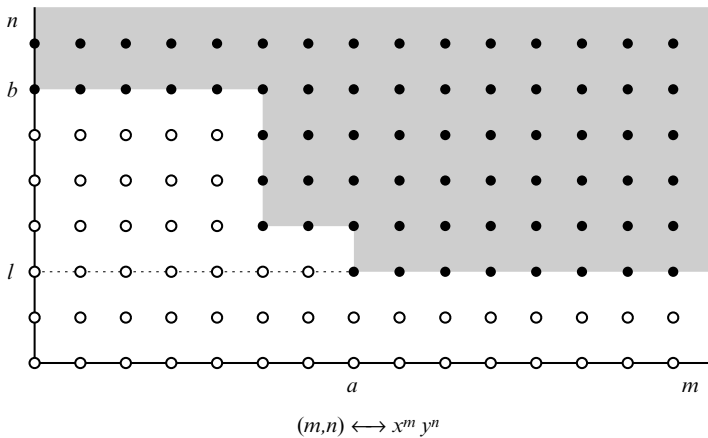

As the picture indicates, we let  $l$  denote the minimum exponent of  $y$  that occurs among *all* monomials in  $I$ . Note that  $l \leq b$ , and we also have  $l > 0$  since no positive power of  $x$  lies in  $I$ . Then the monomials in the complement of  $I$  are precisely the monomials

$$\{x^i y^j : i \in \mathbb{Z}_{\geq 0}, 0 \leq j \leq l - 1\},$$

corresponding to the exponents on  $l$  copies of the horizontal axis in  $\mathbb{Z}_{\geq 0}^2$ , together with a finite number of other monomials. These additional monomials can be characterized as those monomials  $m \notin I$  with the property that  $x^r m \in I$  for some  $r > 0$ . In the above picture, they correspond to the open circles on or above the dotted line.

Thus, the monomials in the complement of  $I$  consist of  $l$  “lines” of monomials together with a finite set of monomials. This description allows us to “count” the number of monomials not in  $I$ . More precisely, in Exercise 1, you will show that if  $s > l$ , the  $l$  “lines” contain precisely  $l(s + 1) - (1 + 2 + \dots + l - 1)$  monomials of total degree  $\leq s$ . In particular, if  $s$  is large enough (more precisely, we must have  $s > a + b$ , where  $a$  is indicated in the above picture), the number of monomials not in  $I$  of total degree  $\leq s$  equals  $ls + C_0$ , where  $C_0$  is some constant depending only on  $I$ .

In case (c), the situation is similar to (b), except that the “lines” of monomials are parallel to the vertical axis in the plane  $\mathbb{Z}_{\geq 0}^2$  of exponents. In particular, we get a similar formula for the number of monomials not in  $I$  of total degree  $\leq s$  once  $s$  is sufficiently large.

In case (d), let  $k$  be the minimum exponent of  $x$  that occurs among all monomials of  $I$ , and similarly let  $l$  be the minimum exponent of  $y$ . Note that  $k$  and  $l$  are positive since  $xy$  must divide every monomial in  $I$ . Then we have the following picture when we look at exponents:

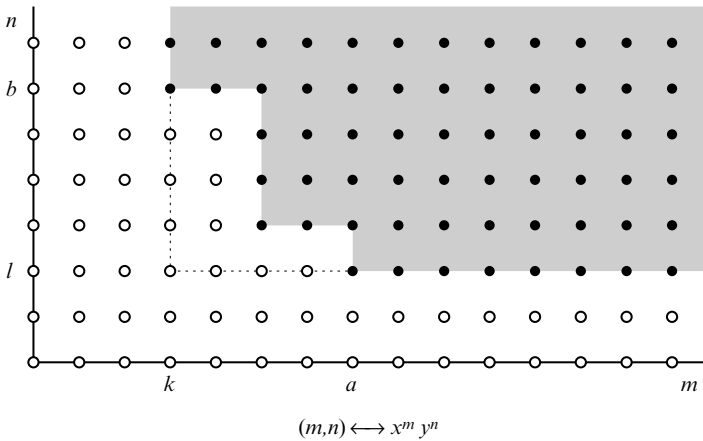

The monomials in the complement of  $I$  consist of the  $k$  “lines” of monomials

$$\{x^i y^j : 0 \leq i \leq k - 1, j \in \mathbb{Z}_{\geq 0}\}$$

parallel to the vertical axis, the  $l$  “lines” of monomials

$$\{x^i y^j : i \in \mathbb{Z}_{\geq 0}, 0 \leq j \leq l - 1\}$$

parallel to the horizontal axis, together with a finite number of other monomials (indicated by open circles inside or on the boundary of the region indicated by the dotted lines).

Thus, the monomials not in  $I$  consist of  $l + k$  “lines” of monomials together with a finite set of monomials. For  $s$  large enough (in fact, for  $s > a + b$ , where  $a$  and  $b$  are as in the above picture) the number of monomials not in  $I$  of total degree  $\leq s$  will be  $(l + k)s + C_0$ , where  $C_0$  is a constant. See Exercise 1 for the details of this claim.

The pattern that appears in Example 1, namely, that the monomials in the complement of a monomial ideal  $I \subset k[x, y]$  consist of a number of infinite families parallel to the “coordinate subspaces” in  $\mathbb{Z}_{\geq 0}^2$ , together with a finite collection of monomials, generalizes to arbitrary monomial ideals. In §3, this will be the key to understanding how to define and compute the dimension of an arbitrary variety.

To discuss the general situation, we will introduce some new notation. For each monomial ideal  $I$ , we let

$$C(I) = \{\alpha \in \mathbb{Z}_{\geq 0}^n : x^\alpha \notin I\}$$

be the set of exponents of monomials *not* in  $I$ . This will be our principal object of study. We also set

$$\begin{aligned} e_1 &= (1, 0, \dots, 0), \\ e_2 &= (0, 1, \dots, 0), \\ &\vdots \\ e_n &= (0, 0, \dots, 1). \end{aligned}$$

Further, we define the *coordinate subspace* of  $\mathbb{Z}_{\geq 0}^n$  determined by  $e_{i_1}, \dots, e_{i_r}$ , where  $i_1 < \dots < i_r$ , to be the set

$$[e_{i_1}, \dots, e_{i_r}] = \{a_1 e_{i_1} + \dots + a_r e_{i_r} : a_j \in \mathbb{Z}_{\geq 0} \text{ for } 1 \leq j \leq r\}.$$

We say that  $[e_{i_1}, \dots, e_{i_r}]$  is an  $r$ -dimensional coordinate subspace. Finally, a subset of  $\mathbb{Z}_{\geq 0}^n$  is a *translate* of a coordinate subspace  $[e_{i_1}, \dots, e_{i_r}]$  if it is of the form

$$\alpha + [e_{i_1}, \dots, e_{i_r}] = \{\alpha + \beta : \beta \in [e_{i_1}, \dots, e_{i_r}]\},$$

where  $\alpha = \sum_{i \notin \{i_1, \dots, i_r\}} a_i e_i$  for  $a_i \geq 0$ . This restriction on  $\alpha$  means that we are translating by a vector perpendicular to  $[e_{i_1}, \dots, e_{i_r}]$ . For example, the set  $\{(1, l) : l \in \mathbb{Z}_{\geq 0}\} = e_1 + [e_2]$  is a translate of the subspace  $[e_2]$  in the plane  $\mathbb{Z}_{\geq 0}^2$  of exponents.

With these definitions in hand, our discussion of monomial ideals in  $k[x, y]$  from Example 1 can be summarized as follows.

- If  $\mathbf{V}(I)$  is the origin, then  $C(I)$  consists of a finite number of points.
- If  $\mathbf{V}(I)$  is the  $x$ -axis, then  $C(I)$  consists of a finite number of translates of  $[e_1]$  and, possibly, a finite number of points not on these translates.
- If  $\mathbf{V}(I)$  is the  $y$ -axis, then  $C(I)$  consists of a finite number of translates of  $[e_2]$  and, possibly, a finite number of points not on these translates.
- If  $\mathbf{V}(I)$  is the union of the  $x$ -axis and the  $y$ -axis, then  $C(I)$  consists of a finite number of translates of  $[e_1]$ , a finite number of translates of  $[e_2]$ , and, possibly, a finite number of points not on either set of translates.

In the exercises, you will carry out a similar analysis for monomial ideals in the polynomial ring in three variables.

Now let us turn to the general case. We first observe that there is a direct correspondence between the coordinate subspaces in  $\mathbf{V}(I)$  and the coordinate subspaces of  $\mathbb{Z}_{\geq 0}^n$  contained in  $C(I)$ .

**Proposition 2.** *Let  $I \subset k[x_1, \dots, x_n]$  be a proper monomial ideal.*

- (i) *The coordinate subspace  $\mathbf{V}(x_i : i \notin \{i_1, \dots, i_r\})$  is contained in  $\mathbf{V}(I)$  if and only if  $[e_{i_1}, \dots, e_{i_r}] \subset C(I)$ .*
- (ii) *The dimension of  $\mathbf{V}(I)$  is the dimension of the largest coordinate subspace in  $C(I)$ .*

**Proof.** (i) $\Rightarrow$ : First note that  $W = \mathbf{V}(x_i : i \notin \{i_1, \dots, i_r\})$  contains the point  $p$  whose  $i_j$ -th coordinate is 1 for  $1 \leq j \leq r$  and whose other coordinates are 0. For any  $\alpha \in [e_{i_1}, \dots, e_{i_r}]$ , the monomial  $x^\alpha$  can be written in the form  $x^\alpha = x_{i_1}^{\alpha_{i_1}} \cdots x_{i_r}^{\alpha_{i_r}}$ . Then  $x^\alpha = 1$  at  $p$ , so that  $x^\alpha \notin I$  since  $p \in W \subset \mathbf{V}(I)$  by hypothesis. This shows that  $\alpha \in C(I)$ .

$\Leftarrow$ : Suppose that  $[e_{i_1}, \dots, e_{i_r}] \subset C(I)$ . Then, since  $I$  is proper, every monomial in  $I$  contains at least one variable other than  $x_{i_1}, \dots, x_{i_r}$ . This means that every monomial in  $I$  vanishes on any point  $(a_1, \dots, a_n) \in k^n$  for which  $a_i = 0$  when  $i \notin \{i_1, \dots, i_r\}$ . So every monomial in  $I$  vanishes on the coordinate subspace  $\mathbf{V}(x_i : i \notin \{i_1, \dots, i_r\})$ , and, hence, the latter is contained in  $\mathbf{V}(I)$ .

(ii) Note that the coordinate subspace  $\mathbf{V}(x_i : i \notin \{i_1, \dots, i_r\})$  has dimension  $r$ . It follows from part (i) that the dimensions of the coordinate subspaces of  $k^n$  contained in  $\mathbf{V}(I)$  and the coordinate subspaces of  $\mathbb{Z}_{\geq 0}^n$  contained in  $C(I)$  are the same. By Definition 2 of §1,  $\dim \mathbf{V}(I)$  is the maximum of the dimensions of the coordinate subspaces of  $k^n$  contained in  $\mathbf{V}(I)$ , so the statement follows.  $\square$

We can now characterize the complement of a monomial ideal.

**Theorem 3.** *If  $I \subset k[x_1, \dots, x_n]$  is a proper monomial ideal, then the set  $C(I) \subset \mathbb{Z}_{\geq 0}^n$  of exponents of monomials not lying in  $I$  can be written as a finite (but not necessarily disjoint) union of translates of coordinate subspaces of  $\mathbb{Z}_{\geq 0}^n$ .*

Before proving the theorem, consider, for example, the ideal  $I = \langle x^4 y^3, x^2 y^5 \rangle$ .

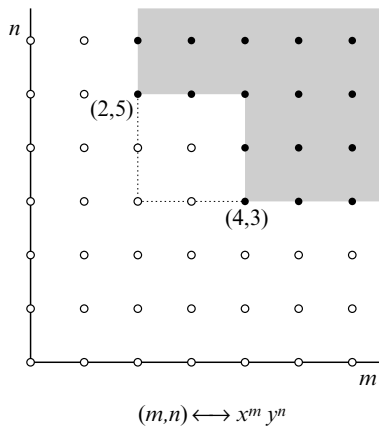



Here, it is easy to see that  $C(I)$  is the finite union

$$C(I) = [e_1] \cup (e_2 + [e_1]) \cup (2e_2 + [e_1]) \cup [e_2] \cup (e_1 + [e_2]) \cup \{(3, 4)\} \cup \{(3, 3)\} \cup \{(2, 4)\} \cup \{(2, 3)\}.$$

We regard the last four sets in this union as being translates of the 0-dimensional coordinate subspace, which is the origin in  $\mathbb{Z}_{\geq 0}^2$ .

**Proof of Theorem 3.** If  $I$  is the zero ideal, the theorem is trivially true, so we can assume that  $I \neq 0$ . The proof is by induction on the number of variables  $n$ . If  $n = 1$ , then  $I = \langle x^k \rangle$  for some integer  $k > 0$ . The only monomials not in  $I$  are  $1, x, \dots, x^{k-1}$ , and hence  $C(I) = \{0, 1, \dots, k-1\} \subset \mathbb{Z}_{\geq 0}$ . Thus, the complement consists of  $k$  points, all of which are translates of the origin.

So assume that the result holds for  $n - 1$  variables and that we have a monomial ideal  $I \subset k[x_1, \dots, x_n]$ . For each integer  $j \geq 0$ , let  $I_j$  be the ideal in  $k[x_1, \dots, x_{n-1}]$  generated by monomials  $m$  with the property that  $m \cdot x_n^j \in I$ . Then  $C(I_j)$  consists of exponents  $\alpha \in \mathbb{Z}_{\geq 0}^{n-1}$  such that  $x^\alpha x_n^j \notin I$ . Geometrically, this says that  $C(I_j) \subset \mathbb{Z}_{\geq 0}^{n-1}$  corresponds to the intersection of  $C(I)$  and the hyperplane  $(0, \dots, 0, j) + [e_1, \dots, e_{n-1}]$  in  $\mathbb{Z}_{\geq 0}^n$ .

Because  $I$  is an ideal, we have  $I_j \subset I_{j'}$  when  $j < j'$ . By the ascending chain condition for ideals, there is an integer  $j_0$  such that  $I_j = I_{j_0}$  for all  $j \geq j_0$ . For any integer  $j$ , we let  $C(I_j) \times \{j\}$  denote the set  $\{(\alpha, j) \in \mathbb{Z}_{\geq 0}^n : \alpha \in C(I_j) \subset \mathbb{Z}_{\geq 0}^{n-1}\}$ . Then we claim the monomials  $C(I)$  not lying in  $I$  can be written as

$$(1) \quad C(I) = (C(I_{j_0}) \times \mathbb{Z}_{\geq 0}) \cup \bigcup_{j=0}^{j_0-1} (C(I_j) \times \{j\}).$$

To prove this claim, first note that  $C(I_j) \times \{j\} \subset C(I)$  by the definition of  $C(I_j)$ . To show that  $C(I_{j_0}) \times \mathbb{Z}_{\geq 0} \subset C(I)$ , observe that  $I_j = I_{j_0}$  when  $j \geq j_0$ , so that  $C(I_{j_0}) \times \{j\} \subset C(I)$  for these  $j$ 's. When  $j < j_0$ , we have  $x^\alpha x_n^j \notin I$  whenever  $x^\alpha x_n^{j_0} \notin I$  since  $I$  is an ideal, which shows that  $C(I_{j_0}) \times \{j\} \subset C(I)$  for  $j < j_0$ . We conclude that  $C(I)$  contains the right-hand side of (1).

To prove the opposite inclusion, take  $\alpha = (\alpha_1, \dots, \alpha_n) \in C(I)$ . Then we have  $\alpha \in C(I_{\alpha_n}) \times \{\alpha_n\}$  by definition. If  $\alpha_n < j_0$ , then  $\alpha$  obviously lies in the right-hand side of (1). On the other hand, if  $\alpha_n \geq j_0$ , then  $I_{\alpha_n} = I_{j_0}$  shows that  $\alpha \in C(I_{j_0}) \times \mathbb{Z}_{\geq 0}$ , and our claim is proved.

If we apply our inductive assumption, we can write  $C(I_0), \dots, C(I_{j_0})$  as finite unions of translates of coordinate subspaces of  $\mathbb{Z}_{\geq 0}^{n-1}$ . Substituting these finite unions into the right-hand side of (1), we immediately see that  $C(I)$  is also a finite union of translates of coordinate subspaces of  $\mathbb{Z}_{\geq 0}^n$ . □

Our next goal is to find a formula for the number of monomials of total degree  $\leq s$  in the complement of a monomial ideal  $I \subset k[x_1, \dots, x_n]$ . Here is one of the key facts we will need.

**Lemma 4.** *The number of monomials of total degree  $\leq s$  in  $k[x_1, \dots, x_m]$  is the binomial coefficient  $\binom{m+s}{s}$ .*

**Proof.** See Exercise 11 of Chapter 5, §3. □

In what follows, we will refer to  $|\alpha| = \alpha_1 + \dots + \alpha_n$  as the *total degree* of  $\alpha \in \mathbb{Z}_{\geq 0}^n$ . This is also the total degree of the monomial  $x^\alpha$ . Using this terminology, Lemma 4 easily implies that the number of points of total degree  $\leq s$  in an  $m$ -dimensional coordinate subspace of  $\mathbb{Z}_{\geq 0}^n$  is  $\binom{m+s}{s}$  (see Exercise 5). Observe that when  $m$  is fixed, the expression

$$\binom{m+s}{s} = \binom{m+s}{m} = \frac{1}{m!}(s+m)(s+m-1)\cdots(s+1)$$

is a polynomial of degree  $m$  in  $s$ . Note that the coefficient of  $s^m$  is  $1/m!$ .

What about the number of monomials of total degree  $\leq s$  in a *translate* of an  $m$ -dimensional coordinate subspace in  $\mathbb{Z}_{\geq 0}^n$ ? Consider, for instance, the translate  $a_{m+1}e_{m+1} + \dots + a_n e_n + [e_1, \dots, e_m]$  of the coordinate subspace  $[e_1, \dots, e_m]$ . Then, since  $a_{m+1}, \dots, a_n$  are fixed, the number of points in the translate with total degree  $\leq s$  is just equal to the number of points in  $[e_1, \dots, e_m]$  of total degree  $\leq s - (a_{m+1} + \dots + a_n)$  provided, of course, that  $s > a_{m+1} + \dots + a_n$ . More generally, we have the following.

**Lemma 5.** *Let  $\alpha + [e_{i_1}, \dots, e_{i_m}]$  be a translate of the coordinate subspace  $[e_{i_1}, \dots, e_{i_m}] \subset \mathbb{Z}_{\geq 0}^n$ , where as usual  $\alpha = \sum_{i \notin \{i_1, \dots, i_m\}} \alpha_i e_i$ .*

(i) *The number of points in  $\alpha + [e_{i_1}, \dots, e_{i_m}]$  of total degree  $\leq s$  is equal to*

$$\binom{m+s-|\alpha|}{s-|\alpha|},$$

*provided that  $s > |\alpha|$ .*

(ii) *For  $s > |\alpha|$ , this number of points is a polynomial function of  $s$  of degree  $m$ , and the coefficient of  $s^m$  is  $1/m!$ .*

**Proof.** (i) If  $s > |\alpha|$ , then each point  $\beta$  in  $\alpha + [e_{i_1}, \dots, e_{i_m}]$  of total degree  $\leq s$  has the form  $\beta = \alpha + \gamma$ , where  $\gamma \in [e_{i_1}, \dots, e_{i_m}]$  and  $|\gamma| \leq s - |\alpha|$ . The formula given in (i) follows using Lemma 4 to count the number of possible  $\gamma$ .

(ii) See Exercise 6. □

We are now ready to prove a connection between the dimension of  $\mathbf{V}(I)$  for a monomial ideal and the degree of the polynomial function which counts the number of points of total degree  $\leq s$  in  $C(I)$ .

**Theorem 6.** *If  $I \subset k[x_1, \dots, x_n]$  is a monomial ideal with  $\dim \mathbf{V}(I) = d$ , then for all  $s$  sufficiently large, the number of monomials not in  $I$  of total degree  $\leq s$  is a polynomial of degree  $d$  in  $s$ . Further, the coefficient of  $s^d$  in this polynomial is positive.*

**Proof.** We need to determine the number of points in  $C(I)$  of total degree  $\leq s$ . By Theorem 3, we know that  $C(I)$  can be written as a finite union

$$C(I) = T_1 \cup T_2 \cup \cdots \cup T_t,$$

where each  $T_i$  is a translate of a coordinate subspace in  $\mathbb{Z}_{\geq 0}^n$ . We can assume that  $T_i \neq T_j$  for  $i \neq j$ .

The *dimension* of  $T_i$  is the dimension of the associated coordinate subspace. Since  $I$  is an ideal, it follows easily that a coordinate subspace  $[e_{i_1}, \dots, e_{i_r}]$  lies in  $C(I)$  if and only if some translate does. By hypothesis,  $\mathbf{V}(I)$  has dimension  $d$ , so that by Proposition 2, each  $T_i$  has dimension  $\leq d$ , with equality occurring for at least one  $T_i$ .

We will sketch the remaining steps in the proof, leaving the verification of several details to the reader as exercises. To count the number of points of total degree  $\leq s$  in  $C(I)$ , we must be careful, since  $C(I)$  is a union of coordinate subspaces of  $\mathbb{Z}_{\geq 0}^n$  that may not be disjoint [for instance, see part (d) of Example 1]. If we use the superscript  $s$  to denote the subset consisting of elements of total degree  $\leq s$ , then it follows that

$$C(I)^s = T_1^s \cup T_2^s \cup \cdots \cup T_t^s.$$

The number of elements in  $C(I)^s$  will be denoted  $|C(I)^s|$ .

In Exercise 7, you will develop a general counting principle (called the Inclusion-Exclusion Principle) that allows us to count the elements in a finite union of finite sets. If the sets in the union have common elements, we cannot simply add to find the total number of elements because that would count some elements in the union more than once. The Inclusion-Exclusion Principle gives “correction terms” that eliminate this multiple counting. Those correction terms are the numbers of elements in double intersections, triple intersections, etc., of the sets in question.

If we apply the Inclusion-Exclusion Principle to the above union for  $C(I)^s$ , we easily obtain

$$(2) \quad |C(I)^s| = \sum_i |T_i^s| - \sum_{i < j} |T_i^s \cap T_j^s| + \sum_{i < j < k} |T_i^s \cap T_j^s \cap T_k^s| - \cdots.$$

By Lemma 5, we know that for  $s$  sufficiently large, the number of points in  $T_i^s$  is a polynomial of degree  $m_i = \dim(T_i) \leq d$  in  $s$ , and the coefficient of  $s^{m_i}$  is  $1/m_i!$ . From this it follows that  $|C(I)^s|$  is a polynomial of degree at most  $d$  in  $s$  when  $s$  is sufficiently large.

We also see that the first sum in (2) is a polynomial of degree  $d$  in  $s$  when  $s$  is sufficiently large. The degree is exactly  $d$  because some of the  $T_i$  have dimension  $d$  and the coefficients of the leading terms are positive and hence can't cancel. If we can show that the remaining sums in (2) correspond to polynomials of smaller degree, it will follow that  $|C(I)^s|$  is given by a polynomial of degree  $d$  in  $s$ . This will also show that the coefficient of  $s^d$  is positive.

You will prove in Exercise 8 that the intersection of two distinct translates of coordinate subspaces of dimensions  $m$  and  $r$  in  $\mathbb{Z}_{\geq 0}^n$  is either empty or a translate of a coordinate subspace of dimension  $< \max(m, r)$ . Let us see how this applies to a nonzero term  $|T_i^s \cap T_j^s|$  in the second sum of (2). Since  $T_i \neq T_j$ , Exercise 8 implies

that  $T = T_i \cap T_j$  is the translate of a coordinate subspace of  $\mathbb{Z}_{\geq 0}^n$  of dimension  $< d$ , so that by Lemma 5, the number of points in  $T^s = T_i^s \cap T_j^s$  is a polynomial in  $s$  of degree  $< d$ . Adding these up for all  $i < j$ , we see that the second sum in (2) is a polynomial of degree  $< d$  in  $s$  for  $s$  sufficiently large. The other sums in (2) are handled similarly, and it follows that  $|C(I)^s|$  is a polynomial of the desired form when  $s$  is sufficiently large.  $\square$

Let us see how this theorem works in the example  $I = \langle x^4y^3, x^2y^5 \rangle$  discussed following Theorem 3. Here, we have already seen that  $C(I) = C_0 \cup C_1$ , where

$$C_1 = [e_1] \cup (e_2 + [e_1]) \cup (2e_2 + [e_1]) \cup [e_2] \cup (e_1 + [e_2]),$$

$$C_0 = \{(3, 4), (3, 3), (2, 4), (2, 3)\}.$$

To count the number of points of total degree  $\leq s$  in  $C_1$ , we count the number in each translate and subtract the number which are counted more than once. (In this case, there are no triple intersections to worry about. Do you see why?) The number of points of total degree  $\leq s$  in  $[e_2]$  is  $\binom{1+s}{s} = \binom{1+s}{1} = s + 1$  and the number in  $e_1 + [e_2]$  is  $\binom{1+s-1}{s-1} = s$ . Similarly, the numbers in  $[e_1]$ ,  $e_2 + [e_1]$ , and  $2e_2 + [e_1]$  are  $s + 1$ ,  $s$ , and  $s - 1$ , respectively. Of the possible intersections of pairs of these, only six are nonempty and each consists of a single point. You can check that  $(1, 2)$ ,  $(1, 1)$ ,  $(1, 0)$ ,  $(0, 2)$ ,  $(0, 1)$ ,  $(0, 0)$  are the six points belonging to more than one translate. Thus, for large  $s$ , the number of points of total degree  $\leq s$  in  $C_1$  is

$$|C_1^s| = (s + 1) + s + (s + 1) + s + (s - 1) - 6 = 5s - 5.$$

Since there are four points in  $C_0$ , the number of points of total degree  $\leq s$  in  $C(I)$  is

$$|C_1^s| + |C_0^s| = (5s - 5) + 4 = 5s - 1,$$

provided that  $s$  is sufficiently large. (In Exercise 9 you will show that in this case,  $s$  is “sufficiently large” as soon as  $s \geq 7$ .)

Theorem 6 shows that the dimension of the affine variety defined by a monomial ideal is equal to the degree of the polynomial in  $s$  which counts the number of points in  $C(I)$  of total degree  $\leq s$  for  $s$  large. This gives a purely algebraic definition of dimension. In §3, we will extend these ideas to general ideals.

The polynomials that occur in Theorem 6 have the property that they take integer values when the variable  $s$  is a sufficiently large integer. For later purposes, it will be useful to characterize this class of polynomials. The first thing to note is that polynomials with this property need *not* have integer coefficients. For example, the polynomial  $\frac{1}{2}s(s - 1)$  takes integer values whenever  $s$  is an integer, but does not have integer coefficients. The reason is that either  $s$  or  $s - 1$  must be even, hence, divisible by 2. Similarly, the polynomial  $\frac{1}{3}2s(s - 1)(s - 2)$  takes integer values for any integer  $s$ : no matter what  $s$  is, one of the three consecutive integers  $s - 2$ ,  $s - 1$ ,  $s$  must be divisible by 3 and at least one of them divisible by 2. It is easy to generalize this argument and

show that

$$\begin{aligned} \binom{s}{d} &= \frac{s(s-1)\cdots(s-(d-1))}{d!} \\ &= \frac{1}{d \cdot (d-1) \cdots 2 \cdot 1} s(s-1)\cdots(s-(d-1)) \end{aligned}$$

takes integer values for any integer  $s$  (see Exercise 10). Further, in Exercises 11 and 12, you will show that any polynomial of degree  $d$  which takes integer values for sufficiently large integers  $s$  can be written uniquely as an integer linear combination of the polynomials

$$\begin{aligned} \binom{s}{0} = 1, \binom{s}{1} = s, \binom{s}{2} = \frac{s(s-1)}{2}, \dots, \\ \binom{s}{d} = \frac{s(s-1)\cdots(s-(d-1))}{d!}. \end{aligned}$$

Using this fact, we obtain the following sharpening of Theorem 6.

**Proposition 7.** *If  $I \subset k[x_1, \dots, x_n]$  is a monomial ideal with  $\dim \mathbf{V}(I) = d$ , then for all  $s$  sufficiently large, the number of points in  $C(I)$  of total degree  $\leq s$  is a polynomial of degree  $d$  in  $s$  which can be written in the form*

$$\sum_{i=0}^d a_i \binom{s}{d-i},$$

where  $a_i \in \mathbb{Z}$  for  $0 \leq i \leq d$  and  $a_0 > 0$ .

In the final part of this section, we will study the projective variety associated with a monomial ideal. This makes sense because every monomial ideal is homogeneous (see Exercise 13). Thus, a monomial ideal  $I \subset k[x_1, \dots, x_n]$  determines a projective variety  $\mathbf{V}_p(I) \subset \mathbb{P}^{n-1}(k)$ , where we use the subscript  $p$  to remind us that we are in projective space. In Exercise 14, you will show that  $\mathbf{V}_p(I)$  is a finite union of projective linear subspaces which have dimension one less than the *dimension* of their affine counterparts. As in the affine case, we define the *dimension* of a finite union of projective linear subspaces to be the maximum of the dimensions of the subspaces. Then Theorem 6 shows that the dimension of the projective variety  $\mathbf{V}_p(I)$  of a monomial ideal  $I$  is one less than the degree of the polynomial in  $s$  counting the number of monomials not in  $I$  of total degree  $\leq s$ .

In this case it turns out to be more convenient to consider the polynomial in  $s$  counting the number of monomials whose total degree is *equal* to  $s$ . The reason resides in the following proposition.

**Proposition 8.** *Let  $I \subset k[x_1, \dots, x_n]$  be a monomial ideal and let  $\mathbf{V}_p(I)$  be the projective variety in  $\mathbb{P}^{n-1}(k)$  defined by  $I$ . If  $\dim \mathbf{V}_p(I) = d - 1$ , then for all  $s$  sufficiently large, the number of monomials not in  $I$  of total degree  $s$  is given by a polynomial of*

the form

$$\sum_{i=0}^{d-1} b_i \binom{s}{d-1-i}$$

of degree  $d - 1$  in  $s$ , where  $b_i \in \mathbb{Z}$  for  $0 \leq i \leq d - 1$  and  $b_0 > 0$ .

**Proof.** As an affine variety,  $\mathbf{V}(I) \subset k^n$  has dimension  $d$ , so that by Theorem 6, the number of monomials not in  $I$  of total degree  $\leq s$  is a polynomial  $p(s)$  of degree  $d$  for  $s$  sufficiently large. We also know that the coefficient of  $s^d$  is positive. It follows that the number of monomials of total degree equal to  $s$  is given by

$$p(s) - p(s - 1)$$

for  $s$  large enough. In Exercise 15, you will show that this polynomial has degree  $d - 1$  and that the coefficient of  $s^{d-1}$  is positive. Since it also takes integer values when  $s$  is a sufficiently large integer, it follows from the remarks preceding Proposition 7 that  $p(s) - p(s - 1)$  has the desired form.  $\square$

In particular, this proposition says that for the projective variety defined by a monomial ideal, the dimension and the degree of the polynomial in the statement are equal. In §3, we will extend these results to the case of arbitrary homogeneous ideals  $I \subset k[x_1, \dots, x_n]$ .

### EXERCISES FOR §2

1. In this exercise, we will verify some of the claims made in Example 1. Remember that  $I \subset k[x, y]$  is a proper monomial ideal.
  - a. In case (b) of Example 1, show that if  $s > l$ , then the  $l$  “lines” of monomials contain  $l(s + 1) - (1 + 2 + \dots + l - 1)$  monomials of total degree  $\leq s$ .
  - b. In case (b), conclude that the number of monomials not in  $I$  of total degree  $\leq s$  is given by  $ls + C_0$  for  $s$  sufficiently large. Explain how to compute  $C_0$  and show that  $s > a + b$  guarantees that  $s$  is sufficiently large. Illustrate your answer with a picture that shows what can go wrong if  $s$  is too small.
  - c. In case (d) of Example 1, show that the constant  $C_0$  in the polynomial function giving the number of points in  $C(I)$  of total degree  $\leq s$  is equal to the finite number of monomials not contained in the “lines” of monomials, minus  $l \cdot k$  for the monomials belonging to both families of lines, minus  $1 + 2 + \dots + (l - 1)$ , minus  $1 + \dots + (k - 1)$ .
2. Let  $I \subset k[x_1, \dots, x_n]$  be a monomial ideal. Suppose that in  $\mathbb{Z}_{\geq 0}^n$ , the translate  $\alpha + [e_{i_1}, \dots, e_{i_r}]$  is contained in  $C(I)$ . If  $\alpha = \sum_{i \notin \{i_1, \dots, i_r\}} a_i e_i$ , show that  $C(I)$  contains all translates  $\beta + [e_{i_1}, \dots, e_{i_r}]$  for all  $\beta$  of the form  $\beta = \sum_{i \notin \{i_1, \dots, i_r\}} b_i e_i$ , where  $0 \leq b_i \leq a_i$  for all  $i$ . In particular,  $[e_{i_1}, \dots, e_{i_r}] \subset C(I)$ . Hint:  $I$  is an ideal.
3. In this exercise, you will find monomial ideals  $I \subset k[x, y, z]$  with a given  $C(I) \subset \mathbb{Z}_{\geq 0}^3$ .
  - a. Suppose that  $C(I)$  consists of one translate of  $[e_1, e_2]$  and two translates of  $[e_2, e_3]$ . Use Exercise 2 to show that  $C(I) = [e_1, e_2] \cup [e_2, e_3] \cup (e_1 + [e_2, e_3])$ .
  - b. Find a monomial ideal  $I$  so that  $C(I)$  is as described in part a. Hint: Study all monomials of small degree to see whether or not they lie in  $I$ .

- c. Suppose now that  $C(I)$  consists of one translate of  $[e_1, e_2]$ , two translates of  $[e_2, e_3]$ , and one additional translate (not contained in the others) of the line  $[e_2]$ . Use Exercise 2 to give a precise description of  $C(I)$ .
  - d. Find a monomial ideal  $I$  so that  $C(I)$  is as in part (c).
4. Let  $I$  be a monomial ideal in  $k[x, y, z]$ . In this exercise, we will study  $C(I) \subset \mathbb{Z}_{\geq 0}^3$ .
- a. Show that  $\mathbf{V}(I)$  must be one of the following possibilities: the origin; one, two, or three coordinate lines; one, two, or three coordinate planes; or the union of a coordinate plane and a perpendicular coordinate axis.
  - b. Show that if  $\mathbf{V}(I)$  contains only the origin, then  $C(I)$  has a finite number of points.
  - c. Show that if  $\mathbf{V}(I)$  is a union of one, two, or three coordinate lines, then  $C(I)$  consists of a finite number of translates of  $[e_1]$ ,  $[e_2]$ , and/or  $[e_3]$ , together with a finite number of points not on these translates.
  - d. Show that if  $\mathbf{V}(I)$  is a union of one, two or three coordinate planes, then  $C(I)$  consists of a finite number of translates of  $[e_1, e_2]$ ,  $[e_1, e_3]$ , and/or  $[e_2, e_3]$  plus, possibly, a finite number of translates of  $[e_1]$ ,  $[e_2]$ , and/or  $[e_3]$  (where a translate of  $[e_i]$  cannot occur unless  $[e_i, e_j] \subset C(I)$  for some  $j \neq i$ ) plus, possibly, a finite number of points not on these translates.
  - e. Finally, show that if  $\mathbf{V}(I)$  is the union of a coordinate plane and the perpendicular coordinate axis, then  $C(I)$  consists of a finite nonzero number of translates of a single coordinate plane  $[e_i, e_j]$ , plus a finite nonzero number of translates of  $[e_k]$ ,  $k \neq i, j$ , plus, possibly, a finite number of translates of  $[e_i]$  and/or  $[e_j]$ , plus a finite number of points not on any of these translates.
5. Show that the number of points in any  $m$ -dimensional coordinate subspace of  $\mathbb{Z}_{\geq 0}^n$  of total degree  $\leq s$  is given by  $\binom{m+s}{s}$ .
6. Prove part (ii) of Lemma 5.
7. In this exercise, you will develop a counting principle, called the Inclusion-Exclusion Principle. The idea is to give a general method for counting the number of elements in a union of finite sets. We will use the notation  $|A|$  for the number of elements in the finite set  $A$ .
- a. Show that for any two finite sets  $A$  and  $B$ .

$$|A \cup B| = |A| + |B| - |A \cap B|.$$

- b. Show that for any three finite sets  $A, B, C$ ,

$$|A \cup B \cup C| = |A| + |B| + |C| - |A \cap B| - |A \cap C| - |B \cap C| + |A \cap B \cap C|.$$

- c. Using induction on the number of sets, show that the number of elements in a union of  $n$  finite sets  $A_1 \cup \dots \cup A_n$  is equal to the sum of the  $|A_i|$ , minus the sum of all double intersections  $|A_i \cap A_j|$ ,  $i < j$ , plus the sum of all the threefold intersections  $|A_i \cap A_j \cap A_k|$ ,  $i < j < k$ , minus the sum of the fourfold intersections, etc. This can be written as the following formula:

$$|A_1 \cup \dots \cup A_n| = \sum_{r=1}^n (-1)^{r-1} \left( \sum_{1 \leq i_1 < \dots < i_r \leq n} |A_{i_1} \cap \dots \cap A_{i_r}| \right).$$

8. In this exercise, you will show that the intersection of two translates of different coordinate subspaces of  $\mathbb{Z}_{\geq 0}^n$  is a translate of a lower dimensional coordinate subspace.
- a. Let  $A = \alpha + [e_{i_1}, \dots, e_{i_m}]$ , where  $\alpha = \sum_{i \notin \{i_1, \dots, i_m\}} a_i e_i$ , and let  $B = \beta + [e_{j_1}, \dots, e_{j_r}]$ , where  $\beta = \sum_{i \notin \{j_1, \dots, j_r\}} b_i e_i$ . If  $A \neq B$  and  $A \cap B \neq \emptyset$ , then show that

$$[e_{i_1}, \dots, e_{i_m}] \neq [e_{j_1}, \dots, e_{j_r}]$$

and that  $A \cap B$  is a translate of

$$[e_{i_1}, \dots, e_{i_m}] \cap [e_{j_1}, \dots, e_{j_r}].$$

b. Deduce that  $\dim A \cap B < \max(m, r)$ .

9. Show that if  $s \geq 7$ , then the number of elements in  $C(I)$  of total degree  $\leq s$  for the monomial ideal  $I$  in the example following Theorem 6 is given by the polynomial  $5s - 1$ .
10. Show that the polynomial

$$p(s) = \binom{s}{d} = \frac{s(s-1) \cdots (s-(d-1))}{d!}$$

takes integer values for all integers  $s$ . Note that  $p$  is a polynomial of degree  $d$  in  $s$ .

11. In this exercise, we will show that every polynomial  $p(s)$  of degree  $\leq d$  which takes integer values for every  $s \in \mathbb{Z}_{\geq 0}$  can be written as a unique linear combination with integer coefficients of the polynomials  $\binom{s}{0}, \binom{s}{1}, \binom{s}{2}, \dots, \binom{s}{d}$ .

a. Show that the polynomials

$$\binom{s}{0}, \binom{s}{1}, \binom{s}{2}, \dots, \binom{s}{d}$$

are linearly independent in the sense that

$$a_0 \binom{s}{0} + a_1 \binom{s}{1} + \cdots + a_d \binom{s}{d} = 0$$

for all  $s$  implies that  $a_0 = a_1 = \cdots = a_d = 0$ .

- b. Show that any two polynomials  $p(s)$  and  $q(s)$  of degree  $\leq d$  which take the same values at the  $d + 1$  points  $s = 0, 1, \dots, d$  must be identical. Hint: How many roots does the polynomial  $p(s) - q(s)$  have?
- c. Suppose we want to construct a polynomial  $p(s)$  that satisfies

$$(3) \quad \begin{aligned} p(0) &= c_0, \\ p(1) &= c_1, \\ &\vdots \\ p(d) &= c_d, \end{aligned}$$

where the  $c_i$  are given values in  $\mathbb{Z}$ . Show that if we set

$$\begin{aligned} \Delta_0 &= c_0, \\ \Delta_1 &= c_1 - c_0, \\ \Delta_2 &= c_2 - 2c_1 + c_0, \\ &\vdots \\ \Delta_d &= \sum_{n=0}^d (-1)^n \binom{d}{n} c_{d-n}, \end{aligned}$$

then the polynomial

$$(4) \quad p(s) = \Delta_0 \binom{s}{0} + \Delta_1 \binom{s}{1} + \cdots + \Delta_d \binom{s}{d}$$

satisfies the equations in (3). Hint: Argue by induction on  $d$ . [The polynomial in (4) is called a Newton–Gregory interpolating polynomial.]



- d. Explain why the polynomial in (4) takes integer values for all integer  $s$ . Hint: Recall that the  $c_i$  in (3) are integers. See also Exercise 10.
- e. Deduce from parts (a)–(d) that every polynomial of degree  $d$  which takes integer values for all integer  $s \geq 0$  can be written as a unique integer linear combination of  $\binom{s}{0}, \dots, \binom{s}{d}$ .
12. Suppose that  $p(s)$  is a polynomial of degree  $d$  which takes integer values when  $s$  is a sufficiently large integer, say  $s \geq a$ . We want to prove that  $p(s)$  is an integer linear combination of the polynomials  $\binom{s}{0}, \dots, \binom{s}{d}$  studied in Exercises 10 and 11. We can assume that  $a$  is a positive integer.
- a. Show that the polynomial  $p(s+a)$  can be expressed in terms of  $\binom{s}{0}, \dots, \binom{s}{d}$  and conclude that  $p(s)$  is an integer linear combination of  $\binom{s-a}{0}, \dots, \binom{s-a}{d}$ .
- b. Use Exercise 10 to show that  $p(s)$  takes integer values for all  $s \in \mathbb{Z}$  and conclude that  $p(s)$  is an integer linear combination of  $\binom{s}{0}, \dots, \binom{s}{d}$ .
13. Show that every monomial ideal is a homogeneous ideal.
14. Let  $I \subset k[x_1, \dots, x_n]$  be a monomial ideal.
- a. In  $k^n$ , let  $\mathbf{V}(x_{i_1}, \dots, x_{i_r})$  be a coordinate subspace of dimension  $n-r$  contained in  $\mathbf{V}(I)$ . Prove that  $\mathbf{V}_p(x_{i_1}, \dots, x_{i_r}) \subset \mathbf{V}_p(I)$  in  $\mathbb{P}^{n-1}(k)$ . Also show that  $\mathbf{V}_p(x_{i_1}, \dots, x_{i_r})$  looks like a copy of  $\mathbb{P}^{n-r-1}$  sitting inside  $\mathbb{P}^{n-1}$ . Thus, we say that  $\mathbf{V}_p(x_{i_1}, \dots, x_{i_r})$  is a projective linear subspace of dimension  $n-r-1$ .
- b. Prove the claim made in the text that  $\mathbf{V}_p(I)$  is a finite union of projective linear subspaces of dimension one less than their affine counterparts.
15. Verify the statement in the proof of Proposition 8 that if  $p(s)$  is a polynomial of degree  $d$  in  $s$  with a positive coefficient of  $s^d$ , then  $p(s) - p(s-1)$  is a polynomial of degree  $d-1$  with a positive coefficient of  $s^{d-1}$ .

### §3 The Hilbert Function and the Dimension of a Variety

In this section, we will define the Hilbert function of an ideal  $I$  and use it to define the dimension of a variety  $V$ . We will give the basic definitions in both the affine and projective cases. The basic idea will be to use the experience gained in the last section and define dimension in terms of the number of monomials not contained in the ideal  $I$ . In the affine case, we will use the number of monomials not in  $I$  of total degree  $\leq s$ , whereas in the projective case, we consider those of total degree *equal* to  $s$ .

However, we need to note from the outset that the results from §2 do not apply directly because when  $I$  is not a monomial ideal, different monomials not in  $I$  can be dependent on one another. For instance, if  $I = (x^2 - y^2)$ , neither the monomial  $x^2$  nor  $y^2$  belongs to  $I$ , but their difference does. So we should not regard  $x^2$  and  $y^2$  as two monomials not in  $I$ . Rather, to generalize §2, we will need to consider the number of monomials of total degree  $\leq s$  which are “linearly independent modulo”  $I$ .

In Chapter 5, we defined the quotient of a ring modulo an ideal. There is an analogous operation on vector spaces which we will use to make the above ideas precise. Given a vector space  $V$  and a subspace  $W \subset V$ , it is not difficult to show that the relation on  $V$  defined by  $v \sim v'$  if  $v - v' \in W$  is an equivalence relation (see Exercise 1). The set of equivalence classes of  $\sim$  is denoted  $V/W$ , so that

$$V/W = \{[v] : v \in V\}.$$

In the exercises, you will check that the operations  $[v] + [v'] = [v + v']$  and  $a[v] = [av]$ , where  $a \in k$  and  $v, v' \in V$  are well-defined and make  $V/W$  into a  $k$ -vector space, called the *quotient space* of  $V$  modulo  $W$ .

When  $V$  is finite-dimensional, we can compute the dimension of  $V/W$  as follows.

**Proposition 1.** *Let  $W$  be a subspace of a finite-dimensional vector space  $V$ . Then  $W$  and  $V/W$  are also finite-dimensional vector spaces, and*

$$\dim V = \dim W + \dim V/W.$$

**Proof.** If  $V$  is finite-dimensional, it is a standard fact from linear algebra that  $W$  is also finite-dimensional. Let  $v_1, \dots, v_m$  be a basis of  $W$ , so that  $\dim W = m$ . In  $V$ , the vectors  $v_1, \dots, v_m$  are linearly independent and, hence, can be extended to a basis  $v_1, \dots, v_m, v_{m+1}, \dots, v_{m+n}$  of  $V$ . Thus,  $\dim V = m + n$ . We claim that  $[v_{m+1}], \dots, [v_{m+n}]$  form a basis of  $V/W$ .

To see that they span, take  $[v] \in V/W$ . If we write  $v = \sum_{i=1}^{m+n} a_i v_i$ , then  $v \sim a_{m+1}v_{m+1} + \dots + a_{m+n}v_{m+n}$  since their difference is  $a_1v_1 + \dots + a_mv_m \in W$ . It follows that in  $V/W$ , we have

$$[v] = [a_{m+1}v_{m+1} + \dots + a_{m+n}v_{m+n}] = a_{m+1}[v_{m+1}] + \dots + a_{m+n}[v_{m+n}].$$

The proof that  $[v_{m+1}], \dots, [v_{m+n}]$  are linearly independent is left to the reader (see Exercise 2). This proves the claim, and the proposition follows immediately.  $\square$

### *The Dimension of an Affine Variety*

Considered as a vector space over  $k$ , the polynomial ring  $k[x_1, \dots, x_n]$  has infinite dimension, and the same is true for any nonzero ideal (see Exercise 3). To get something finite-dimensional, we will restrict ourselves to polynomials of total degree  $\leq s$ . Hence, we let

$$k[x_1, \dots, x_n]_{\leq s}$$

denote the set of polynomials of total degree  $\leq s$  in  $k[x_1, \dots, x_n]$ . By Lemma 4 of §2, it follows that  $k[x_1, \dots, x_n]_{\leq s}$  is a vector space of dimension  $\binom{n+s}{s}$ . Then, given an ideal  $I \subset k[x_1, \dots, x_n]$ , we let

$$I_{\leq s} = I \cap k[x_1, \dots, x_n]_{\leq s}$$

denote the set of polynomials in  $I$  of total degree  $\leq s$ . Note that  $I_{\leq s}$  is a vector subspace of  $k[x_1, \dots, x_n]_{\leq s}$ . We are now ready to define the affine Hilbert function of  $I$ .

**Definition 2.** *Let  $I$  be an ideal in  $k[x_1, \dots, x_n]$ . The **affine Hilbert function** of  $I$  is the function on the nonnegative integers  $s$  defined by*

$$\begin{aligned} {}^aHF_I(s) &= \dim k[x_1, \dots, x_n]_{\leq s} / I_{\leq s} \\ &= \dim k[x_1, \dots, x_n]_{\leq s} - \dim I_{\leq s} \end{aligned}$$

(where the second equality is by Proposition 1).

With this terminology, the results of §2 for monomial ideals can be restated as follows.

**Proposition 3.** *Let  $I$  be a proper monomial ideal in  $k[x_1, \dots, x_n]$ .*

- (i) *For all  $s \geq 0$ ,  ${}^a\text{HF}_I(s)$  is the number of monomials not in  $I$  of total degree  $\leq s$ .*
- (ii) *For all  $s$  sufficiently large, the affine Hilbert function of  $I$  is given by a polynomial function*

$${}^a\text{HF}_I(s) = \sum_{i=0}^d b_i \binom{s}{d-i},$$

where  $b_i \in \mathbb{Z}$  and  $b_0$  is positive.

- (iii) *The degree of the polynomial in part (ii) is the maximum of the dimensions of the coordinate subspaces contained in  $\mathbf{V}(I)$ .*

**Proof.** To prove (i), first note that  $\{x^\alpha : |\alpha| \leq s\}$  is a basis of  $k[x_1, \dots, x_n]_{\leq s}$  as a vector space over  $k$ . Further, Lemma 3 of Chapter 2, §4 shows that  $\{x^\alpha : |\alpha| \leq s, x^\alpha \in I\}$  is a basis of  $I_{\leq s}$ . Consequently, the monomials in  $\{x^\alpha : |\alpha| \leq s, x^\alpha \notin I\}$  are exactly what we add to a basis of  $I_{\leq s}$  to get a basis of  $k[x_1, \dots, x_n]_{\leq s}$ . It follows from the proof of Proposition 1 that  $\{[x^\alpha] : |\alpha| \leq s, x^\alpha \notin I\}$  is a basis of the quotient space  $k[x_1, \dots, x_n]_{\leq s}/I_{\leq s}$ , which completes the proof of (i).

Parts (ii) and (iii) follow easily from (i) and Proposition 7 of §2. □

We are now ready to link the ideals of §2 to arbitrary ideals in  $k[x_1, \dots, x_n]$ . The key ingredient is the following observation due to Macaulay. As in Chapter 8, §4, we say that a monomial order  $>$  on  $k[x_1, \dots, x_n]$  is a *graded order* if  $x^\alpha > x^\beta$  whenever  $|\alpha| > |\beta|$ .

**Proposition 4.** *Let  $I \subset k[x_1, \dots, x_n]$  be an ideal and let  $>$  be a graded order on  $k[x_1, \dots, x_n]$ . Then the monomial ideal  $\langle \text{LT}(I) \rangle$  has the same affine Hilbert function as  $I$ .*

**Proof.** Fix  $s$  and consider the leading monomials  $\text{LM}(f)$  of all elements  $f \in I_{\leq s}$ . There are only finitely many such monomials, so that

$$(1) \quad \{\text{LM}(f) : f \in I_{\leq s}\} = \{\text{LM}(f_1), \dots, \text{LM}(f_m)\}$$

for some polynomials  $f_1, \dots, f_m \in I_{\leq s}$ . By rearranging and deleting duplicates, we can assume that  $\text{LM}(f_1) > \text{LM}(f_2) > \dots > \text{LM}(f_m)$ . We claim that  $f_1, \dots, f_m$  are a basis of  $I_{\leq s}$  as a vector space over  $k$ .

To prove this, consider a nontrivial linear combination  $a_1 f_1 + \dots + a_m f_m$  and choose the smallest  $i$  such that  $a_i \neq 0$ . Given how we ordered the leading monomials, there is nothing to cancel  $a_i \text{LT}(f_i)$ , so the linear combination is nonzero. Hence,  $f_1, \dots, f_m$  are linearly independent. Next, let  $W = [f_1, \dots, f_m] \subset I_{\leq s}$  be the subspace spanned by  $f_1, \dots, f_m$ . If  $W \neq I_{\leq s}$ , pick  $f \in I_{\leq s} - W$  with  $\text{LM}(f)$  minimal. By (1),  $\text{LM}(f) = \text{LM}(f_i)$  for some  $i$ , and hence,  $\text{LT}(f) = \lambda \text{LT}(f_i)$  for some  $\lambda \in k$ . Then  $f - \lambda f_i \in I_{\leq s}$  has a smaller leading monomial, so that  $f - \lambda f_i \in W$  by the

minimality of  $\text{LM}(f)$ . This implies  $f \in W$ , which is a contradiction. It follows that  $W = [f_1, \dots, f_m] = I_{\leq s}$ , and we conclude that  $f_1, \dots, f_m$  are a basis.

The monomial ideal  $\langle \text{LT}(I) \rangle$  is generated by the leading terms (or leading monomials) of elements of  $I$ . Thus,  $\text{LM}(f_i) \in \langle \text{LT}(I) \rangle_{\leq s}$  since  $f_i \in I_{\leq s}$ . We claim that  $\text{LM}(f_1), \dots, \text{LM}(f_m)$  are a vector space basis of  $\langle \text{LT}(I) \rangle_{\leq s}$ . Arguing as above, it is easy to see that they are linearly independent. It remains to show that they span, i.e., that  $[\text{LM}(f_1), \dots, \text{LM}(f_m)] = \langle \text{LT}(I) \rangle_{\leq s}$ . By Lemma 3 of Chapter 2, §4, it suffices to show that

$$(2) \quad \{\text{LM}(f_1), \dots, \text{LM}(f_m)\} = \{\text{LM}(f) : f \in I, \text{LM}(f) \text{ has total degree } \leq s\}.$$

To relate this to (1), note that  $>$  is a graded order, which implies that for any nonzero polynomial  $f \in k[x_1, \dots, x_n]$ ,  $\text{LM}(f)$  has the same total degree as  $f$ . In particular, if  $\text{LM}(f)$  has total degree  $\leq s$ , then so does  $f$ , which means that (2) follows immediately from (1).

Thus,  $I_{\leq s}$  and  $\langle \text{LT}(I) \rangle_{\leq s}$  have the same dimension (since they both have bases consisting of  $m$  elements), and then the dimension formula of Proposition 1 implies that

$$\begin{aligned} {}^a\text{HF}_I(s) &= \dim k[x_1, \dots, x_n]_{\leq s} / I_{\leq s} \\ &= \dim k[x_1, \dots, x_n]_{\leq s} / \langle \text{LT}(I) \rangle_{\leq s} = {}^a\text{HF}_{\langle \text{LT}(I) \rangle}(s). \end{aligned}$$

This proves the proposition. □

If we combine Propositions 3 and 4, it follows immediately that if  $I$  is any ideal in  $k[x_1, \dots, x_n]$  and  $s$  is sufficiently large, the affine Hilbert function of  $I$  can be written

$${}^a\text{HF}_I(s) = \sum_{i=0}^d b_i \binom{s}{d-i},$$

where the  $b_i$  are integers and  $b_0$  is positive. This leads to the following definition.

**Definition 5.** *The polynomial which equals  ${}^a\text{HF}_I(s)$  for sufficiently large  $s$  is called the **affine Hilbert polynomial** of  $I$  and is denoted  ${}^a\text{HP}_I(s)$ .*

As an example, consider the ideal  $I = \langle x^3y^2 + 3x^2y^2 + y^3 + 1 \rangle \subset k[x, y]$ . If we use grlex order, then  $\langle \text{LT}(I) \rangle = \langle x^3y^2 \rangle$ , and using the methods of §2, one can show that the number of monomials not in  $\langle \text{LT}(I) \rangle$  of total degree  $\leq s$  equals  $5s - 5$  when  $s \geq 3$ . From Propositions 3 and 4, we obtain

$${}^a\text{HF}_I(s) = {}^a\text{HF}_{\langle \text{LT}(I) \rangle}(s) = 5s - 5$$

when  $s \geq 3$ . It follows that the affine Hilbert polynomial of  $I$  is

$${}^a\text{HP}_I(s) = 5s - 5.$$

By definition, the affine Hilbert function of an ideal  $I$  coincides with the affine Hilbert polynomial of  $I$  when  $s$  is sufficiently large. The smallest integer  $s_0$  such that  ${}^a\text{HP}_I(s) = {}^a\text{HF}_I(s)$  for all  $s \geq s_0$  is called the *index of regularity* of  $I$ . Determining the index of

regularity is of considerable interest and importance in many computations with ideals, but we will not pursue this topic in detail here.

We next compare the degrees of the affine Hilbert polynomials for  $I$  and  $\sqrt{I}$ .

**Proposition 6.** *If  $I \subset k[x_1, \dots, x_n]$  is an ideal, then the affine Hilbert polynomials of  $I$  and  $\sqrt{I}$  have the same degree.*

**Proof.** For a monomial ideal  $I$ , we know that the degree of the affine Hilbert polynomial is the dimension of the largest coordinate subspace of  $k^n$  contained in  $\mathbf{V}(I)$ . Since  $\sqrt{I}$  is monomial by Exercise 9 of §1 and  $\mathbf{V}(I) = \mathbf{V}(\sqrt{I})$ , it follows immediately that  ${}^a\text{HP}_I$  and  ${}^a\text{HP}_{\sqrt{I}}$  have the same degree.

Now let  $I$  be an arbitrary ideal in  $k[x_1, \dots, x_n]$  and pick any graded order  $>$  in  $k[x_1, \dots, x_n]$ . We claim that

$$(3) \quad \langle \text{LT}(I) \rangle \subset \langle \text{LT}(\sqrt{I}) \rangle \subset \sqrt{\langle \text{LT}(I) \rangle}.$$

The first containment is immediate from  $I \subset \sqrt{I}$ . To establish the second, let  $x^\alpha$  be a monomial in  $\text{LT}(\sqrt{I})$ . This means that there is a polynomial  $f \in \sqrt{I}$  such that  $\text{LT}(f) = x^\alpha$ . We know  $f^r \in I$  for some  $r \geq 0$ , and it follows that  $x^{r\alpha} = \text{LT}(f^r) \in \langle \text{LT}(I) \rangle$ . Thus,  $x^\alpha \in \sqrt{\langle \text{LT}(I) \rangle}$ .

In Exercise 8, we will prove that if  $I_1 \subset I_2$  are any ideals of  $k[x_1, \dots, x_n]$ , then  $\text{deg } {}^a\text{HP}_{I_2} \leq \text{deg } {}^a\text{HP}_{I_1}$ . If we apply this fact to (3), we obtain the inequalities

$$\text{deg } {}^a\text{HP}_{\sqrt{\langle \text{LT}(I) \rangle}} \leq \text{deg } {}^a\text{HP}_{\langle \text{LT}(\sqrt{I}) \rangle} \leq \text{deg } {}^a\text{HP}_{\langle \text{LT}(I) \rangle}.$$

By the result for monomial ideals, the two outer terms here are equal and we conclude that  ${}^a\text{HP}_{\langle \text{LT}(I) \rangle}$  and  ${}^a\text{HP}_{\langle \text{LT}(\sqrt{I}) \rangle}$  have the same degree. By Proposition 4, the same is true for  ${}^a\text{HP}_I$  and  ${}^a\text{HP}_{\sqrt{I}}$ , and the proposition is proved.  $\square$

This proposition is evidence of something that is not at all obvious, namely, that the degree of the affine Hilbert polynomial has *geometric* meaning in addition to its *algebraic* significance in indicating how far  $I_{\leq s}$  is from being all of  $k[x_1, \dots, x_n]_{\leq s}$ . Recall that  $\mathbf{V}(I) = \mathbf{V}(\sqrt{I})$  for all ideals. Thus, the degree of the affine Hilbert polynomial is the same for a large collection of ideals defining the same variety. Moreover, we know from §2 that the degree of the affine Hilbert polynomial is the same as our intuitive notion of the dimension of the variety of a monomial ideal. So it should be no surprise that in the general case, we define dimension in terms of the degree of the affine Hilbert function. We will always assume that the field  $k$  is infinite.

**Definition 7.** *The dimension of an affine variety  $V \subset k^n$ , denoted  $\dim V$ , is the degree of the affine Hilbert polynomial of the corresponding ideal  $I = \mathbf{I}(V) \subset k[x_1, \dots, x_n]$ .*

As an example, consider the twisted cubic  $V = \mathbf{V}(y - x^2, z - x^3) \subset \mathbb{R}^3$ . In Chapter 1, we showed that  $I = \mathbf{I}(V) = \langle y - x^2, z - x^3 \rangle \subset \mathbb{R}[x, y, z]$ . Using grlex order, a Groebner basis for  $I$  is  $\{y^3 - z^2, x^2 - y, xy - z, xz - y^2\}$ , so that  $\langle \text{LT}(I) \rangle =$

$\langle y^3, x^2, xy, xz \rangle$ . Then

$$\begin{aligned} \dim V &= \deg {}^aHP_I \\ &= \deg {}^aHP_{(\text{LT}(I))} \\ &= \text{maximum dimension of a coordinate subspace in } \mathbf{V}(\langle \text{LT}(I) \rangle) \end{aligned}$$

by Propositions 3 and 4. Since

$$\mathbf{V}(\langle \text{LT}(I) \rangle) = \mathbf{V}(y^3, x^2, xy, xz) = \mathbf{V}(x, y) \subset \mathbb{R}^3,$$

we conclude that  $\dim V = 1$ . This agrees with our intuition that the twisted cubic should be 1-dimensional since it is a curve in  $\mathbb{R}^3$ .

For another example, let us compute the dimension of the variety of a monomial ideal. In Exercise 10, you will show that  $\mathbf{I}(\mathbf{V}(I)) = \sqrt{I}$  when  $I$  is a monomial ideal and  $k$  is infinite. Then Proposition 6 implies that

$$\dim \mathbf{V}(I) = \deg {}^aHP_{\mathbf{I}(\mathbf{V}(I))} = \deg {}^aHP_{\sqrt{I}} = \deg {}^aHP_I,$$

and it follows from part (iii) of Proposition 3 that  $\dim \mathbf{V}(I)$  is the maximum dimension of a coordinate subspace contained in  $\mathbf{V}(I)$ . This agrees with the provisional definition of dimension given in §2. In Exercise 10, you will see that this can fail when  $k$  is a finite field.

An interesting exceptional case is the empty variety. Note that  $1 \in \mathbf{I}(V)$  if and only if  $k[x_1, \dots, x_n]_{\leq s} = \mathbf{I}(V)_{\leq s}$  for all  $s$ . Hence,

$$V = \emptyset \iff {}^aHP_{\mathbf{I}(V)} = 0.$$

Since the zero polynomial does not have a degree, we do not assign a dimension to the empty variety.

One drawback of Definition 7 is that to find the dimension of a variety  $V$ , we need to know  $\mathbf{I}(V)$ , which, in general, is difficult to compute. It would be much nicer if  $\dim V$  were the degree of  ${}^aHP_I$ , where  $I$  is an arbitrary ideal defining  $V$ . Unfortunately, this is not true in general. For example, if  $I = \langle x^2 + y^2 \rangle \subset \mathbb{R}[x, y]$ , it is easy to check that  ${}^aHP_I(s)$  has degree 1. Yet  $V = \mathbf{V}(I) = \{(0, 0)\} \subset \mathbb{R}^2$  is easily seen to have dimension 0. Thus,  $\dim \mathbf{V}(I) \neq \deg {}^aHP_I$  in this case (see Exercise 11 for the details).

When the field  $k$  is algebraically closed, these difficulties go away. More precisely, we have the following theorem that tells us how to compute the dimension in terms of any defining ideal.

**Theorem 8 (The Dimension Theorem).** *Let  $V = \mathbf{V}(I)$  be an affine variety, where  $I \subset k[x_1, \dots, x_n]$  is an ideal. If  $k$  is algebraically closed, then*

$$\dim V = \deg {}^aHP_I.$$

Furthermore, if  $>$  is a graded order on  $k[x_1, \dots, x_n]$ , then

$$\begin{aligned} \dim V &= \deg {}^aHP_{(\text{LT}(I))} \\ &= \text{maximum dimension of a coordinate subspace in } \mathbf{V}(\langle \text{LT}(I) \rangle). \end{aligned}$$

Finally, the last two equalities hold over any field  $k$  when  $I = \mathbf{I}(V)$ .

**Proof.** Since  $k$  is algebraically closed, the Nullstellensatz implies that  $\mathbf{I}(V) = \sqrt{\mathbf{I}(I)}$ . Then

$$\dim V = \deg {}^aHP_{\mathbf{I}(V)} = \deg {}^aHP_{\sqrt{I}} = \deg {}^aHP_I,$$

where the last equality is by Proposition 6. The second part of the theorem now follows immediately using Propositions 3 and 4.  $\square$

In other words, over an algebraically closed field, to compute the dimension of a variety  $V = \mathbf{V}(I)$ , one can proceed as follows:

- Compute a Groebner basis for  $I$  using a graded order such as grlex or grevlex.
- Compute the maximal dimension  $d$  of a coordinate subspace contained in  $\mathbf{V}(\langle \text{LT}(I) \rangle)$ .

Note that Proposition 3 of §1 gives an algorithm for doing this.

Then  $\dim V = d$  follows from Theorem 8.

### The Dimension of a Projective Variety

Our discussion of the dimension of a projective variety  $V \subset \mathbb{P}^n(k)$  will parallel what we did in the affine case and, in particular, many of the arguments are the same. We start by defining the Hilbert function and the Hilbert polynomial for an arbitrary homogeneous ideal  $I \subset k[x_0, \dots, x_n]$ . As above, we assume that  $k$  is infinite.

As we saw in §2, the projective case uses total degree equal to  $s$  rather than  $\leq s$ . Since polynomials of total degree  $s$  do not form a vector space (see Exercise 13), we will work with *homogeneous* polynomials of total degree  $s$ . Let

$$k[x_0, \dots, x_n]_s$$

denote the set of homogeneous polynomials of total degree  $s$  in  $k[x_0, \dots, x_n]$ , together with the zero polynomial. In Exercise 13, you will show that  $k[x_0, \dots, x_n]_s$  is a vector space of dimension  $\binom{n+s}{s}$ . If  $I \subset k[x_0, \dots, x_n]$  is a homogeneous ideal, we let

$$I_s = I \cap k[x_0, \dots, x_n]_s$$

denote the set of homogeneous polynomials in  $I$  of total degree  $s$  (and the zero polynomial). Note that  $I_s$  is a vector subspace of  $k[x_0, \dots, x_n]_s$ . Then the *Hilbert function* of  $I$  is defined by

$$HF_I(s) = \dim k[x_0, \dots, x_n]_s / I_s.$$

Strictly speaking, we should call this the projective Hilbert function, but the above terminology is customary in algebraic geometry.

When  $I$  is a monomial ideal, the argument of Proposition 3 adapts easily to show that  $HF_I(s)$  is the number of monomials not in  $I$  of total degree  $s$ . It follows from Proposition 8 of §2 that for  $s$  sufficiently large, we can express the Hilbert function of a monomial ideal in the form

$$(4) \quad HF_I(s) = \sum_{i=0}^d b_i \binom{s}{d-i},$$

where  $b_i \in \mathbb{Z}$  and  $b_0$  is positive. We also know that  $d$  is the largest dimension of a projective coordinate subspace contained in  $\mathbf{V}(I) \subset \mathbb{P}^n(k)$ .

As in the affine case, we can use a monomial order to link the Hilbert function of a homogeneous ideal to the Hilbert function of a monomial ideal.

**Proposition 9.** *Let  $I \subset k[x_0, \dots, x_n]$  be a homogeneous ideal and let  $>$  be a monomial order on  $k[x_0, \dots, x_n]$ . Then the monomial ideal  $\langle \text{LT}(I) \rangle$  has the same Hilbert function as  $I$ .*

**Proof.** The argument is similar to the proof of Proposition 4. However, since we do not require that  $>$  be a graded order, some changes are needed.

For a fixed  $s$ , we can find  $f_1, \dots, f_m \in I_s$  such that

$$(5) \quad \{\text{LM}(f) : f \in I_s\} = \{\text{LM}(f_1), \dots, \text{LM}(f_m)\}$$

and we can assume that  $\text{LM}(f_1) > \text{LM}(f_2) > \dots > \text{LM}(f_m)$ . As in the proof of Proposition 4,  $f_1, \dots, f_m$  form a basis of  $I_s$  as a vector space over  $k$ .

Now consider  $\langle \text{LT}(I) \rangle_s$ . We know  $\text{LM}(f_i) \in \langle \text{LT}(I) \rangle_s$  since  $f_i \in I_s$  and we need to show that  $\text{LM}(f_1), \dots, \text{LM}(f_m)$  form a vector space basis of  $\langle \text{LT}(I) \rangle_s$ . The leading terms are distinct, so as above, they are linearly independent. It remains to prove that they span. By Lemma 3 of Chapter 2, §4, it suffices to show that

$$(6) \quad \{\text{LM}(f_1), \dots, \text{LM}(f_m)\} = \{\text{LM}(f) : f \in I, \text{LM}(f) \text{ has total degree } s\}.$$

To relate this to (5), suppose that  $\text{LM}(f)$  has total degree  $s$  for some  $f \in I$ . If we write  $f$  as a sum of homogeneous polynomials  $f = \sum_i h_i$ , where  $h_i$  has total degree  $i$ , it follows that  $\text{LM}(f) = \text{LM}(h_s)$ . Since  $I$  is a homogeneous ideal, we have  $h_s \in I$ . Thus,  $\text{LM}(f) = \text{LM}(h_s)$  where  $h_s \in I_s$ , and, consequently, (6) follows from (5). From here, the argument is identical to what we did in Proposition 4, and we are done.  $\square$

If we combine Proposition 9 with the description of the Hilbert function for a monomial ideal given by (4), we see that for any homogeneous ideal  $I \subset k[x_0, \dots, x_n]$ , the Hilbert function can be written

$$HF_I(s) = \sum_{i=0}^d b_i \binom{s}{d-i}$$

for  $s$  sufficiently large. The polynomial on the right of this equation is called the *Hilbert polynomial* of  $I$  and is denoted  $HP_I(s)$ .

We then define the dimension of a projective variety in terms of the Hilbert polynomial as follows.

**Definition 10.** *The **dimension** of a projective variety  $V \subset \mathbb{P}^n(k)$ , denoted  $\dim V$ , is the degree of the Hilbert polynomial of the corresponding homogeneous ideal  $I = \mathbf{I}(V) \subset k[x_0, \dots, x_n]$ . (Note that  $I$  is homogeneous by Proposition 4 of Chapter 8, §3.)*

Over an algebraically closed field, we can compute the dimension as follows.



**Theorem 11 (The Dimension Theorem).** *Let  $V = \mathbf{V}(I) \subset \mathbb{P}^n(k)$  be a projective variety, where  $I \subset k[x_0, \dots, x_n]$  is a homogeneous ideal. If  $V$  is nonempty and  $k$  is algebraically closed, then*

$$\dim V = \deg HP_I.$$

*Furthermore, for any monomial order on  $k[x_0, \dots, x_n]$ , we have*

$$\begin{aligned} \dim V &= \deg HP_{\langle \text{LT}(I) \rangle} \\ &= \text{maximum dimension of a projective coordinate subspace in } \mathbf{V}(\langle \text{LT}(I) \rangle). \end{aligned}$$

*Finally, the last two equalities hold over any field  $k$  when  $I = \mathbf{I}(V)$ .*

**Proof.** The first step is to show that  $I$  and  $\sqrt{I}$  have Hilbert polynomials of the same degree. The proof is similar to what we did in Proposition 6 and is left as an exercise.

By the projective Nullstellensatz, we know that  $\mathbf{I}(V) = \mathbf{I}(\mathbf{V}(I)) = \sqrt{I}$ , and, from here, the proof is identical to what we did in the affine case (see Theorem 8).  $\square$

For our final result, we compare the dimension of affine and projective varieties.

**Theorem 12.**

(i) *Let  $I \subset k[x_0, \dots, x_n]$  be a homogeneous ideal. Then, for  $s \geq 1$ , we have*

$$HF_I(s) = {}^aHF_I(s) - {}^aHF_I(s - 1).$$

*There is a similar relation between Hilbert polynomials. Consequently, if  $V \subset \mathbb{P}^n(k)$  is a nonempty projective variety and  $C_V \subset k^{n+1}$  is its affine cone (see Chapter 8, §3), then*

$$\dim C_V = \dim V + 1.$$

(ii) *Let  $I \subset k[x_1, \dots, x_n]$  be an ideal and let  $I^h \subset k[x_0, \dots, x_n]$  be its homogenization with respect to  $x_0$  (see §4 of Chapter 8). Then for  $s \geq 0$ , we have*

$${}^aHF_I(s) = HF_{I^h}(s).$$

*There is a similar relation between Hilbert polynomials. Consequently, if  $V \subset k^n$  is an affine variety and  $\overline{V} \subset \mathbb{P}^n(k)$  is its projective closure (see Chapter 8, §4), then*

$$\dim V = \dim \overline{V}.$$

**Proof.** We will use the subscripts  $a$  and  $p$  to indicate the affine and projective cases respectively. The first part of (i) follows easily by reducing to the case of a monomial ideal and using the results of §2. We leave the details as an exercise. For the second part of (i), note that the affine cone  $C_V$  is simply the affine variety in  $k^{n+1}$  defined by  $\mathbf{I}_p(V)$ . Further, it is easy to see that  $\mathbf{I}_a(C_V) = \mathbf{I}_p(V)$  (see Exercise 19). Thus, the dimensions of  $V$  and  $C_V$  are the degrees of  $HP_{\mathbf{I}_p(V)}$  and  ${}^aHP_{\mathbf{I}_p(V)}$ , respectively. Then  $\dim C_V = \dim V + 1$  follows from Exercise 15 of §2 and the relation just proved between the Hilbert polynomials.

To prove the first part of (ii), consider the maps

$$\begin{aligned}\phi &: k[x_1, \dots, x_n]_{\leq s} \longrightarrow k[x_0, \dots, x_n]_s, \\ \psi &: k[x_0, \dots, x_n]_s \longrightarrow k[x_1, \dots, x_n]_{\leq s}\end{aligned}$$

defined by the formulas

$$(7) \quad \begin{aligned}\phi(f) &= x_0^s f\left(\frac{x_1}{x_0}, \dots, \frac{x_n}{x_0}\right) \quad \text{for } f \in k[x_1, \dots, x_n]_{\leq s}, \\ \psi(F) &= F(1, x_1, \dots, x_n) \quad \text{for } F \in k[x_0, \dots, x_n]_s.\end{aligned}$$

We leave it as an exercise to check that these are linear maps that are inverses of each other, and hence,  $k[x_1, \dots, x_n]_{\leq s}$  and  $k[x_0, \dots, x_n]_s$  are isomorphic vector spaces. You should also check that if  $f \in k[x_1, \dots, x_n]_{\leq s}$  has total degree  $d \leq s$ , then

$$\phi(f) = x_0^{s-d} f^h,$$

where  $f^h$  is the homogenization of  $f$  as defined in Proposition 7 of Chapter 8, §2.

Under these linear maps, you will check in the exercises that

$$(8) \quad \begin{aligned}\phi(I_{\leq s}) &\subset I_s^h, \\ \psi(I_s^h) &\subset I_{\leq s},\end{aligned}$$

and it follows easily that the above inclusions are equalities. Thus,  $I_{\leq s}$  and  $I_s^h$  are also isomorphic vector spaces.

This shows that  $k[x_1, \dots, x_n]_{\leq s}$  and  $k[x_0, \dots, x_n]_s$  have the same dimension, and the same holds for  $I_{\leq s}$  and  $I_s^h$ . By the dimension formula of Proposition 1, we conclude that

$$(9) \quad \begin{aligned}{}^aHP_I(s) &= \dim k[x_1, \dots, x_n]_{\leq s} / I_{\leq s} \\ &= \dim k[x_0, \dots, x_n]_s / I_s^h = HP_{I^h}(s),\end{aligned}$$

which is what we wanted to prove.

For the second part of (ii), suppose  $V \subset k^n$ . Let  $I = \mathbf{I}_a(V) \subset k[x_1, \dots, x_n]$  and let  $I^h \subset k[x_0, \dots, x_n]$  be the homogenization of  $I$  with respect to  $x_0$ . Then  $\overline{V}$  is defined to be  $\mathbf{V}_p(I^h) \subset \mathbb{P}^n(k)$ . Furthermore, we know from Exercise 8 of Chapter 8, §4 that  $I^h = \mathbf{I}_p(\overline{V})$ . Then

$$\dim V = \deg {}^aHP_I = \deg HP_{I^h} = \dim \overline{V}$$

follows immediately from the first part of (ii), and the theorem is proved. □

Some computer algebra systems can compute Hilbert polynomials. REDUCE has a command to find the affine Hilbert polynomial of an ideal, whereas Macaulay 2 and CoCoA will compute the projective Hilbert polynomial of a homogeneous ideal.

### EXERCISES FOR §3

1. In this exercise, you will verify that if  $V$  is a vector space and  $W$  is a subspace of  $V$ , then  $V/W$  is a vector space.

- a. Show that the relation on  $V$  defined by  $v \sim v'$  if  $v - v' \in W$  is an equivalence relation.
  - b. Show that the addition and scalar multiplication operations on the equivalence classes defined in the text are well-defined. That is, if  $v, v', w, w' \in V$  are such that  $[v] = [v']$  and  $[w] = [w']$ , then show that  $[v + w] = [v' + w']$  and  $[av] = [av']$  for all  $a \in k$ .
  - c. Verify that  $V/W$  is a vector space under the operations given in part b.
2. Let  $V$  be a finite-dimensional vector space and let  $W$  be a vector subspace of  $V$ . If  $\{v_1, \dots, v_m, v_{m+1}, \dots, v_{m+n}\}$  is a basis of  $V$  such that  $\{v_1, \dots, v_m\}$  is a basis for  $W$ , then show that  $[v_{m+1}], \dots, [v_{m+n}]$  are linearly independent in  $V/W$ .
  3. Show that a nonzero ideal  $I \subset k[x_1, \dots, x_n]$  is infinite-dimensional as a vector space over  $k$ . Hint: Pick  $f \neq 0$  in  $I$  and consider  $x^\alpha f$ .
  4. The proofs of Propositions 4 and 9 involve finding vector space bases of  $k[x_1, \dots, x_n]_{\leq s}$  and  $k[x_1, \dots, x_n]_s$  where the elements in the bases have distinct leading terms. We showed that such bases exist, but our proof was nonconstructive. In this exercise, we will illustrate a method for actually finding such a basis. We will only discuss the homogeneous case, but the method applies equally well to the affine case.

The basic idea is to start with any basis of  $I$ , and order the elements according to their leading terms. If two of the basis elements have the same leading monomial, we can replace one of them with a  $k$ -linear combination that has a smaller leading monomial. Continuing in this way, we will get the desired basis.

To see how this works in practice, let  $I$  be a homogeneous ideal in  $k[x, y, z]$ , and suppose that  $\{x^3 - xy^2, x^3 + x^2y - z^3, x^2y - y^3\}$  is a basis for  $I_3$ . We will use grlex order with  $x > y > z$ .

- a. Show that if we subtract the first polynomial from the second, leaving the third polynomial unchanged, then we get a new basis for  $I_3$ .
  - b. The second and third polynomials in this new basis now have the same leading monomial. Show that if we change the third polynomial by subtracting the second polynomial from it and multiplying the result by  $y - 1$ , we end up with a basis  $\{x^3 - xy^2, x^2y + xy^2 - z^3, xy^2 + y^3 - z^3\}$  for  $I_3$  in which all three leading monomials are distinct.
5. Let  $I = \langle x^3 - xyz, y^4 - xyz^2, xy - z^2 \rangle$ . Using grlex order with  $x > y > z$  find bases of  $I_3$  and  $I_4$  where the elements in the bases have distinct leading monomials. Hint: Use the method of Exercise 4.
  6. Use the methods of §2 to compute the affine Hilbert polynomials for each of the following ideals.
    - a.  $I = \langle x^3y, xy^2 \rangle \subset k[x, y]$ .
    - b.  $I = \langle x^3y^2 + 3x^2y^2 + y^3 + 1 \rangle \subset k[x, y]$ .
    - c.  $I = \langle x^3yz^5, xy^3z^2 \rangle \subset k[x, y, z]$ .
    - d.  $I = \langle x^3 - yz^2, y^4 - x^2yz \rangle \subset k[x, y, z]$ .
  7. Find the index of regularity [that is, the smallest  $s_0$  such that  ${}^aHF_I(s) = {}^aHP_I(s)$  for all  $s \geq s_0$ ] for each of the ideals in Exercise 6.
  8. In this exercise, we will show that if  $I_1 \subset I_2$  are ideals in  $k[x_1, \dots, x_n]$ , then

$$\deg {}^aHP_{I_2} \leq \deg {}^aHP_{I_1}.$$

- a. Show that  $I_1 \subset I_2$  implies  $C((LT(I_2))) \subset C((LT(I_1)))$  in  $\mathbb{Z}_{\geq 0}^n$ .
- b. Show that for  $s \geq 0$ , the affine Hilbert functions satisfy the inequality

$${}^aHF_{I_2}(s) \leq {}^aHF_{I_1}(s)$$

- c. From part (b), deduce the desired statement about the degrees of the affine Hilbert polynomials. Hint: Argue by contradiction and consider the values of the polynomials as  $s \rightarrow \infty$ .

- d. If  $I_1 \subset I_2$  are homogeneous ideals in  $k[x_0, \dots, x_n]$ , prove an analogous inequality for the degrees of the Hilbert polynomials of  $I_1$  and  $I_2$ .
9. Use Definition 7 to show that a point  $p = (a_1, \dots, a_n) \in k^n$  gives a variety of dimension zero. Hint: Use Exercise 7 of Chapter 4, §5 to describe  $\mathbf{I}(\{p\})$ .
10. Let  $I \subset k[x_1, \dots, x_n]$  be a monomial ideal, and assume that  $k$  is an infinite field. In this exercise, we will study  $\mathbf{I}(\mathbf{V}(I))$ .
- Show that  $\mathbf{I}(\mathbf{V}(x_{i_1}, \dots, x_{i_r})) = \langle x_{i_1}, \dots, x_{i_r} \rangle$ . Hint: Use Proposition 5 of Chapter 1, §1.
  - Show that an intersection of monomial ideals is a monomial ideal. Hint: Use Lemma 3 of Chapter 2, §4.
  - Show that  $\mathbf{I}(\mathbf{V}(I))$  is a monomial ideal. Hint: Use parts(a) and (b) together with Theorem 15 of Chapter 4, §3.
  - The final step is to show that  $\mathbf{I}(\mathbf{V}(I)) = \sqrt{I}$ . We know that  $\sqrt{I} \subset \mathbf{I}(\mathbf{V}(I))$ , and since  $\mathbf{I}(\mathbf{V}(I))$  is a monomial ideal, you need only prove that  $x^\alpha \in \mathbf{I}(\mathbf{V}(I))$  implies that  $x^{r\alpha} \in I$  for some  $r > 0$ . Hint: If  $I = \langle m_1, \dots, m_t \rangle$  and  $x^{r\alpha} \notin I$  for  $r > 0$ , show that for every  $j$ , there is  $x_{i_j}$  such that  $x_{i_j}$  divides  $m_j$  but not  $x^\alpha$ . Use  $x_{i_1}, \dots, x_{i_t}$  to obtain a contradiction.
  - Let  $\mathbb{F}_2$  be a field with two elements and let  $I = \langle x \rangle \subset \mathbb{F}_2[x, y]$ . Show that  $\mathbf{I}(\mathbf{V}(I)) = \langle x, y^2 - y \rangle$ . This is bigger than  $\sqrt{I}$  and is not a monomial ideal.
11. Let  $I = \langle x^2 + y^2 \rangle \subset \mathbb{R}[x, y]$ .
- Show carefully that  $\deg {}^aHP_I = 1$ .
  - Use Exercise 9 to show that  $\dim \mathbf{V}(I) = 0$ .
12. Compute the dimension of the affine varieties defined by the following ideals. You may assume that  $k$  is algebraically closed.
- $I = \langle xz, xy - 1 \rangle \subset k[x, y, z]$ .
  - $I = \langle zw - y^2, xy - z^3 \rangle \subset k[x, y, z, w]$ .
13. Consider the polynomial ring  $k[x_0, \dots, x_n]$ .
- Given an example to show that the set of polynomials of total degree  $s$  is not closed under addition and, hence, does not form a vector space.
  - Show that the set of homogeneous polynomials of total degree  $s$  (together with the zero polynomial) is a vector space over  $k$ .
  - Use Lemma 5 of §2 to show that this vector space has dimension  $\binom{n+s}{s}$ . Hint: Consider the number of polynomials of total degree  $\leq s$  and  $\leq s - 1$ .
  - Give a second proof of the dimension formula of part (c) using the isomorphism of Exercise 20 below.
14. If  $I$  is a homogeneous ideal, show that the Hilbert polynomials  $HP_I$  and  $HP_{\sqrt{I}}$  have the same degree. Hint: The quickest way is to use Theorem 12.
15. We will study when the Hilbert polynomial is zero.
- If  $I \subset k[x_0, \dots, x_n]$  is a homogeneous ideal, prove that  $\langle x_0, \dots, x_n \rangle^r \subset I$  for some  $r \geq 0$  if and only if the Hilbert polynomial of  $I$  is the zero polynomial.
  - Conclude that if  $V \subset \mathbb{P}^n(k)$  is a variety, then  $V = \emptyset$  if and only if its Hilbert polynomial is the zero polynomial. Thus, the empty variety in  $\mathbb{P}^n(k)$  does not have a dimension.
16. Compute the dimension of the following projective varieties. Assume that  $k$  is algebraically closed.
- $I = \langle x^2 - y^2, x^3 - x^2y + y^3 \rangle \subset k[x, y, z]$ .
  - $I = \langle y^2 - xz, x^2y - z^2w, x^3 - yzw \rangle \subset k[x, y, z, w]$ .
17. In this exercise, we will see that in general, there is no relation between the number of variables  $n$ , the number  $r$  of polynomials in a basis of  $I$ , and the dimension of  $V = \mathbf{V}(I)$ . Let  $V \subset \mathbb{P}^3(k)$  be the curve given by the projective parametrization  $x = t^3u^2, y = t^4u, z = t^5, w = u^5$ . Since this is a curve in 3-dimensional space, our intuition would lead us to believe that  $V$  should be defined by two equations. Assume that  $k$  is algebraically closed.

- a. Use Theorem 12 of Chapter 8, §5 to find an ideal  $I \subset k[x, y, z, w]$  such that  $V = \mathbf{V}(I)$  in  $\mathbb{P}^3(k)$ . If you use grevlex for a certain ordering of the variables, you will get a basis of  $I$  containing three elements.
  - b. Show that  $I_2$  is 1-dimensional and  $I_3$  is 6-dimensional.
  - c. Show that  $I$  cannot be generated by two elements. Hint: Suppose that  $I = \langle A, B \rangle$ , where  $A$  and  $B$  are homogeneous. By considering  $I_2$ , show that  $A$  or  $B$  must be a multiple of  $y^2 - xz$ , and then derive a contradiction by looking at  $I_3$ .
- A much more difficult question would be to prove that there are no two homogeneous polynomials  $A, B$  such that  $V = \mathbf{V}(A, B)$ .
- 18. This exercise is concerned with the proof of part (i) of Theorem 12.
    - a. Use the methods of §2 to show that  $HF_I(s) = {}^aHF_I(s) - {}^aHF_I(s - 1)$  whenever  $I$  is a monomial ideal.
    - b. Prove that  $HF_I(s) = {}^aHF_I(s) - {}^aHF_I(s - 1)$  for an arbitrary homogeneous ideal  $I$ .
  - 19. If  $V \subset \mathbb{P}^n(k)$  is a nonempty projective variety and  $C_V \subset k^{n+1}$  is its affine cone, then prove that  $\mathbf{I}_p(V) = \mathbf{I}_a(C_V)$  in  $k[x_0, \dots, x_n]$ .
  - 20. This exercise is concerned with the proof of part (ii) of Theorem 12.
    - a. Show that the maps  $\phi$  and  $\psi$  defined in (7) are linear maps and verify that they are inverses of each other.
    - b. Prove (8) and conclude that  $\phi : I_{\leq s} \rightarrow I_s^h$  is an isomorphism whose inverse is  $\psi$ .

### §4 Elementary Properties of Dimension

Using the definition of the dimension of a variety from §3, we can now state several basic properties of dimension. As in §3, we assume that the field  $k$  is infinite.

**Proposition 1.** *Let  $V_1$  and  $V_2$  be projective or affine varieties. If  $V_1 \subset V_2$ , then  $\dim V_1 \leq \dim V_2$ .*

**Proof.** We leave the proof to the reader as Exercise 1. □

We next will study the relation between the dimension of a variety and the number of defining equations. We begin with the case where  $V$  is defined by a single equation.

**Proposition 2.** *Let  $k$  be an algebraically closed field and let  $f \in k[x_0, \dots, x_n]$  be a nonconstant homogeneous polynomial. Then the dimension of the projective variety in  $\mathbb{P}^n(k)$  defined by  $f$  is*

$$\dim \mathbf{V}(f) = n - 1.$$

**Proof.** Fix a monomial order  $>$  on  $k[x_0, \dots, x_n]$ . Since  $k$  is algebraically closed, Theorem 11 of §3 says the dimension of  $\mathbf{V}(f)$  is the maximum dimension of a projective coordinate subspace contained in  $\mathbf{V}(\langle \text{LT}(I) \rangle)$ , where  $I = \langle f \rangle$ . One can check that  $\langle \text{LT}(I) \rangle = \langle \text{LT}(f) \rangle$ , and since  $\text{LT}(f)$  is a nonconstant monomial, the projective variety  $\mathbf{V}(\text{LT}(f))$  is a union of subspaces of  $\mathbb{P}^n(k)$  of dimension  $n - 1$ . It follows that  $\dim \mathbf{V}(I) = n - 1$ . □

Thus, when  $k$  is algebraically closed, a hypersurface  $\mathbf{V}(f)$  in  $\mathbb{P}^n$  always has dimension  $n - 1$ . We leave it as an exercise for the reader to prove the analogous statement for affine hypersurfaces.

It is important to note that these results are *not valid* if  $k$  is not algebraically closed. For instance, let  $I = \langle x^2 + y^2 \rangle$  in  $\mathbb{R}[x, y]$ . In §3, we saw that  $\mathbf{V}(f) = \{(0, 0)\} \subset \mathbb{R}^2$  has dimension 0, yet Proposition 2 would predict that the dimension was 1. In fact, over a nonalgebraically closed field, the variety in  $k^n$  or  $\mathbb{P}^n$  defined by a single polynomial can have any dimension between 0 and  $n - 1$ .

The following theorem establishes the analogue of Proposition 2 when the ambient space  $\mathbb{P}^n(k)$  is replaced by an arbitrary variety  $V$ . Note that if  $I$  is an ideal and  $f$  is a polynomial, then  $\mathbf{V}(I + \langle f \rangle) = \mathbf{V}(I) \cap \mathbf{V}(f)$ .

**Theorem 3.** *Let  $k$  be an algebraically closed field and let  $I$  be a homogeneous ideal in  $k[x_0, \dots, x_n]$ . If  $\dim \mathbf{V}(I) > 0$  and  $f$  is any nonconstant homogeneous polynomial, then*

$$\dim \mathbf{V}(I) \geq \dim \mathbf{V}(I + \langle f \rangle) \geq \dim \mathbf{V}(I) - 1$$

**Proof.** To compute the dimension of  $\mathbf{V}(I + \langle f \rangle)$ , we will need to compare the Hilbert polynomials  $HP_I$  and  $HP_{I+\langle f \rangle}$ . We first note that since  $I \subset I + \langle f \rangle$ , Exercise 8 of §3 implies that

$$\deg HP_I \geq \deg HP_{I+\langle f \rangle},$$

from which we conclude that  $\dim \mathbf{V}(I) \geq \dim \mathbf{V}(I + \langle f \rangle)$  by Theorem 11 of §3.

To obtain the other inequality, suppose that  $f$  has total degree  $r > 0$ . Fix a total degree  $s \geq r$  and consider the map

$$\pi : k[x_0, \dots, x_n]_s / I_s \longrightarrow k[x_0, \dots, x_n]_s / (I + \langle f \rangle)_s$$

which sends  $[g] \in k[x_0, \dots, x_n]_s / I_s$  to  $\pi([g]) = [g] \in k[x_0, \dots, x_n]_s / (I + \langle f \rangle)_s$ . In Exercise 4, you will check that  $\pi$  is a well-defined linear map. It is easy to see that  $\pi$  is onto, and to investigate its kernel, we will use the map

$$\alpha_f : k[x_0, \dots, x_n]_{s-r} / I_{s-r} \longrightarrow k[x_0, \dots, x_n]_s / I_s$$

defined by sending  $[h] \in k[x_0, \dots, x_n]_{s-r} / I_{s-r}$  to  $\alpha_f([h]) = [fh] \in k[x_0, \dots, x_n]_s / I_s$ . In Exercise 5, you will show that  $\alpha_f$  is also a well-defined linear map.

We claim that the kernel of  $\pi$  is exactly the image of  $\alpha_f$ , i.e., that

$$(1) \quad \alpha_f(k[x_0, \dots, x_n]_{s-r} / I_{s-r}) = \{[g] : \pi([g]) = [0] \text{ in } k[x_0, \dots, x_n]_s / (I + \langle f \rangle)_s\}.$$

To prove this, note that if  $h \in k[x_0, \dots, x_n]_{s-r}$ , then  $fh \in (I + \langle f \rangle)_s$  and, hence,  $\pi([fh]) = [0]$  in  $k[x_0, \dots, x_n]_s / (I + \langle f \rangle)_s$ . Conversely, if  $g \in k[x_0, \dots, x_n]_s$  and  $\pi([g]) = [0]$ , then  $g \in (I + \langle f \rangle)_s$ . This means  $g = g' + fh$  for some  $g' \in I$ . If we write  $g' = \sum_i g'_i$  and  $h = \sum_i h_i$  as sums of homogeneous polynomials, where  $g'_i$  and  $h_i$  have total degree  $i$ , it follows that  $g = g'_s + fh_{s-r}$  since  $g$  and  $f$  are homogeneous. Since  $I$  is a homogeneous ideal, we have  $g'_s \in I_s$ , and it follows that  $[g] = [fh_{s-r}] = \alpha_f([h_{s-r}])$  in  $k[x_0, \dots, x_n]_s / I_s$ . This shows that  $[g]$  is in the image of  $\alpha_f$  and completes the proof of (1).

Since  $\pi$  is onto and we know its kernel by (1), the dimension theorem for linear mappings shows that

$$\dim k[x_0, \dots, x_n]_s / I_s = \dim \alpha_f(k[x_0, \dots, x_n]_{s-r} / I_{s-r}) + \dim(k[x_0, \dots, x_n]_s / I + \langle f \rangle)_s.$$

Now certainly,

$$(2) \quad \dim \alpha_f(k[x_0, \dots, x_n]_{s-r} / I_{s-r}) \leq \dim k[x_0, \dots, x_n]_{s-r} / I_{s-r},$$

with equality if and only if  $\alpha_f$  is one-to-one. Hence,

$$\dim k[x_0, \dots, x_n]_s / (I + \langle f \rangle)_s \geq \dim k[x_0, \dots, x_n]_s / I_s - \dim k[x_0, \dots, x_n]_{s-r} / I_{s-r}.$$

In terms of Hilbert functions, this tells us that

$$HF_{I+\langle f \rangle}(s) \geq HF_I(s) - HF_I(s-r)$$

whenever  $s \geq r$ . Thus, if  $s$  is sufficiently large, we obtain the inequality

$$(3) \quad HP_{I+\langle f \rangle}(s) \geq HP_I(s) - HP_I(s-r)$$

for the Hilbert polynomials.

Suppose that  $HP_I$  has degree  $d$ . Then it is easy to see that the polynomial on the right-hand side of (3) has degree  $d - 1$  (the argument is the same as used in Exercise 15 of §2). Thus, (3) shows that  $HP_{I+\langle f \rangle}(s)$  is  $\geq$  a polynomial of degree  $d - 1$  for  $s$  sufficiently large, which implies  $\deg HP_{I+\langle f \rangle}(s) \geq d - 1$  [see, for example, part (c) of Exercise 8 of §3]. Since  $k$  is algebraically closed, we conclude that  $\dim \mathbf{V}(I + \langle f \rangle) \geq \dim \mathbf{V}(I) - 1$  by Theorem 11 of §3.  $\square$

By carefully analyzing the proof of Theorem 3, we can give a condition that ensures that  $\dim \mathbf{V}(I + \langle f \rangle) = \dim \mathbf{V}(I) - 1$ .

**Corollary 4.** *Let  $k$  be an algebraically closed field and let  $I \subset k[x_0, \dots, x_n]$  be a homogeneous ideal. Let  $f$  be a nonconstant homogeneous polynomial whose class in the quotient ring  $k[x_0, \dots, x_n]/I$  is not a zero divisor. Then*

$$\dim \mathbf{V}(I + \langle f \rangle) = \dim \mathbf{V}(I) - 1$$

when  $\dim \mathbf{V}(I) > 0$ , and  $\mathbf{V}(I + \langle f \rangle) = \emptyset$  when  $\dim \mathbf{V}(I) = 0$ .

**Proof.** As we observed in the proof of Theorem 3, the inequality (2) is an equality if the multiplication map  $\alpha_f$  is one-to-one. We claim that the latter is true if  $[f] \in k[x_0, \dots, x_n]/I$  is not a zero divisor. Namely, suppose that  $[h] \in k[x_0, \dots, x_n]_{s-r} / I_{s-r}$  is nonzero. This implies that  $h \notin I_{s-r}$  and, hence,  $h \notin I$  since  $I_{s-r} = I \cap k[x_0, \dots, x_n]_{s-r}$ . Thus,  $[h] \in k[x_0, \dots, x_n]/I$  is nonzero, so that  $[f][h] = [fh]$  is nonzero in  $k[x_0, \dots, x_n]/I$  by our assumption on  $f$ . Thus,  $fh \notin I$  and, hence,  $\alpha_f([h]) = [fh]$  is nonzero in  $k[x_0, \dots, x_n]_s / I_s$ . This shows that  $\alpha_f$  is one-to-one.

Since (2) is an equality, the proof of Theorem 3 shows that we also get the equality  $\dim(k[x_0, \dots, x_n]_s / (I + \langle f \rangle)_s) = \dim k[x_0, \dots, x_n]_s / I_s - \dim k[x_0, \dots, x_n]_{s-r} / I_{s-r}$  when  $s \geq r$ . In terms of Hilbert polynomials, this says  $HP_{I+\langle f \rangle}(s) = HP_I(s) - HP_I(s-r)$ , and it follows immediately that  $\dim \mathbf{V}(I + \langle f \rangle) = \dim \mathbf{V}(I) - 1$ .  $\square$

We remark that Theorem 3 can fail for affine varieties, even when  $k$  is algebraically closed. For example, consider the ideal  $I = \langle xz, yz \rangle \subset \mathbb{C}[x, y, z]$ . One easily sees that in  $\mathbb{C}^3$ , we have  $\mathbf{V}(I) = \mathbf{V}(z) \cup V(x, y)$ , so that  $\mathbf{V}(I)$  is the union of the  $(x, y)$ -plane and the  $z$ -axis. In particular,  $\mathbf{V}(I)$  has dimension 2 (do you see why?). Now, let  $f = z - 1 \in \mathbb{C}[x, y, z]$ . Then  $\mathbf{V}(f)$  is the plane  $z = 1$  and it follows that  $\mathbf{V}(I + \langle f \rangle) = \mathbf{V}(I) \cap \mathbf{V}(f)$  consists of the single point  $(0, 0, 1)$  (you will check this carefully in Exercise 7). By Exercise 9 of §3, we know that a point has dimension 0. Yet Theorem 3 would predict that  $\mathbf{V}(I + \langle f \rangle)$  had dimension at least 1.

What goes “wrong” here is that the planes  $z = 0$  and  $z = 1$  are parallel and, hence, do not meet in affine space. We are missing a component of dimension 1 at infinity. This is an example of the way dimension theory works more satisfactorily for homogeneous ideals and projective varieties. It is possible to formulate a version of Theorem 3 that is valid for affine varieties, but we will not pursue that question here.

Our next result extends Theorem 3 to the case of several polynomials  $f_1, \dots, f_r$ .

**Proposition 5.** *Let  $k$  be an algebraically closed field and let  $I$  be a homogeneous ideal in  $k[x_0, \dots, x_n]$ . Let  $f_1, \dots, f_r$  be nonconstant homogeneous polynomials in  $k[x_0, \dots, x_n]$  such that  $r \leq \dim \mathbf{V}(I)$ . Then*

$$\dim \mathbf{V}(I + \langle f_1, \dots, f_r \rangle) \geq \dim \mathbf{V}(I) - r.$$

**Proof.** The result follows immediately from Theorem 3 by induction on  $r$ . □

In the exercises, we will ask you to derive a condition on the polynomials  $f_1, \dots, f_r$  which guarantees that the dimension of  $\mathbf{V}(f_1, \dots, f_r)$  is exactly equal to  $n - r$ .

Our next result concerns varieties of dimension 0.

**Proposition 6.** *Let  $V$  be a nonempty affine or projective variety. Then  $V$  consists of finitely many points if and only if  $\dim V = 0$ .*

**Proof.** We will give the proof only in the affine case. Let  $>$  be a graded order on  $k[x_1, \dots, x_n]$ . If  $V$  is finite, then let  $a_j$ , for  $j = 1, \dots, m_i$ , be the distinct elements of  $k$  appearing as  $i$ -th coordinates of points of  $V$ . Then

$$f = \prod_{j=1}^{m_i} (x_i - a_j) \in \mathbf{I}(V)$$

and we conclude that  $\text{LT}(f) = x_i^{m_i} \in \langle \text{LT}(\mathbf{I}(V)) \rangle$ . This implies that  $\mathbf{V}(\langle \text{LT}(\mathbf{I}(V)) \rangle) = \{0\}$  and then Theorem 8 of §3 implies that  $\dim V = 0$ .

Now suppose that  $\dim V = 0$ . Then the affine Hilbert polynomial of  $\mathbf{I}(V)$  is a constant  $C$ , so that

$$\dim k[x_1, \dots, x_n]_{\leq s} / \mathbf{I}(V)_{\leq s} = C$$

for  $s$  sufficiently large. If we also have  $s \geq C$ , then the classes  $[1], [x_i], [x_i^2], \dots, [x_i^s] \in k[x_1, \dots, x_n]_{\leq s} / \mathbf{I}(V)_{\leq s}$  are  $s + 1$  vectors in a vector space of dimension  $C \leq s$  and,



hence, they must be linearly dependent. But a nontrivial linear relation

$$[0] = \sum_{j=0}^s a_j [x_i^j] = \left[ \sum_{j=0}^s a_j x_i^j \right]$$

means that  $\sum_{j=0}^s a_j x_i^j$  is a nonzero polynomial in  $\mathbf{I}(V)_{\leq s}$ . This polynomial vanishes on  $V$ , which implies that there are only finitely many distinct  $i$ -th coordinates among the points of  $V$ . Since this is true for all  $1 \leq i \leq n$ , it follows that  $V$  must be finite.  $\square$

If, in addition,  $k$  is algebraically closed, then we see that the six conditions of Theorem 6 of Chapter 5, §3 are equivalent to  $\dim V = 0$ . In particular, given any defining ideal  $I$  of  $V$ , we get a simple criterion for detecting when a variety has dimension 0.

Now that we understand varieties of dimension 0, let us record some interesting properties of positive dimensional varieties.

**Proposition 7.** *Let  $k$  be algebraically closed.*

- (i) *Let  $V \subset \mathbb{P}^n(k)$  be a projective variety of dimension  $> 0$ . Then  $V \cap \mathbf{V}(f) \neq \emptyset$  for every nonconstant homogeneous polynomial  $f \in k[x_0, \dots, x_n]$ . Thus, a positive dimensional projective variety meets every hypersurface in  $\mathbb{P}^n(k)$ .*
- (ii) *Let  $W \subset k^n$  be an affine variety of dimension  $> 0$ . If  $\overline{W}$  is the projective closure of  $W$  in  $\mathbb{P}^n(k)$ , then  $W \neq \overline{W}$ . Thus, a positive dimensional affine variety always has points at infinity.*

**Proof.** (i) Let  $V = \mathbf{V}(I)$ . Since  $\dim V > 0$ , Theorem 3 shows that  $\dim V \cap \mathbf{V}(f) \geq \dim V - 1 \geq 0$ . Let us check carefully that this guarantees  $V \cap \mathbf{V}(f) \neq \emptyset$ .

If  $V \cap \mathbf{V}(f) = \emptyset$ , then the projective Nullstellensatz implies that  $\langle x_0, \dots, x_n \rangle^r \subset I + \langle f \rangle$  for some  $r \geq 0$ . By Exercise 15 of §3, it follows that  $HP_{I+\langle f \rangle}$  is the zero polynomial. Yet if you examine the proof of Theorem 3, the inequality given for  $HP_{I+\langle f \rangle}$  shows that this polynomial cannot be zero when  $\dim V > 0$ . We leave the details as an exercise.

(ii) The points at infinity of  $W$  are  $\overline{W} \cap \mathbf{V}(x_0)$ , where  $\mathbf{V}(x_0)$  is the hyperplane at infinity. By Theorem 12 of §3, we have  $\dim \overline{W} = \dim W > 0$ , and then (i) implies that  $\overline{W} \cap \mathbf{V}(x_0) \neq \emptyset$ .  $\square$

We next study the dimension of the union of two varieties.

**Proposition 8.** *If  $V$  and  $W$  are varieties either both in  $k^n$  or both in  $\mathbb{P}^n(k)$ , then*

$$\dim(V \cup W) = \max(\dim V, \dim W).$$

**Proof.** The proofs for the affine and projective cases are nearly identical, so we will give only the affine proof.

Let  $I = \mathbf{I}(V)$  and  $J = \mathbf{I}(W)$ , so that  $\dim V = \deg {}^aHP_I$  and  $\dim W = \deg {}^aHP_J$ . It is easy to show that,  $\mathbf{I}(V \cup W) = \mathbf{I}(V) \cap \mathbf{I}(W) = I \cap J$ . It is more convenient to work

with the product ideal  $IJ$  and we note that

$$IJ \subset I \cap J \subset \sqrt{IJ}$$

(see Exercise 15). By Exercise 8 of §3, we conclude that

$$\deg {}^aHP_{\sqrt{IJ}} \leq \deg {}^aHP_{I \cap J} \leq \deg {}^aHP_{IJ}.$$

Proposition 6 of §3 says that the outer terms are equal. We conclude that  $\dim(V \cup W) = \deg {}^aHP_{IJ}$ .

Now fix a graded order  $>$  on  $k[x_1, \dots, x_n]$ . By Propositions 3 and 4 of §3, it follows that  $\dim V$ ,  $\dim W$ , and  $\dim(V \cup W)$  are given by the maximal dimension of a coordinate subspace contained in  $\mathbf{V}(\langle \text{LT}(I) \rangle)$ ,  $\mathbf{V}(\langle \text{LT}(J) \rangle)$  and  $\mathbf{V}(\langle \text{LT}(IJ) \rangle)$  respectively. In Exercise 16, you will prove that

$$\langle \text{LT}(IJ) \rangle \supset \langle \text{LT}(I) \rangle \cdot \langle \text{LT}(J) \rangle.$$

This implies

$$\mathbf{V}(\langle \text{LT}(IJ) \rangle) \subset \mathbf{V}(\langle \text{LT}(I) \rangle) \cup \mathbf{V}(\langle \text{LT}(J) \rangle).$$

Since  $k$  is infinite, every coordinate subspace is irreducible (see Exercise 7 of §1), and as a result, a coordinate subspace contained in  $\mathbf{V}(\langle \text{LT}(IJ) \rangle)$  lies in either  $\mathbf{V}(\langle \text{LT}(I) \rangle)$  or  $\mathbf{V}(\langle \text{LT}(J) \rangle)$ . This implies  $\dim(V \cup W) \leq \max(\dim V, \dim W)$ . The opposite inequality follows from Proposition 1, and the proposition is proved.  $\square$

This proposition has the following useful corollary.

**Corollary 9.** *The dimension of a variety is the largest of the dimensions of its irreducible components.*

**Proof.** If  $V = V_1 \cup \dots \cup V_r$  is the decomposition of  $V$  into irreducible components, then Proposition 8 and an induction on  $r$  shows that

$$\dim V = \max\{\dim V_1, \dots, \dim V_r\},$$

as claimed.  $\square$

This corollary allows us to reduce to the case of an irreducible variety when computing dimensions. The following result shows that for irreducible varieties, the notion of dimension is especially well-behaved.

**Proposition 10.** *Let  $k$  be an algebraically closed field and let  $V \subset \mathbb{P}^n(k)$  be an irreducible variety.*

- (i) *If  $f \in k[x_0, \dots, x_n]$  is a homogeneous polynomial which does not vanish identically on  $V$ , then  $\dim(V \cap \mathbf{V}(f)) = \dim V - 1$  when  $\dim V > 0$ , and  $V \cap \mathbf{V}(f) = \emptyset$  when  $\dim V = 0$ .*
- (ii) *If  $W \subset V$  is a variety such that  $W \neq V$ , then  $\dim W < \dim V$ .*

**Proof.** (i) By Proposition 4 of Chapter 5, §1, we know that  $\mathbf{I}(V)$  is a prime ideal and  $k[V] \cong k[x_0, \dots, x_n]/\mathbf{I}(V)$  is an integral domain. Since  $f \notin \mathbf{I}(V)$ , the class of  $f$  is

nonzero in  $k[x_0, \dots, x_n]/\mathbf{I}(V)$  and, hence, is not a zero divisor. The desired conclusion then follows from Corollary 4.

(ii) If  $W$  is a proper subvariety of  $V$ , then we can find  $f \in \mathbf{I}(W) - \mathbf{I}(V)$ . Thus,  $W \subset V \cap \mathbf{V}(f)$ , and it follows from (i) and Proposition 1 that

$$\dim W \leq \dim(V \cap \mathbf{V}(f)) = \dim V - 1 < \dim V.$$

This completes the proof of the proposition. □

Part (i) of Proposition 10 asserts that when  $V$  is irreducible and  $f$  does not vanish on  $V$ , then some component of  $V \cap \mathbf{V}(f)$  has dimension  $\dim V - 1$ . With some more work, it can be shown that *every* component of  $V \cap \mathbf{V}(f)$  has dimension  $\dim V - 1$ . See, for example, Theorem 3.8 in Chapter IV of KENDIG (1977) or Theorem 5 of Chapter 1, §6 of SHAFAREVICH (1974).

In the next section, we will see that there is a way to understand the meaning of the dimension of an *irreducible* variety  $V$  in terms of the coordinate ring  $k[V]$  and the field of rational functions  $k(V)$  of  $V$  that we introduced in Chapter 5.

**EXERCISES FOR §4**

1. Prove Proposition 1. Hint: Use Exercise 8 of the previous section.
2. Let  $k$  be an algebraically closed field. If  $f \in k[x_1, \dots, x_n]$  is a nonconstant polynomial, show that the affine hypersurface  $\mathbf{V}(f) \subset k^n$  has dimension  $n - 1$ .
3. In  $\mathbb{R}^4$ , give examples of four different affine varieties, each defined by a single equation, that have dimensions 0, 1, 2, 3, respectively.
4. In this exercise, we study the mapping

$$\pi : k[x_0, \dots, x_n]_s / I_s \longrightarrow k[x_0, \dots, x_n]_s / (I + \langle f \rangle)_s$$

defined by  $\pi([g]) = [g]$  for all  $g \in k[x_0, \dots, x_n]_s$ .

- a. Show that  $\pi$  is well-defined. That is, show that the image of the class  $[g]$  does not depend on which representative  $g$  in the class that we choose. We call  $\pi$  the *natural projection* from  $k[x_0, \dots, x_n]_s / I_s$  to  $k[x_0, \dots, x_n]_s / (I + \langle f \rangle)_s$ .
- b. Show that  $\pi$  is a linear mapping of vector spaces.
- c. Show that the natural projection  $\pi$  is onto.
5. Show that if  $f$  is a homogeneous polynomial of degree  $r$  and  $I$  is a homogeneous ideal, then the map

$$\alpha_f : k[x_0, \dots, x_n]_{s-r} / I_{s-r} \longrightarrow k[x_0, \dots, x_n]_s / I_s$$

defined by  $\alpha_f([h]) = [f \cdot h]$  is a well-defined linear mapping. That is, show that  $\alpha_f([h])$  does not depend on the representative  $h$  for the class and that  $\alpha_f$  preserves the vector space operations.

6. Let  $f \in k[x_0, \dots, x_n]$  be a homogeneous polynomial of total degree  $r > 0$ .
  - a. Find a formula for the Hilbert polynomial of  $\langle f \rangle$ . Your formula should depend only on  $n$  and  $r$  (and, of course,  $s$ ). In particular, all such polynomials  $f$  have the same Hilbert polynomial. Hint: Examine the proofs of Theorem 3 and Corollary 4 in the case when  $I = \{0\}$ .

- b. More generally, suppose that  $V = \mathbf{V}(I)$  and that the class of  $f$  is not a zero divisor in  $k[x_0, \dots, x_n]/I$ . Then show that the Hilbert polynomial of  $I + \langle f \rangle$  depends only on  $I$  and  $r$ .

If we vary  $f$ , we can regard the varieties  $\mathbf{V}(f) \subset \mathbb{P}^n(k)$  as an algebraic family of hypersurfaces. Similarly, varying  $f$  gives the family of varieties  $V \cap \mathbf{V}(f)$ . By parts (a) and (b), the Hilbert polynomials are constant as we vary  $f$ . In general, once a technical condition called “flatness” is satisfied, Hilbert polynomials are constant on any algebraic families of varieties.

7. Let  $I = \langle xz, yz \rangle$ . Show that  $\mathbf{V}(I + \langle z - 1 \rangle) = \{(0, 0, 1)\}$ .
8. Let  $R = k[x_0, \dots, x_n]$ . A sequence  $f_1, \dots, f_r$  of  $r \leq n + 1$  nonconstant homogeneous polynomials is called an  $R$ -sequence if the class  $[f_{j+1}]$  is not a zero divisor in  $R/\langle f_1, \dots, f_j \rangle$  for each  $1 \leq j < r$ .
- a. Show for example that for  $r \leq n$ ,  $x_0, \dots, x_r$  is an  $R$ -sequence.
- b. Show that if  $k$  is algebraically closed and  $f_1, \dots, f_r$  is an  $R$ -sequence, then
- $$\dim \mathbf{V}(f_1, \dots, f_r) = n - r.$$
- Hint: Use Corollary 4 and induction on  $r$ . Work with the ideals  $I_j = \langle f_1, \dots, f_j \rangle$  for  $1 \leq j \leq r$ .
9. Let  $R = k[x_0, \dots, x_n]$  be the polynomial ring. A homogeneous ideal  $I$  is said to be a *complete intersection* if it can be generated by an  $R$ -sequence. A projective variety  $V$  is called a *complete intersection* if  $\mathbf{I}(V)$  is a complete intersection.
- a. Show that every irreducible linear subspace of  $\mathbb{P}^n(k)$  is a complete intersection.
- b. Show that hypersurfaces are complete intersections when  $k$  is algebraically closed.
- c. Show that projective closure of the union of the  $(x, y)$ - and  $(z, w)$ -planes in  $k^4$  is not a complete intersection.
- d. Let  $V$  be the affine twisted cubic  $\mathbf{V}(y - x^2, z - x^3)$  in  $k^3$ . Is the projective closure of  $V$  a complete intersection?

Hint for parts (c) and (d): Use the technique of Exercise 17 of §3.

10. Suppose that  $I \subset k[x_1, \dots, x_n]$  is an ideal. In this exercise, we will prove that the affine Hilbert polynomial is constant if and only if the quotient ring  $k[x_1, \dots, x_n]/I$  is finite-dimensional as a vector space over  $k$ . Furthermore, when this happens, we will show that the constant is the dimension of  $k[x_1, \dots, x_n]/I$  as a vector space over  $k$ .
- a. Let  $\alpha_s : k[x_1, \dots, x_n]_{\leq s}/I_{\leq s} \rightarrow k[x_1, \dots, x_n]/I$  be the map defined by  $\alpha_s([f]) = [f]$ . Show that  $\alpha_s$  is well-defined and one-to-one.
- b. If  $k[x_1, \dots, x_n]/I$  is finite-dimensional, show that  $\alpha_s$  is an isomorphism for  $s$  sufficiently large and conclude that the affine Hilbert polynomial is constant (and equals the dimension of  $k[x_1, \dots, x_n]/I$ ). Hint: Pick a basis  $[f_1], \dots, [f_m]$  of  $k[x_1, \dots, x_n]/I$  and let  $s$  be bigger than the total degrees of  $f_1, \dots, f_m$ .
- c. Now suppose the affine Hilbert polynomial is constant. Show that if  $s \leq t$ , the image of  $\alpha_t$  contains the image of  $\alpha_s$ . If  $s$  and  $t$  are large enough, conclude that the images are equal. Use this to show that  $\alpha_s$  is an isomorphism for  $s$  sufficiently large and conclude that  $k[x_1, \dots, x_n]/I$  is finite-dimensional.
11. Let  $V \subset k^n$  be finite. In this exercise, we will prove that  $k[x_1, \dots, x_n]/\mathbf{I}(V)$  is finite-dimensional and that its dimension is  $|V|$ , the number of points in  $V$ . If we combine this with the previous exercise, we see that the affine Hilbert polynomial of  $\mathbf{I}(V)$  is the constant  $|V|$ . Suppose that  $V = \{p_1, \dots, p_m\}$ , where  $m = |V|$ .
- a. Define a map  $\phi : k[x_1, \dots, x_n]/\mathbf{I}(V) \rightarrow k^m$  by  $\phi([f]) = (f(p_1), \dots, f(p_m))$ . Show that  $\phi$  is a well-defined linear map and show that it is one-to-one.
- b. Fix  $i$  and let  $W_i = \{p_j : j \neq i\}$ . Show that  $1 \in \mathbf{I}(W_i) + \mathbf{I}(\{p_i\})$ . Hint: Show that  $\mathbf{I}(\{p_i\})$  is a maximal ideal.

- c. By part (b), we can find  $f_i \in \mathbf{I}(W_i)$  and  $g_i \in \mathbf{I}(\{p_i\})$  such that  $f_i + g_i = 1$ . Show that  $\phi(f_i)$  is the vector in  $k^m$  which has a 1 in the  $i$ -th coordinate and 0's elsewhere.
  - d. Conclude that  $\phi$  is an isomorphism and that  $\dim k[x_1, \dots, x_n]/\mathbf{I}(V) = |V|$ .
12. Let  $I \subset k[x_0, \dots, x_n]$  be a homogeneous ideal. In this exercise we will study the geometric significance of the coefficient  $b_0$  of the Hilbert polynomial

$$HP_I(s) = \sum_{i=0}^d b_i \binom{s}{d-i}.$$

We will call  $b_0$  the *degree* of  $I$ . The *degree* of a projective variety  $V$  is defined to be the degree of  $\mathbf{I}(V)$  and, as we will see, the degree is in a sense a generalization of the total degree of the defining equation for a hypersurface. Note also that we can regard Exercises 10 and 11 as studying the degrees of ideals and varieties with constant affine Hilbert polynomial.

- a. Show that the degree of the ideal  $\langle f \rangle$  is the same as the total degree of  $f$ . Also, if  $k$  is algebraically closed, show that the degree of the hypersurface  $\mathbf{V}(f)$  is the same as the total degree of  $f_{red}$ , the reduction of  $f$  defined in Chapter 4, §2. Hint: Use Exercise 6.
- b. Show that if  $I$  is a complete intersection (Exercise 9) generated by the elements of an  $R$ -sequence  $f_1, \dots, f_r$ , then the degree of  $I$  is the product

$$\deg f_1 \cdot \deg f_2 \cdots \deg f_r,$$

of the total degrees of the  $f_i$ . Hint: Look carefully at the proof of Theorem 3. The hint for Exercise 8 may be useful.

- c. Determine the degree of the projective closure of the standard twisted cubic.
13. Verify carefully the claim made in the proof of Proposition 7 that  $HP_{I+\langle f \rangle}$  cannot be the zero polynomial when  $\dim V > 0$ . Hint: Look at the inequality (3) from the proof of Theorem 3.
14. This exercise will explore what happens if we weaken the hypotheses of Proposition 7.
- a. Let  $V = \mathbf{V}(x) \subset k^2$ . Show that  $V \cap \mathbf{V}(x-1) = \emptyset$  and explain why this does not contradict part (a) of the proposition.
  - b. Let  $W = \mathbf{V}(x^2 + y^2 - 1) \subset \mathbb{R}^2$ . Show that  $W = \overline{W}$  in  $\mathbb{P}^2(\mathbb{R})$  and explain why this does not contradict part (b) of the proposition.
15. If  $I, J \subset k[x_1, \dots, x_n]$  are ideals, prove that  $IJ \subset I \cap J \subset \sqrt{IJ}$ .
16. Show that if  $I$  and  $J$  are any ideals and  $>$  is any monomial ordering, then

$$\langle \text{LT}(I) \rangle \cdot \langle \text{LT}(J) \rangle \subset \langle \text{LT}(IJ) \rangle.$$

17. Using Proposition 10, we can get an alternative definition of the dimension of an irreducible variety. We will assume that the field  $k$  is algebraically closed and that  $V \subset \mathbb{P}^n(k)$  is irreducible.
- a. If  $\dim V > 0$ , prove that there is an irreducible variety  $W \subset V$  such that  $\dim W = \dim V - 1$ . Hint: Use Proposition 10 and look at the irreducible components of  $V \cap \mathbf{V}(f)$ .
  - b. If  $\dim V = m$ , prove that one can find a chain of  $m + 1$  irreducible varieties

$$V_0 \subset V_1 \subset \cdots \subset V_m = V$$

such that  $V_i \not\subset V_{i+1}$  for  $0 \leq i \leq m - 1$ .

- c. Show that it is impossible to find a similar chain of length greater than  $m + 1$  and conclude that the dimension of an irreducible variety is one less than the length of the longest strictly increasing chain of irreducible varieties contained in  $V$ .
18. Prove an affine version of part (ii) of Proposition 10.

## §5 Dimension and Algebraic Independence

In §3, we defined the dimension of an affine variety as the degree of the affine Hilbert polynomial. This was useful for proving the properties of dimension in §4, but Hilbert polynomials do not give the full story. In algebraic geometry, there are many ways to formulate the concept of dimension and we will explore two of the more interesting approaches in this section and the next.

If  $V \subset k^n$  is an affine variety, recall from Chapter 5 that the *coordinate ring*  $k[V]$  consists of all polynomial functions on  $V$ . This is related to the ideal  $\mathbf{I}(V)$  by the natural ring isomorphism  $k[V] \cong k[x_1, \dots, x_n]/\mathbf{I}(V)$  (which is the identity on  $k$ ) discussed in Theorem 7 of Chapter 5, §2. To see what  $k[V]$  has to do with dimension, note that for any  $s \geq 0$ , there is a well-defined linear map

$$(1) \quad k[x_1, \dots, x_n]_{\leq s}/\mathbf{I}(V)_{\leq s} \longrightarrow k[x_1, \dots, x_n]/\mathbf{I}(V) \cong k[V]$$

which is one-to-one (see Exercise 10 of §4). Thus, we can regard  $k[x_1, \dots, x_n]_{\leq s}/\mathbf{I}(V)_{\leq s}$  as a finite-dimensional “piece” of  $k[V]$  that approximates  $k[V]$  more and more closely as  $s$  gets larger. Since the degree of  ${}^aHP_{\mathbf{I}(V)}$  measures how fast these finite-dimensional approximations are growing, we see that  $\dim V$  tells us something about the “size” of  $k[V]$ .

This discussion suggests that we should be able to formulate the dimension of  $V$  directly in terms of the ring  $k[V]$ . To do this, we will use the notion of algebraically independent elements.

**Definition 1.** We say that elements  $\phi_1, \dots, \phi_r \in k[V]$  are **algebraically independent over  $k$**  if there is no nonzero polynomial  $p$  of  $r$  variables with coefficients in  $k$  such that  $p(\phi_1, \dots, \phi_r) = 0$  in  $k[V]$ .

Note that if  $\phi_1, \dots, \phi_r \in k[V]$  are algebraically independent over  $k$ , then the  $\phi_i$ 's are distinct and nonzero. It is also easy to see that any subset of  $\{\phi_1, \dots, \phi_r\}$  is also algebraically independent over  $k$  (see Exercise 1 for the details).

The simplest example of algebraically independent elements occurs when  $V = k^n$ . If  $k$  is an infinite field, we have  $\mathbf{I}(V) = \{0\}$  and, hence,  $k[V] = k[x_1, \dots, x_n]$ . Here, the elements  $x_1, \dots, x_n$  are algebraically independent over  $k$  since  $p(x_1, \dots, x_n) = 0$  means that  $p$  is the zero polynomial.

For another example, let  $V$  be the twisted cubic in  $\mathbb{R}^3$ , so that  $\mathbf{I}(V) = \langle y - x^2, z - x^3 \rangle$ . Let us show that  $[x] \in \mathbb{R}[V]$  is algebraically independent over  $\mathbb{R}$ . Suppose  $p$  is a polynomial with coefficients in  $\mathbb{R}$  such that  $p([x]) = [0]$  in  $\mathbb{R}[V]$ . By the way we defined the ring operations in  $\mathbb{R}[V]$ , this means  $[p(x)] = [0]$ , so that  $p(x) \in \mathbf{I}(V)$ . But it is easy to show that  $\mathbb{R}[x] \cap \langle y - x^2, z - x^3 \rangle = \{0\}$ , which proves that  $p$  is the zero polynomial. On the other hand, we leave it to the reader to verify that  $[x], [y] \in \mathbb{R}[V]$  are not algebraically independent over  $\mathbb{R}$  since  $[y] - [x]^2 = [0]$  in  $\mathbb{R}[V]$ .

We can relate the dimension of  $V$  to the number of algebraically independent elements in the coordinate ring  $k[V]$  as follows.

**Theorem 2.** *Let  $V \subset k^n$  be an affine variety. Then the dimension of  $V$  equals the maximal number of elements of  $k[V]$  which are algebraically independent over  $k$ .*

**Proof.** We will first show that if  $d = \dim V$ , then we can find  $d$  elements of  $k[V]$  which are algebraically independent over  $k$ . To do this, let  $I = \mathbf{I}(V)$  and consider the ideal of leading terms  $\langle \text{LT}(I) \rangle$  for some graded order on  $k[x_1, \dots, x_n]$ . By Theorem 8 of §3, we know that  $d$  is the maximum dimension of a coordinate subspace contained in  $\mathbf{V}(\langle \text{LT}(I) \rangle)$ . A coordinate subspace  $W \subset \mathbf{V}(\langle \text{LT}(I) \rangle)$  of dimension  $d$  is defined by the vanishing of  $n - d$  coordinates, so that we can write  $W = \mathbf{V}(x_j : j \notin \{i_1, \dots, i_d\})$  for some  $1 \leq i_1 < \dots < i_d \leq n$ . We will show that  $[x_{i_1}], \dots, [x_{i_d}] \in k[V]$  are algebraically independent over  $k$ .

If we let  $p \in k^n$  be the point whose  $i_j$ -th coordinate is 1 for  $1 \leq j \leq d$  and whose other coordinates are 0, then  $p \in W \subset \mathbf{V}(\langle \text{LT}(I) \rangle)$ . Then every monomial in  $\langle \text{LT}(I) \rangle$  vanishes at  $p$  and, hence, no monomial in  $\langle \text{LT}(I) \rangle$  can involve only  $x_{i_1}, \dots, x_{i_d}$  (this is closely related to the proof of Proposition 2 of §2). Since  $\langle \text{LT}(I) \rangle$  is a monomial ideal, this implies that  $\langle \text{LT}(I) \rangle \cap k[x_{i_1}, \dots, x_{i_d}] = \{0\}$ . Then

$$(2) \quad I \cap k[x_{i_1}, \dots, x_{i_d}] = \{0\}$$

since a nonzero element  $f \in I \cap k[x_{i_1}, \dots, x_{i_d}]$  would give the nonzero element  $\text{LT}(f) \in \langle \text{LT}(I) \rangle \cap k[x_{i_1}, \dots, x_{i_d}]$ .

We can now prove that  $[x_{i_1}], \dots, [x_{i_d}] \in k[V]$  are algebraically independent over  $k$ . Let  $p$  be a polynomial with coefficients in  $k$  such that  $p([x_{i_1}], \dots, [x_{i_d}]) = [0]$ . Then  $[p(x_{i_1}, \dots, x_{i_d})] = [0]$  in  $k[V]$ , which shows that  $p(x_{i_1}, \dots, x_{i_d}) \in I$ . By (2), it follows that  $p(x_{i_1}, \dots, x_{i_d}) = 0$ , and since  $x_{i_1}, \dots, x_{i_d}$  are variables, we see that  $p$  is the zero polynomial. Since  $d = \dim V$ , we have found the desired number of algebraically independent elements.

The final step in the proof is to show that if  $r$  elements of  $k[V]$  are algebraically independent over  $k$ , then  $r \leq \dim V$ . So assume that  $[f_1], \dots, [f_r] \in k[V]$  are algebraically independent. Let  $N$  be the largest of the total degrees of  $f_1, \dots, f_r$  and let  $y_1, \dots, y_r$  be new variables. If  $p \in k[y_1, \dots, y_r]$  is a polynomial of total degree  $\leq s$ , then it is easy to check that the polynomial  $p(f_1, \dots, f_r) \in k[x_1, \dots, x_n]$  has total degree  $\leq Ns$  (see Exercise 2). Then consider the map

$$(3) \quad \alpha : k[y_1, \dots, y_r]_{\leq s} \longrightarrow k[x_1, \dots, x_n]_{\leq Ns} / I_{\leq Ns}$$

which sends  $p(y_1, \dots, y_r) \in k[y_1, \dots, y_r]_{\leq s}$  to the coset  $[p(f_1, \dots, f_r)] \in k[x_1, \dots, x_n]_{\leq Ns} / I_{\leq Ns}$ . We leave it as an exercise to show that  $\alpha$  is a well-defined linear map.

We claim that  $\alpha$  is one-to-one. To see why, suppose that  $p \in k[y_1, \dots, y_r]_{\leq s}$  and  $[p(f_1, \dots, f_r)] = [0]$  in  $k[x_1, \dots, x_n]_{\leq Ns} / I_{\leq Ns}$ . Using the map (1), it follows that

$$[p(f_1, \dots, f_r)] = p([f_1], \dots, [f_r]) = [0] \text{ in } k[x_1, \dots, x_n] / I \cong k[V].$$

Since  $[f_1], \dots, [f_r]$  are algebraically independent and  $p$  has coefficients in  $k$ , it follows that  $p$  must be the zero polynomial. Hence,  $\alpha$  is one-to-one.

Comparing dimensions in (3), we see that

$$(4) \quad {}^aHF_I(Ns) = \dim k[x_1, \dots, x_n]_{\leq Ns} / (I_{\leq Ns}) \geq \dim k[y_1, \dots, y_r]_{\leq s}.$$

Since  $y_1, \dots, y_r$  are variables, Lemma 4 of §2 shows that the dimension of  $k[y_1, \dots, y_r]_{\leq s}$  is  $\binom{r+s}{s}$ , which is a polynomial of degree  $r$  in  $s$ . In terms of the affine Hilbert polynomial, this implies

$${}^aHP_1(Ns) \geq \binom{r+s}{s} = \text{a polynomial of degree } r \text{ in } s$$

for  $s$  sufficiently large. It follows that  ${}^aHP_I(Ns)$  and, hence,  ${}^aHP_I(s)$  must have degree at least  $r$ . Thus,  $r \leq \dim V$ , which completes the proof of the theorem.  $\square$

As an application, we can show that isomorphic varieties have the same dimension.

**Corollary 3.** *Let  $V$  and  $V'$  be affine varieties which are isomorphic (as defined in Chapter 5, §4). Then  $\dim V = \dim V'$ .*

**Proof.** By Theorem 9 of Chapter 5, §4 we know  $V$  and  $V'$  are isomorphic if and only if there is a ring isomorphism  $\alpha : k[V] \rightarrow k[V']$  which is the identity on  $k$ . Then elements  $\phi_1, \dots, \phi_r \in k[V]$  are algebraically independent over  $k$  if and only if  $\alpha(\phi_1), \dots, \alpha(\phi_r) \in k[V']$  are. We leave the easy proof of this assertion as an exercise. From here, the corollary follows immediately from Theorem 2.  $\square$

In the proof of Theorem 2, note that the  $d = \dim V$  algebraically independent elements we found in  $k[V]$  came from the coordinates. We can use this to give another formulation of dimension.

**Corollary 4.** *Let  $V \subset k^n$  be an affine variety. Then the dimension of  $V$  is equal to the largest integer  $r$  for which there exist  $r$  variables  $x_{i_1}, \dots, x_{i_r}$  such that  $\mathbf{I}(V) \cap k[x_{i_1}, \dots, x_{i_r}] = \{0\}$  [that is, such that  $\mathbf{I}(V)$  does not contain any polynomial in these variables which is not identically zero].*

**Proof.** First, from (2), it follows that we can find  $d = \dim V$  such variables. Suppose that we could find  $d + 1$  variables,  $x_{j_1}, \dots, x_{j_{d+1}}$  such that  $I \cap k[x_{j_1}, \dots, x_{j_{d+1}}] = \{0\}$ . Then the argument following (2) would imply that  $[x_{j_1}, \dots, x_{j_{d+1}}] \in k[V]$  were algebraically independent over  $k$ . Since  $d = \dim V$ , this is impossible by Theorem 2.  $\square$

In the exercises, you will show that if  $k$  is algebraically closed, then Corollary 4 remains true if we replace  $\mathbf{I}(V)$  with *any* defining ideal  $I$  of  $V$ . Since we know how to compute  $I \cap k[x_{i_1}, \dots, x_{i_r}]$  by elimination theory, Corollary 4 then gives us an alternative method (though not an efficient one) for computing the dimension of a variety.

We can also interpret Corollary 4 in terms of projections. If we choose  $r$  variables  $x_{i_1}, \dots, x_{i_r}$ , then we get the projection map  $\pi : k^n \rightarrow k^r$  defined by  $\pi(a_1, \dots, a_n) = (a_{i_1}, \dots, a_{i_r})$ . Also, let  $\tilde{I} = \mathbf{I}(V) \cap k[x_{i_1}, \dots, x_{i_r}]$  be the appropriate elimination ideal. If  $k$  is algebraically closed, then the Closure Theorem from §2 of Chapter 3 shows that



$\mathbf{V}(\tilde{I}) \cap k^r$  is the smallest variety containing the projection  $\pi(V)$ . It follows that

$$\begin{aligned} \tilde{I} = \{0\} &\iff \mathbf{V}(\tilde{I}) = k^r \\ &\iff \text{the smallest variety containing } \pi(V) \text{ is } k^r. \end{aligned}$$

In general, a subset of  $k^r$  is said to be *Zariski dense* if the smallest variety containing it is  $k^r$ . Thus, Corollary 4 shows that the dimension of  $V$  is the largest dimension of a coordinate subspace for which the projection of  $V$  is Zariski dense in the subspace.

We can regard the above map  $\pi$  as a linear map from  $k^n$  to itself which leaves the  $i_j$ -th coordinate unchanged for  $1 \leq j \leq r$  and sends the other coordinates to 0. It is then easy to show that  $\pi \circ \pi = \pi$  and that the image of  $\pi$  is  $k^r \subset k^n$  (see Exercise 8). More generally, a linear map  $\pi : k^n \rightarrow k^n$  is called a *projection* if  $\pi \circ \pi = \pi$ . If  $\pi$  has rank  $r$ , then the image of  $\pi$  is an  $r$ -dimensional subspace  $H$  of  $k^n$ , and we say that  $\pi$  is a *projection onto  $H$* .

Now let  $\pi$  be a projection onto a subspace  $H \subset k^n$ . Under  $\pi$ , any variety  $V \subset k^n$  gives a subset  $\pi(V) \subset H$ . Then we can interpret the dimension of  $V$  in terms of its projections  $\pi(V)$  as follows.

**Proposition 5.** *Let  $k$  be an algebraically closed field and let  $V \subset k^n$  be an affine variety. Then the dimension of  $V$  is the largest dimension of a subspace  $H \subset k^n$  for which a projection of  $V$  onto  $H$  is Zariski dense.*

**Proof.** If  $V$  has dimension  $d$ , then by the above remarks, we can find a projection of  $V$  onto a  $d$ -dimensional coordinate subspace which has Zariski dense image.

Now let  $\pi : k^n \rightarrow k^n$  be an arbitrary projection onto an  $r$ -dimensional subspace  $H$  of  $k^n$ . We need to show that  $r \leq \dim V$  whenever  $\pi(V)$  is Zariski dense in  $H$ . From linear algebra, we can find a basis of  $k^n$  so that in the new coordinate system,  $\pi(a_1, \dots, a_n) = (a_1, \dots, a_r)$  [see, for example, section 3.4 of FINKBEINER (1978)]. Since changing coordinates does not affect the dimension (this follows from Corollary 3 since a coordinate change gives isomorphic varieties), we are reduced to the case of a projection onto a coordinate subspace, and then the proposition follows from the above remarks.  $\square$

Let  $\pi$  be a projection of  $k^n$  onto a subspace  $H$  of dimension  $r$ . By the Closure Theorem from Chapter 3, §2 we know that if  $\pi(V)$  is Zariski dense in  $H$ , then we can find a proper variety  $W \subset H$  such that  $H - W \subset \pi(V)$ . Thus,  $\pi(V)$  “fills up” most of the  $r$ -dimensional subspace  $H$ , and hence, it makes sense that this should force  $V$  to have dimension at least  $r$ . So Proposition 5 gives a very geometric way of thinking about the dimension of a variety.

For the final part of the section, we will assume that  $V$  is an *irreducible* variety. By Proposition 4 of Chapter 5, §1, we know that  $\mathbf{I}(V)$  is a prime ideal and that  $k[V]$  is an integral domain. As in §5 of Chapter 5, we can then form the field of fractions of  $k[V]$ , which is the *field of rational functions* on  $V$  and is denoted  $k(V)$ . For elements of  $k(V)$ , the definition of algebraic independence over  $k$  is the same as that given for elements of  $k[V]$  in Definition 1. We can relate the dimension of  $V$  to  $k(V)$  as follows.

**Theorem 6.** *Let  $V \subset k^n$  be an irreducible affine variety. Then the dimension of  $V$  equals the maximal number of elements of  $k(V)$  which are algebraically independent over  $k$ .*

**Proof.** Let  $d = \dim V$ . Since  $k[V] \subset k(V)$ , any  $d$  elements of  $k[V]$  which are algebraically independent over  $k$  will have the same property when regarded as elements of  $k(V)$ . So it remains to show that if  $\phi_1, \dots, \phi_r \in k(V)$  are algebraically independent, then  $r \leq \dim V$ . Each  $\phi_i$  is a quotient of elements of  $k[V]$ , and if we pick a common denominator  $f$ , then we can write  $\phi_i = [f_i]/[f]$  for  $1 \leq i \leq r$ . Note also that  $[f] \neq [0]$  in  $k[V]$ . We need to modify the proof of Theorem 2 to take the denominator  $f$  into account.

Let  $N$  be the largest of the total degrees of  $f, f_1, \dots, f_r$ , and let  $y_1, \dots, y_r$  be new variables. If  $p \in k[y_1, \dots, y_r]$  is a polynomial of total degree  $\leq s$ , then we leave it as an exercise to show that

$$f^s p(f_1/f, \dots, f_r/f)$$

is a polynomial in  $k[x_1, \dots, x_n]$  of total degree  $\leq Ns$  (see Exercise 10). Then consider the map

$$(5) \quad \beta : k[y_1, \dots, y_r]_{\leq s} \longrightarrow k[x_1, \dots, x_n]_{\leq Ns} / I_{\leq Ns}$$

sending a polynomial  $p(y_1, \dots, y_r) \in k[y_1, \dots, y_r]_{\leq s}$  to  $[f^s p(f_1/f, \dots, f_r/f)] \in k[x_1, \dots, x_n]_{\leq Ns} / I_{\leq Ns}$ . We leave it as an exercise to show that  $\beta$  is a well-defined linear map.

To show that  $\beta$  is one-to-one, suppose that  $p \in k[y_1, \dots, y_r]_{\leq s}$  and that  $[f^s p(f_1/f, \dots, f_r/f)] = [0]$  in  $k[x_1, \dots, x_n]_{\leq Ns} / I_{\leq Ns}$ . Using the map (1), it follows that

$$[f^s p(f_1/f, \dots, f_r/f)] = [0] \quad \text{in } k[x_1, \dots, x_n] / I \cong k[V].$$

However, if we work in  $k(V)$ , then we can write this as

$$[f]^s p([f_1]/[f], \dots, [f_r]/[f]) = [f]^s p(\phi_1, \dots, \phi_r) = [0] \quad \text{in } k(V).$$

Since  $k(V)$  is a field and  $[f] \neq [0]$ , it follows that  $p(\phi_1, \dots, \phi_r) = [0]$ . Then  $p$  must be the zero polynomial since  $\phi_1, \dots, \phi_r$  are algebraically independent and  $p$  has coefficients in  $k$ . Thus,  $\beta$  is one-to-one.

Once we know that  $\beta$  is one-to-one in (5), we get the inequality (4), and from here, the proof of Theorem 2 shows that  $\dim V \geq r$ . This proves the theorem.  $\square$

As a corollary of this theorem, we can prove that birationally equivalent varieties have the same dimension.

**Corollary 7.** *Let  $V$  and  $V'$  be irreducible affine varieties which are birationally equivalent (as defined in Chapter 5, §5). Then  $\dim V = \dim V'$ .*

**Proof.** In Theorem 10 of Chapter 5, §5, we showed that two irreducible affine varieties  $V$  and  $V'$  are birationally equivalent if and only if there is an isomorphism  $k(V) \cong k(V')$

of their function fields which is the identity on  $k$ . The remainder of the proof is identical to what we did in Corollary 3.  $\square$

In field theory, there is a concept of *transcendence degree* which is closely related to what we have been studying. In general, when we have a field  $K$  containing  $k$ , we have the following definition.

**Definition 8.** *Let  $K$  be a field containing  $k$ . Then we say that  $K$  has **transcendence degree  $d$  over  $k$**  provided that  $d$  is the largest number of elements of  $K$  which are algebraically independent over  $k$ .*

If we combine this definition with Theorem 6, then for any irreducible affine variety  $V$ , we have

$$\dim V = \text{the transcendence degree of } k(V) \text{ over } k.$$

Many books on algebraic geometry use this as the definition of the dimension of an irreducible variety. The dimension of an arbitrary variety is then defined to be the maximum of the dimensions of its irreducible components.

For an example of transcendence degree, suppose that  $k$  is infinite, so that  $k(V) = k(x_1, \dots, x_n)$  when  $V = k^n$ . Since  $k^n$  has dimension  $n$ , we conclude that the field  $k(x_1, \dots, x_n)$  has transcendence degree  $n$  over  $k$ . It is clear that the transcendence degree is at least  $n$ , but it is less obvious that no  $n + 1$  elements of  $k(x_1, \dots, x_n)$  can be algebraically independent over  $k$ . So our study of dimension yields some insights into the structure of fields.

To fully understand transcendence degree, one needs to study more about algebraic and transcendental field extensions. A good reference is Chapters VII and X of LANG (1965).

### EXERCISES FOR §5

1. Let  $\phi_1, \dots, \phi_r \in k[V]$  be algebraically independent over  $k$ .
  - a. Prove that the  $\phi_i$  are distinct and nonzero.
  - b. Prove that any nonempty subset of  $\{\phi_1, \dots, \phi_r\}$  consists of algebraically independent elements over  $k$ .
  - c. Let  $y_1, \dots, y_r$  be variables and consider the map  $\alpha : k[y_1, \dots, y_r] \rightarrow k[V]$  defined by  $\alpha(p) = p(\phi_1, \dots, \phi_r)$ . Show that  $\alpha$  is a one-to-one ring homomorphism.
2. This exercise is concerned with the proof of Theorem 2.
  - a. If  $f_1, \dots, f_r \in k[x_1, \dots, x_n]$  have total degree  $\leq N$  and  $p \in k[x_1, \dots, x_n]$  has total degree  $\leq s$ , show that  $p(f_1, \dots, f_r)$  has total degree  $\leq Ns$ .
  - b. Show that the map  $\alpha$  defined in the proof of Theorem 2 is a well-defined linear map.
3. Complete the proof of Corollary 3.
4. Let  $k$  be an algebraically closed field and let  $I \subset k[x_1, \dots, x_n]$  be an ideal. Show that the dimension of  $\mathbf{V}(I)$  is equal to the largest integer  $r$  for which there exist  $r$  variables  $x_{i_1}, \dots, x_{i_r}$  such that  $I \cap k[x_{i_1}, \dots, x_{i_r}] = \{0\}$ . Hint: Use  $I$  rather than  $\mathbf{I}(V)$  in the proof of Theorem 2. Be sure to explain why  $\dim V = \deg {}^aHP_I$ .

5. Let  $I = \langle xy - 1 \rangle \subset k[x, y]$ . What is the projection of  $\mathbf{V}(I)$  to the  $x$ -axis and to the  $y$ -axis? Note that  $\mathbf{V}(I)$  projects densely to both axes, but in neither case is the projection the whole axis.
6. Let  $k$  be infinite and let  $I = \langle xy, xz \rangle \subset k[x, y, z]$ .
  - a. Show that  $I \cap k[x] = 0$ , but that  $I \cap k[x, y]$  and  $I \cap k[x, z]$  are not equal to 0.
  - b. Show that  $I \cap k[y, z] = 0$ , but that  $I \cap k[x, y, z] \neq 0$ .
  - c. What do you conclude about the dimension of  $\mathbf{V}(I)$ ?
7. Here is a more complicated example of the phenomenon exhibited in Exercise 6. Again, assume that  $k$  is infinite and let  $I = \langle zx - x^2, zy - xy \rangle \subset k[x, y, z]$ .
  - a. Show that  $I \cap k[z] = 0$ . Is either  $I \cap k[x, z]$  or  $I \cap k[y, z]$  equal to 0?
  - b. Show that  $I \cap k[x, y] = 0$ , but that  $I \cap k[x, y, z] \neq 0$ .
  - c. What does part (b) say about  $\dim \mathbf{V}(I)$ ?
8. Given  $1 \leq i_1 < \dots < i_r \leq n$ , define a linear map  $\pi : k^n \rightarrow k^n$  by letting  $\pi(a_1, \dots, a_n)$  be the vector whose  $i_j$ th coordinate is  $a_{i_j}$ , for  $1 \leq j \leq r$  and whose other coordinates are 0. Show that  $\pi \circ \pi = \pi$  and determine the image of  $\pi$ .
9. In this exercise, we will show that there can be more than one projection onto a given subspace  $H \subset k^n$ .
  - a. Show that the matrices

$$\begin{pmatrix} 1 & 0 \\ 0 & 0 \end{pmatrix}, \begin{pmatrix} 1 & 1 \\ 0 & 0 \end{pmatrix}$$

both define projections from  $\mathbb{R}^2$  onto the  $x$ -axis. Draw a picture that illustrates what happens to a typical point of  $\mathbb{R}^2$  under each projection.

- b. Show that there is a one-to-one correspondence between projections of  $\mathbb{R}^2$  onto the  $x$ -axis and nonhorizontal lines in  $\mathbb{R}^2$  through the origin.
  - c. More generally, fix an  $r$ -dimensional subspace  $H \subset k^n$ . Show that there is a one-to-one correspondence between projections of  $k^n$  onto  $H$  and  $(n - r)$ -dimensional subspaces  $H' \subset k^n$  which satisfy  $H \cap H' = \{0\}$ . Hint: Consider the kernel of the projection.
10. This exercise is concerned with the proof of Theorem 6.
    - a. If  $f, f_1, \dots, f_r \in k[x_1, \dots, x_n]$  have total degree  $\leq N$  and  $p \in k[x_1, \dots, x_n]$  has total degree  $\leq s$ , show that  $f^s p(f_1/f, \dots, f_r/f)$  is a polynomial in  $k[x_1, \dots, x_n]$ .
    - b. Show that the polynomial of part (a) has total degree  $\leq Ns$ .
    - c. Show that the map  $\beta$  defined in the proof of Theorem 6 is a well-defined linear map.
  11. Complete the proof of Corollary 7.
  12. Suppose that  $\phi : V \rightarrow W$  is a polynomial map between affine varieties (see Chapter 5, §1). We proved in §4 of Chapter 5 that  $\phi$  induces a ring homomorphism  $\phi^* : k[W] \rightarrow k[V]$  which is the identity on  $k$ . From  $\phi$ , we get the subset  $\phi(V) \subset W$ . We say that  $\phi$  is *dominating* if the smallest variety of  $W$  containing  $\phi(V)$  is  $W$  itself. Thus,  $\phi$  is dominating if its image is Zariski dense in  $W$ .
    - a. Show that  $\phi$  is dominating if and only if the homomorphism  $\phi^* : k[W] \rightarrow k[V]$  is one-to-one. Hint: Show that  $W' \subset W$  is a proper subvariety if and only if there is nonzero element  $[f] \in k[W]$  such that  $W' \subset W \cap \mathbf{V}(f)$ .
    - b. If  $\phi$  is dominating, show that  $\dim V \geq \dim W$ . Hint: Use Theorem 2 and part (a).
  13. This exercise will study the relation between parametrizations and dimension. Assume that  $k$  is an infinite field.
    - a. Suppose that  $F : k^m \rightarrow V$  is a polynomial parametrization of a variety  $V$  (as defined in Chapter 3, §3). Thus,  $m$  is the number of parameters and  $V$  is the smallest variety containing  $F(k^m)$ . Prove that  $m \geq \dim V$ .
    - b. Give an example of a polynomial parametrization  $F : k^m \rightarrow V$  where  $m > \dim V$ .

- c. Now suppose that  $F : k^m - W \rightarrow V$  is a rational parametrization of  $V$  (as defined in Chapter 3, §3). We know that  $V$  is irreducible by Proposition 6 of Chapter 4, §5. Show that we can define a field homomorphism  $F^* : k(V) \rightarrow k(t_1, \dots, t_m)$  which is one-to-one. Hint: See the proof of Theorem 10 of Chapter 5, §5.
- d. If  $F : k^m - W \rightarrow V$  is a rational parametrization, show that  $m \geq \dim V$ .
14. In this exercise, we will show how to define the field of rational functions on an irreducible projective variety  $V \subset \mathbb{P}^n(k)$ . If we take a homogeneous polynomial  $f \in k[x_0, \dots, x_n]$ , then  $f$  does *not* give a well-defined function on  $V$ . To see why, let  $p \in V$  have homogeneous coordinates  $(a_0, \dots, a_n)$ . Then  $(\lambda a_0, \dots, \lambda a_n)$  are also homogeneous coordinates for  $p$ , and

$$f(\lambda a_0, \dots, \lambda a_n) = \lambda^d f(a_0, \dots, a_n),$$

where  $d$  is the total degree of  $f$ .

- a. Explain why the above equation makes it impossible for us to define  $f(p)$  as a single-valued function on  $V$ .
- b. If  $g \in k[x_0, \dots, x_n]$  also has total degree  $d$  and  $g \notin \mathbf{I}(V)$ , then show that  $\phi = f/g$  is a well-defined function on the nonempty set  $V - V \cap \mathbf{V}(g) \subset V$ .
- c. We say that  $\phi = f/g$  and  $\phi' = f'/g'$  are equivalent on  $V$ , written  $\phi \sim \phi'$ , provided that there is a proper variety  $W \subset V$  such that  $\phi = \phi'$  on  $V - W$ . Prove that  $\sim$  is an equivalence relation. An equivalence class for  $\sim$  is called a *rational function* on  $V$ , and the set of all equivalence classes is denoted  $k(V)$ . Hint: Your proof will use the fact that  $V$  is irreducible.
- d. Show that addition and multiplication of equivalence classes is well-defined and makes  $k(V)$  into a field. We call  $k(V)$  the *field of rational functions* of the projective variety  $V$ .
- e. If  $U_i$  is the affine part of  $\mathbb{P}^n(k)$  where  $x_i = 1$ , then we get an irreducible affine variety  $V \cap U_i \subset U_i \cong k^n$ . If  $V \cap U_i \neq \emptyset$ , show that  $k(V)$  is isomorphic to the field  $k(V \cap U_i)$  of rational functions on the affine variety  $V \cap U_i$ . Hint: You can assume  $i = 0$ . What do you get when you set  $x_0 = 1$  in the quotient  $f/g$  considered in part (b)?
15. Suppose that  $V \subset \mathbb{P}^n(k)$  is irreducible and let  $k(V)$  be its rational function field as defined in Exercise 14.
- a. Prove that  $\dim V$  is the transcendence degree of  $k(V)$  over  $k$ . Hint: Reduce to the affine case.
- b. We say that two irreducible projective varieties  $V$  and  $V'$  (lying possibly in different projective spaces) are *birationally equivalent* if any of their affine portions  $V \cap U_i$  and  $V' \cap U_j$  are birationally equivalent in the sense of Chapter 5, §5. Prove that  $V$  and  $V'$  are birationally equivalent if and only if there is a field isomorphism  $k(V) \cong k(V')$  which is the identity on  $k$ . Hint: Use the previous exercise and Theorem 10 of Chapter 5, §5.
- c. Prove that birationally equivalent projective varieties have the same dimension.

## §6 Dimension and Nonsingularity

This section will explore how dimension is related to the geometric properties of a variety  $V$ . The discussion will be rather different from §5, where the algebraic properties of  $k[V]$  and  $k(V)$  played a dominant role. We will introduce some rather sophisticated concepts, and some of the theorems will be proved only in special cases. For convenience, we will assume that  $V$  is always an affine variety.

When we look at a surface  $V \subset \mathbb{R}^3$ , one intuitive reason for saying that it is 2-dimensional is that at a point  $p$  on  $V$ , a small portion of the surface looks like a small

portion of the plane. This is reflected by the way the tangent plane approximates  $V$  at  $p$ :

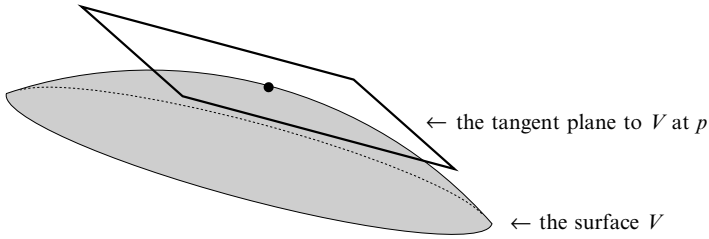

Of course, we have to be careful because the surface may have points where there does not seem to be a tangent plane. For example, consider the cone  $V(x^2 + y^2 - z^2)$ . There seems to be a nice tangent plane everywhere except at the origin:

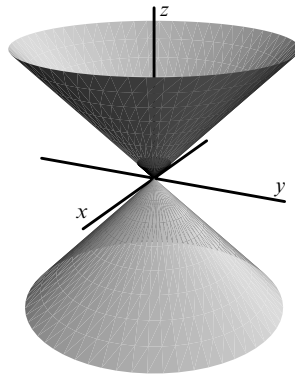

In this section, we will introduce the concept of a *nonsingular point*  $p$  of a variety  $V$ , and we will give a careful definition of the *tangent space*  $T_p(V)$  of  $V$  at  $p$ . Our discussion will generalize what we did for curves in §4 of Chapter 3. The tangent space gives useful information about how the variety  $V$  behaves near the point  $p$ . This is the so-called “local viewpoint.” Although we have not discussed this topic previously, it plays an important role in algebraic geometry. In general, properties which reflect the behavior of a variety near a given point are called *local properties*.

We begin with a discussion of the tangent space. For a curve  $V$  defined by an equation  $f(x, y) = 0$  in  $\mathbb{R}^2$ , we saw in Chapter 3 that the line tangent to the curve at a point  $(a, b) \in V$  is defined by the equation

$$\frac{\partial f}{\partial x}(a, b) \cdot (x - a) + \frac{\partial f}{\partial y}(a, b) \cdot (y - b) = 0,$$

provided that the two partial derivatives do not vanish (see Exercise 4 of Chapter 3, §4). We can generalize this to an arbitrary variety as follows.

**Definition 1.** Let  $V \subset k^n$  be an affine variety and let  $p = (p_1, \dots, p_n) \in V$  be a point.

- (i) If  $f \in k[x_1, \dots, x_n]$  is a polynomial, the **linear part** of  $f$  at  $p$ , denoted  $d_p(f)$ , is defined to be the polynomial

$$d_p(f) = \frac{\partial f}{\partial x_1}(p)(x_1 - p_1) + \dots + \frac{\partial f}{\partial x_n}(p)(x_n - p_n).$$

Note that  $d_p(f)$  has total degree  $\leq 1$ .

- (ii) The **tangent space** of  $V$  at  $p$ , denoted  $T_p(V)$ , is the variety

$$T_p(V) = \mathbf{V}(d_p(f) : f \in \mathbf{I}(V)).$$

If we are working over  $\mathbb{R}$ , then the partial derivative  $\frac{\partial f}{\partial x_i}$  has the usual meaning. For other fields, we use the *formal partial derivative*, which is defined by

$$\frac{\partial}{\partial x_i} \left( \sum_{\alpha_1, \dots, \alpha_n} c_{\alpha_1 \dots \alpha_n} x_1^{\alpha_1} \dots x_i^{\alpha_i} \dots x_n^{\alpha_n} \right) = \sum_{\alpha_1, \dots, \alpha_n} c_{\alpha_1 \dots \alpha_n} \alpha_i x_1^{\alpha_1} \dots x_i^{\alpha_i - 1} \dots x_n^{\alpha_n}.$$

In Exercise 1, you will show that the usual rules of differentiation apply to  $\frac{\partial}{\partial x_i}$ . We first prove some simple properties of  $T_p(V)$ .

**Proposition 2.** Let  $p \in V \subset k^n$ .

- (i) If  $\mathbf{I}(V) = \langle f_1, \dots, f_s \rangle$  then  $T_p(V) = \mathbf{V}(d_p(f_1), \dots, d_p(f_s))$ .  
 (ii)  $T_p(V)$  is the translate of a linear subspace of  $k^n$ .

**Proof.** (i) By the product rule, it is easy to show that

$$d_p(hf) = h(p) \cdot d_p(f) + d_p(h) \cdot f(p)$$

(see Exercise 2). This implies  $d_p(hf) = h(p) \cdot d_p(f)$  when  $f(p) = 0$ , and it follows that if  $g = \sum_{i=1}^s h_i f_i \in \mathbf{I}(V) = \langle f_1, \dots, f_s \rangle$ , then

$$d_p(g) = \sum_{i=1}^s d_p(h_i f_i) = \sum_{i=1}^s h_i(p) \cdot d_p(f_i) \in \langle d_p(f_1), \dots, d_p(f_s) \rangle.$$

This shows that  $T_p(V)$  is defined by the vanishing of the  $d_p(f_i)$ .

(ii) Introduce new coordinates on  $k^n$  by setting  $X_i = x_i - p_i$  for  $1 \leq i \leq n$ . This coordinate system is obtained by translating  $p$  to the origin. By part (i), we know that  $T_p(V)$  is given by  $d_p(f_1) = \dots = d_p(f_s) = 0$ . Since each  $d_p(f_i)$  is linear in  $X_1, \dots, X_n$ , it follows that  $T_p(V)$  is a linear subspace with respect to the  $X_i$ . In terms of the original coordinates, this means that  $T_p(V)$  is the translate of a subspace of  $k^n$ . □

We can get an intuitive idea of what the tangent space means by thinking about *Taylor's formula* for a polynomial of several variables. For a polynomial of one variable, one has the standard formula

$$f(x) = f(a) + f'(a)(x - a) + \text{terms involving higher powers of } x - a.$$

For  $f \in k[x_1, \dots, x_n]$ , you will show in Exercise 3 that if  $p = (p_1, \dots, p_n)$ , then

$$f = f(p) + \frac{\partial f}{\partial x_1}(p)(x_1 - p_1) + \dots + \frac{\partial f}{\partial x_n}(p)(x_n - p_n) \\ + \text{terms of total degree } \geq 2 \text{ in } x_1 - p_1, \dots, x_n - p_n.$$

This is part of Taylor’s formula for  $f$  at  $p$ . When  $p \in V$  and  $f \in \mathbf{I}(V)$ , we have  $f(p) = 0$ , so that

$$f = d_p(f) + \text{terms of total degree } \geq 2 \text{ in } x_1 - p_1, \dots, x_n - p_n.$$

Thus  $d_p(f)$  is the best linear approximation of  $f$  near  $p$ . Now suppose that  $\mathbf{I}(V) = \langle f_1, \dots, f_s \rangle$ . Then  $V$  is defined by the vanishing of the  $f_i$ , so that the best linear approximation to  $V$  near  $p$  should be defined by the vanishing of the  $d_p(f_i)$ . By Proposition 2, this is exactly the tangent space  $T_p(V)$ .

We can also think about  $T_p(V)$  in terms of lines that meet  $V$  with “higher multiplicity” at  $p$ . In Chapter 3, this was how we defined the tangent line for curves in the plane. In the higher dimensional case, suppose that we have  $p \in V$  and let  $L$  be a line through  $p$ . We can parametrize  $L$  by  $F(t) = p + tv$ , where  $v \in k^n$  is a vector parallel to  $L$ . If  $f \in k[x_1, \dots, x_n]$ , then  $f \circ F(t)$  is a polynomial in the variable  $t$ , and note that  $f \circ F(0) = f(p)$ . Thus, 0 is a root of this polynomial whenever  $f \in \mathbf{I}(V)$ . We can use the multiplicity of this root to decide when  $L$  is contained in  $T_p(V)$ .

**Proposition 3.** *If  $L$  is a line through  $p$  parametrized by  $F(t) = p + tv$ , then  $L \subset T_p(V)$  if and only if 0 is a root of multiplicity  $\geq 2$  of  $f \circ F(t)$  for all  $f \in \mathbf{I}(V)$ .*

**Proof.** If we write the parametrization of  $L$  as  $x_i = p_i + tv_i$  for  $1 \leq i \leq n$ , where  $p = (p_1, \dots, p_n)$  and  $v = (v_1, \dots, v_n)$ , then, for any  $f \in \mathbf{I}(V)$ , we have

$$g(t) = f \circ F(t) = f(p_1 + v_1t, \dots, p_n + tv_n).$$

As we noted above,  $g(0) = 0$  because  $p \in V$ , so that  $t = 0$  is a root of  $g(t)$ . In Exercise 5 of Chapter 3, §4, we showed that  $t = 0$  is a root of multiplicity  $\geq 2$  if and only if we also have  $g'(0) = 0$ . Using the chain rule for functions of several variables, we obtain

$$\frac{dg}{dt} = \frac{\partial f}{\partial x_1} \frac{dx_1}{dt} + \dots + \frac{\partial f}{\partial x_n} \frac{dx_n}{dt} = \frac{\partial f}{\partial x_1} v_1 + \dots + \frac{\partial f}{\partial x_n} v_n.$$

It follows that that  $g'(0) = 0$  if and only if

$$0 = \sum_{i=1}^n \frac{\partial f}{\partial x_i}(p)v_i = \sum_{i=1}^n \frac{\partial f}{\partial x_i}(p)((p_i + v_i) - p_i).$$

The expression on the right in this equation is  $d_p(f)$  evaluated at the point  $p + v \in L$ , and it follows that  $p + v \in T_p(V)$  if and only if  $g'(0) = 0$  for all  $f \in \mathbf{I}(V)$ . Since  $p \in L$ , we know that  $L \subset T_p(V)$  is equivalent to  $p + v \in T_p(V)$ , and the proposition is proved.  $\square$

It is time to look at some examples.



**Example 4.** Let  $V \subset \mathbb{C}^n$  be the hypersurface defined by  $f = 0$ , where  $f \in k[x_1, \dots, x_n]$  is a nonconstant polynomial. By Proposition 9 of Chapter 4, §2, we have

$$\mathbf{I}(V) = \mathbf{I}(\mathbf{V}(f)) = \sqrt{\langle f \rangle} = \langle f_{red} \rangle,$$

where  $f_{red} = f_1 \cdots f_r$  is the product of the distinct irreducible factors of  $f$ . We will assume that  $f = f_{red}$ . This implies that

$$V = \mathbf{V}(f) = \mathbf{V}(f_1 \cdots f_r) = \mathbf{V}(f_1) \cup \cdots \cup \mathbf{V}(f_r)$$

is the decomposition of  $V$  into irreducible components (see Exercise 9 of Chapter 4, §6). In particular, every component of  $V$  has dimension  $n - 1$  by the affine version of Proposition 2 of §4.

Since  $\mathbf{I}(V) = \langle f \rangle$ , it follows from Proposition 2 that for any  $p \in V$ ,  $T_p(V)$  is the linear space defined by the single equation

$$\frac{\partial f}{\partial x_1}(p)(x_1 - p_1) + \cdots + \frac{\partial f}{\partial x_n}(p)(x_n - p_n) = 0.$$

This implies that

$$(1) \quad \dim T_p(V) = \begin{cases} n - 1 & \text{at least one } \frac{\partial f}{\partial x_i}(p) \neq 0 \\ n & \text{all } \frac{\partial f}{\partial x_i}(p) = 0. \end{cases}$$

You should check how this generalizes Proposition 2 of Chapter 3, §4.

For a specific example, consider  $V = \mathbf{V}(x^2 - y^2z^2 + z^3)$ . In Exercise 4, you will show that  $f = x^2 - y^2z^2 + z^3 \in \mathbb{C}[x, y, z]$  is irreducible, so that  $\mathbf{I}(V) = \langle f \rangle$ . The partial derivatives of  $f$  are

$$\frac{\partial f}{\partial x} = 2x, \quad \frac{\partial f}{\partial y} = -2yz^2, \quad \frac{\partial f}{\partial z} = -2y^2z + 3z^2.$$

We leave it as an exercise to show that on  $V$ , the partials vanish simultaneously only on the  $y$ -axis, which lies in  $V$ . Thus, the tangent spaces  $T_p(V)$  are all 2-dimensional, except along the  $y$ -axis, where they are all of  $\mathbb{C}^3$ . Over  $\mathbb{R}$ , we get the following picture of  $V$  (which appeared earlier in §2 of Chapter 1):

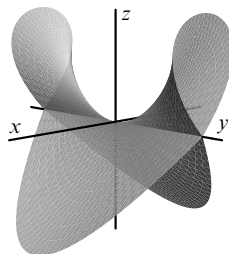

When we give the definition of nonsingular point later in this section, we will see that the points of  $V$  on the  $y$ -axis are the singular points, whereas other points of  $V$  are nonsingular.

**Example 5.** Now consider the curve  $C \subset \mathbb{C}^3$  obtained by intersecting the surface  $V$  of Example 4 with the plane  $x + y + z = 0$ . Thus,  $C = V(x + y + z, x^2 - y^2z^2 + z^3)$ . Using the techniques of §3, you can verify that  $\dim C = 1$ .

In the exercises, you will also show that  $\langle f_1, f_2 \rangle = \langle x + y + z, x^2 - y^2z^2 + z^3 \rangle$  is a prime ideal, so that  $C$  is an irreducible curve. Since a prime ideal is radical, the Nullstellensatz implies that  $\mathbf{I}(C) = \langle f_1, f_2 \rangle$ . Thus, for  $p = (a, b, c) \in C$ , it follows that  $T_p(C)$  is defined by the linear equations

$$\begin{aligned} d_p(f_1) &= 1 \cdot (x - a) + 1 \cdot (y - b) + 1 \cdot (z - c) = 0, \\ d_p(f_2) &= 2a \cdot (x - a) + (-2bc^2) \cdot (y - b) + (-2b^2c + 3c^2) \cdot (z - c) = 0. \end{aligned}$$

This is a system of linear equations in  $x - a, y - b, z - c$ , and the matrix of coefficients is

$$J_p(f_1, f_2) = \begin{pmatrix} 1 & 1 & 1 \\ 2a & -2bc^2 & -2b^2c + 3c^2 \end{pmatrix}.$$

Let  $\text{rank}(J_p(f_1, f_2))$  denote the rank of this matrix. Since  $T_p(C)$  is a translate of the kernel of  $J_p(f_1, f_2)$ , it follows that

$$\dim T_p(C) = 3 - \text{rank}(J_p(f_1, f_2)).$$

In the exercises, you will show that  $T_p(C)$  is 1-dimensional at all points of  $C$  except for the origin, where  $T_0(C)$  is the 2-dimensional plane  $x + y + z = 0$ .

In these examples, we were careful to always compute  $\mathbf{I}(V)$ . It would be much nicer if we could use any set of defining equations of  $V$ . Unfortunately, this does not always work: if  $V = \mathbf{V}(f_1, \dots, f_s)$ , then  $T_p(V)$  need *not* be defined by  $d_p(f_1) = \dots = d_p(f_s) = 0$ . For example, let  $V$  be the  $y$ -axis in  $k^2$ . Then  $V$  is defined by  $x^2 = 0$ , but you can easily check that  $T_p(V) \neq \mathbf{V}(d_p(x^2))$  for all  $p \in V$ . However, in Theorem 9, we will find a nice condition on  $f_1, \dots, f_s$  which, when satisfied, will allow us to compute  $T_p(V)$  using the  $d_p(f_i)$ 's.

Examples 4 and 5 indicate that the nicest points on  $V$  are the ones where  $T_p(V)$  has the same dimension as  $V$ . But this principle does not apply when  $V$  has irreducible components of different dimensions. For example, let  $V = V(xz, yz) \subset \mathbb{R}^3$ . This is the union of the  $(x, y)$ -plane and the  $z$ -axis, and it is easy to check that

$$\dim T_p(V) = \begin{cases} 2 & p \text{ is on the } (x, y)\text{-plane minus the origin} \\ 1 & p \text{ is on the } z\text{-axis minus the origin} \\ 3 & p \text{ is the origin.} \end{cases}$$

Excluding the origin, points on the  $z$ -axis have a 1-dimensional tangent space, which seems intuitively correct. Yet at such a point, we have  $\dim T_p(V) < \dim V$ . The problem, of course, is that we are on a component of the wrong dimension.

To avoid this difficulty, we need to define the dimension of a variety at a point.

**Definition 6.** Let  $V$  be an affine variety. For  $p \in V$ , the **dimension of  $V$  at  $p$** , denoted  $\dim_p V$ , is the maximum dimension of an irreducible component of  $V$  containing  $p$ .

By Corollary 9 of §4, we know that  $\dim V$  is the maximum of  $\dim_p V$  as  $p$  varies over all points of  $V$ . If  $V$  is a hypersurface in  $\mathbb{C}^n$ , it is easy to compute  $\dim_p V$ , for in Example 4, we showed that every irreducible component of  $V$  has dimension  $n - 1$ . It follows that  $\dim_p V = n - 1$  for all  $p \in V$ . On the other hand, if  $V \subset k^n$  is an arbitrary variety, the theory developed in §§3 and 4 enables us to compute  $\dim V$ , but unless we know how to decompose  $V$  into irreducible components, more subtle tools are needed to compute  $\dim_p V$ . This will be discussed in §7 when we study the properties of the tangent cone.

We can now define what it means for a point  $p \in V$  to be nonsingular.

**Definition 7.** Let  $p$  be a point on an affine variety  $V$ . Then  $p$  is **nonsingular** (or **smooth**) provided  $\dim T_p(V) = \dim_p V$ . Otherwise,  $p$  is a **singular point** of  $V$ .

If we look back at our previous examples, it is easy to identify which points are nonsingular and which are singular. In Example 5, the curve  $C$  is irreducible, so that  $\dim_p C = 1$  for all  $p \in C$  and, hence, the singular points are where  $\dim T_p(C) \neq 1$  (only one in this case). For the hypersurfaces  $V = \mathbf{V}(f)$  considered in Example 4, we know that  $\dim_p V = n - 1$  for all  $p \in V$ , and it follows from (1) so that  $p$  is singular if and only if all of the partial derivatives of  $f$  vanish at  $p$ . This means that the singular points of  $V$  form the variety

$$(2) \quad \Sigma = \mathbf{V}\left(f, \frac{\partial f}{\partial x_1}, \dots, \frac{\partial f}{\partial x_n}\right).$$

In general, the singular points of a variety  $V$  have the following properties.

**Theorem 8.** Let  $V \subset k^n$  be an affine variety and let

$$\Sigma = \{p \in V : p \text{ is a singular point of } V\}.$$

We call  $\Sigma$  the **singular locus** of  $V$ . Then:

- (i)  $\Sigma$  is an affine variety contained in  $V$ .
- (ii) If  $p \in \Sigma$ , then  $\dim T_p(V) > \dim_p V$ .
- (iii)  $\Sigma$  contains no irreducible component of  $V$ .
- (iv) If  $V_i$  and  $V_j$  are distinct irreducible components of  $V$ , then  $V_i \cap V_j \subset \Sigma$ .

**Proof.** A complete proof of this theorem is beyond the scope of the book. Instead, we will assume that  $V$  is a hypersurface in  $\mathbb{C}^n$  and show that the theorem holds in this case. As we discuss each part of the theorem, we will give references for the general case.

Let  $V = \mathbf{V}(f) \subset \mathbb{C}^n$  be a hypersurface such that  $\mathbf{I}(V) = \langle f \rangle$ . We noted earlier that  $\dim_p V = n - 1$  and that  $\Sigma$  consists of those points of  $V$  where all of the partial derivatives of  $f$  vanish simultaneously. Then (2) shows that  $\Sigma$  is an affine variety,

which proves (i) for hypersurfaces. A proof in the general case is given in the Corollary to Theorem 6 in Chapter II, §2 of SHAFAREVICH (1974).

Part (ii) of the theorem says that at a singular point of  $V$ , the tangent space is too big. When  $V$  is a hypersurface in  $\mathbb{C}^n$ , we know from (1) that if  $p$  is a singular point, then  $\dim T_p(V) = n > n - 1 = \dim_p V$ . This proves (ii) for hypersurfaces, and the general case follows from Theorem 3 in Chapter II, §1 of SHAFAREVICH (1974).

Part (iii) says that on each irreducible component of  $V$ , the singular locus consists of a proper subvariety. Hence, most points of a variety are nonsingular. To prove this for a hypersurface, let  $V = \mathbf{V}(f) = \mathbf{V}(f_1) \cup \cdots \cup \mathbf{V}(f_r)$  be the decomposition of  $V$  into irreducible components, as discussed in Example 4. Suppose that  $\Sigma$  contains one of the components, say  $\mathbf{V}(f_1)$ . Then every  $\frac{\partial f}{\partial x_i}$  vanishes on  $\mathbf{V}(f_1)$ . If we write  $f = f_1 g$ , where  $g = f_2 \cdots f_r$ , then

$$\frac{\partial f}{\partial x_i} = f_1 \frac{\partial g}{\partial x_i} + \frac{\partial f_1}{\partial x_i} g$$

by the product rule. Since  $f_1$  certainly vanishes on  $\mathbf{V}(f_1)$ , it follows that  $\frac{\partial f_1}{\partial x_i} g$  also vanishes on  $\mathbf{V}(f_1)$ . By assumption,  $f_1$  is irreducible, so that

$$\frac{\partial f_1}{\partial x_i} g \in \mathbf{I}(\mathbf{V}(f_1)) = \langle f_1 \rangle.$$

This says that  $f_1$  divides  $\frac{\partial f_1}{\partial x_i} g$  and, hence,  $f_1$  divides  $\frac{\partial f_1}{\partial x_i}$  or  $g$ . The latter is impossible since  $g$  is a product of irreducible polynomials distinct from  $f_1$  (meaning that none of them is a constant multiple of  $f_1$ ). Thus,  $f_1$  must divide  $\frac{\partial f_1}{\partial x_i}$  for all  $i$ . Since  $\frac{\partial f_1}{\partial x_i}$  has smaller total degree than  $f_1$ , we must have  $\frac{\partial f_1}{\partial x_i} = 0$  for all  $i$ , and it follows that  $f_1$  is constant (see Exercise 9). This contradiction proves that  $\Sigma$  contains no component of  $V$ .

When  $V$  is an arbitrary irreducible variety, a proof that  $\Sigma$  is a proper subvariety can be found in the corollary to Theorems 4.1 and 4.3 in Chapter IV of KENDIG (1977). See also the discussion preceding the definition of singular point in Chapter II, §1 of SHAFAREVICH (1974). If  $V$  has two or more irreducible components, the claim follows from the irreducible case and part (iv) below. See Exercise 11 for the details.

Finally, part (iv) of the theorem says that a nonsingular point of a variety lies on a unique irreducible component. In the hypersurface case, suppose that  $V = \mathbf{V}(f) = \mathbf{V}(f_1) \cup \cdots \cup \mathbf{V}(f_r)$  and that  $p \in \mathbf{V}(f_i) \cap \mathbf{V}(f_j)$  for  $i \neq j$ . Then we can write  $f = gh$ , where  $f_i$  divides  $g$  and  $f_j$  divides  $h$ . Hence,  $g(p) = h(p) = 0$ , and then an easy argument using the product rule shows that  $\frac{\partial f}{\partial x_i}(p) = 0$  for all  $i$ . This proves that  $\mathbf{V}(f_i) \cap \mathbf{V}(f_j) \subset \Sigma$ , so that (iv) is true for hypersurfaces. When  $V$  is an arbitrary variety, see Theorem 6 in Chapter II, §2 of SHAFAREVICH (1974).  $\square$

In some cases, it is also possible to show that a point of a variety  $V$  is nonsingular without having to compute  $\mathbf{I}(V)$ . To formulate a precise result, we will need some notation. Given  $f_1, \dots, f_r \in k[x_1, \dots, x_n]$ , let  $J(f_1, \dots, f_r)$  be the  $r \times n$  matrix of

partial derivatives

$$J(f_1, \dots, f_r) = \begin{pmatrix} \frac{\partial f_1}{\partial x_1} & \cdots & \frac{\partial f_1}{\partial x_n} \\ \vdots & & \vdots \\ \frac{\partial f_r}{\partial x_1} & \cdots & \frac{\partial f_r}{\partial x_n} \end{pmatrix}.$$

Given  $p \in k^n$ , evaluating this matrix at  $p$  gives an  $r \times n$  matrix of numbers denoted  $J_p(f_1, \dots, f_r)$ . Then we have the following result.

**Theorem 9.** *Let  $V = \mathbf{V}(f_1, \dots, f_r) \subset \mathbb{C}^n$  be an arbitrary variety and suppose that  $p \in V$  is a point where  $J_p(f_1, \dots, f_r)$  has rank  $r$ . Then  $p$  is a nonsingular point of  $V$  and lies on a unique irreducible component of  $V$  of dimension  $n - r$ .*

**Proof.** As with Theorem 8, we will only prove this for a hypersurface  $V = \mathbf{V}(f) \subset \mathbb{C}^n$ , which is the case  $r = 1$  of the theorem. Here, note that  $f$  is now *any* defining equation of  $V$ , and, in particular, it could happen that  $\mathbf{I}(V) \neq \langle f \rangle$ . But we still know that  $f$  vanishes on  $V$ , and it follows from the definition of tangent space that

$$(3) \quad T_p(V) \subset \mathbf{V}(d_p(f)).$$

Since  $r = 1$ ,  $J_p(f)$  is the row vector whose entries are  $\frac{\partial f}{\partial x_i}(p)$ , and our assumption that  $J_p(f)$  has rank 1 implies that at least one of the partials is nonzero at  $p$ . Thus,  $d_p(f)$  is a nonzero linear function of  $x_i - p_i$ , and it follows from (3) that  $\dim T_p(V) \leq n - 1$ . If we compare this to (1), we see that  $p$  is a nonsingular point of  $V$ , and by part (iv) of Theorem 8, it lies on a unique irreducible component of  $V$ . Since the component has the predicted dimension  $n - r = n - 1$ , we are done. For the general case, see Theorem (1.16) of MUMFORD (1976).  $\square$

Theorem 9 is important for several reasons. First of all, it is very useful for determining the nonsingular points and dimension of a variety. For instance, it is now possible to redo Examples 4 and 5 without having to compute  $\mathbf{I}(V)$  and  $\mathbf{I}(C)$ . Another aspect of Theorem 9 is that it relates nicely to our intuition that the dimension should drop by one for each equation defining  $V$ . This is what happens in the theorem, and in fact we can sharpen our intuition as follows. Namely, the dimension should drop by one for each defining equation, provided the defining equations are sufficiently independent [which means that  $\text{rank}(J_p(f_1, \dots, f_r)) = r$ ]. In Exercise 16, we see a more precise way to state this. Furthermore, note that our intuition applies to the nonsingular part of  $V$ .

Theorem 9 is also related to some important ideas from advanced courses in the calculus of several variables. In particular, the *Implicit Function Theorem* has the same hypothesis concerning  $J_p(f_1, \dots, f_r)$  as Theorem 9. When  $V = \mathbf{V}(f_1, \dots, f_r)$  satisfies this hypothesis, the complex variable version of the Implicit Function Theorem asserts that near  $p$ , the variety  $V$  looks like the graph of a nice function, and we get a vivid picture of why  $V$  has dimension  $n - r$  at  $p$ . To understand the full meaning of Theorem 9, one needs to study the notion of a *manifold*. A nice discussion of this topic and its relation to nonsingularity and dimension can be found in KENDIG (1977).

**EXERCISES FOR §6**

1. We will discuss the properties of the formal derivative defined in the text.
  - a. Show that  $\frac{\partial}{\partial x_i}$  is  $k$ -linear and satisfies the product rule.
  - b. Show that  $\frac{\partial}{\partial x_i} \left( \frac{\partial}{\partial x_j} f \right) = \frac{\partial}{\partial x_j} \left( \frac{\partial}{\partial x_i} f \right)$  for all  $i$  and  $j$ .
  - c. If  $f_1, \dots, f_r \in k[x_1, \dots, x_n]$ , compute  $\frac{\partial}{\partial x_i} (f_1^{\alpha_1} \dots f_r^{\alpha_r})$ .
  - d. Formulate and prove a version of the chain rule for computing the partial derivatives of a polynomial of the form  $F(f_1, \dots, f_r)$ . Hint: Use part (c).
2. Prove that  $d_p(hf) = h(p) \cdot d_p(f) + d_p(h) \cdot f(p)$ .
3. Let  $p = (p_1, \dots, p_n) \in k^n$  and let  $f \in k[x_1, \dots, x_n]$ .
  - a. Show that  $f$  can be written as a polynomial in  $x_i - p_i$ . Hint:  $x_i^m = ((x_i - p_i) + p_i)^m$ .
  - b. Suppose that when we write  $f$  as a polynomial in  $x_i - p_i$ , every term has total degree at least 2. Show that  $\frac{\partial f}{\partial x_i}(p) = 0$  for all  $i$ .
  - c. If we write  $f$  as a polynomial in  $x_i - p_i$ , show that the constant term is  $f(p)$  and the linear term is  $d_p(f)$ . Hint: Use part (b).
4. As in Example 4, let  $f = x^2 - y^2z^2 + z^3 \in \mathbb{C}[x, y, z]$  and let  $V = \mathbf{V}(f) \subset \mathbb{C}^3$ .
  - a. Show carefully that  $f$  is irreducible in  $\mathbb{C}[x, y, z]$ .
  - b. Show that  $V$  contains the  $y$ -axis.
  - c. Let  $p \in V$ . Show that the partial derivatives of  $f$  all vanish at  $p$  if and only if  $p$  lies on the  $y$ -axis.
5. Let  $A$  be an  $m \times n$  matrix, where  $n \geq m$ . If  $r \leq m$ , we say that a matrix  $B$  is an  $r \times r$  submatrix of  $A$  provided that  $B$  is the matrix obtained by first selecting  $r$  columns of  $A$ , and then selecting  $r$  rows from those columns.
  - a. Pick a  $3 \times 4$  matrix of numbers and write down all of its  $3 \times 3$  and  $2 \times 2$  submatrices.
  - b. Show that  $A$  has rank  $< r$  if and only if all  $t \times t$  submatrices of  $A$  have determinant zero for all  $r \leq t \leq m$ . Hint: The rank of a matrix is the maximum number of linearly independent columns. If  $A$  has rank  $s$ , it follows that you can find an  $m \times s$  submatrix of rank  $s$ . Now use the fact that the rank is also the maximum number of linearly independent rows. What is the criterion for an  $r \times r$  matrix to have rank  $< r$ ?
6. As in Example 5, let  $C = \mathbf{V}(x + y + z, x^2 - y^2z^2 + z^3) \subset \mathbb{C}^3$  and let  $I$  be the ideal  $I = (x + y + z, x^2 - y^2z^2 + z^3) \subset \mathbb{C}[x, y, z]$ .
  - a. Show that  $I$  is a prime ideal. Hint: Introduce new coordinates  $X = x + y + z, Y = y$ , and  $Z = z$ . Show that  $I = \langle X, F(Y, Z) \rangle$  for some polynomial in  $Y, Z$ . Prove that  $\mathbb{C}[X, Y, Z]/I \cong \mathbb{C}[Y, Z]/\langle F \rangle$  and show that  $F \in \mathbb{C}[Y, Z]$  is irreducible.
  - b. Conclude that  $C$  is an irreducible variety and that  $\mathbf{I}(C) = I$ .
  - c. Compute the dimension of  $C$ .
  - d. Determine all points  $(a, b, c) \in C$  such that the  $2 \times 3$  matrix

$$J_p(f_1, f_2) = \begin{pmatrix} 1 & 1 & 1 \\ 2a & -2bc^2 & -2b^2c + 3c^2 \end{pmatrix}$$

has rank  $< 2$ . Hint: Use Exercise 5.

7. Let  $f = x^2 \in k[x, y]$ . In  $k^2$ , show that  $T_p(\mathbf{V}(f)) \neq \mathbf{V}(d_p(f))$  for all  $p \in V$ .
8. Let  $V = \mathbf{V}(xy, xz) \subset k^3$  and assume that  $k$  is an infinite field.
  - a. Compute  $\mathbf{I}(V)$ .
  - b. Verify the formula for  $\dim T_p(V)$  given in the text.
9. Suppose that  $f \in k[x_1, \dots, x_n]$  is a polynomial such that  $\frac{\partial}{\partial x_i} f = 0$  for all  $i$ . If  $k$  has characteristic 0 (which means that  $k$  contains a field isomorphic to  $\mathbb{Q}$ ), then show that  $f$  must be the constant.

10. The result of Exercise 9 may be false if  $k$  does not have characteristic 0.
- Let  $f = x^2 + y^2 \in \mathbb{F}_2[x, y]$ , where  $\mathbb{F}_2$  is a field with two elements. What are the partial derivatives of  $f$ ?
  - To analyze the case when  $k$  does not have characteristic 0, we need to define the *characteristic* of  $k$ . Given any field  $k$ , show that there is a ring homomorphism  $\phi : \mathbb{Z} \rightarrow k$  which sends  $n > 0$  in  $\mathbb{Z}$  to  $1 \in k$  added to itself  $n$  times. If  $\phi$  is one-to-one, argue that  $k$  contains a copy of  $\mathbb{Q}$  and hence has characteristic 0.
  - If  $k$  does not have characteristic 0, it follows that the map  $\phi$  of part (b) cannot be one-to-one. Show that the kernel must be the ideal  $\langle p \rangle \subset \mathbb{Z}$  for some prime number  $p$ . We say that  $k$  has *characteristic*  $p$  in this case. Hint: Use the Isomorphism Theorem from Exercise 16 of Chapter 5, §2 and remember that  $k$  is an integral domain.
  - If  $k$  has characteristic  $p$ , show that  $(a + b)^p = a^p + b^p$  for every  $a, b \in k$ .
  - Suppose that  $k$  has characteristic  $p$  and let  $f \in k[x_1, \dots, x_n]$ . Show that all partial derivatives of  $f$  vanish identically if and only if every exponent of every monomial appearing in  $f$  is divisible by  $p$ .
  - Suppose that  $k$  is algebraically closed and has characteristic  $p$ . If  $f \in k[x_1, \dots, x_n]$  is irreducible, then show that some partial derivative of  $f$  must be nonzero. This shows that Theorem 8 is true for hypersurfaces over *any* algebraically closed field. Hint: If all partial derivatives vanish, use parts (d) and (e) to write  $f$  as a  $p$ -th power. Why do you need  $k$  to be algebraically closed?
11. Let  $V = V_1 \cup \dots \cup V_r$  be a decomposition of a variety into its irreducible components.
- Suppose that  $p \in V$  lies in a unique irreducible component  $V_i$ . Show that  $T_p(V) = T_p(V_i)$ . This reflects the local nature of the tangent space. Hint: One inclusion follows easily from  $V_i \subset V$ . For the other inclusion, pick a function  $f \in \mathbf{I}(W) - \mathbf{I}(V_i)$ , where  $W$  is the union of the other irreducible components. Then  $g \in \mathbf{I}(V_i)$  implies  $fg \in \mathbf{I}(V)$ .
  - With the same hypothesis as part (a), show that  $p$  is nonsingular in  $V$  if and only if it is nonsingular in  $V_i$ .
  - Let  $\Sigma$  be the singular locus of  $V$  and let  $\Sigma_i$  be the singular locus of  $V_i$ . Prove that

$$\Sigma = \bigcap_{i \neq j} (V_i \cap V_j) \cup \bigcup_i \Sigma_i.$$

Hint: Use part (b) and part (iv) of Theorem 8.

- If each  $\Sigma_i$  is a proper subset of  $V_i$ , then show that  $\Sigma$  contains no irreducible components of  $V$ . This shows that part (iii) of Theorem 8 follows from the irreducible case.
12. Find all singular points of the following curves in  $k^2$ . Assume that  $k$  is algebraically closed.
- $y^2 = x^3 - 3$ .
  - $y^2 = x^3 - 6x^2 + 9x$ .
  - $x^2y^2 + x^2 + y^2 + 2xy(x + y + 1) = 0$ .
  - $x^2 = x^4 + y^4$ .
  - $xy = x^6 + y^6$ .
  - $x^2y + xy^2 = x^4 + y^4$ .
  - $x^3 = y^2 + x^4 + y^4$ .
13. Find all singular points of the following surfaces in  $k^3$ . Assume that  $k$  is algebraically closed.
- $xy^2 = z^2$ .
  - $x^2 + y^2 = z^2$ .
  - $x^2y + x^3 + y^3 = 0$ .
  - $x^3 - zxy + y^3 = 0$ .
14. Show that  $\mathbf{V}(y - x^2 + z^2, 4x - y^2 + w^3) \subset \mathbb{C}^4$  is a nonempty smooth surface.

15. Let  $V \subset k^n$  be a hypersurface with  $\mathbf{I}(V) = \langle f \rangle$ . Show that if  $V$  is not a hyperplane and  $p \in V$  is nonsingular, then either the variety  $V \cap T_p(V)$  has a singular point at  $p$  or the restriction of  $f$  to  $T_p(V)$  has an irreducible factor of multiplicity  $\geq 2$ . Hint: Pick coordinates so that  $p = 0$  and  $T_p(V)$  is defined by  $x_1 = 0$ . Thus, we can regard  $T_p(V)$  as a copy of  $k^{n-1}$ , then  $V \cap T_p(V)$  is a hypersurface in  $k^{n-1}$ . Then the restriction of  $f$  to  $T_p(V)$  is the polynomial  $f(0, x_2, \dots, x_n)$ . See also Example 4.
16. Let  $V \subset \mathbb{C}^n$  be irreducible and let  $p \in V$  be a nonsingular point. Suppose that  $V$  has dimension  $d$ .
  - a. Show that we can find polynomials  $f_1, \dots, f_{n-d} \in \mathbf{I}(V)$  such that  $T_p(V) = V(d_p(f_1), \dots, d_p(f_{n-d}))$ .
  - b. If  $f_1, \dots, f_{n-d}$  are as in part (a) show that  $J_p(f_1, \dots, f_{n-d})$  has rank  $n - d$  and conclude that  $V$  is an irreducible component of  $V(f_1, \dots, f_{n-d})$ . This shows that although  $V$  itself may not be defined by  $n - d$  equations, it is a component of a variety that is. Hint: Use Theorem 9.
17. Suppose that  $V \subset \mathbb{C}^n$  is irreducible of dimension  $d$  and suppose that  $\mathbf{I}(V) = \langle f_1, \dots, f_s \rangle$ .
  - a. Show that  $p \in V$  is nonsingular if and only if  $J_p(f_1, \dots, f_s)$  has rank  $n - d$ . Hint: Use Proposition 2.
  - b. By Theorem 8, we know that  $V$  has nonsingular points. Use this and part (a) to prove that  $d \geq n - s$ . How does this relate to Proposition 5 of §4?
  - c. Let  $\mathcal{D}$  be the set of determinants of all  $(n - d) \times (n - d)$  submatrices of  $J(f_1, \dots, f_s)$ . Prove that the singular locus of  $V$  is  $\Sigma = V \cap \mathbf{V}(g : g \in \mathcal{D})$ . Hint: Use part (a) and Exercise 5. Also, what does part (ii) of Theorem 8 tell you about the rank of  $J_p(f_1, \dots, f_s)$ ?

## §7 The Tangent Cone

In this final section of the book, we will study the *tangent cone* of a variety  $V$  at a point  $p$ . When  $p$  is nonsingular, we know that, near  $p$ ,  $V$  is nicely approximated by its tangent space  $T_p(V)$ . This clearly fails when  $p$  is singular, for as we saw in Theorem 8 of §6, the tangent space has the wrong dimension (it is too big). To approximate  $V$  near a singular point, we need something different.

We begin with an example.

**Example 1.** Consider the curve  $y^2 = x^2(x + 1)$ , which has the following picture in the plane  $\mathbb{R}^2$ :

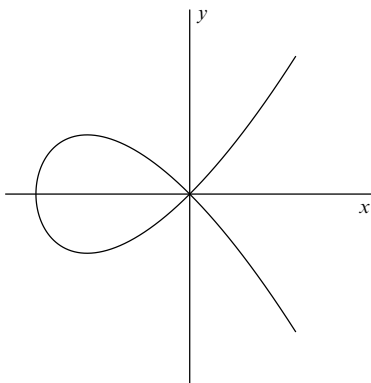



We see that the origin is a singular point. Near this point, the curve is approximated by the lines  $x = \pm y$ . These lines are defined by  $x^2 - y^2 = 0$ , and if we write the defining equation of the curve as  $f(x, y) = x^2 - y^2 + x^3 = 0$ , we see that  $x^2 - y^2$  is the nonzero homogeneous component of  $f$  of smallest total degree.

Similarly, consider the curve  $y^2 - x^3 = 0$ :

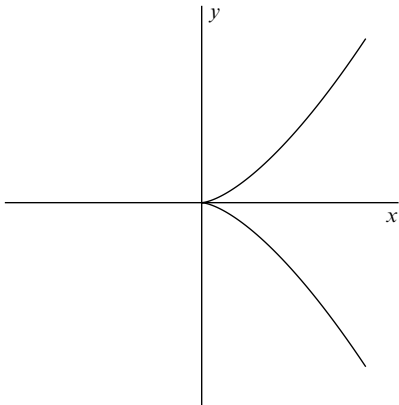

The origin is again a singular point, and the nonzero homogeneous component of  $y^2 - x^3$  of smallest total degree is  $y^2$ . Here,  $V(y^2)$  is the  $x$ -axis and gives a nice approximation of the curve near  $(0, 0)$ .

In both of the above curves, we approximated the curve near the singular point using the smallest nonzero homogeneous component of the defining equation. To generalize this idea, suppose that  $p = (p_1, \dots, p_n) \in k^n$ . If  $\alpha = (\alpha_1, \dots, \alpha_n) \in \mathbb{Z}_{\geq 0}^n$  let

$$(x - p)^\alpha = (x_1 - p_1)^{\alpha_1} \cdots (x_n - p_n)^{\alpha_n}$$

and note that  $(x - p)^\alpha$  has total degree  $|\alpha| = \alpha_1 + \dots + \alpha_n$ . Now, given any polynomial  $f \in k[x_1, \dots, x_n]$  of total degree  $d$ , we can write  $f$  as a polynomial in  $x_i - p_i$ , so that  $f$  is a  $k$ -linear combination of  $(x - p)^\alpha$  for  $|\alpha| \leq d$ . If we group according to total degree, we can write

$$(1) \quad f = f_{p,0} + f_{p,1} + \cdots + f_{p,d},$$

where  $f_{p,j}$  is a  $k$ -linear combination of  $(x - p)^\alpha$  for  $|\alpha| = j$ . Note that  $f_{p,0} = f(p)$  and  $f_{p,1} = d_p(f)$  (as defined in Definition 1 of the previous section). In the exercises, you will discuss Taylor’s formula, which shows how to express  $f_{p,j}$  in terms of the partial derivatives of  $f$  at  $p$ . In many situations, it is convenient to translate  $p$  to the origin so that we can use homogeneous components. We can now define the tangent cone.

**Definition 2.** Let  $V \subset k^n$  be an affine variety and let  $p = (p_1, \dots, p_n) \in V$ .

- (i) If  $f \in k[x_1, \dots, x_n]$  is a nonzero polynomial, then  $f_{p,min}$  is defined to be  $f_{p,j}$ , where  $j$  is the smallest integer such that  $f_{p,j} \neq 0$  in (1).

(ii) The **tangent cone** of  $V$  at  $p$ , denoted  $C_p(V)$ , is the variety

$$C_p(V) = \mathbf{V}(f_{p,min} : f \in \mathbf{I}(V)).$$

The tangent cone gets its name from the following proposition.

**Proposition 3.** *Let  $p \in V \subset k^n$ . Then  $C_p(V)$  is the translate of the affine cone of a variety in  $\mathbb{P}^{n-1}(k)$ .*

**Proof.** Introduce new coordinates on  $k^n$  by letting  $X_i = x_i - p_i$ . Relative to this coordinate system, we can assume that  $p$  is the origin 0. Then  $f_{0,min}$  is a homogeneous polynomial in  $X_1, \dots, X_n$ , and as  $f$  varies over  $\mathbf{I}(V)$ , the  $f_{0,min}$  generate a homogeneous ideal  $J \subset k[X_1, \dots, X_n]$ . Then  $C_p(V) = \mathbf{V}_a(J) \subset k^n$  by definition. Since  $J$  is homogeneous, we also get a projective variety  $W = \mathbf{V}_p(J) \subset \mathbb{P}^{n-1}(k)$ , and as we saw in Chapter 8, this means that  $C_p(V)$  is an affine cone  $C_W \subset k^n$  of  $W$ . This proves the proposition.  $\square$

The tangent cone of a hypersurface  $V \subset k^n$  is especially easy to compute. In Exercise 2 you will show that if  $\mathbf{I}(V) = \langle f \rangle$ , then  $C_p(V)$  is defined by the single equation  $f_{p,min} = 0$ . This is exactly what we did in Example 1. However, when  $\mathbf{I}(V) = \langle f_1, \dots, f_s \rangle$  has more generators, it need *not* follow that  $C_p(V) = \mathbf{V}((f_1)_{p,min}, \dots, (f_s)_{p,min})$ . For example, suppose that  $V$  is defined by  $xy = xz + z(y^2 - z^2) = 0$ . In Exercise 3, you will show that  $\mathbf{I}(V) = \langle xy, xz + z(y^2 - z^2) \rangle$ . To see that  $C_0(V) \neq \mathbf{V}(xy, xz)$ , note that  $f = yz(y^2 - z^2) = y(xz + z(y^2 - z^2)) - z(xy) \in \mathbf{I}(V)$ . Then  $f_{0,min} = yz(y^2 - z^2)$  vanishes on  $C_0(V)$ , yet does not vanish on all of  $\mathbf{V}(xy, xz)$ .

We can overcome this difficulty by using an appropriate Groebner basis. The result is stated most efficiently when the point  $p$  is the origin.

**Proposition 4.** *Assume that the origin 0 is a point of  $V \subset k^n$ . Let  $x_0$  be a new variable and pick a monomial order on  $k[x_0, x_1, \dots, x_n]$  such that among monomials of the same total degree, any monomial involving  $x_0$  is greater than any monomial involving only  $x_1, \dots, x_n$  (lex and grlex with  $x_0 > \dots > x_n$  satisfy this condition).*

(i) *Let  $\mathbf{I}(V)^h \subset k[x_0, x_1, \dots, x_n]$  be the homogenization of  $\mathbf{I}(V)$  and let  $G_1, \dots, G_s$  be a Groebner basis of  $\mathbf{I}(V)^h$  with respect to the above monomial order. Then*

$$C_0(V) = \mathbf{V}((g_1)_{0,min}, \dots, (g_s)_{0,min}),$$

where  $g_i = G_i(1, x_1, \dots, x_n)$  is the dehomogenization of  $G_i$ .

(ii) *Suppose that  $k$  is algebraically closed, and let  $I$  be any ideal such that  $V = \mathbf{V}(I)$ . If  $G_1, \dots, G_s$  are a Groebner basis of  $I^h$ , then*

$$C_0(V) = \mathbf{V}((g_1)_{0,min}, \dots, (g_s)_{0,min}),$$

where  $g_i = G_i(1, x_1, \dots, x_n)$  is the dehomogenization of  $G_i$ .

**Proof.** In this proof, we will write  $f_j$  and  $f_{min}$  rather than  $f_{0,j}$  and  $f_{0,min}$ .

- (i) Let  $I = \mathbf{I}(V)$ . It suffices to show that  $f_{min} \in \langle (g_1)_{min}, \dots, (g_s)_{min} \rangle$  for all  $f \in I$ . If this fails to hold, then we can find  $f \in I$  with  $f_{min} \notin \langle (g_1)_{min}, \dots, (g_s)_{min} \rangle$  such that  $\text{LT}(f_{min})$  is minimal [note that we can regard  $f_{min}$  as a polynomial in  $k[x_0, x_1, \dots, x_n]$ , so that  $\text{LT}(f_{min})$  is defined]. If we write  $f$  as a sum of homogeneous components

$$f = f_{min} + \dots + f_d,$$

where  $d$  is the total degree of  $f$ , then

$$f^h = f_{min}x_0^a + \dots + f_d \in I^h$$

for some  $a$ . By the way we chose the monomial order on  $k[x_0, x_1, \dots, x_n]$ , it follows that  $\text{LT}(f^h) = \text{LT}(f_{min})x_0^a$ . Since  $G_1, \dots, G_s$  form a Groebner basis, we know that some  $\text{LT}(G_i)$  divides  $\text{LT}(f_{min})x_0^a$ .

If  $g_i$  is the dehomogenization of  $G_i$ , it is easy to see that  $g_i \in I$ . We leave it as an exercise to show that

$$\text{LT}(G_i) = \text{LT}((g_i)_{min})x_0^b$$

for some  $b$ . This implies that  $\text{LT}(f_{min}) = cx^\alpha \text{LT}((g_i)_{min})$  for some nonzero  $c \in k$  and some monomial  $x^\alpha$  in  $x_1, \dots, x_n$ . Now consider  $\tilde{f} = f - cx^\alpha g_i \in I$ . Since  $f_{min} \notin \langle (g_1)_{min}, \dots, (g_s)_{min} \rangle$ , we know that  $f_{min} - cx^\alpha (g_i)_{min} \neq 0$ , and it follows easily that

$$\tilde{f}_{min} = f_{min} - cx^\alpha (g_i)_{min}.$$

Then  $\text{LT}(\tilde{f}_{min}) < \text{LT}(f_{min})$  since the leading terms of  $f_{min}$  and  $cx^\alpha (g_i)_{min}$  are equal. This contradicts the minimality of  $\text{LT}(f_{min})$ , and (i) is proved. In the exercises, you will show that  $g_1, \dots, g_n$  are a basis of  $I$ , though not necessarily a Groebner basis.

- (ii) Let  $W$  denote the variety  $\mathbf{V}(f_{min} : f \in I)$ . If we apply the argument of part (i) to the ideal  $I$ , we see immediately that

$$W = \mathbf{V}((g_1)_{min}, \dots, (g_s)_{min}).$$

It remains to show that  $W$  is the tangent cone at the origin. Since  $I \subset \mathbf{I}(V)$ , the inclusion  $C_0(V) \subset W$  is obvious by the definition of tangent cone. Going the other way, suppose that  $g \in \mathbf{I}(V)$ . We need to show that  $g_{min}$  vanishes on  $W$ . By the Nullstellensatz, we know that  $g^m \in I$  for some  $m$  and, hence,  $(g^m)_{min} = 0$  on  $W$ . In the exercises, you will check that  $(g^m)_{min} = (g_{min})^m$  and it follows that  $g_{min}$  vanishes on  $W$ . This completes the proof of the proposition. □

In practice, this proposition is usually used over an algebraically closed field, for here, part (ii) says that we can compute the tangent cone using *any* set of defining equations of the variety.

For an example of how to use Proposition 4, suppose  $V = \mathbf{V}(xy, xz + z(y^2 - z^2))$ . If we set  $I = \langle xy, xz + z(y^2 - z^2) \rangle$ , the first step is to determine  $I^h \subset k[w, x, y, z]$ , where  $w$  is the homogenizing variable. Using grlex order on  $k[x, y, z]$ , a Groebner basis for  $I$  is  $\{xy, xz + z(y^2 - z^2), x^2z - xz^3\}$ . By the theory developed in §4 of Chapter 8,

$\{xy, xzw + z(y^2 - z^2), x^2zw - xz^3\}$  is a basis of  $I^h$ . In fact, it is a Groebner basis for grlex order, with the variables ordered  $x > y > z > w$  (see Exercise 5). However, this monomial order does not satisfy the hypothesis of Proposition 4, but if we use grlex with  $w > x > y > z$ , then a Groebner basis is

$$\{xy, xzw + z(y^2 - z^2), yz(y^2 - z^2)\}.$$

Proposition 4 shows that if we dehomogenize and take minimal homogeneous components, then the tangent cone at the origin is given by

$$C_0(V) = \mathbf{V}(xy, xz, yz(y^2 - z^2)).$$

In the exercises, you will show that this is a union of five lines through the origin in  $k^3$ .

We will next study how the tangent cone approximates the variety  $V$  near the point  $p$ . Recall from Proposition 3 that  $C_p(V)$  is the translate of an affine cone, which means that  $C_p(V)$  is made up of lines through  $p$ . So to understand the tangent cone, we need to describe which lines through  $p$  lie in  $C_p(V)$ . We will do this using secant lines. More precisely, let  $L$  be a line in  $k^n$  through  $p$ . Then  $L$  is a *secant line* of  $V$  if it meets  $V$  in a point distinct from  $p$ . Here is the crucial idea: if we take secant lines determined by points of  $V$  getting closer and closer to  $p$ , then the “limit” of the secant lines should lie on the tangent cone. You can see this in the following picture.

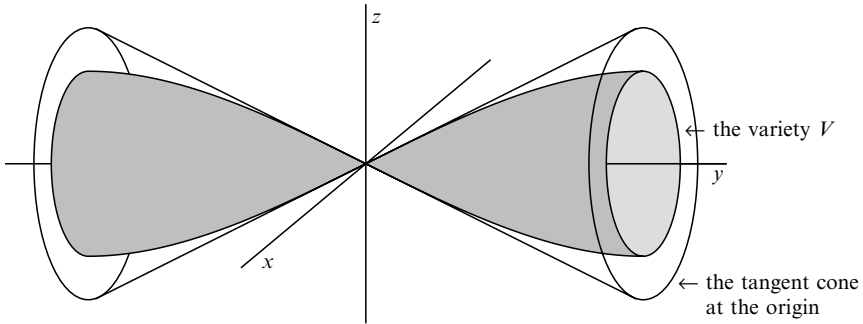

To make this idea precise, we will work over the complex numbers  $\mathbb{C}$ . Here, it is possible to define what it means for a sequence of points  $q_k \in \mathbb{C}^n$  to converge to  $q \in \mathbb{C}^n$ . For instance, if we think of  $\mathbb{C}^n$  as  $\mathbb{R}^{2n}$ , this means that the coordinates of  $q_k$  converge to the coordinates of  $q$ . We will assume that the reader has had some experience with sequences of this sort.

We will treat lines through their parametrizations. So suppose we have parametrized  $L$  via  $p + tv$ , where  $v \in \mathbb{C}^n$  is a nonzero vector parallel to  $L$  and  $t \in \mathbb{C}$ . Then we define a limit of lines as follows.

**Definition 5.** We say that a line  $L \subset \mathbb{C}^n$  through a point  $p \in \mathbb{C}^n$  is a **limit of lines**  $\{L_k\}_{k=1}^\infty$  through  $p$  if given a parametrization  $p + tv$  of  $L$ , there exist parametrizations  $p + tv_k$  of  $L_k$  such that  $\lim_{k \rightarrow \infty} v_k = v$  in  $\mathbb{C}^n$ .

This notion of convergence corresponds to the following picture:

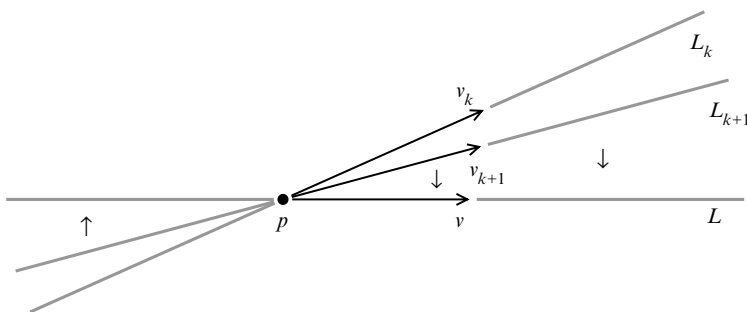

Now we can state a precise version of how the tangent cone approximates a complex variety near a point.

**Theorem 6.** *Let  $V \subset \mathbb{C}^n$  be an affine variety. Then a line  $L$  through  $p \in V$  lies in the tangent cone  $C_p(V)$  if and only if there exists a sequence  $\{q_k\}_{k=1}^\infty$  of points in  $V - \{p\}$  converging to  $p$  such that if  $L_k$  is the secant line containing  $p$  and  $q_k$ , then the lines  $L_k$  converge to the given line  $L$ .*

**Proof.** By translating  $p$  to the origin, we may assume that  $p = 0$ . Let  $\{q_k\}$  be a sequence of points on  $V$  converging to the origin and suppose the lines  $L_k$  through 0 and  $q_k$  converge (in the sense of Definition 5) to some line  $L$  through the origin. We want to show that  $L \subset C_0(V)$ .

By the definition of  $L_k$  converging to  $L$ , we can find parametrizations  $tv_k$  of  $L_k$  (remember that  $p = 0$ ) such that the  $v_k$  converge to  $v$  as  $k \rightarrow \infty$ . Since  $q_k \in L_k$ , we can write  $q_k = t_k v_k$  for some complex number  $t_k$ . Note that  $t_k \neq 0$  since  $q_k \neq p$ . We claim that the  $t_k$  converge to 0. This follows because as  $k \rightarrow \infty$ , we have  $v_k \rightarrow v \neq 0$  and  $t_k v_k = q_k \rightarrow 0$ . (A more detailed argument will be given in Exercise 8.)

Now suppose that  $f$  is any polynomial that vanishes on  $V$ . As in the proof of Proposition 4, we write  $f_{min}$  and  $f_j$  rather than  $f_{0,min}$  and  $f_{0,j}$ . If  $f$  has total degree  $d$ , then we can write  $f = f_l + f_{l+1} + \dots + f_d$ , where  $f_l = f_{min}$ . Since  $q_k = t_k v_k \in V$ , we have

$$(2) \quad 0 = f(t_k v_k) = f_l(t_k v_k) + \dots + f_d(t_k v_k).$$

Each  $f_i$  is homogeneous of degree  $i$ , so that  $f_i(t_k v_k) = t_k^i f_i(v_k)$ . Thus,

$$(3) \quad 0 = t_k^l f_l(v_k) + \dots + t_k^d f_d(v_k).$$

Since  $t_k \neq 0$ , we can divide through by  $t_k^l$  to obtain

$$(4) \quad 0 = f_l(v_k) + t_k f_{l+1}(v_k) + \dots + t_k^{d-l} f_d(v_k).$$

Letting  $k \rightarrow \infty$ , the right-hand side in (4) tends to  $f_l(v)$  since  $v_k \rightarrow v$  and  $t_k \rightarrow 0$ . We conclude that  $f_l(v) = 0$ , and since  $f_l(tv) = t^l f_l(v) = 0$  for all  $t$ , it follows that  $L \subset C_0(V)$ . This shows that  $C_0(V)$  contains all limits of secant lines determined by sequences of points in  $V$  converging to 0.

To prove the converse, we will first study the set

$$(5) \quad \mathcal{V} = \{(v, t) \in \mathbb{C}^n \times \mathbb{C} : tv \in V, t \neq 0\} \subset \mathbb{C}^{n+1}.$$

If  $(v, t) \in \mathcal{V}$ , note that the  $L$  determined by 0 and  $tv \in V$  is a secant line. Thus, we want to know what happens to  $\mathcal{V}$  as  $t \rightarrow 0$ . For this purpose, we will study the Zariski closure  $\overline{\mathcal{V}}$  of  $\mathcal{V}$ , which is the smallest variety in  $\mathbb{C}^{n+1}$  containing  $\mathcal{V}$ . We claim that

$$(6) \quad \overline{\mathcal{V}} = \mathcal{V} \cup (C_0(V) \times \{0\}).$$

From §4 of Chapter 4, we know that  $\overline{\mathcal{V}} = \mathbf{V}(\mathbf{I}(\mathcal{V}))$ . So we need to calculate the functions that vanish on  $\mathcal{V}$ . If  $f \in \mathbf{I}(V)$ , write  $f = f_l + \dots + f_d$  where  $f_l = f_{min}$ , and set

$$\tilde{f} = f_l + tf_{l+1} + \dots + t^{d-l} f_d \in \mathbb{C}[t, x_1, \dots, x_n].$$

We will show that

$$(7) \quad \mathbf{I}(\mathcal{V}) = \langle \tilde{f} : f \in \mathbf{I}(V) \rangle.$$

One direction of the proof is easy, for  $f \in \mathbf{I}(V)$  and  $(v, t) \in \mathcal{V}$  imply  $f(tv) = 0$ , and then equations (2), (3), and (4) show that  $\tilde{f}(v, t) = 0$ . Conversely, suppose that  $g \in \mathbb{C}[t, x_1, \dots, x_n]$  vanishes on  $\mathcal{V}$ . Write  $g = \sum_i g_i t^i$ , where  $g_i \in \mathbb{C}[x_1, \dots, x_n]$ , and let  $g_i = \sum_j g_{ij}$  be the decomposition of  $g_i$  into the sum of its homogeneous components. If  $(v, t) \in \mathcal{V}$ , then for every  $\lambda \in \mathbb{C} - \{0\}$ , we have  $(\lambda v, \lambda^{-1}t) \in \mathcal{V}$  since  $(\lambda^{-1}t) \cdot (\lambda v) = tv \in V$ . Thus,

$$0 = g(\lambda v, \lambda^{-1}t) = \sum_{i,j} g_{ij}(\lambda v)(\lambda^{-1}t)^i = \sum_{i,j} \lambda^j g_{ij}(v)\lambda^{-i}t^i = \sum_{i,j} \lambda^{j-i} g_{ij}(v)t^i$$

for all  $\lambda \neq 0$ . Letting  $m = j - i$ , we can organize this sum according to powers of  $\lambda$ :

$$0 = \sum_m \left( \sum_i g_{i,m+i}(v)t^i \right) \lambda^m.$$

Since this holds for all  $\lambda \neq 0$ , it follows that  $\sum_i g_{i,m+i}(v)t^i = 0$  for all  $m$  and, hence,  $\sum_i g_{i,m+i}t^i \in \mathbf{I}(\mathcal{V})$ . Let  $f_m = \sum_i g_{i,m+i} \in \mathbb{C}[x_1, \dots, x_n]$ . Since  $(v, 1) \in \mathcal{V}$  for all  $v \in V$ , it follows that  $f_m \in \mathbf{I}(V)$ . If we let  $i_0$  be the smallest  $i$  such that  $g_{i,m+i} \neq 0$ , then

$$\tilde{f}_m = g_{i_0,m+i_0} + g_{i_0+1,m+i_0+1}t + \dots,$$

so that  $\sum_i g_{i,m+i}t^i = t^{i_0} \tilde{f}_m$ . From this, it follows immediately that  $g \in \langle \tilde{f} : f \in \mathbf{I}(V) \rangle$ , and (7) is proved.

From (7), we have  $\overline{\mathcal{V}} = \mathbf{V}(\tilde{f} : f \in \mathbf{I}(V))$ . To compute this variety, let  $(v, t) \in \mathbb{C}^{n+1}$ , and first suppose that  $t \neq 0$ . Using (2), (3), and (4), it follows easily that  $\tilde{f}(v, t) = 0$  if

and only if  $f(tv) = 0$ . Thus,

$$\overline{\mathcal{V}} \cap \{(v, t) : t \neq 0\} = \mathcal{V}.$$

Now suppose  $t = 0$ . If  $f = f_{\min} + \cdots + f_d$ , it follows from the definition of  $\tilde{f}$  that  $\tilde{f}(v, 0) = 0$  if and only if  $f_{\min}(v) = 0$ . Hence,

$$\overline{\mathcal{V}} \cap \{(v, t) : t = 0\} = C_0(V) \times \{0\},$$

and (6) is proved.

To complete the proof of Theorem 6, we will need the following fact about Zariski closure.

**Proposition 7.** *Let  $Z \subset W \subset \mathbb{C}^n$  be affine varieties and assume that  $W$  is the Zariski closure of  $W - Z$ . If  $z \in Z$  is any point, then there is a sequence of points  $\{w_k \in W - Z\}_{k=1}^{\infty}$  which converges to  $z$ .*

**Proof.** The proof of this is beyond the scope of the book. In Theorem (2.33) of MUMFORD (1976), this result is proved for irreducible varieties in  $\mathbb{P}^n(\mathbb{C})$ . Exercise 9 will show how to deduce Proposition 7 from Mumford's theorem.  $\square$

To apply this proposition to our situation, let  $Z = C_0(V) \times \{0\} \subset W = \overline{\mathcal{V}}$ . By (6), we see that  $W - Z = \overline{\mathcal{V}} - C_0(V) \times \{0\} = \mathcal{V}$  and, hence,  $W = \overline{\mathcal{V}}$  is the Zariski closure of  $W - Z$ . Then the proposition implies that any point in  $Z = C_0(V) \times \{0\}$  is a limit of points in  $W - Z = \mathcal{V}$ .

We can now finish the proof of Theorem 6. Suppose a line  $L$  parametrized by  $tv$  is contained in  $C_0(V)$ . Then  $v \in C_0(V)$ , which implies that  $(v, 0) \in C_0(V) \times \{0\}$ . By the above paragraph, we can find points  $(v_k, t_k) \in \mathcal{V}$  which converge to  $(v, 0)$ . If we let  $L_k$  be the line parametrized by  $tv_k$ , then  $v_k \rightarrow v$  shows that  $L_k \rightarrow L$ . Furthermore, since  $q_k = t_k v_k \in V$  and  $t_k \neq 0$ , we see that  $L_k$  is the secant line determined by  $q_k \in V$ . Finally, as  $k \rightarrow \infty$ , we have  $q_k = t_k \cdot v_k \rightarrow 0 \cdot v = 0$ , which shows that  $L$  is a limit of secant lines of points  $q_k \in V$  converging to 0. This completes the proof of the theorem.  $\square$

If we are working over an infinite field  $k$ , we may not be able to define what it means for secant lines to converge to a line in the tangent cone. So it is not clear what the analogue of Theorem 6 should be. But if  $p = 0$  is in  $V$  over  $k$ , we can still form the set  $\mathcal{V}$  as in (5), and every secant line still gives a point  $(v, t) \in \mathcal{V}$  with  $t \neq 0$ . A purely algebraic way to discuss limits of secant lines as  $t \rightarrow 0$  would be to take the smallest variety containing  $\mathcal{V}$  and see what happens when  $t = 0$ . This means looking at  $\overline{\mathcal{V}} \cap (k^n \times \{0\})$ , which by (6) is exactly  $C_0(V) \times \{0\}$ . You should check that the proof of (6) is valid over  $k$ , so that the decomposition

$$\overline{\mathcal{V}} = \mathcal{V} \cup (C_0(V) \times \{0\})$$

can be regarded as the extension of Theorem 6 to the infinite field  $k$ . In Exercise 10, we will explore some other interesting aspects of the variety  $\overline{\mathcal{V}}$ .

Another way in which the tangent cone approximates the variety is in terms of dimension. Recall from §6 that  $\dim_p V$  is the maximum dimension of an irreducible component of  $V$  containing  $p$ .

**Theorem 8.** *Let  $p$  be a point on an affine variety  $V \subset k^n$ . Then  $\dim_p V = \dim C_p(V)$ .*

**Proof.** This is a standard result in advanced courses in commutative algebra [see, for example, Theorem 13.9 in MATSUMURA (1986)]. As in §6, we will only prove this for the case of a hypersurface in  $\mathbb{C}^n$ . If  $V = \mathbf{V}(f)$ , we know that  $C_p(V) = \mathbf{V}(f_{p,min})$  by Exercise 2. Thus, both  $V$  and  $C_p(V)$  are hypersurfaces, and, hence, both have dimension  $n - 1$  at all points. This shows that  $\dim_p V = \dim C_p(V)$ .  $\square$

This is a nice result because it enables us to compute  $\dim_p V$  without having to decompose  $V$  into its irreducible components.

The final topic of this section will be the relation between the tangent cone and the tangent space. In the exercises, you will show that for any point  $p$  of a variety  $V$ , we have

$$C_p(V) \subset T_p(V).$$

In terms of dimensions, this implies that

$$\dim C_p(V) \leq \dim T_p(V).$$

Then the following corollary of Theorem 8 tells us when these coincide.

**Corollary 9.** *Assume that  $k$  is algebraically closed and let  $p$  be a point of a variety  $V \subset k^n$ . Then the following are equivalent:*

- (i)  $p$  is a nonsingular point of  $V$ .
- (ii)  $\dim C_p(V) = \dim T_p(V)$ .
- (iii)  $C_p(V) = T_p(V)$ .

**Proof.** Since  $\dim C_p(V) = \dim_p V$  by Theorem 8, the equivalence of (i) and (ii) is immediate from the definition of a nonsingular point. The implication (iii)  $\Rightarrow$  (ii) is trivial, so that it remains to prove (ii)  $\Rightarrow$  (iii).

Since  $k$  is algebraically closed, we know that  $k$  is infinite, which implies that the linear space  $T_p(V)$  is an irreducible variety in  $k^n$ . [When  $T_p(V)$  is a coordinate subspace, this follows from Exercise 7 of §1. See Exercise 12 below for the general case.] Thus, if  $C_p(V)$  has the same dimension  $\dim T_p(V)$ , the equality  $C_p(V) = T_p(V)$  follows immediately from the affine version of Proposition 10 of §4 (see Exercise 18 of §4).  $\square$

If we combine Theorem 6 and Corollary 9, it follows that at a nonsingular point  $p$  of a variety  $V \subset \mathbb{C}^n$ , the tangent space at  $p$  is the union of all limits of secant lines determined by sequences of points in  $V$  converging to  $p$ . This is a powerful



generalization of the idea from elementary calculus that the tangent line to a curve is a limit of secant lines.

### EXERCISES FOR §7

1. Suppose that  $k$  is a field of characteristic 0. Given  $p \in k^n$  and  $f \in k[x_1, \dots, x_n]$ , we know that  $f$  can be written in the form  $f = \sum_{\alpha} c_{\alpha} (x - p)^{\alpha}$ , where  $c_{\alpha} \in k$  and  $(x - p)^{\alpha}$  is as in the text. Given  $\alpha$ , define

$$\frac{\partial^{\alpha}}{\partial x^{\alpha}} = \frac{\partial^{\alpha_1}}{\partial x_1^{\alpha_1}} \cdots \frac{\partial^{\alpha_n}}{\partial x_n^{\alpha_n}},$$

where  $\frac{\partial^{\alpha_i}}{\partial x_i^{\alpha_i}}$  means differentiation  $\alpha_i$  times with respect to  $x_i$ . Finally, set

$$\alpha! = \alpha_1! \cdot \alpha_2! \cdots \alpha_n!$$

- a. Show that

$$\frac{\partial^{\alpha} (x - p)^{\beta}}{\partial x^{\alpha}} (p) = \begin{cases} \alpha! & \text{if } \alpha = \beta \\ 0 & \text{otherwise.} \end{cases}$$

Hint: There are two cases to consider: when  $\beta_i < \alpha_i$ , for some  $i$  and when  $\beta_i \geq \alpha_i$  for all  $i$ .

- b. If  $f = \sum_{\alpha} c_{\alpha} (x - p)^{\alpha}$ , then show that

$$c_{\alpha} = \frac{1}{\alpha!} \frac{\partial^{\alpha} f}{\partial x^{\alpha}} (p),$$

and conclude that

$$f = \sum_{\alpha} \frac{1}{\alpha!} \frac{\partial^{\alpha} f}{\partial x^{\alpha}} (p) (x - p)^{\alpha}.$$

This is *Taylor's formula* for  $f$  at  $p$ . Hint: Be sure to explain where you use the characteristic 0 assumption.

- c. Write out the formula of part (b) explicitly when  $f \in k[x, y]$  has total degree 3.  
 d. What formula do we get for  $f_{p,j}$  in terms of the partial derivatives of  $f$ ?  
 e. Give an example to show that over a finite field, it may be impossible to express  $f$  in terms of its partial derivatives. Hint: See Exercise 10 of §6.
2. Let  $V \subset k^n$  be a hypersurface.
- If  $\mathbf{I}(V) = \langle f \rangle$ , prove that  $C_p(V) = \mathbf{V}(f_{p,min})$ .
  - If  $k$  is algebraically closed and  $V = \mathbf{V}(f)$ , prove that the conclusion of part (a) is still true. Hint: See the proof of part (ii) of Proposition 4.
3. In this exercise, we will show that the ideal  $I = \langle xy, xz + z(y^2 - z^2) \rangle \subset k[x, y, z]$  is a radical ideal when  $k$  has characteristic 0.
- Show that

$$\langle x, z(y^2 - z^2) \rangle = \langle x, z \rangle \cap \langle x, y - z \rangle \cap \langle x, y + z \rangle.$$

Furthermore, show that the three ideals on the right-hand side of the equation are prime. Hint: Work in  $k[x, y, z]/\langle x \rangle \cong k[y, z]$  and use the fact that  $k[y, z]$  has unique factorization. Also explain why this result fails if  $k$  is the field  $\mathbb{F}_2$  consisting of two elements.

- Show that

$$\langle y, xz - z^3 \rangle = \langle y, z \rangle \cap \langle y, x - z^2 \rangle,$$

and show that the two ideals on the right-hand side of the equation are prime.

- c. Prove that  $I = \langle x, z(y^2 - z^2) \rangle \cap \langle y, xz - z^3 \rangle$ . Hint: One way is to use the ideal intersection algorithm from Chapter 4, §3. There is also an elementary argument.
- d. By parts (a), (b) and (c) we see that  $I$  is an intersection of five prime ideals. Show that  $I$  is a radical ideal. Also, use this decomposition of  $I$  to describe  $V = \mathbf{V}(I) \subset k^3$ .
- e. If  $k$  is algebraically closed, what is  $\mathbf{I}(V)$ ?
4. This exercise is concerned with the proof of Proposition 4. Fix a monomial order  $>$  on  $k[x_0, \dots, x_n]$  with the properties described in the statement of the proposition.
- If  $g \in k[x_1, \dots, x_n]$  is the dehomogenization of  $G \in k[x_0, \dots, x_n]$ , prove that  $\text{LT}(G) = \text{LT}(g_{\min})x_0^b$  for some  $b$ .
  - If  $G_1, \dots, G_s$  is a basis of  $I^h$ , prove that the dehomogenizations  $g_1, \dots, g_s$  form a basis of  $I$ . In Exercise 5, you will show that if the  $G_i$ 's are a Groebner basis for  $>$ , the  $g_i$ 's may fail to be a Groebner basis for  $I$  with respect to the monomial induced order on  $k[x_1, \dots, x_n]$ .
  - If  $f, g \in k[x_1, \dots, x_n]$ , show that  $(f \cdot g)_{\min} = f_{\min} \cdot g_{\min}$ . Conclude that  $(f^m)_{\min} = (f_{\min})^m$ .
5. We will continue our study of the variety  $V = \mathbf{V}(xy, xz + z(y^2 - z^2))$  begun in the text.
- If we use grlex with  $w > x > y > z$ , show that a Groebner basis for  $I^h \subset k[w, x, y, z]$  is  $\{xy, xzw + z(y^2 - z^2), yz(y^2 - z^2)\}$ .
  - If we dehomogenize the Groebner basis of part (a), we get a basis of  $I$ . Show that this basis is *not* a Groebner basis of  $I$  for grlex with  $x > y > z$ .
  - Use Proposition 4 to show that the tangent cone  $C_0(V)$  is a union of five lines through the origin in  $k^3$  and compare your answer to part (e) of Exercise 3.
6. Compute the dimensions of the tangent cone and the tangent space at the origin of the varieties defined by the following ideals:
- $\langle xz, xy \rangle \subset k[x, y, z]$ .
  - $\langle x - y^2, x - z^3 \rangle \subset k[x, y, z]$ .
7. In §3 of Chapter 3, we used elimination theory to show that the tangent surface of the twisted cubic  $\mathbf{V}(y - x^2, z - x^3) \subset \mathbb{R}^3$  is defined by the equation

$$x^3z - (3/4)x^2y^2 - (3/2)xyz + y^3 + (1/4)z^2 = 0.$$

- Show that the singular locus of the tangent surface  $S$  is exactly the twisted cubic. Hint: Two different ideals may define the same variety. For an example of how to deal with this, see equation (14) in Chapter 3, §4.
  - Compute the tangent space and tangent cone of the surface  $S$  at the origin.
8. Suppose that in  $\mathbb{C}^n$  we have two sequences of vectors  $v_k$  and  $t_k v_k$ , where  $t_k \in \mathbb{C}$ , such that  $v_k \rightarrow v \neq 0$  and  $t_k v_k \rightarrow 0$ . We claim that  $t_k \rightarrow 0$  in  $\mathbb{C}$ . To prove this, define the length of a complex number  $t = x + iy$  to be  $|t| = \sqrt{x^2 + y^2}$  and define the length of  $v = (z_1, \dots, z_n) \in \mathbb{C}^n$  to be  $|v| = \sqrt{|z_1|^2 + \dots + |z_n|^2}$ . Recall that  $v_k \rightarrow v$  means that for every  $\epsilon > 0$ , there is  $N$  such that  $|v_k - v| < \epsilon$  for  $k \geq N$ .
- If we write  $v = (z_1, \dots, z_n)$  and  $v_k = (z_{k1}, \dots, z_{kn})$ , then show that  $v_k \rightarrow v$  implies  $z_{kj} \rightarrow z_j$  for all  $j$ . Hint: Observe that  $|z_j| \leq |v|$ .
  - Pick a nonzero component  $z_j$  of  $v$ . Show that  $z_{kj} \rightarrow z_j \neq 0$  and  $t_k z_{kj} \rightarrow 0$ . Then divide by  $z_j$  and conclude that  $t_k \rightarrow 0$ .
9. Theorem (2.33) of MUMFORD (1976) states that if  $W \subset \mathbb{P}^n(\mathbb{C})$  is an irreducible projective variety and  $Z \subset W$  is a projective variety not equal to  $W$ , then any point in  $Z$  is a limit of points in  $W - Z$ . Our goal is to apply this to prove Proposition 7.
- Let  $Z \subset W \subset \mathbb{C}^n$  be affine varieties such that  $W$  is the Zariski closure of  $W - Z$ . Show that  $Z$  contains no irreducible component of  $W$ .

- b. Show that it suffices to prove Proposition 7 in the case when  $W$  is irreducible. Hint: If  $p$  lies in  $Z$ , then it lies in some component  $W_1$  of  $W$ . What does part (a) tell you about  $W_1 \cap Z \subset W_1$ ?
  - c. Let  $Z \subset W \subset \mathbb{C}^n$ , where  $W$  is irreducible and  $Z \neq W$ , and let  $\bar{Z}$  and  $\bar{W}$  be their projective closures in  $\mathbb{P}^n(\mathbb{C})$ . Show that the irreducible case of Proposition 7 follows from Mumford's Theorem (2.33). Hint: Use  $\bar{Z} \cup (\bar{W} - W) \subset \bar{W}$ .
  - d. Show that the converse of the proposition is true in the following sense. Let  $p \in \mathbb{C}^n$ . If  $p \notin V - W$  and  $p$  is a limit of points in  $V - W$ , then show that  $p \in W$ . Hint: Show that  $p \in V$  and recall that polynomials are continuous.
10. Let  $V \subset k^n$  be a variety containing the origin and let  $\mathcal{V} \subset k^{n+1}$  be the set described in (5). Given  $\lambda \in k$ , consider the "slice"  $(k^n \times \{\lambda\}) \cap \mathcal{V}$ . Assume that  $k$  is infinite.
- a. When  $\lambda \neq 0$ , show that this slice equals  $V_\lambda \times \{\lambda\}$ , where  $V_\lambda = \{v \in k^n : \lambda v \in V\}$ . Also show that  $V_\lambda$  is an affine variety.
  - b. Show that  $V_1 = V$ , and, more generally, for  $\lambda \neq 0$ , show that  $V_\lambda$  is isomorphic to  $V$ . Hint: Consider the polynomial map defined by sending  $(x_1, \dots, x_n)$  to  $(\lambda x_1, \dots, \lambda x_n)$ .
  - c. Suppose that  $k = \mathbb{R}$  or  $\mathbb{C}$  and that  $\lambda \neq 0$  is close to the origin. Explain why  $V_\lambda$  gives a picture of  $V$  where we have expanded the scale by a factor of  $1/\lambda$ . Conclude that as  $\lambda \rightarrow 0$ ,  $V_\lambda$  shows what  $V$  looks like as we "zoom in" at the origin.
  - d. Use (6) to show that  $V_0 = C_0(V)$ . Explain what this means in terms of the "zooming in" described in part (c).
11. If  $p \in V \subset k^n$ , show that  $C_p(V) \subset T_p(V)$ .
12. If  $k$  is an infinite field and  $V \subset k^n$  is a subspace (in the sense of linear algebra), then prove that  $V$  is irreducible. Hint: In Exercise 7 of §1, you showed that this was true when  $V$  was a coordinate subspace. Now pick an appropriate basis of  $k^n$ .
13. Let  $W \subset \mathbb{P}^{n-1}(\mathbb{C})$  be a nonempty projective variety and let  $C_W \subset \mathbb{C}^n$  be its affine cone.
- a. Prove that the tangent cone of  $C_W$  at the origin is  $C_W$ .
  - b. Prove that the origin is a smooth point of  $C_W$  if and only if  $W$  is a projective linear subspace of  $\mathbb{P}^{n-1}(\mathbb{C})$ . Hint: Use Corollary 9.

In Exercises 14-17, we will study the "blow-up" of a variety  $V$  at a point  $p \in V$ . The blowing-up process gives us a map of varieties  $\pi : \tilde{V} \rightarrow V$  such that away from  $p$ , the two varieties look the same, but at  $p$ ,  $\tilde{V}$  can be much larger than  $V$ , depending on what the tangent cone  $C_p(V)$  looks like.

14. Let  $k$  be an arbitrary field. In §5 of Chapter 8, we studied varieties in  $\mathbb{P}^{n-1} \times k^n$ , where  $\mathbb{P}^{n-1} = \mathbb{P}^{n-1}(k)$ . Let  $y_1, \dots, y_n$  be homogeneous coordinates in  $\mathbb{P}^{n-1}$  and let  $x_1, \dots, x_n$  be coordinates in  $k^n$ . Then the  $(y_1, \dots, y_n)$ -homogeneous polynomials  $x_i y_j - x_j y_i$  (this is the terminology of Chapter 8, §5) define a variety  $\Gamma \subset \mathbb{P}^{n-1} \times k^n$ . This variety has some interesting properties.
- a. If  $(p, q) \in \mathbb{P}^{n-1} \times k^n$ , then interpreting  $p$  as homogeneous coordinates and  $q$  as ordinary coordinates, show that  $(p, q) \in \Gamma$  if and only if  $q = tp$  for some  $t \in k$  (which might be zero).
  - b. If  $q \neq 0$  is in  $k^n$ , show that  $(\mathbb{P}^{n-1} \times \{q\}) \cap \Gamma$  consists of a single point [which can be thought of as  $(q, q)$ , where the first  $q$  is the point of  $\mathbb{P}^{n-1}$  with homogeneous coordinates given by  $q \in k^n - \{0\}$ ]. On the other hand, when  $q = 0$ , show that  $(\mathbb{P}^{n-1} \times \{q\}) \cap \Gamma = \mathbb{P}^{n-1} \times \{0\}$ .
  - c. If  $\pi : \Gamma \rightarrow k^n$  is the projection map, conclude that  $\pi^{-1}(q)$  consists of a single point, except when  $q = 0$ , in which case  $\pi^{-1}(0)$  is a copy of  $\mathbb{P}^{n-1}$ . Hence, we can regard  $\Gamma$

as the variety obtained by removing the origin from  $k^n$  and replacing it by a copy of  $\mathbb{P}^{n-1}$ .

- d. To see what the  $\mathbb{P}^{n-1} \times \{0\} \subset \Gamma$  means, consider a line  $L$  through the origin parametrized by  $tv$ . Show that the points  $(v, tv) \in \mathbb{P}^{n-1} \times k^n$  lie in  $\Gamma$  and, hence, describe a curve  $L \subset \Gamma$ . Investigate where this curve meets  $\mathbb{P}^{n-1} \times \{0\}$  and conclude that distinct lines through the origin in  $k^n$  give distinct points in  $\pi^{-1}(0)$ . Thus, the difference between  $\Gamma$  and  $k^n$  is that  $\Gamma$  separates tangent directions at the origin. We call  $\pi : \Gamma \rightarrow k^n$  the *blow-up* of  $k^n$  at the origin.
15. This exercise is a continuation of Exercise 14. Let  $V \subset k^n$  be a variety containing the origin and assume that the origin is not an irreducible component of  $V$ . Our goal here is to define the blow-up of  $V$  at the origin. Let  $\Gamma \subset \mathbb{P}^{n-1} \times k^n$  be as in the previous exercise. Then  $\tilde{V} \subset \Gamma$  is defined to be the smallest variety in  $\mathbb{P}^{n-1} \times k^n$  containing  $(\mathbb{P}^{n-1} \times (V - \{0\})) \cap \Gamma$ . If  $\pi : \Gamma \rightarrow k^n$  is as in Exercise 14, then prove that  $\pi(\tilde{V}) \subset V$ . Hint: First show that  $\tilde{V} \subset \mathbb{P}^{n-1} \times V$ .
- This exercise shows we have a map  $\pi : \tilde{V} \rightarrow V$ , which is called the *blow-up* of  $V$  at the origin. By Exercise 14, we know that  $\pi^{-1}(q)$  consists of a single point for  $q \neq 0$  in  $V$ . In Exercise 16, you will describe  $\pi^{-1}(0)$  in terms of the tangent cone of  $V$  at the origin.
16. Let  $V \subset k^n$  be a variety containing the origin and assume that the origin is not an irreducible component of  $V$ . We know that tangent cone  $C_0(V)$  is the affine cone  $C_W$  over some projective variety  $W \subset \mathbb{P}^{n-1}$ . We call  $W$  the *projectivized tangent cone* of  $V$  at 0. The goal of this exercise is to show that if  $\pi : \tilde{V} \rightarrow V$  is the blow-up of  $V$  at 0 as defined in Exercise 15, then  $\pi^{-1}(0) = W \times \{0\}$ .
- Show that our assumption that  $\{0\}$  is not an irreducible component of  $V$  implies that  $k$  is infinite and that  $V$  is the Zariski closure of  $V - \{0\}$ .
  - Let  $g \in k[y_1, \dots, y_n, x_1, \dots, x_n]$ . Then show that  $g \in \mathbf{I}(\tilde{V})$  if and only if  $g(q, tq) = 0$  for all  $q \in V - \{0\}$  and all  $t \in k - \{0\}$ . Hint: Use part (a) of Exercise 14.
  - Then show that  $g \in \mathbf{I}(\tilde{V})$  if and only if  $g(q, tq) = 0$  for all  $q \in V$  and all  $t \in k$ . Hint: Use parts (a) and (b).
  - Explain why  $\mathbf{I}(\tilde{V})$  is generated by  $(y_1, \dots, y_n)$ -homogeneous polynomials.
  - Assume that  $g = \sum_{\alpha} g_{\alpha}(y_1, \dots, y_n)x^{\alpha} \in \mathbf{I}(\tilde{V})$ . By part (d), we may assume that the  $g_{\alpha}$  are all homogeneous of the same total degree  $d$ . Let

$$f(x_1, \dots, x_n) = \sum_{\alpha} g_{\alpha}(x_1, \dots, x_n)x^{\alpha}.$$

Then show that  $f \in \mathbf{I}(V)$ . Hint: First show that  $g(x_1, \dots, x_n, tx_1, \dots, tx_n) = f(x_1, \dots, x_n)t^d$ , and then use part (c).

- Prove that  $W \times \{0\} \subset \tilde{V} \cap (\mathbb{P}^{n-1} \times \{0\})$ . Hint: It suffices to show that  $g(v, 0) = 0$  for  $g \in \mathbf{I}(\tilde{V})$  and  $v \in C_0(V)$ . In the notation of part (e) note that  $g(v, 0) = g_0(v)$ . If  $g_0 \neq 0$ , show that  $g_0 = f_{\min}$ , where  $f$  is the polynomial defined in part (e).
- Prove that  $V \cap (\mathbb{P}^{n-1} \times \{0\}) \subset W \times \{0\}$ . Hint: If  $f = f_l + \dots + f_d \in \mathbf{I}(V)$ , where  $f_l = f_{\min}$ , let  $g$  be the remainder of  $t^l f$  on division by  $tx_1 - y_1, \dots, tx_n - y_n$ . Show that  $t$  does not appear in  $g$  and that  $g \in \mathbf{I}(\tilde{V})$ . Then compute  $g(v, 0)$  using the techniques of parts (e) and (f).

A line in the tangent cone can be regarded as a way of approaching the origin through points of  $V$ . So we can think of the projectivized tangent cone  $W$  as describing all possible ways of approaching the origin within  $V$ . Then  $\pi^{-1}(0) = W \times \{0\}$  means that each of these different ways gives a distinct point in the blow-up. Note how this generalizes Exercise 14.

17. Assume that  $k$  is an algebraically closed field and suppose that  $V = \mathbf{V}(f_1, \dots, f_s) \subset k^n$  contains the origin.
- By analyzing what you did in part (g) of Exercise 16, explain how to find defining equations for the blow-up  $\tilde{V}$ .
  - Compute the blow-up at the origin of  $\mathbf{V}(y^2 - x^2 - x^3)$  and describe how your answer relates to the first picture in Example 1.
  - Compute the blow-up at the origin of  $\mathbf{V}(y^2 - x^3)$ .

Note that in parts (b) and (c), the blow-up is a smooth curve. In general, blowing-up is an important tool in what is called *desingularizing* a variety with singular points.

# Appendix A

## Some Concepts from Algebra

This appendix contains precise statements of various algebraic facts and definitions used in the text. For students who have had a course in abstract algebra, much of this material will be familiar. For students seeing these terms for the first time, keep in mind that the abstract concepts defined here are used in the text in very concrete situations.

### §1 Fields and Rings

We first give a precise definition of a field.

**Definition 1.** A **field** consists of a set  $k$  and two binary operations “ $\cdot$ ” and “ $+$ ” defined on  $k$  for which the following conditions are satisfied:

- (i)  $(a+b)+c = a+(b+c)$  and  $(a \cdot b) \cdot c = a \cdot (b \cdot c)$  for all  $a, b, c \in k$  (associative).
- (ii)  $a+b = b+a$  and  $a \cdot b = b \cdot a$  for all  $a, b \in k$  (commutative).
- (iii)  $a \cdot (b+c) = a \cdot b + a \cdot c$  for all  $a, b, c \in k$  (distributive).
- (iv) There are  $0, 1 \in k$  such that  $a+0 = a \cdot 1 = a$  for all  $a \in k$  (identities).
- (v) Given  $a \in k$ , there is  $b \in k$  such that  $a+b = 0$  (additive inverses).
- (vi) Given  $a \in k, a \neq 0$ , there is  $c \in k$  such that  $a \cdot c = 1$  (multiplicative inverses).

The fields most commonly used in the text are  $\mathbb{Q}$ ,  $\mathbb{R}$ , and  $\mathbb{C}$ . In the exercises to §1 of Chapter 1, we mention the field  $\mathbb{F}_2$  which consists of the two elements 0 and 1. Some more complicated fields are discussed in the text. For example, in §3 of Chapter 1, we define the field  $k(t_1, \dots, t_m)$  of rational functions in  $t_1, \dots, t_m$  with coefficients in  $k$ . Also, in §5 of Chapter 5, we introduce the field  $k(V)$  of rational functions on an irreducible variety  $V$ .

If we do not require multiplicative inverses, then we get a commutative ring.

**Definition 2.** A **commutative ring** consists of a set  $R$  and two binary operations “ $\cdot$ ” and “ $+$ ” defined on  $R$  for which the following conditions are satisfied:

- (i)  $(a+b)+c = a+(b+c)$  and  $(a \cdot b) \cdot c = a \cdot (b \cdot c)$  for all  $a, b, c \in R$  (associative).

- (ii)  $a + b = b + a$  and  $a \cdot b = b \cdot a$  for all  $a, b \in R$  (commutative).
- (iii)  $a \cdot (b + c) = a \cdot b + a \cdot c$  for all  $a, b, c \in R$  (distributive).
- (iv) There are  $0, 1 \in R$  such that  $a + 0 = a \cdot 1 = a$  for all  $a \in R$  (identities).
- (v) Given  $a \in R$ , there is  $b \in R$  such that  $a + b = 0$  (additive inverses).

Note that any field is obviously a commutative ring. Other examples of commutative rings are the integers  $\mathbb{Z}$  and the polynomial ring  $k[x_1, \dots, x_n]$ . The latter is the most commonly used ring in the book. In Chapter 5, we construct two other commutative rings: the coordinate ring  $k[V]$  of polynomial functions on an affine variety  $V$  and the quotient ring  $k[x_1, \dots, x_n]/I$ , where  $I$  is an ideal of  $k[x_1, \dots, x_n]$ .

A special case of commutative rings are the *integral domains*.

**Definition 3.** A commutative ring  $R$  is an **integral domain** if whenever  $a, b \in R$  and  $a \cdot b = 0$ , then either  $a = 0$  or  $b = 0$ .

Any field is an integral domain, and the polynomial ring  $k[x_1, \dots, x_n]$  is an integral domain. In Chapter 5, we prove that the coordinate ring  $k[V]$  of a variety  $V$  is an integral domain if and only if  $V$  is irreducible.

Finally, we note that the concept of ideal can be defined for any ring.

**Definition 4.** Let  $R$  be a commutative ring. A subset  $I \subset R$  is an **ideal** if it satisfies:

- (i)  $0 \in I$ .
- (ii) If  $a, b \in I$ , then  $a + b \in I$ .
- (iii) If  $a \in I$  and  $b \in R$ , then  $b \cdot a \in I$ .

Note how this generalizes the definition of ideal given in §4 of Chapter 1.

## §2 Groups

A group can be defined as follows.

**Definition 1.** A **group** consists of a set  $G$  and a binary operation “ $\cdot$ ” defined on  $G$  for which the following conditions are satisfied:

- (i)  $(a \cdot b) \cdot c = a \cdot (b \cdot c)$  for all  $a, b, c \in G$  (associative).
- (ii) There is  $1 \in G$  such that  $1 \cdot a = a \cdot 1 = a$  for all  $a \in G$  (identity).
- (iii) Given  $a \in G$ , there is  $b \in G$  such that  $a \cdot b = b \cdot a = 1$  (inverses).

A simple example of a group is given by the integers  $\mathbb{Z}$  under addition. Note  $\mathbb{Z}$  is not a group under multiplication. A more interesting example comes from linear algebra. Let  $k$  be a field and define

$$\mathrm{GL}(n, k) = \{A : A \text{ is an invertible } n \times n \text{ matrix with entries in } k\}.$$

From linear algebra, we know that the product  $AB$  of two invertible matrices  $A$  and  $B$  is again invertible. Thus, matrix multiplication defines a binary operation on  $\mathrm{GL}(n, k)$ , and it is easy to verify that all of the group axioms are satisfied.

For a final example of a group, let  $n$  be a positive integer and consider the set

$$S_n = \{\sigma : \{1, \dots, n\} \rightarrow \{1, \dots, n\} : \sigma \text{ is one-to-one and onto}\}.$$

Then composition of functions turns  $S_n$  into a group. Since elements  $\sigma \in S_n$  can be regarded as permutations of the numbers 1 through  $n$ , we call  $S_n$  the *permutation group*. Note that  $S_n$  has  $n!$  elements.

Finally, we need the notion of a subgroup.

**Definition 2.** Let  $G$  be a group. A subset  $H \subset G$  is called a **subgroup** if it satisfies:

- (i)  $1 \in H$ .
- (ii) If  $a, b \in H$ , then  $a \cdot b \in H$ .
- (iii) If  $a \in H$ , then  $a^{-1} \in H$ .

In Chapter 7, we study finite subgroups of the group  $GL(n, k)$ .

### §3 Determinants

Our first goal is to give a formula for the determinant of an  $n \times n$  matrix. We begin by defining the *sign* of a permutation. Recall that the group  $S_n$  was defined in §2 of this appendix.

**Definition 1.** If  $\sigma \in S_n$ , let  $P_\sigma$  be the matrix obtained by permuting the columns of the  $n \times n$  identity according to  $\sigma$ . Then the **sign** of  $\sigma$ , denoted  $\text{sgn}(\sigma)$ , is defined by

$$\text{sgn}(\sigma) = \det(P_\sigma).$$

Note that we can transform  $P_\sigma$  back to the identity matrix by successively switching columns two at a time. Since switching two columns of a determinant changes its sign, it follows that  $\text{sgn}(\sigma)$  equals  $\pm 1$ . Then one can prove that the determinant is given by the following formula.

**Proposition 2.** If  $A = (a_{ij})$  is an  $n \times n$  matrix, then

$$\det(A) = \sum_{\sigma \in S_n} \text{sgn}(\sigma) a_{1\sigma(1)} \cdots a_{n\sigma(n)}.$$

**Proof.** A proof is given in Chapter 5, §3 of FINKBEINER (1978). □

This formula is used in a crucial way in our treatment of resultants (see Proposition 8 from Chapter 3, §5).

A second fact we need concerns the solution of a linear system of  $n$  equations in  $n$  unknowns. In matrix form, the system is written

$$AX = B,$$



where  $A = (a_{ij})$  is the  $n \times n$  coefficient matrix,  $B$  is a column vector, and  $X$  is the column vector whose entries are the unknowns  $x_1, \dots, x_n$ . When  $A$  is invertible, the system has the unique solution given by  $X = A^{-1}B$ . One can show that this leads to the following explicit formula for the solution.

**Proposition 3 (Cramer's Rule).** *Suppose we have a system of equations  $AX = B$ . If  $A$  is invertible, then the unique solution is given by*

$$x_i = \frac{\det(M_i)}{\det(A)},$$

where  $M_i$  is the matrix obtained from  $A$  by replacing its  $i$ -th column with  $B$ .

**Proof.** A proof can be found in Chapter 5, §3 of FINKBEINER (1978). □

This proposition is used to prove some basic properties of resultants (see Proposition 9 from Chapter 3, §5).

# Appendix B

## Pseudocode

Pseudocode is commonly used in mathematics and computer science to present algorithms. In this appendix, we will describe the pseudocode used in the text. If you have studied a programming language, you may see a similarity between our pseudocode and the language you studied. This is no accident, since programming languages are also designed to express algorithms. The syntax, or “grammatical rules,” of our pseudocode will not be as rigid as that of a programming language since we do not require that it run on a computer. However, pseudocode serves much the same purpose as a programming language.

As indicated in the text, an algorithm is a specific set of instructions for performing a particular calculation with numerical or symbolic information. Algorithms have *inputs* (the information the algorithm will work with) and *outputs* (the information that the algorithm produces). At each step of an algorithm, the next operation to be performed must be completely determined by the current state of the algorithm. Finally, an algorithm must always terminate after a finite number of steps.

Whereas a simple algorithm may consist of a sequence of instructions to be performed one after the other, most algorithms also use the following special structures:

- Repetition structures, which allow a sequence of instructions to be repeated. These structures are also known as *loops*. The decision whether to repeat a group of instructions can be made in several ways, and our pseudocode includes different types of repetition structures adapted to different circumstances.
- Branching structures, which allow the possibility of performing different sequences of instructions under different circumstances that may arise as the algorithm is executed.

These structures, as well as the rest of the pseudocode, will be described in more detail in the following sections.

### §1 Inputs, Outputs, Variables, and Constants

We always specify the inputs and outputs of our algorithms on two lines before the start of the algorithm proper. The inputs and outputs are given by symbolic names in

usual mathematical notation. Sometimes, we do not identify what *type* of information is represented by the inputs and outputs. In this case, their meaning should be clear from the context of the discussion preceding the algorithm. Variables (information stored for use during execution of the algorithm) are also identified by symbolic names. We freely introduce new variables in the course of an algorithm. Their types are determined by the context. For example, if a new variable called  $a$  appears in an instruction, and we set  $a$  equal to a polynomial, then  $a$  should be treated as a polynomial from that point on. Numerical constants are specified in usual mathematical notation. The two words *true* and *false* are used to represent the two possible truth values of an assertion.

## §2 Assignment Statements

Since our algorithms are designed to describe mathematical operations, by far the most common type of instruction is the *assignment* instruction. The syntax is

$$\langle \text{variable} \rangle := \langle \text{expression} \rangle .$$

The symbol  $:=$  is the same as the assignment operator in Pascal. The meaning of this instruction is as follows. First, we *evaluate* the expression of the right of the assignment operator, using the currently stored values for any variables that appear. Then the result is stored in the variable on the left-hand side. If there was a previously stored value in the variable on the left-hand side, the assignment *erases* it and *replaces* it with the computed value from the right-hand side. For example, if a variable called  $i$  has the numerical value 3, and we execute the instruction

$$i := i + 1,$$

the value  $3 + 1 = 4$  is computed and stored in  $i$ . After the instruction is executed,  $i$  will contain the value 4.

## §3 Looping Structures

Three different types of repetition structures are used in the algorithms given in the text. They are similar to the ones used in many languages. The most general and most frequently used repetition structure in our algorithms is the WHILE structure. The syntax is

$$\text{WHILE } \langle \text{condition} \rangle \text{ DO } \langle \text{action} \rangle .$$

Here,  $\langle \text{action} \rangle$  is a sequence of instructions. In a WHILE structure, the action is the group of statements to be repeated. We always indent this sequence of instructions. The *end* of the action is signalled by a return to the level of indentation used for the WHILE statement itself.

The  $\langle \text{condition} \rangle$  after the WHILE is an assertion about the values of variables, etc., that is either true or false at each step of the algorithm. For instance, the condition

$$i \leq s \text{ AND } \text{divisionoccurred} = \text{false}$$

appears in a WHILE loop in the division algorithm from Chapter 2, §3.

When we reach a WHILE structure in the execution of an algorithm, we determine whether the condition is true or false. If it is *true*, then the action is performed once, and we go back and test the condition again. If it is still true, we repeat the action once again. Continuing in the same way, the action will be repeated as long as the condition remains true. When the condition becomes false (at some point during the execution of the action), that iteration of the action will be completed, and then the loop will terminate. To summarize, in a WHILE loop, the condition is tested *before* each repetition, and that condition must be *true* for the repetition to go on.

A second repetition structure that we use on occasion is the REPEAT structure. A REPEAT loop has the syntax

REPEAT  $\langle \text{action} \rangle$  UNTIL  $\langle \text{condition} \rangle$ .

Reading this as an English sentence indicates its meaning. Unlike the condition in a WHILE, the condition in a REPEAT loop tells us when to *stop*. In other words, the action will be repeated as long as the condition is *false*. In addition, the action of a REPEAT loop is always performed at least once since we only test the condition *after* doing the sequence of instructions representing the action. As with a WHILE structure, the instructions in the action are indented.

The final repetition structure that we use is the FOR structure. We use the syntax

FOR each  $s$  in  $S$  DO  $\langle \text{action} \rangle$

to represent the instruction: “perform the indicated action for each element  $s \in S$ .” Here  $S$  is a finite set of objects and the action to be performed will usually depend on which  $s$  we are considering. The order in which the elements of  $S$  are considered is not important. Unlike the previous repetition structures, the FOR structure will necessarily cause the action to be performed a fixed number of times (namely, the number of elements in  $S$ ).

## §4 Branching Structures

We use only one type of branching structure, which is general enough for our purposes. The syntax is

IF  $\langle \text{condition} \rangle$  THEN  $\langle \text{action1} \rangle$  ELSE  $\langle \text{action2} \rangle$ .

The meaning is as follows. If the condition is true at the time the IF is reached, action 1 is performed (once only). Otherwise (that is, if the condition was false), action2 is performed (again, once only). The instructions in action 1 and action2 are indented, and

the ELSE separates the two sequences of instructions. The end of action2 is signalled by a return to the level of indentation used for the IF and ELSE statements.

In this branching structure, the truth or falsity of the condition selects which action to perform. In some cases, we *omit* the ELSE and action2. This form is equivalent to

IF <condition> THEN <action1> ELSE do nothing.

# Appendix C

## Computer Algebra Systems

This appendix will discuss several computer algebra systems that can be used in conjunction with the text. We will describe AXIOM, Maple, Mathematica and REDUCE in some detail, and then mention some other systems. These are all amazingly powerful programs, and our brief discussion will not do justice to their true capability.

It is important to note that we will *not* give a general introduction to any of the computer algebra systems we will discuss. This is the responsibility of your course instructor. In particular, we will assume that you already know the following:

- How to enter and exit the program, and how to enter commands and polynomials. Some systems require semicolons at the end of commands (such as Maple and REDUCE), while others do not. Also, some systems (such as Mathematica) are case sensitive, while others are not. Some systems require an asterisk for multiplication (such as AXIOM), while others do not.
- How to refer to previous commands, and how to save results in a file. The latter can be important, especially when an answer fills more than one computer screen. You should be able to save the answer in a file and print it out for further study.
- How to work with lists. For example, in the Groebner basis command, the input contains a list of polynomials, and the output is another list which is a Groebner basis for the ideal generated by the polynomials in the input list. You should be able to find the length of a list and extract polynomials from a list.
- How to assign symbolic names to objects. In many computations, the best way to deal with complicated data is to use symbolic names for polynomials, lists of polynomials, lists of variables, etc.

If a course being taught from this book has a laboratory component, we would suggest that the instructor use the first lab meeting to cover the above aspects of the particular computer algebra system being used.

### §1 AXIOM

AXIOM is a version of SCRATCHPAD, which was developed by IBM over a period of many years. AXIOM is now freely available from <http://www.nongnu.org/axiom>. Our discussion applies to version 2.0. For us, the most important AXIOM commands

are `normalForm`, for doing the division algorithm, and `groebner`, for computing a Groebner basis.

A distinctive feature of AXIOM is that every object has a specific type. In particular, this affects the way AXIOM works with monomial orders: an order is encoded in a special kind of type. For example, suppose we want to use lex order on  $\mathbb{Q}[x, y, z]$  with  $x > y > z$ . This is done by using the type `DMP([x, y, z], FRAC INT)` (remember that AXIOM encloses a list inside brackets [...]). Here, `DMP` stands for “Distributed Multivariate Polynomial,” and `FRAC INT` means fractions of integers, i.e., rational numbers. Similarly, `grevlex` for  $\mathbb{Q}[x, y, z]$  with  $x > y > z$  means using the type `HDMP([x, y, z], FRAC INT)`, where `HDMP` stands for “Homogeneous Distributed Multivariate Polynomial.” At the end of the section, we will explain how to get AXIOM to work with `grlex` order.

To see how this works in practice, we will divide  $x^3 + 3y^2$  by  $x^2 + y$  and  $x + 2xy$  using `grevlex` order with  $x > y$ . We first give the three polynomials names and declare their types:

```
-> f : HDMP([x, y], FRAC INT) := x^3+3*y^2
-> g : HDMP([x, y], FRAC INT) := x^2+y
-> h : HDMP([x, y], FRAC INT) := x+2*x*y
```

(Here, `->` is the AXIOM prompt, and the colon `:` indicates a type declaration. You can save typing by giving `HDMP([x, y], FRAC INT)` a symbolic name.) Then the remainder is computed by the command:

```
-> normalForm(f, [g, h])
```

The output is the remainder of `f` on division by `g, h`. In general, the syntax for this command is:

```
-> normalForm(poly, polylist)
```

where `poly` is the polynomial to be divided by the polynomials in the list `polylist` (assuming that everything has been declared to be of the appropriate type).

To do the same computation using lex order with  $x > y$ , first issue the command:

```
-> Lex := DMP([x, y], FRAC INT)
```

to give `DMP([x, y], FRAC INT)` the symbolic name `Lex`, and then type:

```
-> normalForm(f::Lex, [g::Lex, h::Lex])
```

Here, we are using AXIOM’s type conversion facility `::` to convert from one type to another.

The syntax for the `groebner` command is:

```
-> groebner(polylist)
```

This computes a Groebner basis for the ideal generated by the polynomials in `polylist` (of the appropriate type). The answer is reduced in the sense of Chapter 2, §7. For example, if `g, h` are as above, then the command:

```
-> gb := groebner([g, h])
```

computes a list (and gives it the symbolic name `gb`) which is a Groebner basis for the ideal  $\langle x^2 + y, x + 2xy \rangle \subset \mathbb{Q}[x, y]$  with respect to `grevlex` for  $x > y$ . Also, if you want information about the intermediate stages of the calculation, you can include the options `"redcrit"` or `"info"` in the `groebner` command. For example, the command:

```
-> groebner([g, h], "redcrit")
```

will print out the remainders of S-polynomials (only one in this case) generated during the course of the computation. Adding the "info" option yields even more information.

AXIOM can also work with coefficients in a variety of fields besides  $\mathbb{Q}$ . This is easily done by replacing `FRAC INT` in the type declaration. For instance, to compute Groebner bases over the field of rational functions in polynomials with integer coefficients, one uses `FRAC POLY INT`. To see how this works, let us compute a Groebner basis for the ideal  $\langle vx^2 + y, uxy + y^2 \rangle \subset \mathbb{Q}(u, v)[x, y]$  using lex order with  $x > y$ . This is accomplished by the following AXIOM commands:

```
-> m : List DMP([x,y],FRAC POLY INT)
-> m := [v*x^2+y,u*x*y+y^2]
-> groebner(m)
```

Notice that this illustrates another method for declaring the type of the polynomials used in a Groebner basis computation.

Other fields are just as easy: one uses `FRAC COMPLEX INT` for the field of Gaussian rational numbers  $\mathbb{Q}(i) = \{a + bi : a, b \in \mathbb{Q}\}$  (note that AXIOM writes  $i = \sqrt{-1}$  as %i) and `PrimeField(p)` for a finite field with  $p$  elements (where  $p$  is a prime). It is also possible to compute Groebner bases over arbitrary finite fields. AXIOM's method of working with finite fields is explained in Section 8.11 of JENKS and SUTOR (1992). The ability to simply "insert" the field you want to compute Groebner bases over is a good illustration of the power of AXIOM.

Besides working with lists of polynomials, AXIOM also allows the user to declare a list of polynomials to be an ideal. The syntax of the ideal command is:

```
-> ideal polylist
```

where `polylist` is a list of polynomials of the appropriate type. This is useful because AXIOM has a number of commands which apply to ideals, including:

- `intersect`, which computes the intersection of a list of ideals.
- `zeroDim?`, which determines (using the methods of Chapter 5, §3) if the equations have finitely many solutions over an algebraically closed field.
- `dimension`, which computes the dimension of the variety defined by an ideal.
- `prime?`, which determines whether an ideal is prime.
- `radical`, which computes the radical of an ideal.
- `primaryDecomp`, which computes the primary decomposition of an ideal.

Examples of how to use these and other related AXIOM commands can be found in Section 8.12 of JENKS and SUTOR (1992). We should also mention that there are the commands `leadingMonomial` and `leadingCoefficient` for extracting the leading term and coefficient of a polynomial.

All of the commands described so far require that you declare in advance the type of polynomial you'll be using. However, if you only need Groebner bases in lex or grevlex order with rational coefficients, then a simpler approach is to use the AXIOM commands `lexGroebner` and `totalGroebner`. For example, the command:

```
-> lexGroebner([2*x^2+y,2*y^2+x],[x,y])
```

computes a Groebner basis (reduced up to constants) for the ideal  $\langle 2x^2 + y, 2y^2 + x \rangle \subset \mathbb{Q}[x, y]$  using lex order with  $x > y$ . Notice that we didn't have to declare the type of the polynomials in advance—`lexGroebner` takes care of this. To do the same computation using grevlex, simply replace `lexGroebner` with `totalGroebner`.



We will end this section by explaining how to get AXIOM to work with `grlex` order. All of the raw material needed is present in AXIOM, though it takes a little work to put it together. For concreteness, suppose we want `grlex` order on  $\mathbb{Q}[x, y]$  with  $x > y$ . Then issue the commands:

```
-> )set expose add constructor GDMP
-> )set expose add constructor ODP
-> Grlex := GDMP ([x, y], FRAC INT, ODP (2, NNI, totalLex$ORDFUNS
(2, NNI)))
```

The basic idea here is that `GDMP` stands for “General Distributed Multivariate Polynomial,” which can be used to create an AXIOM type for *any* monomial order, and `totalLex` is the function which orders exponent vectors using `grlex`. By declaring polynomials to be of type `Grlex`, you can now compute Groebner bases using `grlex` with  $x > y$ . We should caution that type conversion doesn’t work between `Grlex` and the monomial orders created by `DMP` and `HDMP`, though it is possible to write type conversion routines. Using the AXIOM concept of a package, one could write a package which knows all of the monomial orders mentioned in the exercises to Chapter 2, §4, along with commands to convert from one type to the other.

## §2 Maple

Our discussion applies to Maple 9.5. For us, the most important part of Maple is the Groebner package. To have access to the commands in this package, type:

```
> with(Groebner);
```

(here `>` is the Maple prompt, and as usual, all Maple commands end with a semicolon). Once the `Groebner` package is loaded, you can perform the division algorithm, compute Groebner bases, and carry out a variety of other commands described below.

In Maple, a monomial ordering is called a `termorder`. Of the monomial orderings considered in Chapter 2, the easiest to use are `lex` and `grevlex`. `Lex` order is called `plex` (for “pure lexicographic”), and `grevlex` order is called `tdeg` (for “total degree”). Be careful not to confuse `tdeg` with `grlex`. Since a monomial order depends also on how the variables are ordered. Maple needs to know both the `termorder` you want (`plex` or `tdeg`) *and* a list of variables. For example, to tell Maple to use `lex` order with variables  $x > y > z$ , you would need to input `plex (x, y, z)`.

This package also knows an elimination order, as defined in Exercise 5 of Chapter 3, §1. To eliminate the first  $k$  variables from  $x_1, \dots, x_n$ , one can use `lexdeg ([x_1, \dots, x_k], [x_{k+1}, \dots, x_n])` (remember that Maple encloses a list inside brackets `[...]`). This order is similar (but not identical to) to the elimination order of Bayer and Stillman described in Exercise 6 of Chapter 3, §1.

The Maple documentation for the `Groebner` package also describes how to use certain weighted orders, and we will explain below how matrix orders give us many more monomial orderings.

The most commonly used commands in Maple’s `Groebner` package are `normalf`, for doing the division algorithm, and `gbasis`, for computing a Groebner basis. The name `normalf` stands for “normal form”, and the command has the following syntax:

```
> normalf(f, polylist, term_order);
```

The output is the remainder of  $f$  on division by the polynomials in the list `polylist` using the monomial ordering specified by `term_order`. For example, to divide  $x^3 + 3y^2$  by  $x^2 + y$  and  $x + 2xy$  using `grevlex` order with  $x > y$ , one would enter:

```
> normalf(x^3+3*y^2, [x^2+y, x+2*x*y], tdeg(x, y));
```

The base field here is the rational numbers  $\mathbb{Q}$ . Note that `normalf` does not give the quotients in the division algorithm.

As you might expect, `gbasis` stands for “Groebner basis”, and the syntax is as follows:

```
> gbasis(polylist, term_order);
```

This computes a Groebner basis for the ideal generated by the polynomials in `polylist` with respect to the monomial ordering specified by `term_order`. The answer is a reduced Groebner basis (in the sense of Chapter 2, §7), except for clearing denominators. As an example of how `gbasis` works, consider the command:

```
> gb := gbasis([x^2+y, 2*x*y+y^2], plex(x, y));
```

This computes a list (and gives it the symbolic name `gb`) which is a Groebner basis for the ideal  $(x^2 + y, 2xy + y^2) \subset \mathbb{Q}[x, y]$  using `lex` order with  $x > y$ .

If you use polynomials with integer or rational coefficients in `normalf` or `gbasis`, Maple will assume that you are working over the field  $\mathbb{Q}$ . Note that there is no limitation on the size of the coefficients. Maple can also work with coefficients that lie in rational function fields. To tell Maple that a certain variable is in the base field (a “parameter”), you simply omit it from the variable list in the `term_order`. Thus,

```
> gbasis([v*x^2+y, u*x*y+y^2], plex(x, y));
```

will compute a Groebner basis for  $(vx^2 + y, uxy + y^2) \subset \mathbb{Q}(u, v)[x, y]$  for `lex` order with  $x > y$ . The answer is reduced up to clearing denominators (so the leading coefficients of the Groebner basis are polynomials in  $u$  and  $v$ ).

The Groebner package can also work with matrix orders by using the `Ore_algebra` package, which is loaded via the command:

```
> with(Ore_algebra);
```

Using Maple notation for matrices, suppose that  $[u_1, \dots, u_n]$  is invertible matrix, where each  $u_i = [u_{i1}, \dots, u_{in}]$  is a vector in  $\mathbb{Z}_{\geq 0}^n$ . Then define  $x^\alpha > x^\beta$  if

$$u_{i1} \cdot \alpha > u_{i1} \cdot \beta, \text{ or } u_{i1} \cdot \alpha = u_{i1} \cdot \beta \text{ and } u_{i2} \cdot \alpha > u_{i2} \cdot \beta, \text{ or } \dots$$

Order of this type are discussed (from a slightly more general point of view) in the remarks following Exercise 12 of Chapter 2, §4.

To see how such an order can be entered into Maple, suppose that we want to use `grevlex` with  $x > y > z$ . This is done via the commands:

```
> B:= poly_algebra(x, y, z);
```

```
> M:= [[1, 1, 1], [1, 0, 0], [0, 1, 0]];
```

```
> GL:= termorder(B, 'matrix'(M, [x, y, z]));
```

(It is a good exercise to show that the monomial ordering given by `GL` is `grevlex` with  $x > y > z$ .) Using `GL` as the `term_order` in the `normalf` or `gbasis` commands, one can now compute remainders or Groebner bases in  $\mathbb{Q}[x, y, z]$ . Using matrix orders, one can create *all* of the monomial orderings described in the book.

When combined, the `Groebner` and `Ore_algebra` packages of Maple 9.5 allow one to do Groebner basis computations for a wide variety of monomial orderings over algebraic number fields, finite fields, or even certain noncommutative rings such as rings of differential operators. Further information can be found in the Maple documentation.

Some other useful Maple commands in the Groebner package are:

- `leadmon`, which computes  $LM(f)$  and  $LC(f)$  for a polynomial  $f$  with respect to `term_order`. Related commands are `leadterm`, which finds  $LM(f)$ , and `leadcoeff`, which finds  $LC(f)$ .
- `spoly`, which computes the S-polynomial  $S(f, g)$  of two polynomials.
- `is_solvable`, which uses the consistency algorithm from Chapter 4, §1 to determine if a system of polynomial equations has a solution over an algebraically closed field.
- `is_finite`, which uses the finiteness algorithm from Chapter 5, §3 to determine if a system of polynomial equations has finitely many solutions over an algebraically closed field.
- `univpoly`, which given a variable and a Groebner basis, computes the polynomial of lowest degree in the given variable which lies in the ideal generated by the Groebner basis.
- `hilbertpoly`, which given a Groebner basis of an ideal  $I$ , computes  ${}^aHP_I(s) - {}^{-a}HP_I(s - 1)$  in the notation of Chapter 9, §3. When  $I$  is a homogenous ideal, Theorem 12 of Chapter 9, §3 shows that `hilbertpoly` computes the Hilbert polynomial  $HP_I(s)$ . A related command is `hilbertseries`, which for a homogenous ideal computes the Hilbert series as defined in Exercise 24 of Chapter 6, §4 of COX, LITTLE, AND O' SHEA (1998).

There is also a `solve` command which attempts to find all solutions of a system of equations. Maple has an excellent on-line help system that should make it easy to master these (and other) Maple commands.

Finally, we should mention the existence of a Maple package written by Albert Lin and Philippe Loustaunau of George Mason University (with subsequent modifications by David Cox and Will Gryc of Amherst College and Chris Wensley of the University of Bangor, Wales) which extends the `Groebner` package. In this package, the program `div_alg` gives the quotients in the division algorithm, and the program `mxgb` computes a Groebner basis together with a matrix telling how to express the Groebner basis in terms of the given polynomials. This package is slow compared to the `Groebner` package, but can be used for many of the simpler examples in the book. There is also a Maple worksheet which explains how to use the package. Copies of the package and worksheet can be obtained from <http://www.cs.amherst.edu/~dac/iva.html>.

### §3 Mathematica

Our discussion applies to Mathematica 5.1. There is no special package to load in order to compute Groebner bases: the basic commands are part of the Mathematica kernel.

Mathematica knows all of the monomial orderings considered in Chapter 2. In typical Mathematica fashion, lex order is called `Lexicographic`, `grlex` is

`DegreeLexicographic` and `grevlex` is `DegreeReverseLexicographic`. The monomial order is determined by using the `MonomialOrder` option within the Mathematica commands described below. If you omit the `MonomialOrder` option, Mathematica will use the default order, which is `lex`. Mathematica can also use the weight orders mentioned in the comments at the end of the exercises to Chapter 2, §4.

Since a monomial order also depends on how the variables are ordered, Mathematica also needs to know a list of variables in order to specify the monomial order order you want. For example, to tell Mathematica to use `lex` order with variables  $x > y > z$ , you would input `{x, y, z}` (remember that Mathematica encloses a list inside braces{...}) into the Mathematica command you want to use.

For our purposes, the most important commands in Mathematica are `PolynomialReduce` and `GroebnerBasis`. One nice feature of `PolynomialReduce` is that it does the division algorithm from Chapter 2 with quotients. The syntax is as follows:

```
In[1] := PolynomialReduce[f, polylist, varlist, options]
```

(where `In[1] :=` is the Mathematica prompt). This computes the quotients and remainder of `f` on division by the polynomials in `polylist` using the monomial order specified by `varlist` and the `MonomialOrder` option. For example, to divide  $x^3 + 3y^2$  by  $x^2 + y$  and  $x + 2xy$  using `grevlex` order with  $x > y$ , one would enter:

```
In[2] := PolynomialReduce[x^3 + 3 y^2, {x^2 + y, x + 2 xy},
    {x, y}, MonomialOrder -> DegreeLexicographic]
```

The output is a list with two entries: the first is a list of the quotients and the second is the remainder.

Of course, the Mathematica command `GroebnerBasis` is used for computing Groebner bases. It has the following syntax:

```
In[3] := GroebnerBasis[polylist, varlist, options]
```

This computes a Groebner basis for the ideal generated by the polynomials in `polylist` with respect to the monomial order given by the `MonomialOrder` option with the variables ordered according to `varlist`. The answer is a reduced Groebner basis (in the sense of Chapter 2, §7), except for clearing denominators. As an example of how `GroebnerBasis` works, consider:

```
In[4] := gb = GroebnerBasis[{x^2+y, 2xy+y^2}, {x, y}]
```

The output is a list (with the symbolic name `gb`) which is a Groebner basis for the ideal  $\langle x^2 + y, 2xy + y^2 \rangle \subset \mathbb{Q}[x, y]$  using `lex` order with  $x > y$ . We omitted the `MonomialOrder` option since `lex` is the default.

If you use polynomials with integer or rational coefficients in `GroebnerBasis` or `PolynomialReduce`, Mathematica will assume that you are working over the field  $\mathbb{Q}$ . There is no limitation on the size of the coefficients. Another possible coefficient field is the Gaussian rational numbers  $\mathbb{Q}(i) = \{a + bi : a, b \in \mathbb{Q}\}$ , where  $i = \sqrt{-1}$  (note that Mathematica uses `I` to denote  $\sqrt{-1}$ ). To compute a Groebner basis over a finite field with  $p$  elements (where  $p$  is a prime number), you need to include the option `Modulus -> p` in the `GroebnerBasis` command. (This option also works in `PolynomialReduce`.)

Mathematica can also work with coefficients that lie in a rational function field. The strategy is that the variables in the base field (the “parameters”) should be omitted

from the variable list in the input, and then one sets the `CoefficientDomain` option to `RationalFunctions`. For example, the command:

```
In[5] := GroebnerBasis[{vx^2+y, uxy+y^2}, {x, y},
    CoefficientDomain -> RationalFunctions]
```

will compute a Groebner basis for  $\langle vx^2 + y, uxy + y^2 \rangle \subset \mathbb{Q}(u, v)[x, y]$  for lex order with  $x > y$ . The answer also clears denominators, so the leading coefficients of the Groebner basis are polynomials in  $u$  and  $v$ . (The `CoefficientDomain` option is also available in `PolynomialReduce`.)

Here are some other useful Mathematica commands:

- `MonomialList`, which lists the terms of a polynomial according to the monomial order.
- `Eliminate`, which uses the Elimination Theorem of Chapter 3, §1 to eliminate variables from a system of polynomial equations.
- `Solve`, which attempts to find all solutions of a system of equations.

For further descriptions and examples, consult *The Mathematica Book* by WOLFRAM (1996).

Finally, there is a Mathematica package written by Susan Goldstine of Amherst College (with an update by Will Gryc, also of Amherst) which includes many commands relevant to the book. Using this package, students can compute Groebner bases, together with information about the number of nonzero remainders that occur. Other algorithms from the book are included, such as ideal membership, radical membership, and finiteness of solutions. This package is slow compared to the `GroebnerBasis` command, but it can be used for most of the simpler examples in the text. Copies of the package can be obtained from <http://www.cs.amherst.edu/~dac/iva.html>.

## §4 REDUCE

Our discussion applies to version 3.5 of REDUCE. To do a Groebner basis calculation with REDUCE, you need to use either the Groebner package or the Cali package.

### *Groebner*

We will describe the version of the Groebner package dated November 18, 1994. To have access to the commands in this package, type:

```
1: load_package groebner;
```

(here, 1: is the REDUCE prompt, and as usual, all REDUCE commands end with a semicolon). Once the Groebner package is loaded, you can perform the division algorithm, compute Groebner bases, and carry out a variety of other commands described below.

In the Groebner package, a monomial ordering is called a term order. Of the monomial orderings considered in Chapter 2, Groebner knows most of them, including lex, grlex and grevlex. Lex order is called `lex`, grlex is called `gradlex`, and grevlex is called `revgradlex`. Groebner also works with product orders (see Exercise 10 of Chapter 2, §4), weight orders (see Exercise 12 of Chapter 2, §4—note that weight orders in

the Groebner package always use lex order to break ties), and more general orders specified by a matrix (see the comments at the end of the Exercises to Chapter 2, §4). These other term orders are described in detail in Section 4.10 of MELENK, MÖLLER and NEUN (1994).

In Groebner, a term order is specified by means of the `torder` command. Since a monomial order depends also on how the variables are ordered, Groebner needs to know both the term order *and* a list of variables. Thus, `torder` commands takes two arguments: a list of variables and the term order. For example, to use grevlex with  $x > y > z$ , you would type:

```
2: torder ({x, y, z}, revgradlex);
```

(remember that REDUCE encloses a list inside braces `{...}`). In response, REDUCE will print out the previous term order.

The most commonly used commands in the Groebner package are `preduce`, for doing the division algorithm, and `groebner`, for computing a Groebner basis. The name `preduce` stands for “polynomial reduce,” and the command has the following syntax:

```
3: preduce(f, polylist);
```

The output is the remainder of  $f$  on division by the polynomials in the list `polylist` using the monomial ordering specified by `torder`. For example, to divide  $x^3 + 3y^2$  by  $x^2 + y$  and  $x + 2xy$  using `grevlex` order with  $x > y$ , one would enter:

```
4: torder ({x, y}, gradlex);
```

```
5: preduce(x^3+3*y^2, {x^2+y, x+2*x*y}, {x, y});
```

In this example, the base field is the rational numbers  $\mathbb{Q}$ . Note that `preduce` does not give the quotients in the division algorithm.

As you might expect, `groebner` stands for “Groebner basis,” and the syntax is:

```
6: groebner(polylist);
```

This computes a Groebner basis for the ideal generated by the polynomials in `polylist` with respect to the monomial ordering specified by `torder`. The answer is a reduced Groebner basis (in the sense of Chapter 2, §7), except for clearing denominators. As an example of how `groebner` works, consider the command:

```
7: gb := groebner ({x^2+y, 2*x*y+y^2});
```

This computes a list (and gives it the symbolic name `gb`) which is a Groebner basis for the ideal  $\langle x^2 + y, 2xy + y^2 \rangle \subset \mathbb{Q}[x, y]$ , using the term order specified by `torder`.

If you use polynomials with integer or rational coefficients in `preduce` or `groebner`, Groebner will assume that you are working over the field  $\mathbb{Q}$ . There is no limitation on the size of the coefficients. Another possible coefficient field is the Gaussian rational numbers  $\mathbb{Q}(i) = \{a + bi : a, b \in \mathbb{Q}\}$ , where  $i = \sqrt{-1}$ . To work over  $\mathbb{Q}(i)$ , you need to issue the command:

```
8: on complex;
```

before computing the Groebner basis (note that REDUCE uses `I` to denote  $\sqrt{-1}$ ). Similarly, to compute a Groebner basis over a finite field with  $p$  elements (where  $p$  is a prime number), you first need to issue the command:

```
9: on modular; setmod p;
```

To return to working over  $\mathbb{Q}$ , you would type `off modular`.

Groebner can also work with coefficients that lie in a rational function field. To tell Groebner that a certain variable is in the base field (a “parameter”), you simply omit it from the variable list in the `torder` command. Thus, the command:

```
10: groebner({v*x^2+y, u*x*y+y^2});
```

will compute a Groebner basis for  $\langle vx^2 + y, uxy + y^2 \rangle \subset \mathbb{Q}(u, v)[x, y]$  for the term order given by `torder`. The answer is reduced up to clearing denominators (so the leading coefficients of the Groebner basis are polynomials in  $u$  and  $v$ ).

The Groebner package has two switches which control how Groebner basis computations are done. (In REDUCE, a *switch* is a variable that can be set to `on` or `off`. Examples of switches you’ve already seen are `complex` and `modular`.) When computing a Groebner basis, there are a number of choices which can be made during the course of the algorithm, and different choices can have a dramatic effect on the length of the computation. We will describe two switches, `groebopt` and `gsugar`, which can affect how the `groebner` command carries out a computation.

In some cases, it is possible to improve efficiency by changing the order of the variables, though keeping the same term order (e.g., using `lex` with  $y > x$  rather than  $x > y$ ). An algorithm for doing this is described in BOEGE, GEBAUER and KREDEL (1986), and to enable this feature in REDUCE, you give the command:

```
11: on groebopt;
```

Once the calculation is done, you can determine how the variables were ordered by typing:

```
12: gvarslast;
```

This will print out the variables in the order used in the computation. There are some cases (especially when doing elimination) when you don’t want an arbitrary reordering of the variables. In this situation, you can use the `depend` command. For example, if you have variables  $s, t, x, y, z$  and you want to eliminate  $s, t$ , then after giving the `on groebopt` command, you would also type:

```
13: depend s, x, y, z; depend t, x, y, z;
```

With this preparation, the `groebner` command would reorder the variables, but always keeping  $s, t$  before  $x, y, z$ .

The algorithm used by the `groebner` command uses the concept of `sugar`, which was mentioned briefly in Chapter 2, §9. To experiment with the effect of `sugar`, you can turn it on or off by means of the switch `gsugar`. The default is `on gsugar`, so that to turn off `sugar` for a particular computation, you would issue the command `off gsugar` before giving the `groebner` command.

We should also mention the switches `groebstat`, `trgroeb` and `trgroeb`s for the `groebner` command which print out statistics about the Groebner basis calculation. These switches are described in Section 4.2 of MELENK, MÖLLER and NEUN (1994).

Some other useful commands in the Groebner package are:

- `gsplit`, which computes  $LT(f)$  and  $f - LT(f)$ .
- `gsort`, which prints out the terms of a polynomial according to the term order.
- `gspoly`, which computes an S-polynomial  $S(f, g)$ .

- `greduce`, which computes the remainder on division by the Groebner basis of the ideal generated by the input polynomials.
- `preducat`, which can be used to find the quotients in the division algorithm.
- `gzerodim?`, which tests a Groebner basis (using the methods of Chapter 5, §3) to see if the equations have finitely many solutions over an algebraically closed field.
- `glexconvert`, which, for a Groebner basis for an arbitrary monomial order with finitely many solutions over  $\mathbb{C}$ , converts it to a lex Groebner basis. This implements the algorithm discussed in Project 5 of Appendix D.
- `groesolve`, which attempts to find all solutions of a system of polynomial equations.
- `idealquotient`, which computes an ideal quotient  $I : f$  (using an algorithm more efficient than the one described in Chapter 4, §4).
- `hilbertpolynomial`, which computes the affine Hilbert polynomial of an ideal (as defined in Chapter 9, §3).

These (and many other) commands are described in detail in *Groebner: A package for calculating groebner bases* by MELENK, MÖLLER and NEUN (1994). This document comes with all copies of REDUCE.

## *Cali*

We will discuss Version 2.2.1 of the Cali package. Cali is more mathematically sophisticated than the Groebner package and is a little harder to use for the beginner. On the other hand, it can also do some computations (such as radicals and primary decomposition) which aren't part of the Groebner package. To load Cali, use the command:

```
1: load_package cali;
```

Don't load Groebner and Cali in the same REDUCE session since there are conflicts between them.

In Cali, you first have to declare the variables and monomial order before typing in any polynomials. This is done by the `setring` command, which has the syntax:

```
2: setring(vars, weight, order);
```

Here, `vars` is the list of variables you will use, `weight` is a list of weight vectors (possibly empty), and `order` is one of `lex` or `revlex`. For example:

```
3: setring({x, y, z}, {}, lex);
```

will give lex order on  $\mathbb{Q}[x, y, z]$ , while:

```
4: setring({x, y, z}, {{1, 1, 1}}, lex);
```

gives `grlex` on the same ring, and you can get `grevlex` simply by changing `lex` to `revlex` in the last command. One can also get weight orders, elimination orders and matrix orders as described in Exercise 12 of Chapter 2, §4. See Section 2.1 of GRÄBE (1995) for the details of how monomial orders work in Cali.

Once the ring is established, you can define ideals using lists of polynomials. One difference is that you must explicitly name the ideal. For example, suppose we let `j` denote the ideal generated by  $x^2 + y$  and  $x + 2xy$ . In Cali, this is done by the command:

```
5: setideal(j, {x^2+y, x+2*x*y});
```

Once we know the ideal, we can do various things with it. For example, to divide  $x^3 + 3y^2$  by  $x^2 + y$  and  $x + 2xy$ , we use the command:

```
6: x^3+3*y^2 mod j;
```



Also, to compute a Groebner basis of this ideal, the command to use is:

```
7: gbasis j;
```

The output is a Groebner basis for  $\langle x^2 + y, x + 2xy \rangle \subset \mathbb{Q}[x, y]$  for the monomial order set by the `setring` command. The answer is reduced (in the sense of Chapter 2, §7), except for clearing denominators.

If you use polynomials with integer or rational coefficients, Cali will assume that you are working over the field  $\mathbb{Q}$ . To compute Groebner bases over a finite field, you use the same commands as for the Groebner package described earlier in this section. Finally, for coefficients that lie in rational function fields, one proceeds as with the Groebner package and simply omits the variables in the base field when giving the `setring` command. For example, if we use the ring set in 4: above, then the commands:

```
8: setideal(m, {v*x^2+y, u*x*y+y^2});
```

```
9: gbasis m;
```

will compute a Groebner basis for  $\langle vx^2 + y, uxy + y^2 \rangle \subset \mathbb{Q}(u, v)[x, y]$  for grlex with  $x > y$ . The answer is reduced up to clearing denominators (so the leading coefficients of the Groebner basis are polynomials in  $u$  and  $v$ ).

Some other useful commands in Cali are:

- `dimzerop`, which tests a Groebner basis (using the methods of Chapter 5, §3) to see if the equations have finitely many solutions over an algebraically closed field.
- `dim`, which for a Groebner basis for an ideal computes the dimension of the associated variety.
- `idealquotient`, which computes an ideal quotient  $I : f$ .
- `isprime`, which tests a Groebner basis to see if it generates a prime ideal.
- `radical`, which computes the radical of an ideal.
- `primarydecomposition`, which computes the primary decomposition (as in Chapter 4, §7) of an ideal.

In addition, Cali has commands for dealing with more sophisticated mathematical objects such as modules, blowups, free resolutions and tangent cones. Details of these commands are described in *CALI: A REDUCE package for commutative algebra* by GRÄBE (1995).

## §5 Other Systems

Besides the general computer algebra systems discussed so far, there are three more specialized programs, Macaulay 2, CoCoA, and SINGULAR which should be mentioned. These programs were designed primarily for researchers in algebraic geometry and commutative algebra, but less sophisticated users can make effective use of either program. One of their most attractive features is that they are free.

It is a bit more complicated to get started with Macaulay 2, CoCoA or SINGULAR. For example, you have to tell the program in advance what the variables are and what field you are working over. This makes it more difficult for a novice to use Macaulay. Nevertheless, with proper guidance, beginning users should be able to work quite successfully with these programs.

Macaulay 2, CoCoA and SINGULAR give you a choice of working over  $\mathbb{Q}$  or a finite field. Over a finite field, some computations go considerably faster. As long as the coefficient size doesn't exceed the characteristic of the field (which is usually the case in simple examples), there is no problem. However, one must exercise some care in dealing with more complicated problems. This drawback must be weighed against the fact that such problems are often difficult to carry out on other systems because of the extremely large amount of memory that may be required.

For more advanced users, Macaulay 2, CoCoA and SINGULAR offer a wonderful assortment of sophisticated mathematical objects to work with. Many researchers make frequent use of these programs to compute syzygies and free resolutions of modules. Macaulay 2 also includes scripts for computing blowups, cohomology, cotangent sheaves, dual varieties, normal cones, radicals and many other useful objects in algebraic geometry. These programs are available electronically:

- <http://www.math.uiuc.edu/Macaulay2/> for Macaulay 2.
- <http://cocoa.dima.unige.it/> for CoCoA.
- <http://www.singular.uni-kl.de/> for SINGULAR.

In addition to the computer algebra systems described above, there are other systems worth mentioning:

- The system MAS is another computer algebra system available electronically. Besides computing Groebner bases as usual, it can also compute comprehensive Groebner bases and Groebner bases over principal ideal domains (as described in Project 16 of Appendix D). Instructions for obtaining MAS can be found on page xiii of BECKER and WEISPFENNING (1993).
- The computer algebra system Magma can do computations in group theory, number theory, combinatorics and commutative algebra. More information about Magma can be found at the web site:

<http://magma.maths.usyd.edu.au/magma/>

This list of computer algebra systems for working with Groebner bases is far from complete. As computers get faster and computer algebra software gets more powerful and easier to use, we can expect an ever-increasing range of applications for Groebner bases and algebraic geometry in general.

# Appendix D

## Independent Projects

Unlike the rest of the book, this appendix is addressed to the instructor. We will discuss several ideas for computer projects or research papers based on topics introduced in the text.

### §1 General Comments

Independent projects can be valuable for a variety of reasons:

- The projects get the students to actively understand and apply the ideas presented in the text.
- The projects expose students to the next steps in subjects discussed in the text.
- The projects give students more experience and sophistication as users of computer algebra systems.

Projects of this type are also excellent opportunities for small groups of two or three students to work together and learn collaboratively.

Some of the projects given below have a large computer component, whereas others are more theoretical. The list is in no way definitive or exhaustive, and users of the text are encouraged to contact the authors with comments or suggestions concerning these or other projects they have used.

The description we give for each project is rather brief. Although references are provided, some of the descriptions would need to be expanded a bit before being given to the student.

### §2 Suggested Projects

1. **Implementing the Division Algorithm in  $k[x_1, \dots, x_n]$ .** Many computer algebra systems (including REDUCE and Maple) have some sort of “normal form” or “reduce” command that performs a form of the division algorithm from Chapter 2. However, those commands usually display only the remainder. Furthermore, in some cases, only certain monomial orders are allowed. The assignment here would be for the students to implement the general division algorithm, with input a polynomial  $f$ , a list of divisors  $F$ , a list of variables  $X$ , and a monomial ordering.

The output would be the quotients and the remainder. This project would probably be done within a computer algebra system such as Maple or Mathematica.

2. **Implementing Buchberger's Algorithm.** Many computer algebra systems have commands that compute a reduced Groebner basis of an ideal  $\langle f_1, \dots, f_s \rangle$ . This project would involve implementing the algorithm in a way that produces more information and (possibly) allows more monomial orderings to be used. Namely, given the input of a list of polynomials  $F$ , a list of variables  $X$ , and a monomial order in  $k[x_1, \dots, x_n]$ , the program should produce a reduced Groebner basis  $G$  for the ideal generated by  $F$ , together with a matrix of polynomials  $A$  expressing the elements of the Groebner basis in terms of the original generators  $G = AF$ . As with the previous project, this would be done within a computer algebra system. The program could also give additional information, such as the number of remainders computed at each stage of the algorithm.
3. **The Complexity of the Ideal Membership Problem.** In §9 of Chapter 2, we briefly discussed some of the worst-case complexity results concerning the computation of Groebner bases and solving the ideal membership problem. The purpose of this project would be to have the students learn about the Mayr and Meyer examples, and understand the *double exponential* growth of degree bounds for the ideal membership problem. A suggested reference here is BAYER and STILLMAN (1988) which gives a nice exposition of these results. With some guidance, this paper is accessible reading for strong undergraduate students.
4. **Solving Polynomial Equations.** For students with some exposure to numerical techniques for solving polynomial equations, an excellent project would be to implement the criterion given in Theorem 6 of Chapter 5, §3 to determine whether a system of polynomial equations has only finitely many solutions over  $\mathbb{C}$ . If so, the program should determine all the solutions to some specified precision. This would be done by using numerical techniques to solve for one variable at a time from a lexicographic Groebner basis. A comparison between this method and more standard methods such as the multivariable Newton's Method could also be made. As of this writing, very little theoretical work comparing the complexity of these approaches has been done.
5. **Groebner Basis Conversion for Zero-Dimensional Ideals.** As in the previous project, to solve systems of equations, lexicographic Groebner bases are often the most useful bases because of their desirable elimination properties. However, lexicographic Groebner bases are often more difficult to compute than Groebner bases for other monomial orderings. For zero-dimensional ideals (i.e.,  $I \subset \mathbb{C}[x_1, \dots, x_n]$  such that  $\mathbf{V}(I)$  is a finite set), there are methods known for *converting* a Groebner basis with respect to some other order into a lexicographic Groebner basis. For this project, students would learn about these methods, and possibly implement them. There is a good introductory discussion of these ideas in HOFFMANN (1989). The original reference is FAUGÈRE, GIANNI, LAZARD, and MORA (1993). See also Chapter 2 of COX, LITTLE and O'SHEA (1998).
6. **Curve Singularities.** A multitude of project topics can be derived from the general topic of curve singularities, which we mentioned briefly in the text. Implementing an algorithm for finding the singular points of a curve  $\mathbf{V}(f(x, y)) \subset \mathbb{R}^2$  or  $\mathbb{C}^2$  could

be a first part of such a project. The focus of the project would be for students to learn some of the theoretical tools needed for a more complete understanding of curve singularities: the Newton polygon, Puiseux expansions, resolutions by quadratic transformations, etc. A good general reference for this would be BRIESKORN and KNÖRRER (1986). There are numerous other treatments in texts on algebraic curves as well. Some of this material is also discussed from the practical point of view of “curve tracing” in HOFFMANN (1989).

7. **Surface Intersections.** The focus of this project would be algorithms for obtaining equations for plane projections of the intersection curve of two surfaces  $\mathbf{V}(f_1(x, y, z)), \mathbf{V}(f_2(x, y, z))$  in  $\mathbb{R}^3$ . This is a very important topic in geometric modeling. One method, based on finding a “simple” surface in the pencil defined by the two given surfaces and which uses the projective closures of the two surfaces, is sketched in HOFFMANN (1989). Another method is discussed in GARRITY and WARREN (1989).
8. **Bézier Splines.** The Bézier cubics introduced in Chapter 1, §3 are typically used to describe shapes in geometric modeling as follows. To model a curved shape, we divide it into some number of smaller segments, then use a Bézier cubic to match each smaller segment as closely as possible. The result is a *piecewise* Bézier curve, or Bézier spline. For this project, the goal would be to implement a system that would allow a user to input some number of control points describing the shape of the curve desired and to see the corresponding Bézier spline curve displayed. Another interesting portion of this assignment would be to implement an algorithm to determine the *intersection points* of two Bézier splines. Some references can be found on p. xvi of FARIN (1990). We note that there has also been some recent theoretical work by BILLERA and ROSE (1989) that applies Groebner basis methods to the problem of determining the vector space dimension of multivariate polynomial splines of a given degree on a given polyhedral decomposition of a region in  $\mathbb{R}^n$ . See also Chapter 8 of COX, LITTLE and O’SHEA (1998).
9. **The General Version of Wu’s Method.** In our discussion of Wu’s method in geometric theorem proving in Chapter 6, we did not introduce the general algebraic techniques (characteristic sets, Ritt’s decomposition algorithm) that are needed for a general theorem-prover. This project would involve researching and presenting these methods. Implementing them in a computer algebra system would also be a possibility. See CHOU (1988), MISHRA (1993), WANG (1994a) and (1994b), and WU (1983).
10. **Molien’s Theorem.** An interesting project could be built around Molien’s Theorem in invariant theory, which is mentioned in §3 of Chapter 7. The algorithm given in STURMFELS (1993) could be implemented to find a set of generators for  $k[x_1, \dots, x_n]^G$ . This could be applied to find the invariants of some larger groups, such as the rotation group of the cube in  $\mathbb{R}^3$ . Molien’s theorem is also discussed in Chapter 7 of BENSON and GROVE (1985).
11. **Groebner Bases over More General Fields.** For students who know some field theory, a good project would be to compute Groebner bases over fields other than  $\mathbb{Q}$ . For example, one can compute Groebner bases for polynomials with coefficients in  $\mathbb{Q}(i)$  using the variable  $i$  and the equation  $i^2 + 1 = 0$ . More generally, if  $\mathbb{Q}(\alpha)$  is

any finite extension of  $\mathbb{Q}$ , the same method works provided one knows the minimal polynomial of  $\alpha$  over  $\mathbb{Q}$ . The needed field theory may be found in Sections 5.1, 5.3, and 5.5 of HERSTEIN (1975). The more advanced version of this project would discuss Groebner bases over finite extensions of  $\mathbb{Q}(u_1, \dots, u_m)$ . In this way, one could compute Groebner bases over any finitely generated extension of  $\mathbb{Q}$ .

12. **Computer Graphics.** In §1 of Chapter 8, we used certain kinds of projections when we discussed how to draw a picture of a 3-dimensional object. These ideas are very important in computer graphics. The student could describe various projections that are commonly used in computer graphics and explain what they have to do with projective space. If you look at the formulas in Chapter 6 of FOLEY, VAN DAM, FEINER and HUGHES (1990), you will see certain  $4 \times 4$  matrices. This is because points in  $\mathbb{P}^3$  have four homogeneous coordinates!
13. **Implicitization via Resultants.** As mentioned in Chapter 3, §3, implicitization can be done using resultants rather than Groebner bases. A nice project would be to report on the papers ANDERSON, GOLDMAN and SEDERBERG (1984a) and (1984b), and MANOCHA (1992). The resultants used in these papers differ from the resultants discussed in Chapter 3, where we defined the resultant of two polynomials. For implicitization, one needs the resultant of three or more polynomials, often called *multipolynomial resultants*. These resultants are discussed in BAJAJ, GARRITY and WARREN (1988) and Cox, LITTLE and O'SHEA (1998).
14. **Optimal Variable Orderings.** There are situations where reordering the variables (but keeping the same type of term order) can have a strong effect on the Groebner basis produced. For example, in part (a) of Exercise 13 from Chapter 2, §9, you computed a rather complicated Groebner basis using lex order with  $x > y > z$ . However, switching the variables to  $z > y > x$  (still with lex order) leads to a much simpler Groebner basis. A heuristic algorithm for picking an optimal ordering of the variables is described in BOEGE, GEBAUER and KREDEL (1986). A good project would be to implement a straightforward version of the Buchberger algorithm which incorporates variable optimization. This algorithm is implemented in the REDUCE Groebner basis package—see Appendix C, §4.
15. **Selection Strategies in the Buchberger's Algorithm.** In the discussion following the improved Buchberger algorithm (Theorem 11 in Chapter 2, §9), we mentioned the selection strategy of choosing a pair  $(i, j) \in B$  in Theorem 11 such that  $\text{LCM}(\text{LT}(f_i), \text{LT}(f_j))$  is as small as possible. This is sometimes called the *normal selection strategy*. However, there are other selection strategies which are used in practice, and a nice project would be to describe (or implement) one of these strategies. Here are two that are of interest:
  - a. The concept of *sugar* was introduced in GIOVINI, MORA, NIESI, ROBBIANO and TRAVERSO (1991). This paper explains why the normal selection strategy can cause problems with non-graded monomial orders (such as lex) and defines the concept of sugar to get around this problem. Sugar is implemented in the Groebner basis commands used by most of the computer algebra systems described in Appendix C.
  - b. In the special case of lex order, some other heuristics for selecting pairs are discussed in CZAPOR (1991). Here, the basic idea is to pick a pair  $(i, j)$  such that the multidegree of the S-polynomial  $S(f_i, f_j)$  is as small as possible.

16. **Other Types of Groebner Bases.** In Chapter 2, we defined Groebner bases for an ideal in a polynomial ring, assuming we knew the monomial order and the coefficient field. But there are other notions of what it means to be a Groebner basis, and a good project would be for a student to explore one of these. Here are some of the more interesting types of Groebner bases:
- We have seen that different monomial orderings can lead to different Groebner bases. As you vary over all monomial orderings, it turns out that there are only finitely many distinct Groebner bases for a given ideal. These can be put together to form what is called a *universal Groebner basis*, which is a Groebner basis for *all possible* monomial orders. A good reference (including references to the literature) is pages 514–515 of BECKER and WEISPFENNING (1993).
  - Another phenomenon (mentioned in Chapter 6, §3) is that if the base field contains parameters, then a Groebner basis over this field may fail to be a Groebner basis when we specialize the parameters to specific values. However, it is possible to construct a Groebner basis which remains a Groebner basis under *all possible* specializations. This is called a *comprehensive Groebner basis*. For a description and references to the literature, see pages 515–518 of BECKER and WEISPFENNING (1993).
  - Besides doing Groebner bases over fields, it is sometimes possible to define and compute Groebner bases for ideals in a polynomial ring  $R[x_1, \dots, x_n]$ , where  $R$  is a ring. The nicest case is where  $R$  is a principal ideal domain (PID), as defined in Chapter 1, §5. The basic theory of how to do this is described in Chapter 4 of ADAMS and LOUSTAUNAU (1994) and Section 10.1 of BECKER and WEISPFENNING (1993).
  - Finally, the notion of an ideal  $I \subset k[x_1, \dots, x_n]$  can be generalized to a *module*  $M \subset k[x_1, \dots, x_n]^r$ , and there is a natural way to define term orders and Groebner bases for modules. Basic definitions and interesting applications can be found in ADAMS and LOUSTAUNAU (1994), BECKER and WEISPFENNING (1993), COX, LITTLE and O'SHEA (1998), and EISENBUD (1995).

Besides the projects listed above, there are other places where instructors can look for potential projects for students, including the following:

- COX, LITTLE and O'SHEA (1998) includes chapters on local rings, algebraic coding theory and integer programming which could serve as the basis for projects. Other chapters in the book may also be suitable, depending on the interests of the students.
- ADAMS and LOUSTAUNAU (1994) contains sections on minimal polynomials of field extensions, the 3-color problem and integer programming. These could form the basis for some interesting projects.
- EISENBUD (1995) has a list of seven projects in Section 15.12. These projects are more sophisticated and require more background in commutative algebra, but they also introduce the student to some topics of current interest in algebraic geometry.

If you find student projects different from the ones listed above, we would be interested in hearing about them. There are a *lot* of wonderful things one can do with Groebner bases and algebraic geometry, and the projects described in this appendix barely scratch the surface.

# References

- W. Adams and P. Loustau (1994), *An Introduction to Gröbner Bases*, Graduate Studies in Mathematics **3**, AMS, Providence.
- D. Anderson, R. Goldman and T. Sederberg (1984a), *Implicit representation of parametric curves and surfaces*, Computer Vision, Graphics, and Image Design **28**, 72–84.
- D. Anderson, R. Goldman and T. Sederberg (1984b), *Vector elimination: a technique for the implicitization, inversion and intersection of planar parametric rational polynomial curves*, Computer Aided Geometric Design **1**, 327–356.
- M. F. Atiyah and I. G. MacDonald (1969), *Introduction to Commutative Algebra*, Addison-Wesley, Reading, Massachusetts.
- J. Baillieul et al. (1990), *Robotics*, Proceedings of Symposia in Applied Mathematics **41**, American Mathematical Society, Providence, Rhode Island.
- C. Bajaj, T. Garrity and J. Warren (1988), *On the applications of multi-equational resultants*, Technical Report CSD-TR-826, Department of Computer Science, Purdue University.
- A. A. Ball (1987), *The parametric representation of curves and surfaces using rational polynomial functions*, in *The Mathematics of Surfaces, II*, edited by R. R. Martin, Clarendon Press, Oxford, 39–61.
- D. Bayer (1982), *The division algorithm and the Hilbert scheme*, Ph.D. thesis, Harvard University.
- D. Bayer and D. Mumford (1993), *What can be computed in algebraic geometry?*, in *Computational Algebraic Geometry and Commutative Algebra*, edited by D. Eisenbud and L. Robbiano, Cambridge University Press, Cambridge, 1–48.
- D. Bayer and M. Stillman (1987a), *A criterion for detecting  $m$ -regularity*, Invent. Math. **87**, 1–11.
- D. Bayer and M. Stillman (1987b), *A theorem on refining division orders by the reverse lexicographic order*, Duke J. Math. **55**, 321–328.
- D. Bayer and M. Stillman (1988), *On the complexity of computing syzygies*, in *Computational Aspects of Commutative Algebra*, edited by L. Robbiano, Academic Press, New York, 1–13.
- T. Becker and V. Weispfenning (1993), *Gröbner Bases*, Springer-Verlag, New York-Berlin-Heidelberg.
- D. Benson (1993), *Polynomial Invariants of Finite Groups*, Cambridge University Press, Cambridge.
- C. T. Benson and L. C. Grove (1985), *Finite Reflection Groups*, Second Edition, Springer-Verlag, New York-Berlin-Heidelberg.
- L. Billera and L. Rose (1989), *Gröbner basis methods for multivariate splines*, in *Mathematical Methods in Computer Aided Geometric Design*, edited by T. Lyche and L. Schumacher, Academic Press, New York, 93–104.



- W. Boege, R. Gebauer and H. Kredel (1986), *Some examples for solving systems of algebraic equations by calculating Groebner bases*, J. Symbolic Comput. **2**, 83–98.
- E. Brieskorn and H. Knörrer (1986), *Plane Algebraic Curves*, Birkhäuser, Basel-Boston-Stuttgart.
- J. W. Bruce and P. J. Giblin (1992), *Curves and Singularities*, Second edition, Cambridge University Press, Cambridge.
- B. Buchberger (1985), *Groebner bases: an algorithmic method in polynomial ideal theory*, in *Multidimensional Systems Theory*, edited by N. K. Bose, D. Reidel Publishing Company, Dordrecht, 184–232.
- J. Canny and D. Manocha (1992), *Algorithm for implicitizing rational parametric surfaces*, Computer Aided Geometric Design **9**, 25–50.
- J. Canny and D. Manocha (1993), *Multipolynomial resultant algorithms*, J. Symbolic Comput. **15**, 99–122.
- B. Char, K. Geddes, G. Gonnet, B. Leong, M. Monogan, and S. Watt (1991), *Maple V Library Reference Manual*, Springer-Verlag, New York-Berlin-Heidelberg.
- S.-C. Chou (1988), *Mechanical Geometry Theorem Proving*, D. Reidel Publishing Company, Dordrecht.
- H. Clemens (1980), *A Scrapbook of Complex Curve Theory*, Plenum Press, New York/London.
- D. Cox, J. Little and D. O’Shea (1998), *Using Algebraic Geometry*, Springer-Verlag, New York-Berlin-Heidelberg.
- H. S. M. Coxeter (1973), *Regular Polytopes*, Third Edition, Dover, New York.
- S. Czapor (1991), *A heuristic selection strategy for lexicographic Gröbner bases?*, in *ISSAC 1991, Proceedings of the 1991 International Symposium on Symbolic and Algebraic Computation*, edited by S. Watt, ACM Press, New York, 39–48.
- J. H. Davenport, Y. Siret, and E. Tournier (1993), *Computer Algebra*, Second edition, Academic Press, New York.
- T. W. Dubé (1990), *The structure of polynomial ideals and Gröbner bases*, SIAM J. Comput. **19**, 750–775.
- D. Eisenbud (1995), *Commutative Algebra with a View Toward Algebraic Geometry*, Springer-Verlag, New York-Berlin-Heidelberg.
- D. Eisenbud, C. Huneke and W. Vasconcelos (1992), *Direct methods for primary decomposition*, Invent. Math. **110**, 207–235.
- G. Farin (1990), *Curves and Surfaces for Computer Aided Geometric Design*, Second Edition, Academic Press, New York.
- J. Faugère, P. Gianni, D. Lazard, and T. Mora (1993), *Efficient change of ordering for Gröbner bases of zero-dimensional ideals*, J. Symbolic Comput. **16**, 329–344.
- D. T. Finkbeiner (1978), *Introduction to Matrices and Linear Transformations*, Third Edition, W. H. Freeman and Co., San Francisco.
- J. Foley, A. van Dam, S. Feiner, and J. Hughes (1990), *Computer Graphics: Principles and Practice*, Second Edition, Addison-Wesley, Reading, Massachusetts.
- W. Fulton (1969), *Algebraic Curves*, W. A. Benjamin, Inc., New York.
- T. Garrity and J. Warren (1989), *On computing the intersection of a pair of algebraic surfaces*, Computer Aided Geometric Design **6**, 137–153.
- C. F. Gauss (1876), *Werke*, Volume III, Königlichen Gesellschaft der Wissenschaften zu Göttingen, Göttingen.
- R. Gebauer and H. M. Möller (1988), *On an installation of Buchberger’s algorithm*, in *Computational Aspects of Commutative Algebra*, edited by L. Robbiano, Academic Press, New York, 141–152.

- I. Gelfand, M. Kapranov and A. Zelevinsky (1994), *Discriminants, Resultants and Multidimensional Determinants*, Birkhäuser, Boston.
- P. Gianni, B. Trager and G. Zacharias (1988), *Gröbner bases and primary decomposition of polynomial ideals*, in *Computational Aspects of Commutative Algebra*, edited by L. Robbiano, Academic Press, New York, 15–33.
- A. Giovini, T. Mora, G. Niesi, L. Robbiano and C. Taverso (1991), “One sugar cube, please,” or Selection strategies in the Buchberger algorithm, in *ISSAC 1991, Proceedings of the 1991 International Symposium on Symbolic and Algebraic Computation*, edited by S. Watt, ACM Press, New York, 49–54.
- M. Giusti and J. Heintz (1993), *La détermination des points isolés et de la dimension d'une variété algébrique peut se faire en temps polynomial*, in *Computational Algebraic Geometry and Commutative Algebra*, edited by D. Eisenbud and L. Robbiano, Cambridge University Press, Cambridge, 216–256.
- H.-G. Gräbe (1995), *CAL: A REDUCE package for commutative algebra, Version 2.2.1*, Universität Leipzig, Institut für Informatik.
- P. Griffiths (1989), *Introduction to Algebraic Curves*, Translations of Mathematical Monographs **76**, AMS, Providence.
- P. Gritzmann and B. Sturmfels (1993), *Minkowski addition of polytopes: computational complexity and applications to Gröbner bases*, *SIAM Journal of Discrete Mathematics* **6**, 246–269.
- G. Hermann (1926), *Der Frage der endlich vielen Schritte in der Theorie der Polynomideale*, *Math. Annalen* **95**, 736–788.
- I. N. Herstein (1975), *Topics in Algebra*, Second Edition, John Wiley & Sons, New York.
- D. Hilbert (1890), *Über die Theorie der algebraischen Formen*, *Math. Annalen* **36**, 473–534. Reprinted in *Gesammelte Abhandlungen*, Volume II, Chelsea, New York, 1965.
- D. Hilbert (1993), *Theory of Algebraic Invariants*, Cambridge University Press, Cambridge.
- W. V. D. Hodge and D. Pedoe (1968), *Methods of Algebraic Geometry*, Volumes I and II, Cambridge University Press, Cambridge.
- C. Hoffmann (1989), *Geometric and Solid Modeling: An Introduction*, Morgan Kaufmann Publishers, San Mateo, California.
- R. Jenks and R. Sutor (1992), *Axiom: the scientific computation system*, Springer-Verlag, New York-Berlin-Heidelberg.
- J. Jouanolou (1991), *Le formalisme du résultant*, *Advances in Math.* **90**, 117–263.
- K. Kendig (1977), *Elementary Algebraic Geometry*, Springer-Verlag, New York-Berlin-Heidelberg.
- F. Kirwan (1992), *Complex Algebraic Curves*, London Mathematical Society Student Texts **23**, Cambridge University Press, Cambridge.
- F. Klein (1884), *Vorlesungen über das Ikosaeder und die Auflösung der Gleichungen vom Fünften Grade*, Teubner, Leipzig. English Translation, *Lectures on the Icosahedron and the Solution of Equations of the Fifth Degree*, Trubner, London, 1888. Reprinted by Dover, New York, 1956.
- S. Lang (1965), *Algebra*, Addison-Wesley, Reading, Massachusetts.
- D. Lazard (1983), *Gröbner bases, Gaussian elimination and resolution of systems of algebraic equations*, in *Computer Algebra: EUROCAL 83*, edited by J. A. van Hulzen, Lecture Notes in Computer Science **162**, Springer-Verlag, New York-Berlin-Heidelberg, 146–156.
- D. Lazard (1993), *Systems of algebraic equations (algorithms and complexity)*, in *Computational Algebraic Geometry and Commutative Algebra*, edited by D. Eisenbud and L. Robbiano, Cambridge University Press, Cambridge, 84–105.
- M. Lejeune-Jalabert (1985), *Effectivité des calculs polynomiaux*, Cours de DEA 1984–85, Institut Fourier, Université de Grenoble I.

- F. Macaulay (1902), *On some formula in elimination*, Proc. London Math. Soc. **3**, 3–27.
- D. Manocha (1994), *Solving systems of polynomial equations*, IEEE Computer Graphics and Applications **14**, March 1994, 46–55.
- H. Matsumura (1986), *Commutative Ring Theory*, Cambridge University Press, Cambridge.
- E. Mayr and A. Meyer (1982), *The complexity of the word problem for commutative semigroups and polynomial ideals*, Adv. Math. **46**, 305–329.
- H. Melenk, H. M. Möller and W. Neun (1994), *Groebner: A package for calculating Groebner bases*, Konrad-Zuse-Zentrum für Informationstechnik, Berlin.
- M. Mignotte (1992), *Mathematics for Computer Algebra*, Springer-Verlag, New York-Berlin-Heidelberg.
- R. Mines, F. Richman, and W. Ruitenburg (1988), *A Course in Constructive Algebra*, Springer-Verlag, New York-Berlin-Heidelberg.
- B. Mishra (1993), *Algorithmic Algebra*, Texts and Monographs in Computer Science, Springer-Verlag, New York-Berlin-Heidelberg.
- H. M. Möller and F. Mora (1984), *Upper and lower bounds for the degree of Groebner bases*, in *EUROSAM 1984*, edited by J. Fitch, Lecture Notes in Computer Science **174**, Springer-Verlag, New York-Berlin-Heidelberg, 172–183.
- D. Mumford (1976), *Algebraic Geometry I: Complex Projective Varieties*, Springer-Verlag, New York-Berlin-Heidelberg.
- R. Paul (1981), *Robot Manipulators: Mathematics, Programming and Control*, MIT Press, Cambridge, Massachusetts.
- L. Robbiano (1986), *On the theory of graded structures*, J. Symbolic Comp. **2**, 139–170.
- L. Roth and J. G. Semple (1949), *Introduction to Algebraic Geometry*, Clarendon Press, Oxford.
- A. Seidenberg (1974), *Constructions in algebra*, Trans. Amer. Math. Soc. **197**, 273–313.
- A. Seidenberg (1984), *On the Lasker–Noether decomposition theorem*, Am. J. Math. **106**, 611–638.
- I. R. Shafarevich (1974), *Basic Algebraic Geometry*, Springer-Verlag, New York-Berlin-Heidelberg.
- L. Smith (1995), *Polynomial Invariants of Finite Groups*, A K Peters, Ltd., Wellesley, Massachusetts.
- B. Sturmfels (1989), *Computing final polynomials and final syzygies using Buchberger’s Gröbner bases method*, Results Math. **15**, 351–360.
- B. Sturmfels (1993), *Algorithms in Invariant Theory*, Texts and Monographs in Symbolic Computation, Springer-Verlag, New York-Vienna.
- B. van der Waerden (1931), *Moderne Algebra, Volume II*, Springer-Verlag, Berlin. English translations, *Modern Algebra, Volume II*, F. Ungar Publishing Co., New York, 1950; *Algebra, Volume 2*, F. Ungar Publishing Co., New York 1970; and *Algebra, Volume II*, Springer-Verlag, New York-Berlin-Heidelberg, 1991. The chapter on Elimination Theory is included in the first three German editions and the 1950 English translation, but all later editions (German and English) omit this chapter.
- R. Walker (1950), *Algebraic Curves*, Princeton University Press, Princeton. Reprinted by Dover, 1962.
- D. Wang (1994a), *An implementation of the characteristic set method in Maple*, in *Automated Practical Reasoning: Algebraic Approaches*, edited by J. Pfalzgraf and D. Wang, Springer-Verlag, New York-Vienna, 187–201.
- D. Wang (1994b), *Characteristic sets and zero structure of polynomial sets* (Revised version of May 1994), Lecture Notes, RISC-LINZ, Johannes Kepler University, Linz, Austria.

- F. Winkler (1984), *On the complexity of the Gröbner bases algorithm over  $K[x, y, z]$* , in *EUROSAM 1984*, edited by J. Fitch, Lecture Notes in Computer Science **174**, Springer-Verlag, New York-Berlin-Heidelberg, 184–194.
- S. Wolfram (1996), *The Mathematica Book*, Third Edition, Wolfram Media, Champaign, Illinois.
- W.-T. Wu (1983), *On the decision problem and the mechanization of theorem-proving in elementary geometry*, in *Automated Theorem Proving: After 25 Years*, edited by W. Bledsoe and D. Loveland, Contemporary Mathematics **29**, American Mathematical Society, Providence, Rhode Island, 213–234.

# Index

- Adams, W., 209, 534, 535  
admissible geometric theorem, 296  
affine  
  cone over a projective variety, *see* cone,  
  affine  
  Dimension Theorem, *see* Theorem,  
  Dimension  
  Hilbert function, *see* Hilbert function,  
  affine  
  Hilbert polynomial, *see* Hilbert  
  polynomial, affine  
  space, *see* space, affine  
  transformation, *see* transformation,  
  affine  
  variety, *see* variety, affine  
Agnesi, M., 25  
algebraic relation, 345  
algebraically independent, 299, 300,  
  477–79  
algorithm, 38, 146  
  algebra (subring) membership, 331, 336  
  associated primes, 213  
  Buchberger’s, 79, 88–91, 93–95, 102,  
  385, 531, 533  
  computation in  $k[x_1, \dots, x_n]/I$ , 230  
  consistency, 172  
  dimension (affine variety), 457, 477  
  dimension (projective variety), 452  
  division, 38, 161, 223  
  division in  $k[x_1, \dots, x_n]$ , 24, 315  
  Euclidean, 42, 154, 156, 160, 181  
  finiteness of solutions, 524  
  Gaussian elimination (row reduction), 9,  
  54, 93  
  greatest common divisor, 180, 190  
  ideal equality, 93  
  ideal intersection, 197  
  ideal membership, 35, 45, 95  
  ideal quotient, 194, 197  
  irreducibility, 209  
  least common multiple, 189  
  polynomial implicitization, 130  
  primality, 209  
  primary decomposition, 210–13  
  projective closure, 386  
  projective elimination, 393  
  pseudodivision, 307  
  radical, 240  
  radical membership, 178, 297  
  rational implicitization, 134  
  Ritt’s decomposition, 309, 314, 532  
  tangent cone, 490  
  Wu-Ritt, 314, 532  
altitude, 295–96  
Anderson, D., 134, 533, 535  
artificial intelligence, 291  
ascending chain condition (ACC), 78–79,  
  381, 400  
associated primes question, 209  
Atiyah, M., 212, 535  
automated geometric theorem proving,  
  291  
automorphism of varieties, 245  
AXIOM, *see* computer algebra systems,

- Baillieul, J.**, 287, 535  
**Bajaj, C.**, 159, 533, 535  
**Ball, A. A.**, 28, 535  
**Barrow, I.**, 25  
**basis**  
   Groebner, *see* Groebner basis  
   minimal, 36, 74  
   minimal Groebner, *see* Groebner basis,  
     minimal  
   of an ideal, *see* ideal, basis for  
   reduced Groebner, *see* Groebner basis,  
     reduced  
   standard, 77–78  
**Bayer, D.**, ix, 75, 112, 122, 520, 531, 535  
**Becker, T.**, 82–83, 111, 178, 188, 209, 236,  
   283, 529, 534–35  
**Benson, C. T.**, 329, 340, 342, 532, 535  
**Benson, D.**, 342, 535  
**Bernoulli, J.**, 25  
**Bézier, P.**, 21  
   cubic, *see* cubic, Bézier  
**Bezout's Theorem**, *see* Theorem, Bezout  
**bihomogeneous polynomial**, *see*  
   polynomial, bihomogeneous  
**Billera, L.**, 532, 535  
**birationally equivalent varieties**, 255, 481  
**blow-up**, 506–08  
**Boege, W.**, 526, 533, 536  
**Brieskorn, E.**, 434, 438, 532, 536  
**Bruce, J. W.**, 137, 143, 147, 536  
**Buchberger, B.**, 78–79, 85, 88, 102, 111,  
   230, 287, 536  
  
**Canny, J.**, 134, 159, 536  
**centroid**, 304  
**chain**  
   ascending, of ideals, 78–79  
   descending, of varieties, 81, 204, 381  
**characteristic of a field**, *see* field  
**characteristic sets**, 309, 314, 532  
**Chou, S.-C.**, 310, 532, 536  
**Circle Theorem of Apollonius**, *see*  
   Theorem, Circle, of Apollonius  
**circumcenter**, 304  
**cissoid of Diocles**, *see* curve, cissoid of  
   Diocles  
   classification of varieties, 220, 255  
**Classification Theorem for Quadrics**, *see*  
   Theorem, Classification, for  
   Quadrics  
**Clemens, H.**, 434, 536  
**closure**  
   projective, 389, 393, 403, 475  
   Zariski, 125, 193–94, 200, 258  
**Closure Theorem**, *see* Theorem, Closure  
**CoCoA**, *see* computer algebra systems  
**coefficient**, 1–2  
**collinear**, 293, 304  
**comaximal ideals**, 192  
**commutative ring**, *see* ring, commutative  
**complement of a monomial ideal**, 443  
**complete intersection**, 475  
**complexity**, 102, 111, 531,  
   computer algebra systems, 38, 40, 43,  
     45–46, 49, 59, 78, 93, 102, 137,  
     149, 153, 156, 166, 237, 282, 289,  
     307, 309, 465, 517–28,  
   AXIOM, 38, 178, 209, 213, 517–20  
   CoCoA, 465, 528  
   Macaulay, 178, 209, 465, 528  
   Maple, 38, 517  
   MAS, 529  
   Mathematica, 38, 517  
   REDUCE, 38, 172, 242, 280, 288, 290,  
     295, 297, 465  
   SCRATCHPAD, 517  
   SINGULAR, 247–48, 256, 282–91, 374,  
     528  
   computer graphics, 533  
   computer-aided geometric design (CAGD),  
     21–22  
**cone**, 7, 490  
   affine, 377, 383–84, 464, 468, 497, 499  
   projectivized tangent, 507  
   tangent, 490  
**configuration space**, *see* space,  
   configuration (of a robot)  
**congruence (mod  $I$ )**, 222  
**conic section**, 28, 137, 408, 411  
**consistency question**, 11, 46, 172  
**constructible set**, 127, 263–64

- control
  - points, 22
  - polygon, 22
- coordinate ring of a variety ( $k[V]$ ), *see*
  - ring, coordinate ( $k[V]$ )
- coordinate subspace, 440–43, 446–51, 454
  - translate of, 446, 449–51
- coordinates,
  - homogeneous, 357, 360
  - Plücker, 417ff, 421–22
- coset, 354
- Cox, D., 121, 159, 236, 522, 531–34, 536
- Coxeter, H. S. M., 329, 536
- Cramer's Rule, 157, 399, 512
- cross ratio, 304
- cube, 329, 334, 344
- cubic
  - Bézier, 21, 27, 532
  - twisted, *see* curve, twisted cubic
- curve
  - cissock of Diocles, 25–26
  - dual, 356
  - family of, 137, 142
  - folium of Descartes, 137
  - four-leaved rose, 12–13, 149
  - rational normal, 392
  - twisted cubic, 8, 19–20, 32–34, 37, 69, 100, 131, 135, 232, 248, 374–78, 390–92, 475–77
- cuspidal edge, 248
- Czapor, S., 533, 536
- Davenport, J. H.**, 40, 43, 46, 153, 190, 536
- decomposition
  - minimal, of a variety, 206–08, 443
  - minimal, of an ideal, 209
  - primary, 211
  - question, 209
- degenerate case of a geometric configuration, 297, 313
- degeneration, 438
- degree
  - of a projective variety, 476
  - total, of a monomial, 2, 440
  - total, of a polynomial, 2
  - transcendence, of a field extension, 482
- dehomogenization
  - of a polynomial, 493, 519
- derivative, formal, 47, 229, 493
- descending chain condition (DCC), 81, 204, 214
- desingularization, 508
- determinant, 155, 417, 511
  - Vandermonde, 46
- Dickson's Lemma, 69
- difference of varieties, 193
- dimension, 8–13, 24, 231–41, 255, 278, 284, 291, 362, 368–69, 439–43, 446–84, 487–95, 503
  - at a point, 490, 503
  - question, 11, 460ff
- discriminant, 160, 325
- divison algorithm, *see* algorithm, division
- dodecahedron, 335
- dominating map, 483
- dual
  - curve, 356
  - projective plane, 367, 408
  - projective space, 378, 417
  - variety, 356
- duality
  - of polyhedra, 334
  - projective principle of, 367
- Dubé, T., 111, 536
- Echelon matrix**, 51, 78, 93–95, 419, 422
- Eisenbud, D., 178, 209, 534–36
- elimination ideal, *see* ideal, elimination
- elimination order, *see* monomial ordering, elimination
- elimination step, 116
- Elimination Theorem, *see* Theorem, Elimination
- elimination theory, 18, 115
  - projective, 393
- envelope, 141
- equivalence
  - birational, 254–55, 481, 484
  - projective, 409–11, 416
- Euler line, 304
- Euler's Formula, 377
- extension step, 116

Extension Theorem, *see* Theorem, Extension

Factorization of polynomials, 150, 152, 180

family of curves, *see* curve, family of

Farin, G., 532, 536

Faugère, J., 531, 536

Feiner, S., 533, 536

Fermat's Last Theorem, *see* Theorem, Fermat's Last

fiber, 263

field, 1, 509

algebraically closed, 4, 35, 130, 165, 170–78, 202, 382–84, 469–474, 522

finite, 1, 5, 33

infinite, 3–4, 37, 130, 381, 502

of characteristic zero, 183, 327

of finite (positive) characteristic, 182, 309

of fractions of a domain, 249, 258

of rational functions, ( $k(V)$ ), 249, 280, 474, 480, 484, 519

final remainder (in Wu's method), 312

finite generation of invariants, 333, 339

finiteness question, 11, 207, 329, 522, 524

Finkbeiner, D. T., 161, 168, 413, 480, 511–12, 536

Foley, J., 533, 536

folium of Descartes, *see* curve, folium of Descartes

follows generically from, 300

follows strictly from, 297

forward kinematic problem, *see* kinematics problem of robotics, forward

Fulton, W., 433–34, 536

function

algebraic, 122

coordinate, 239

polynomial, 216–18, 220–21, 224, 239, 243, 449

rational, 15, 122, 249

function field, *see* field, of rational functions ( $k(V)$ )

Fundamental Theorem of Algebra, *see* Theorem, Fundamental, of Algebra

Fundamental, of Symmetric Functions, *see* Theorem, Fundamental, of Symmetric Function

Garrity, T., 159, 532–33, 535–36

Gauss, C. F., 320, 536

Gaussian elimination, *see* algorithm, Gaussian elimination (row reduction)

Gebauer, R., 111, 526, 533, 536

Gelfand, I., 159, 537

Geometric Extension Theorem, *see* Theorem, Geometric Extension

Gianni, P., 178, 209, 531, 536

Giblin, P. J., 137, 143, 147, 536

Giovini, A., 111, 533, 537

Giusti, M., 112, 537

$GL(n, k)$ , *see* group, general linear

Goldman, R., 134, 533, 535

Goldstine, S., 524

Gräbe, H.-G., 527, 537

graded lexicographic order, *see* monomial ordering

graded monomial order, *see* monomial ordering

graded reverse lexicographic order, *see* monomial ordering

gradient, 10, 140, 144

graph, 6, 129

Grassmannian, 419

greatest common divisor (GCD), 41, 180–82, 190

Griffiths, P., 434, 537

Gritzmann, P., 112, 537

Gröbner, W., 78

Groebner basis, 77–122, 130, 134–36, 172, 179, 188, 230–38, 280–83, 287–91, 302, 322–23, 346–49, 383, 385, 388, 391, 403–07, 497–99, 505, 517–28, 531–34

comprehensive, 283, 534

conversion, 520

criterion for, 82, 107

minimal, 91–94

reduced, 92–96, 111–13, 172, 179, 288, 383, 531



- specialization of, 280, 283, 287
- universal, 534
- group, 510
  - cyclic, 328
  - finite matrix, 327
  - general linear ( $GL(n, k)$ ), 327, 329, 345
  - generators for, 336
  - Klein four-, 332
  - of symmetries of a cube, 329, 334
  - of symmetries of a tetrahedron, 335
  - orbit of a point under, 351
  - permutation, 426, 511
  - projective general linear ( $PGL(n, k)$ ), 327, 329
  - subgroup of, 355
- Grove, L. C., 329, 340, 342, 532, 535
- Gryc, W., 522, 524
- Heintz, J.**, 112, 537
- Hermann, G., 178, 209, 537
- Herstein, I. N., 324, 533, 537
- Hilbert Basis Theorem, *see* Theorem, Hilbert Basis
- Hilbert function, 456–70
  - affine, 457–60, 466
- Hilbert polynomial, *see* polynomial, Hilbert
- Hilbert, D., 74, 76, 169–70, 175, 342, 443, 537
- Hironaka, H., 78
- Hodge, W. V. D., 419, 537
- Hoffmann, C., 531–32, 537
- homogeneous
  - coordinates, *see* coordinates, homogeneous
  - ideal, *see* ideal, homogeneous
  - polynomial, *see* polynomial, homogeneous
- homogenization
  - of a polynomial, 175, 373
  - of an ideal, 389, 497
- Hughes, J., 533, 536
- Huneke, C., 178, 209, 536
- hyperboloid, 251
- hyperplane, 369, 371, 410
  - at infinity, 371, 390
- hypersurface, 371, 474, 476
  - cubic, 371
  - nonsingular quadric, 414–20
  - quadric, 371, 408–14
  - quartic, 371
  - quintic, 371
- Icosahedron**, 335
- ideal, 29
  - $P$ -primary, 210
  - basis of, 31, 42
  - colon, 194
  - complete intersection, 475
  - determinantal, 113
  - elimination, 116–27, 397–408
  - generated by a set of polynomials, 30
  - Groebner basis of, *see* Groebner basis
  - homogeneous, 380–88, 405, 408
  - in a ring, 226
  - intersection of, 189, 214
  - irreducible, 210
  - maximal, 202
  - maximum principle, 264
  - monomial, 69–76, 439–443, 446–64, 467
  - of a variety ( $\mathbf{I}(V)$ ), 33, 50, 440
  - of leading terms ( $\langle \text{LT}(I) \rangle$ ), 75
  - of relations, 346
  - primary, 210
  - prime, 198–203, 207–214, 257–59, 489
  - principal, 41, 46, 81, 179–82, 189–91
  - product, 473
  - projective elimination, 397–408
  - proper, 201–03
  - quotient, 194, 397
  - radical, 37, 175–78, 182–83, 190–91, 207, 209–12, 226, 240
  - radical of, 174, 382
  - saturation, 198
  - standard basis of, *see* basis, standard
  - sum of, 183, 386
  - syzygy, 346
  - weighted homogeneous, 405
- ideal description question, 35, 49, 77

- ideal membership question, 35, 45, 61, 67–68, 83, 146, 531
- ideal-variety correspondence
  - affine, 193, 381
  - projective, 384
- Implicit Function Theorem, *see* Theorem, Implicit Function
- implicit representation, 16
- implicitization, 17, 128–34, 533
- Inclusion-Exclusion Principle, 450, 454
- index of regularity, 459, 466
- inflection point, *see* point, inflection
- integer polynomial, *see* polynomial, integer
- integral domain, *see* ring, integral domain
- invariance under a group, 332
- invariant polynomial, *see* polynomial, invariant
- inverse kinematic problem, *see* kinematics problem of robotics, inverse
- inverse lexicographic order, *see* monomial ordering
- irreducibility question, 209
- irreducible
  - ideal, *see* ideal, irreducible
  - polynomial, *see* polynomial, irreducible
  - variety, *see* variety, irreducible
- irredundant
  - intersection of ideals, 207
  - union of varieties, 206
- isomorphic
  - rings, 226
  - varieties, 220, 245, 247, 252, 479–80
- Isomorphism Theorem, *see* Theorem, Isomorphism
- isotropy subgroup, 355
- Jacobian matrix**, *see* matrix, Jacobian
- Jenks, R., 519, 537
- joint space, *see* space, joint (of a robot)
- joints (of robots)
  - ball, 267, 271
  - helical, 267, 270–71
  - prismatic, 266, 268, 274–75
  - revolute, 266–91
  - spin, 278, 290
- Jouanolou, J., 159, 537
- $k(V)$ , 474, 480
- $k(t_1, \dots, t_m)$ , 15
- $k[V]$ , 217–221, 224, 239
- $k[f_1, \dots, f_m]$ , 336
- $k[x_1, \dots, x_n]$ , 1–2
- Kapranov, M., 159, 537
- Kendig, K., 474, 491, 492, 537
- kinematics problem of robotics
  - forward, 268–279
  - inverse, 279–91
- kinematic redundancy, 291
- kinematic singularities, 282–86, 290, 291
- Kirwan, F., ix, 433–34, 537
- Klein four-group, *see* group, Klein four-
- Klein, F., 329, 332–33, 537
- Knörrer, H., 434, 438, 532, 536
- Kredel, H., 526, 533, 536
- Lagrange multipliers**, 10, 13, 97, 102
- Lang, S., 130, 482, 537
- Lasker–Noether Theorem, *see* Theorem, Lasker–Noether
- Lazard, D., 112–13, 121, 531, 537
- leading coefficient, 59
- leading monomial, 59
- leading term, 38, 57
- leading terms, ideal of, *see* ideal, of leading terms ( $\langle \text{LT}(I) \rangle$ )
- least common multiple (LCM), 83, 189
- Lejeune-Jalabert, M., ix, 537
- level set, 220
- lexicographic order, *see* monomial ordering
- Lin, A., 522
- line
  - affine, 3, 361
  - at infinity, 424
  - limit of, 499
  - projective, 358–61, 364–69, 371, 412
  - secant, 499
  - tangent, 138, 144
- Little, J., 121, 159, 236, 522, 531–34, 536
- local property, 433, 485
- locally constant, 433
- Loustaunau, P., 209, 522, 534–35

- Macaulay 2 (program), *see* computer algebra systems  
 Macaulay, F. S., 159, 458, 538  
 MacDonald, I. G., 212, 535  
 Magma, *see* computer algebra systems  
 manifold, 492  
 Manocha, D., 121, 134, 159, 533, 536, 538  
 Maple, *see* computer algebra systems  
 mapping, 415  
   dominating, 483  
   polynomial, 215  
   projection, 171, 216  
   pullback, 243, 254  
   rational, 251–52  
   regular, 216  
   Segre, 393  
   stereographic projection, 256  
 MAS, *see* computer algebra systems  
 Mathematica, *see* computer algebra systems  
 matrix  
   echelon, *see* echelon matrix  
   group, 327  
   Jacobian, 283–85  
   permutation, 328  
   row-reduced echelon, *see* echelon matrix  
   Sylvester, 155  
 Matsumura, H., 503, 538  
 Mayr, E., 111, 538  
 Melenk, H., 525, 527, 538  
 Meyer, A., 111, 538  
 Mignotte, M., 121, 153, 538  
 Mines, R., 153, 178, 209, 538  
 minimal basis, *see* basis, minimal  
 Mishra, B., 121, 314, 532, 538  
 mixed order, *see* monomial ordering  
 module, 528  
 Molien's Theorem, *see* Theorem, Molien's  
 Möller, H. M., 111, 525–26, 536  
 monomial, 1  
 monomial ordering, 55, 72, 380, 404, 520  
   elimination, 75, 122  
   graded, 388, 391  
   graded lexicographic (grlex), 56–57, 60, 76, 81, 134, 219, 520  
   graded reverse lexicographic (grevlex), 58–60  
   inverse lexicographic (invlex), 60  
   lexicographic (lex), 56–57, 94, 97, 107, 115, 117, 302, 322, 497  
   mixed, 74  
   product, 74  
   weight, 74  
 Mora, F., 111, 538  
 Mora, T., 111–13, 533, 536–37  
 multidegree (multideg), 59  
 multinomial coefficient, 343  
 multiplicity, 38  
   intersection, 139, 428–30, 433  
   of root, 47, 139–40, 148  
 Mumford, D., 112, 492, 502, 505, 506, 535, 538  
  
 Neun, W., 525, 527, 538  
 Newton identities, 324, 326–327  
 Newton polygon, 532  
 Newton's Method, 531  
 Niesi, G., 111, 533, 537  
 nilpotent, 226, 229  
 Noether's Theorem, *see* Theorem, Noether's  
 Noether, E., 338  
 nonsingular, 414–16  
   point, *see* point, nonsingular  
   quadric, *see* quadric, nonsingular  
 Normal Form for Quadrics Theorem, *see* Theorem, Normal Form for Quadrics  
 normal form, 82  
 Nullstellensatz, 35, 37, 47, 125, 169, 170, 177–78, 195, 234, 236, 240–41, 302, 379, 384, 391, 435, 489, 498  
   Hilbert's, 4, 169–175  
   in  $k[V]$ , 240–41  
   Projective Strong, 385  
   Projective Weak, 383–84, 398–400  
   Strong, 176–77, 298, 305, 382–84  
   Weak, 170–73, 202–03, 234, 382, 398  
 numerical solutions, 121

- O'Shea, D.**, 121, 159, 236, 522, 531–34, 536  
 octahedron, 335  
 operational space, *see* space, configuration (of a robot)  
 orbit  
    $G$ , 351, 353  
   of a point, 353  
   space, 351, 353  
 order (of a group), 328  
 ordering, *see* monomial ordering  
 orthocenter, 304  
  
**Pappus's Theorem**, *see* Theorem, Pappus's  
 parametric representation, 15–17, 215  
   polynomial, 16, 196, 239  
   rational, 15, 17, 132  
 parametrization, 15  
 partial solution, 117, 123  
 path connected, 433, 436  
 Paul, R., 287, 538  
 Pedoe, D., 419, 537  
 pencil  
   of hypersurfaces, 378  
   of lines, 368  
   of surfaces, 241  
   of varieties, 241, 378  
 permutation, 511  
   sign of, 511  
 perspective, 358, 362, 364, 367  
 $PGL(n, k)$ , *see* group, projective general linear  
 plane  
   affine, 3  
   Euclidean, 292  
   projective, 357  
 Plücker coordinates, *see* coordinates, Plücker  
 point  
   critical, 100–01  
   nonsingular, 141, 146, 433, 485, 489, 491–92, 495, 503  
   of inflection, 148  
   singular, 137–41, 146–50, 247, 356, 374, 489–92, 495–96, 531  
   smooth, 506  
   Steiner, 306  
   vanishing, 358–59  
 polyhedron  
   duality, 334  
   regular, 329  
 polynomial, 2  
   affine Hilbert, 457, 459–60, 466–67, 471, 475–77, 479, 527  
   bihomogeneous, 405  
   elementary symmetric, 320–21  
   Hilbert, 459–60, 462–63, 465, 467, 475–77  
   homogeneous, 174, 323, 370  
   homogeneous component of, 323  
   integer, 156  
   invariant, 324  
   irreducible, 150  
   linear part, 486  
   Newton-Gregory interpolating, 455  
   partially homogeneous, 395  
   reduced, 47, 92–93, 180  
    $S$ -, 84–90, 102–109, 111, 188, 288, 519, 522, 526, 533  
   square-free, 47, 180  
   symmetric, 317  
   weighted homogeneous, 405, 407  
 Polynomial Implicitization Theorem, *see* Theorem, Polynomial Implicitization  
 polynomial mapping, *see* mapping, polynomial  
 polynomial ring ( $k[x_1, \dots, x_n]$ ), *see* ring, polynomial  
 PostScript, 22  
 power sums, 323  
 primality question, 209  
 primary decomposition question, 213  
 principal ideal domain (PID), 41, 165, 534  
 product order, *see* monomial ordering  
 projective  
   closure, *see* closure, projective  
   elimination ideal, *see* ideal, projective elimination  
   elimination  
   equivalence, *see* equivalence, projective  
   Extension Theorem, *see* Theorem, Projective Extension

- line, *see* line, projective
- plane, *see* plane, projective
- space, *see* space, projective
- variety, *see* variety, projective
- pseudocode, 38, 513
- pseudodivision, 260, 307
  - successive, 310
- pseudoquotient, 308
- pseudoremainder, 308
- Puiseux expansions, 532
- pullback mapping, *see* mapping, pullback
- pyramid of rays, 362
- Quadric hypersurface**, 357, 371, 408
  - nonsingular, 414
  - over  $\mathbb{R}$ , 414
  - rank of, 413
- quotient
  - field, *see* field, of fractions
  - ring, *see* ring, quotient
  - vector space, 457
- quotients on division, 46
- R-sequence**, 475
- radical
  - generators of, 178
  - ideal, *see* ideal, radical
  - membership, *see* algorithm, radical membership
  - of an ideal, *see* ideal, radical of
- rank
  - deficient, 284
  - maximal, 284
  - of a matrix, 284, 413
  - of a quadric, 413
- rational
  - function, *see* function, rational
  - mapping, *see* mapping, rational
  - variety, *see* variety, rational
- Rational Implicitization Theorem, *see* Theorem, Rational Implicitization
- real projective plane, 368
- REDUCE, *see* computer algebra systems
- reduction of a polynomial,
- regular mapping, *see* mapping, regular
- regularity, index of, *see* index of regularity
- remainder on division, 67–69, 82–83, 85, 89–90, 96, 162, 230, 321, 342, 526
- resultant, 134, 153–54, 158–59, 416
  - multipolynomial, 134, 154, 533
- reverse lexicographic order, *see* monomial ordering
- Reynolds operator, 336–37, 340
- Richman, F., 153, 178, 209, 538
- Riemann sphere, 369, 376
- ring,
  - commutative, 2, 218, 509
  - coordinate, of a variety ( $k[V]$ ), 239, 260, 349, 474, 477, 510
  - homomorphism, 165, 225, 243
  - integral domain, 218–19, 249, 260, 510
  - isomorphism, 250–51
  - of invariants, 331, 333
  - polynomial ( $k[x_1, \dots, x_n]$ ), 2
  - quotient ( $k[x_1, \dots, x_n]/I$ ), 221, 223, 260, 331, 510
- Robbiano, L., 75, 111, 533, 535–38
- robotics, 10–11, 265
- Rose, L., 532, 535
- Roth, L., 419, 538
- row-reduced echelon matrix, *see* echelon matrix
- Ruitenberg, W., 153, 178, 209, 538
- ruled surface, *see* surface, ruled
- S-polynomial**, *see* polynomial, S-
- secant line, *see* line, secant
- Sederberg, T., 134, 533, 535
- Segre, 393, 415–16
  - map, *see* mapping, Segre
  - variety, *see* variety, Segre
- Seidenberg, A., 178, 209, 538
- Semple, J. G., 419, 538
- Shafarevich, I. R., 474, 491, 538
- sign, of permutation, *see* permutation, sign of
- singular
  - point, *see* point, singular
  - quadric, *see* quadric, singular
- SINGULAR (program), *see* computer algebra systems
- singular locus, 490–91

- Siret, Y., 40, 43, 46, 153, 190, 536  
 Smith, L., 342, 538  
 solving equations, 49, 96, 236, 531  
 space  
   affine, 3  
   configuration (of a robot), 268  
   joint (of a robot), 269  
   orbit, 351, 353  
   projective, 360–61  
   quotient vector, 457  
   tangent, 485–89, 491, 492, 494–95  
 specialization of Groebner bases, *see*  
   Groebner basis, specialization of  
 stabilizer, 355  
 Stillman, M., 75, 112, 122, 520, 531, 535  
 strophoid, 25  
 Sturmfels, B., ix, 112, 302, 340, 342, 345,  
   532, 537, 538  
 subgroup, 511  
 subring, 331  
 subvariety, 239  
 sugar, 111, 526  
 surface  
   Enneper, 135  
   hyperboloid of one sheet, 251  
   intersection, 532  
   ruled, 101, 416  
   tangent, to the twisted cubic, 20, 100,  
     128, 131, 135, 375  
   Veronese, 393, 404  
   Whitney umbrella, 136  
 Sutor, R., 519, 537  
 symmetric polynomial, *see* polynomial,  
   symmetric  
 syzygy, 36, 105–07, 112–13, 346  
   homogeneous, 106–07, 113  
   ideal, 346  
**Tangent**, 507  
   cone, *see* cone, tangent  
   line to a curve, *see* line, tangent  
   space to a variety, *see* space, tangent  
 Taylor's formula, 486, 487, 496  
 term, 2  
 tetrahedron, 335  
 Theorem  
   Affine Dimension, 461  
   Bezout's, 357, 422–37  
   Circle, of Apollonius, 295, 302, 306,  
     311, 313  
   Classification, for Quadrics, 411  
   Closure, 123, 125–28, 130, 193, 258  
   Dimension, 461  
   Elimination, 116–18, 120–22, 130–31,  
     145, 188, 395, 402  
   Extension, 115, 162–66, 394  
   Fermat's Last, 13  
   Fundamental, of Algebra, 4, 165, 172,  
     320  
   Fundamental, of Symmetric  
     Polynomials, 319–24  
   Geometric Extension, 125–27, 171,  
     394–95, 404  
   Hilbert Basis, 14, 31, 75–81, 95, 169,  
     207, 209, 227, 339, 343, 380,  
     403  
   Implicit Function, 291, 492  
   Intermediate Value, 433, 436  
   Isomorphism, 346, 494  
   Lasker-Noether, 212  
   Molien's, 340, 345, 532  
   Noether's, 338, 343  
   Normal Form for Quadrics, 411–18  
   Pappus's, 304–06, 365–66, 437  
   Pascal's Mystic Hexagon, 434  
   Polynomial Implicitization, 349  
   Projective Extension, 398  
   Pythagorean, 293  
   Rational Implicitization, 134  
 Tournier, E., 40, 43, 153, 190, 536  
 Trager, B., 178, 209, 537  
 transcendence degree, 482, 484  
 transformation  
   affine, 277  
   projective linear, 409  
 Traverso, C., 111, 533  
 triangular form, 309  
 twisted cubic  
   curve, *see* curve, twisted cubic  
   tangent surface of, *see* surface, tangent  
 Unique factorization of polynomials, 150  
 uniqueness question in invariant theory,  
   333, 335, 345–46

- Van Dam, A.**, 533, 536  
**van der Waerden, B.**, 159, 538  
 vanishing point, *see* point, vanishing  
 variety  
   affine, 5  
   dual, 356  
   irreducible, 198–99, 201, 204, 206–07,  
     214, 221, 249, 257, 264, 299, 309,  
     356, 443, 473–74  
   irreducible component of, 305, 490–92,  
     495, 503, 507  
   linear, 9, 371  
   minimum principle, 264  
   of an ideal ( $\mathbf{V}(I)$ ), 79, 380  
   projective, 371  
   rational, 254, 256  
   reducible, 218  
   Segre, 393  
   subvariety of, 245  
   unirational, 17  
   zero-dimensional, 236  
**Vasconcelos, W.**, 178, 209, 536  
**Veronese surface**, *see* surface,  
   Veronese  
**Walker, R.**, 429, 433–34, 538  
**Wang, D.**, 314–15, 532, 538  
**Warren, J.**, 159, 532–33, 535–36  
 weight order, *see* monomial ordering  
 weighted homogeneous polynomial, *see*  
   polynomial, weighted homogeneous  
 weights, 405  
**Weispfenning, V.**, 83, 111, 178, 188, 283,  
   529, 534–35  
**Wensley, C.**, 522  
 well-ordering, 55–57, 65, 72  
**Whitney umbrella**, *see* surface, Whitney  
   umbrella  
**Wiles, A.**, 13  
**Winkler, F.**, 112, 539  
**Wolfram, S.**, 524, 539  
**Wu's Method**, 307–15  
**Wu, W.-T.**, 307, 315, 532, 539  
  
**Zacharias, G.**, 178, 209, 537  
**Zariski**  
   closure, *see* closure, Zariski  
   dense set, 502  
**Zelevinsky, A.**, 159, 537

## Undergraduate Texts in Mathematics *(continued from p.ii)*

---

- Iooss/Joseph:** Elementary Stability and Bifurcation Theory. Second edition.
- Irvig:** Integers, Polynomials, and Rings: A Course in Algebra.
- Isaac:** The Pleasures of Probability. Readings in Mathematics.
- James:** Topological and Uniform Spaces.
- Jänich:** Linear Algebra.
- Jänich:** Topology.
- Jänich:** Vector Analysis.
- Kemeny/Snell:** Finite Markov Chains.
- Kinsey:** Topology of Surfaces.
- Klambauer:** Aspects of Calculus.
- Lang:** A First Course in Calculus. Fifth edition.
- Lang:** Calculus of Several Variables. Third edition.
- Lang:** Introduction to Linear Algebra. Second edition.
- Lang:** Linear Algebra. Third edition.
- Lang:** Short Calculus: The Original Edition of "A First Course in Calculus."
- Lang:** Undergraduate Algebra. Third edition.
- Lang:** Undergraduate Analysis.
- Laubenbacher/Pengelly:** Mathematical Expeditions.
- Lax/Burstein/Lax:** Calculus with Applications and Computing. Volume 1.
- LeCuyer:** College Mathematics with APL.
- Lidl/Pilz:** Applied Abstract Algebra. Second edition.
- Logan:** Applied Partial Differential Equations, Second edition.
- Logan:** A First Course in Differential Equations.
- Lovász/Pelikán/Vesztegombi:** Discrete Mathematics.
- Macki-Strauss:** Introduction to Optimal Control Theory.
- Malitz:** Introduction to Mathematical Logic.
- Marsden/Weinstein:** Calculus I, II, III. Second edition.
- Martin:** Counting: The Art of Enumerative Combinatorics.
- Martin:** The Foundations of Geometry and the Non-Euclidean Plane.
- Martin:** Geometric Constructions.
- Martin:** Transformation Geometry: An Introduction to Symmetry.
- Millman/Parker:** Geometry: A Metric Approach with Models. Second edition.
- Moschovakis:** Notes on Set Theory. Second edition.
- Owen:** A First Course in the Mathematical Foundations of Thermodynamics.
- Palka:** An Introduction to Complex Function Theory.
- Pedrick:** A First Course in Analysis.
- Peressini/Sullivan/Uhl:** The Mathematics of Nonlinear Programming.
- Prenowitz/Jantosciak:** Join Geometries.
- Priestley:** Calculus: A Liberal Art. Second edition.
- Protter/Morrey:** A First Course in Real Analysis. Second edition.
- Protter/Morrey:** Intermediate Calculus. Second edition.
- Pugh:** Real Mathematical Analysis.
- Roman:** An Introduction to Coding and Information Theory.
- Roman:** Introduction to the Mathematics of Finance: From Risk Management to Options Pricing.
- Ross:** Differential Equations: An Introduction with Mathematica®. Second edition.
- Ross:** Elementary Analysis: The Theory of Calculus.
- Samuel:** Projective Geometry. *Readings in Mathematics.*
- Saxe:** Beginning Functional Analysis.
- Scharlau/Opolka:** From Fermat to Minkowski.
- Schiff:** The Laplace Transform: Theory and Applications.
- Sethuraman:** Rings, Fields, and Vector Spaces: An Approach to Geometric Constructability.
- Sigler:** Algebra.
- Silverman/Tate:** Rational Points on Elliptic Curves.
- Simmonds:** A Brief on Tensor Analysis. Second edition.
- Singer:** Geometry: Plane and Fancy.
- Singer:** Linearity, Symmetry, and Prediction in the Hydrogen Atom.
- Singer/Thorpe:** Lecture Notes on Elementary Topology and Geometry.
- Smith:** Linear Algebra. Third edition.
- Smith:** Primer of Modern Analysis. Second edition.
- Stanton/White:** Constructive Combinatorics.
- Stillwell:** Elements of Algebra: Geometry, Numbers, Equations.
- Stillwell:** Elements of Number Theory.
- Stillwell:** The Four Pillars of Geometry.
- Stillwell:** Mathematics and Its History. Second edition.
- Stillwell:** Numbers and Geometry. *Readings in Mathematics.*
- Strayer:** Linear Programming and Its Applications.
- Toth:** Glimpses of Algebra and Geometry. Second edition. *Readings in Mathematics.*
- Troutman:** Variational Calculus and Optimal Control. Second edition.
- Valenza:** Linear Algebra: An Introduction to Abstract Mathematics.
- Whyburn/Duda:** Dynamic Topology.
- Wilson:** Much Ado About Calculus.